

AUTOMATIC
DISTRIBUTORS

SERVICE CATALOG



STREET | OFFROAD | ATV/UTV | TRAILER | SNOW | PWC

MISSION STATEMENT



To intently engage our customers and build our experience from the opinions of those trusted partners, becoming the trusted choice.



ABOUT OUR COMPANY



For more than six decades, we have been a leading distributor of parts and accessories to powersports dealers nationwide. Boasting an extensive selection of over 85,000 products from more than 350 top brands, Automatic is renowned for delivering exceptional service with the passion and professionalism that today's powersports dealers require.

WHOLESALE



As a dedicated wholesale-centric company, we assure you that direct customer sales are not in our practice. Our commitment lies in fostering robust wholesale relationships and providing an unparalleled experience exclusively to esteemed powersports dealers worldwide.

SERVICE



At our core, we prioritize the individual needs and aspirations of each of our esteemed dealers and vendors. Understanding that success in this dynamic industry cannot be achieved through a generic, 'one size fits all' approach, we focus on building bespoke solutions. Our collaborative efforts are aimed at closely understanding and aligning with your unique requirements, ensuring that the service we deliver is not just effective, but also specifically tailored to propel your success. By nurturing these personalized partnerships, we aim to contribute significantly to your growth and achievements in the powersports landscape.

DEALER CARE



Automatic proudly supports its extensive network of over 7,500 dealers with a variety of resources designed for their success. Our dealers benefit from our advanced 24/7 online account management tools and the expertise of our knowledgeable sales team, ensuring top-notch support from the very beginning. Additionally, our industry-leading late same-day shipping cutoff times provide an extra edge in efficiency and service.

OUR HISTORY

1965 HUMBLE BEGINNINGS BREWSTER, MAINE

The new home to Twin City Marine founded by John R Graham III. John's visionary focused on the winter months by catering to the snowmobile market and founded Twin City Distributors.

1992 PART OF THE TEAM

After the mid 80's Twin City Distributors became Automatic Distributors. Established the SPI buying group with Marshalls, WPS, and Bell & BCS.

1995 EXPANSION

Automatic Distributors expanded from snowmobile into the small utility trailer parts segment, bringing in more customers and products.

2000 ATVS AND MORE!

Automatic Distributors expanded again to include another parts segment to their business when ATV parts were added into their ever growing catalog.

2004 GROWING MARKET

Automatic Distributors added on to their growing catalog by adding Dirt Bike and UTV parts by making those available to their expanding dealer customer base.

2010 FAMILY VALUES

Founder, John Graham III retired, passing the torch to his son, Jeff Graham who took over operations and expanded to add Street / Cruiser parts and 100 new vendors.

2012 MORE LOCATIONS

Opened up a facility in Indianapolis, giving the company a one day foot print to cover 60 million people and a two day footprint to cover the needs of 230 million people.

2013 MARINE EXPANSION

With staying true to our roots, we added an all-new marine book to expand servicing some of the top marine dealers in the region.

2014 SALES FORCE

After largely increasing our number of partners from Jeff Graham's efforts, he continued with expanding the Automatic sales force to further support our global dealer network.

2018 AUTOMATION

With dealer support as a priority, Automatic heavily invested in increasing our IT infrastructure. As a result, we delivered increased efficiency and convenience for our dealer network.

2019 DEALER SUPPORT

2019 brought additional automation services which has allowed our team to increase daily order volume and maintain our industry leading same day shipping cutoff time.

2020 MAKING HISTORY

For the past decade, Jeff Graham has led Automatic Distributors in the motorcycle, off-road, snow, marine, and trailer markets. This company is stronger than ever!

2022 MOVING WEST

The launch of Automatic's new west coast distribution center marks a significant milestone. Spanning over 80,000 square feet, this facility not only offers rapid 1 - 2 day delivery services to our west coast customers but also accommodates our plans for future expansion.

2023 SALES EXPANSION

Our team grew significantly, extending our reach across the nation to provide better service and support to our customers. Additionally, we were immensely excited to unveil our new innovative dealer website, a platform specifically developed to heighten customer interaction and improve overall user experience.

2024 SCALING UP

In the early days of 2024, we proudly expanded our portfolio by introducing eight new premium brands. We also had the opportunity to prominently feature our products and services at AIME, the renowned industry expo trade show, held in Las Vegas.

OUR SERVICES



We are dedicated to our customers, who are like family to us. With this approach in mind, we are well known in the industry for our exceptional service and for meeting the demands of the power sports industry with passion and professionalism. Our extensive team of vendors provide high quality parts that align with our vision of offering the best to our customers. We stand by what we do and the outstanding service we provide, our family business takes pride in our ability to go above and beyond to care for our dealer network and customers.

Industry Leading Shipping

Automatic proudly offers the industry's latest cutoff times for same-day shipping, a commitment that underscores our dedication to providing our dealer network with exceptional support. This capability ensures that our dealers can rely on us for quick and efficient order fulfillment, helping them to meet their business needs and customer expectations with unparalleled speed and efficiency.

Private Reserve

Setting a new standard in the industry, Automatic uniquely provides reserve inventory options for dealers. Whether it's for weekly or monthly stock requirements, place your order with us, and we'll handle the fulfillment. Acting as an extended warehouse, we guarantee that our dealers are always equipped to meet their customers' needs efficiently.

Service

From day one our primary focus has been customer service. Our dedication to this is shown with how we mold to the individual needs of our partners. We are in this together.

Automation

With the rapidly changing landscape of large-scale distribution, our investments into technology have vastly increased our automation efforts, leading to a near 100% order accuracy rate and preparing us for the future of distribution.



AUTOMATIC

BY THE NUMBERS



Automatic maintains a lean operation with significant investments in key areas, ensuring exceptional agility. This approach empowers us to not only respond effectively to the needs of our customers and vendors but also to swiftly adapt to evolving market conditions.

99%+

SHIPPING ACCURACY

Our customers trust in our reliability, knowing that when they place an order with us, it will be fulfilled with near-perfect accuracy. Our commitment to excellence is supported by significant investments in advanced technology and automation, enhancing our efficiency and precision. This dedication to accuracy and detail positions us as one of the leading distributors nationwide, renowned for our dependable and precise service.

350+

BRANDS

At our company, we take immense pride in representing a diverse portfolio of over 350 distinct brands. Each brand in our collection is carefully selected for its quality, innovation, and alignment with our commitment to excellence. Our extensive range ensures that we offer a wide variety of products to meet the varied needs and preferences of our customers, further solidifying our reputation as a trusted and versatile distributor in our industry.

85k

CURRENT DATA

We are proud to distribute an impressive array of over 85,000 SKUs, providing an immense asset to our dealer network. This extensive selection ensures that our dealers have access to a vast range of products, catering to all their needs and preferences. Our comprehensive inventory not only enhances their product offerings but also reinforces their ability to meet customer demands promptly and effectively, solidifying their position in the market.

OUR CATALOGS

OUTERWEAR

Automatic is proud to present our diverse range of catalogs, each tailored to a specific sector of the power sports industry. Our extensive collection includes seven specialized catalogs: Outerwear, Snowmobile, Off Road, UTV/ATV, Marine, Street, and Trailer. Each catalog is a comprehensive guide, showcasing a wide array of products and accessories designed to meet the unique needs of each segment. From the latest in high-performance gear to essential equipment, our catalogs provide an in-depth look at the quality and variety we offer. This specialization ensures that, no matter your focus in the power sports arena, Automatic has the resources and products to support your business's success.

WINTER

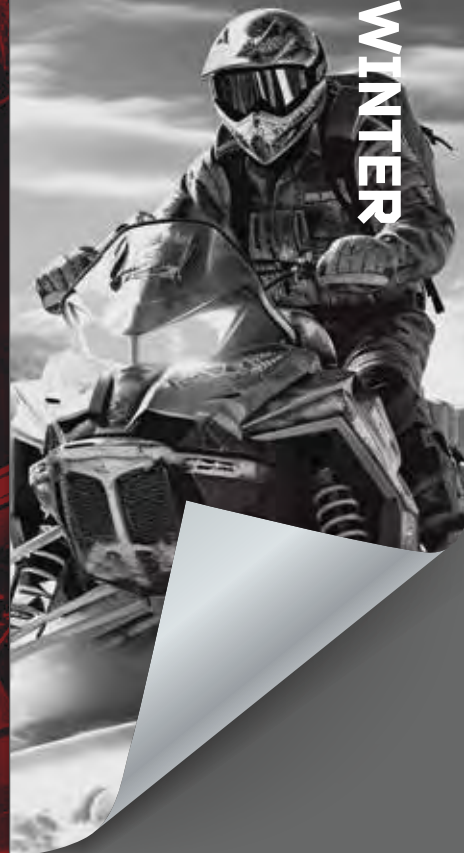

MARINE



ATV



MOTO



TRAILER



UTV



STREET



Each of our catalogs are made available to our dealers, as well as on our website. If you visit our website, be sure to check out our interactive catalogs, turn the pages like you would as if you were holding it!



GET READY FOR YOUR NEXT ADVENTURE!



Discover the ultimate destination for all your powersports needs at Autodist.com. Our newly revamped website is tailored for dealers in the powersports industry, offering a seamless and dynamic online experience. Dive into a world where performance meets reliability, and every click brings you closer to the thrill of the ride. Autodist.com is more than just a website; it's a gateway to ignite your passion for powersports. Start your adventure with us today and experience the difference!

What's New?

- Sleek and User-Friendly Interface
- Hot Deals and Exclusive Offers
- Expanded Product Catalog
- Mobile-Friendly Experience

Why Autodist.com?

- Unparalleled Expertise
- Partnerships with Leading Brands
- Global Reach, Local Touch

www.autodist.com

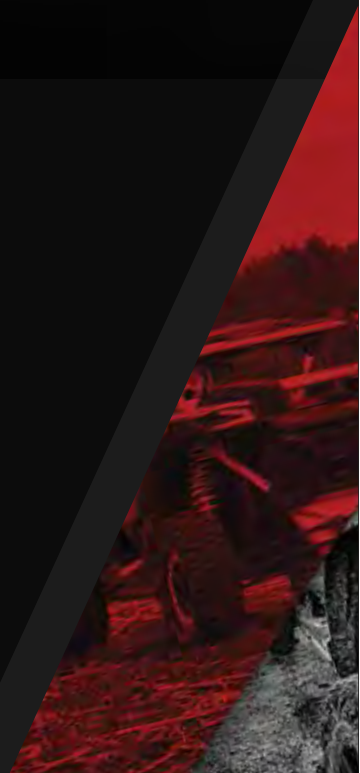

RETURN & SHIPPING POLICY



At Automatic, we understand the importance of flexibility and convenience for our partners. To ensure your utmost satisfaction, we offer a hassle-free returns policy. Our partners can return products up to 60 days from the date of purchase, provided the items are in new, resalable condition. Simplifying the process further, we require no Return Goods Authorization (RGA), making it easier and more efficient for you to manage your inventory. This policy is a testament to our commitment to providing a seamless and supportive experience, ensuring that your focus remains on growing your business without worrying about the complexities of returns and shipping.

At Automatic, we set the standard in the power sports industry with our exceptional shipping policy. We understand that time is of the essence in your business, which is why we offer the latest same-day shipping cut-offs in the industry. Place your orders as late as 5 PM EST or 4 PM PST, and rest assured that your products will be shipped the very same day. This commitment to expedience is matched by our remarkable accuracy rate, which exceeds 99%. Our meticulous approach to order fulfillment means that you receive exactly what you need, when you need it, with virtually no errors. Trust Automatic for shipping that's not just fast, but also precise and reliable.



AUTOMATIC

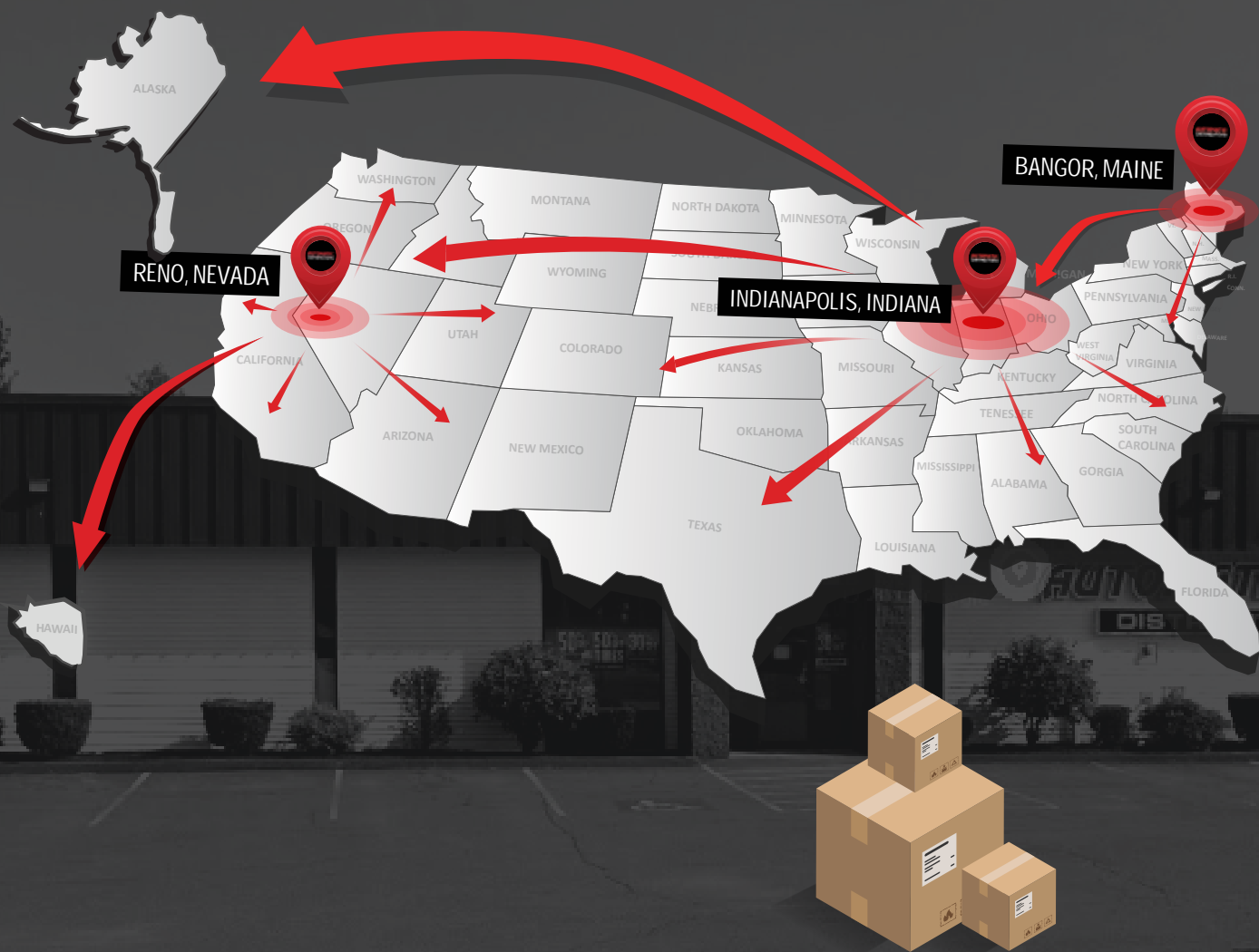

OUR REACH

Over 7k

Automatic Distributors takes pride in partnering with over 7,500 dealers throughout the United States.

Check out our customer base and transit maps

MAKING THE RIGHT CHOICE



EXPERIENCE

With over 60 years of rich history, Automatics has established itself as a reliable and seasoned partner in the power sports industry. Our extensive experience is a testament to our commitment and expertise, ensuring we are the ideal choice for your business needs.

SERVICE

At Automatic, we pride ourselves on providing unparalleled service that meets the fast-paced demands of the power sports industry. With our cutting-edge same-day shipping system, orders are processed with exceptional speed, ensuring that your needs are met promptly. Our efficient logistics network allows us to deliver products across the nation within just 1 to 2 days. This swift and reliable delivery service is part of our commitment to ensuring that your business runs smoothly and efficiently, with minimal downtime. Trust Automatic for service that is as rapid as it is dependable.

FREIGHT

In the power sports industry, Automatic leads the way with the most advanced same-day shipping cutoff times. Our cutoff is set at 5 PM EST and 4 PM PST, and we operate 6 days a week, ensuring that dealers receive their products swiftly. This efficiency means your inventory is replenished faster, allowing your products to be on the shelves and available to your customers quicker than ever!





TABLE OF CONTENTS

TIRES & TRACKS	4-175
TUBES	176-191
CHEMICALS	192-295
TOOLS	296-429
BATTERIES	430-473
FUEL & INTAKE	474-535
AIR & OIL FILTER	536-539





TABLE OF CONTENTS

STREET	6-57
OFFROAD	58-103
ATV/UTV	104-153
TRAILER	154-159
TRACKS	160-175

STREET

TABLE OF CONTENTS

BRIDGESTONE	7-29
CONTINENTAL	30-37
KENDA	38-47
PIRELLI	48-57

1000 CC 600 CC 400 CC 250 CC 150 CC

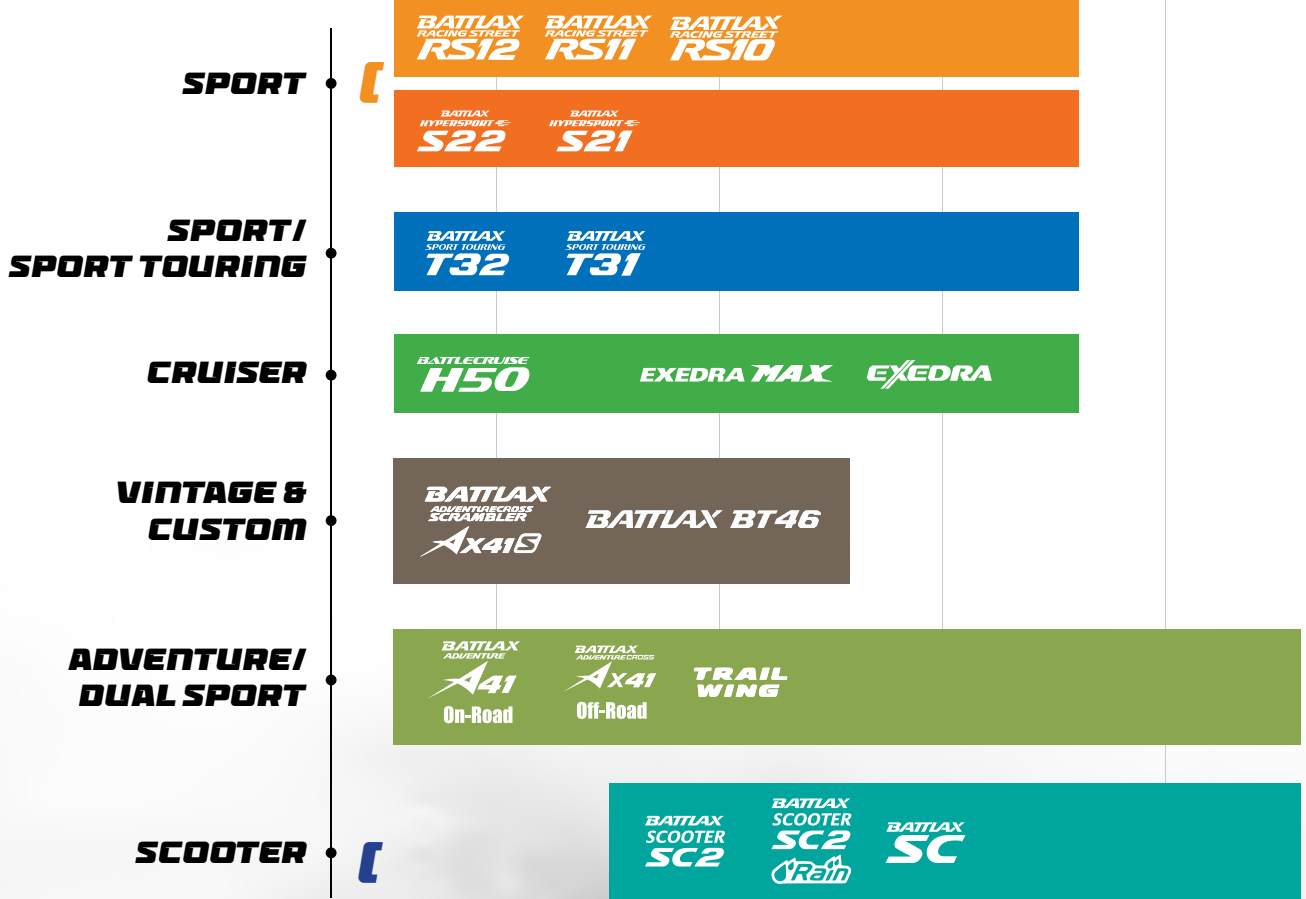

MS-BELT

MSB construction means that a continuous single strand is wrapped around the circumference of the tire. This one-piece construction eliminates overlapping of belts, seams, and joints. A MSB tire is lighter than conventional multi-cross belt construction, it has more stability since it minimizes heat generation inside the tire and gives high shock absorption.



V-MS-BELT

Optimization of the spacing of the MS•BELT cords coiled around the tire's circumference contributes to ideal tire contact properties, as well as enhanced grip and performance.



ULTIMATE EYE

Visualization of the tire contact patch behavior with measurement and simulation technology. Supplies less slip area for good traction while riding and improves wear life.



CAP & BASE

The underlying layer controls tread stiffness, reinforcement and assists with bump absorption.



3D CTDM

3D CTDM is Bridgestone's newest automated tire design technology. This leading edge 3D CTDM program enables Bridgestone to conduct dynamic, three-dimensional simulations and analysis of tire performance, in addition to finding optimum solutions at all lean angles.



HTSPC

Bridgestone was the very first motorcycle tire manufacturer to utilize 1X5 filament rubber insulated steel (MSB) in the manufacture of its motorcycle radial tires. This technology offers many advantages over steel that is used by the competition. This makes the tire more flexible, provides more stability without a reduction in shock absorption, and minimizes the generation of heat throughout the tire.

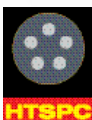

RC POLYMER

RC Polymer technology optimizes the distribution of silica within the rubber compound and improves tread flexibility allowing greater contact with the road surface in both hot and cold conditions. The reduction in molecular friction also improves rolling resistance, therefore increasing fuel economy.



OUTSIDE BEAD FILLER

The latest generation outside bead filler realizes the ideal sidewall profile analyzed by a finite element method by giving optimum force distribution and rigidity balance.



NANO PRO-TECH

NanoPro-Tech is the name of a technology that facilitates the realization of the required features in a tire by controlling the material microstructure through structural design at the molecular level. It is one of Bridgestone's fundamental technologies.



SILICA RICH

Silica Rich Compound provides enhanced gripping capability in wet conditions and low temperatures; ensuring superb handling at the beginning of every ride. It also provides a more consistent and longer lasting grip.



SILICA RICH EX

Performance in wet conditions is improved by increasing the amount of silica compared to conventional SILICA RICH.



3LC (DUAL COMPOUND)

Provides grip performance demanded in all riding modes. The center compound offers linear handling. The shoulder compound secures high grip and solid contact feel.



3LC + CAP & BASE

The CAP&BASE construction divides the shoulder of the compound of the tire into upper and lower sections. By using a high grip compound for the upper section of the shoulder, and a high stability abrasion resistant compound for the lower and central sections, provides the desired combination of both performance and mileage.



5LC (TRIPLE COMPOUND)

Offers ideal grip performance demanded in all riding modes. The center compound provides good stability. The shoulder compound transfers engine power to the road with strong traction. The edge compound offers strong side grip and solid contact feel at deep lean angles.



The Bridgestone Battlax Racing Street RS12 is a pinnacle road-legal hypersport tire, engineered with elite racing technology for modern superbikes. Designed to provide a near-slick feel, it offers a significant leap in dry grip and feedback over previous generations.

- **Advanced Grip:** Features MotoGP-derived compounds for the highest dry traction in the Battlax street lineup.
- **HE-MS Belt:** Utilizes a flexible belt structure to equalize contact pressure, improving stability and braking.
- **Track Ready:** Reaches optimal operating temperature rapidly without needing tire warmers.
- **Precision Handling:** The revised tread pattern maximizes the contact patch at high lean angles.
- **Speed Rated:** Rated (W) for high-performance motorcycles, delivering consistent lap-after-lap stability.



FRONT

REAR

TECHNICAL FEATURES



SIZES	LOAD SPEED	TIRE CONSTRUCTION & PATTERN	OVERALL DIAMETER	TREAD WIDTH	OTD 32NDS	(MEASURING RIM) APPROVED RIM	MAX P.S.I.	PART #
<i>FRONT</i>								
120/70ZR17M/C	58W	BATTLAX RACING STREET RS12F	23.7	4.8	4	(3.50) 3.50~3.50	41	835608
<i>REAR</i>								
180/55ZR17M/C	73W	RS10R BW TL	24.8	7.2	7	(5.50) 5.50~6.0	42	835609
190/55ZR17M/C	75W	RS10R BW TL	25.5	7.5	6	(6.0) 5.50~6.0	42	835610
200/55ZR17M/C	78W	RS10R BW TL	25.8	7.9	6	(6.25) 6.00~6.50	42	835611



FAST SAME DAY SHIPPING

BATTLAX RACING STREET RS11

Enhance the ride of your liter bike with Bridgestone's flagship sport tire. The Battlax Racing Street RS11 is built with technology derived from the highest levels of racing. Whether you are chasing lap times, or riding your favorite winding road, enjoy Bridgestone's most aggressive street sport tire.

- Increased cornering grip and stability, with improved rider feedback:
 - The RS11 is the first road-oriented tire that has adopted the new V-MS-Belt construction in the rear which is currently used in Bridgestone's highest performing race tires. This significantly improves the contact area with the road surface, enhancing cornering grip.*
 - A new molecular approach of fine carbon particles in terms of compounding has improved the bite to the road surface and enhanced the grip characteristics of the compound itself.*
 - New 3LC compounds on the front and rear create greater grip, increased cornering stability, and improved rider feedback. No sacrifice to straight line stability.*
- Groove pattern inspired by the BATTMAX Racing R11: Design adaptations make it an incredibly capable track tire, while still maintaining street tire performance.
- Increased wet performance: Enhanced water dispersion due to new groove design
- 1.9 seconds faster per 2 minute lap*
- Sizing for modern liter bikes
- DOT Approved (No warmers needed)

* Disclaimer: Comparison based on Battlax Racing Street RS11 tire versus Battlax Racing Street RS10 tire from internal testing. Results may vary.



FRONT

REAR

TECHNICAL FEATURES



*Rear Only

*Rear Only

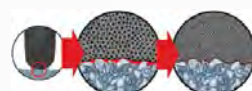

A new molecular approach of fine carbon particles in terms of compounding has improved the bite to the road surface and enhanced the grip characteristics of the compound itself.

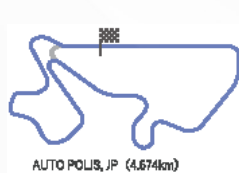

AUTO POLIS, JP (4.674km)

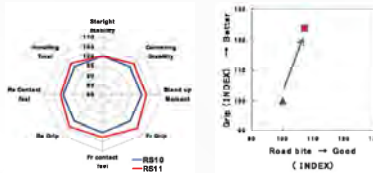

SIZES	LOAD SPEED	TIRE CONSTRUCTION & PATTERN	OVERALL DIAMETER	TREAD WIDTH	OTD 32NDS	(MEASURING RIM) APPROVED RIM	MAX P.S.I.	PART #
FRONT								
120/70ZR17M/C	58W	RS11F BW TL	23.66	4.69	4.38	(3.50) 3.50~3.75	42	835375
REAR								
190/55ZR17M/C	75W	RS11R BW TL	25.55	7.4	6.16	(6.00) 5.50~6.00	42	835376
200/55ZR17M/C	78W	RS11R BW TL	25.83	7.76	6.16	(6.25) 6.00~6.50	42	835377

- High-performance sport radials optimized for high-grip and handling performance on dry surfaces.
- Bridgestone's MotoGP development analysis was used to determine the placement of new 3-D tread grooves to improve stability, grip and handling by optimizing block stiffness.
- Specially formulated rubber compounds front and rear offer sure grip as well as increased durability.
- RS10 (front) uses a Mono-Spiral Belt constructed with stiffer steel to enhance rigidity of the tread area for upgraded response and stability.
- Cap and Base (rear) adds tread stiffness for stability when braking and accelerating.
- Softer sidewall construction (rear) incorporated for better damping to improve handling.
- Compares to: Michelin Power Supersport, Pirelli Rosso Corsa, Metzeler Racetec K3.

*All comparisons made to Bridgestone BT-003RS Ultra-High Performance Sport Radial

Recommended for:

- Riders who wish to enjoy riding over a wide range from the racing track to the winding road.
- Riders who want sporty and high kinetic performance on dry roads.
- Riders who are seeking higher grade dry performance than S21/S20EVO.



FRONT

REAR

TECHNICAL FEATURES



- *1: All Rear Sizes
- *2: All Rear Sizes
- *3: Front

Tread pattern



- ① The groove is placed along the entering direction at cornering
⇒ Reinforced block rigidity
- ② Tread transformation to create an independent groove
⇒ Warm up time shortened
- ③ Reinforced block rigidity due to the 3D groove shape
⇒ Improved stability when braking and accelerating

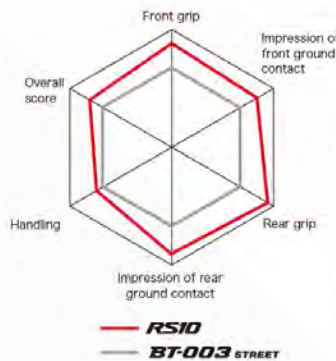

Pattern rigidity



Circuit lap time



[Test conditions]
 Test location : Autopolis Circuit, Japan (4.674km),
 June 23,24, 2014
 Test vehicle : BMW S1000RR
 Tire size : 120/70ZR17, 190/55ZR17
 Air pressure : front 230kPa, rear 250kPa
 Rider : Bridgestone Test Rider

SIZES	LOAD SPEED	TIRE CONSTRUCTION & PATTERN	OVERALL DIAMETER	TREAD WIDTH	OTD 32NDS	(MEASURING RIM) APPROVED RIM	MAX P.S.I.	PART #
FRONT								
110/70ZR17 M/C	(54H)	RS10F BW TL	23.27	4.29	4	(3.00) 3.00~3.50	41	835369
120/70ZR17M/C	(58W)	RS10F BW TL	23.6	4.7	4	(3.5) 3.0~3.5	42	835370
REAR								
140/70ZR17 M/C	(66H)	RS10R BW TL	24.69	5.71	6	(3.75) 3.75~4.50	41	835372
150/60R17	(66H)	RS10R BW TL	24.69	6.1	6	(4.50) 4.00~4.50	41	835371
180/55ZR17M/C	(73W)	RS10R BW TL	25.2	7.2	6	(5.5) 5.5~6.0	42	835373
190/50ZR17M/C	(73W)	RS10R BW TL	24.9	7.5	6	(6.0) 5.5~6.0	42	835374

BATTLAX HYPERSPORT S23

The Battlax Hypersport S23 is Bridgestone's ultimate hypersport tire designed to amplify your riding experience with exhilarating performance and precision control. Delivering improvements over the the Battlax Hypersport S22, the S23 is a next generation tire that's engineered for increased wet and dry grip, plus cornering stability without compromising wear for more time carving up the road.

- New tread compound on front shoulder and rear edge to enhance dry grip.
- New pattern design implements Pulse Groove technology to increase water drainage and grip in wet conditions.
- Optimized pattern stiffness supports improved traction and stability.

Name	BATTLAX HYPERSPORT S23 BATTLAX HYPERSPORT S23	
Sizes	Six sizes (one front size, five rear sizes)	
	Front	120/70ZR17M/C (58W) TL
	Rear	160/60ZR17M/C (69W) TL
		180/55ZR17M/C (73W) TL
		190/50ZR17M/C (73W) TL
		190/55ZR17M/C (75W) TL
		200/55ZR17M/C (78W) TL
Launch	January 2024	



FRONT

REAR

TECHNICAL FEATURES



SIZES	LOAD SPEED	TIRE CONSTRUCTION & PATTERN	OVERALL DIAMETER	TREAD WIDTH	OTD 32NDS	(MEASURING RIM) APPROVED RIM	MAX P.S.I.	PART #
FRONT								
120/70ZR17M/C	58 W	Battlax Hypersport S23F	23.66	5	4	(3.50) 3.5~3.5	41	835582
110/70R17M/C	54 H	Battlax Hypersport S23F	23.2	4.3	5	(3.0) 3.5~3.0	41	835605
REAR								
140/70R17M/C	66 H	Battlax Hypersport S23R	24.7	5.5	7	(4.0) 4.0~3.75	41	835606
150/60R17M/C	66 H	Battlax Hypersport S23R	24.3	6.1	7	(4.0) 4.50~4.25	41	835607
160/60ZR17M/C	69 W	Battlax Hypersport S23R	24.8	8	7	(4.50) 4.50~5.00	41	835583
180/55ZR17M/C	73 W	Battlax Hypersport S23R	24.88	8	7	(5.5) 5.5~6.00	41	835584
190/50ZR17M/C	73 W	Battlax Hypersport S23R	24.72	8	8	(4.5) 4.25~5	42	835585
190/55ZR17M/C	75 W	Battlax Hypersport S23R	25.51	7	8	(5.5) 5.5~6	42	835586
200/55ZR17M/C	78 W	Battlax Hypersport S23R	25.87	7	7	(5.0) 5.0~5.5	41	835587

The BATTLAX HYPERSPORT S22 is Bridgestone's premier tire for the modern street sport bike. Starting where the S21 left off, the S22 has improved both the compounds and pattern design, to promote better handling in all conditions, without compromising wear.

- New front and rear compound improves the S22's dry grip*
- New front and rear pattern design, and a new rear compound improves the overall wet grip*
- Improved handling response due to increased pattern rigidity*

By optimizing the compounding of the resin, dry grip has been improved though a wider temperature range. This provides a higher level of sports riding performance.



FRONT

REAR

TECHNICAL FEATURES

Applied Technology



① New pattern: design Front & Rear ② New compound: Front center & Rear Traction ③ New compound: Rear center

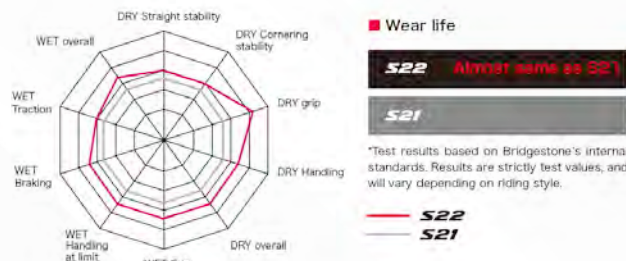

SIZES	LOAD SPEED	TIRE CONSTRUCTION & PATTERN	OVERALL DIAMETER	TREAD WIDTH	OTD 32NDS	(MEASURING RIM) APPROVED RIM	MAX P.S.I.	PART #
FRONT								
110/70R17M/C	54H	Battlax Hypersport S22	23.3	4.4	4	(3.0) 3.0~3.5	41	835389
120/70ZR17M/C	58(W)	Battlax Hypersport S22	23.7	4.7	5	(3.5) 3.5~3.75	42	835390
120/70ZR17M/C	58(W)	HAYABUSA 2022-PRESENT	23.7	4.7	5	(3.5) 3.5~3.75	42	835579
REAR								
140/70R17M/C	66H	Battlax Hypersport S22	25.5	7.2	7	(5.0) 5.0~5.5	41	835391
150/60R17M/C	66H	Battlax Hypersport S22	24.4	6.3	7	(4.25) 4.25~4.5	41	835392
160/60ZR17M/C	69(W)	Battlax Hypersport S22	24.8	6.4	8	(4.5) 4.25~5	42	835393
180/55ZR17M/C	73(W)	Battlax Hypersport S22	24.9	7.1	8	(5.5) 5.5~6	42	835394
180/60ZR17M/C	75W	Battlax Hypersport S22	25.5	7.2	7	(5.0) 5.0~5.5	41	835395
190/50ZR17M/C	73(W)	Battlax Hypersport S22	24.7	7.5	8	(6) 5.5~6	42	835396
190/50ZR17M/C	73(W)	HAYABUSA 2022-PRESENT	24.7	7.5	8	(6) 5.5~6	42	835580
190/55ZR17M/C	75(W)	Battlax Hypersport S22	25.5	7.6	7	(6) 5.5~6	42	835397
200/55ZR17M/C	78(W)	Battlax Hypersport S22	25.9	7.8	7	(6.25) 5.5~6.5	42	835398

BATTLAX SPORT TOURING T33

The Battlax Sport Touring T33 is Bridgestone's premium sport touring tire crafted to deliver effortless performance and extended tread life¹ for when you never want the road to end. As the next evolution of the Battlax Sport Touring T32, the T33 is engineered with responsive handling and enhanced wet and dry grip, inspiring confidence through every curve, rain or shine, so you can enjoy the journey ahead.

- Delivers up to 47% longer wear life for more ride time. ¹
- Enhanced compound technology delivers impressive grip on wet roads.
- New pattern design to combat wear degradation.
- Optimized pattern stiffness supports precise handling, straight-line stability and improved wear.

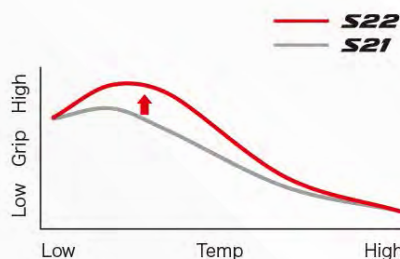

FRONT

REAR

TECHNICAL FEATURES

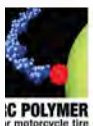
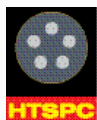

SIZES	LOAD SPEED	TIRE CONSTRUCTION & PATTERN	OVERALL DIAMETER	TREAD WIDTH	(MEASURING RIM) APPROVED RIM	PART #
FRONT						
110/80ZR18M/C	58W	BATTLAX SPORT TOURING T33F	25.0	4.3	(2.50)2.50~3.00	835601
110/80R19M/C	59V	BATTLAX SPORT TOURING T33F	26.1	5	(2.50)2.50~3.00	835589
120/70ZR19M/C	60W	BATTLAX SPORT TOURING T33F	25.7	4.8	(3.50)3.50~3.75	835602
120/70R19M/C	60V	BATTLAX SPORT TOURING T33F	25.7	5	(3.50)3.00~3.75	835590
120/70ZR17M/C	58W	BATTLAX SPORT TOURING T33F	23.7	5	(3.50)3.50~3.50	835591
120/70ZR18M/C	59W	BATTLAX SPORT TOURING T33F	24.8	5	(3.50)3.00~3.75	835592
120/60ZR17M/C	55W	BATTLAX SPORT TOURING T33F	22.9	4.7	(3.50)3.50~3.50	835600
REAR						
150/70ZR17 M/C	69W	BATTLAX SPORT TOURING T33R	25.2	9	(4.00)4.00~4.50	835593
160/70ZR17M/C	73W	BATTLAX SPORT TOURING T33R	25.8	6.3	(4.50)4.50~5.00	835603
160/60ZR18M/C	70W	BATTLAX SPORT TOURING T33R	25.5	6.3	(4.50)4.50~5.50	835604
160/60ZR17 M/C	69W	BATTLAX SPORT TOURING T33R	24.6	9	(4.50)4.50~5.00	835594
170/60ZR17 M/C	72W	BATTLAX SPORT TOURING T33R	25.1	9	(4.50)4.50~5.50	835595
180/55ZR17 M/C	73W	BATTLAX SPORT TOURING T33R	24.8	9	(5.50)5.50~6.00	835596
190/50ZR17 M/C	73W	BATTLAX SPORT TOURING T33	24.6	9	(6.00)5.50~6.00	835597
190/55ZR17 M/C	75W	BATTLAX SPORT TOURING T33	25.3	9	(6.00)5.50~6.00	835598

Following in the footsteps of the T31, the T32 takes a step forward by incorporating innovative new tread designs and rubber compounds to give sport touring riders the confidence to hit the road, rain or shine.

- Evacuates water more effectively with a new tread pattern featuring Pulse Groove Technology™ and Silica Rich compounds.*
- Increased cornering grip and improved feel from larger adhesion area provided by a 13% larger rear contact patch.*
- 7% shorter wet stopping distance with no sacrifice in wear life*
- Specific GT spec options for heavier bikes provides additional stability and 10% more wear life*
- GT Spec tires are recommend for bikes that have a dry weight above 500 lbs

(where applicable sizes exist)

*Comparison based on Battlax T32 tire versus Bridgestone Battlax T31 tire from internal testing. Results may vary.



FRONT

REAR

TECHNICAL FEATURES



SIZES	LOAD SPEED	TIRE CONSTRUCTION & PATTERN	LETTER CODE	OVERALL DIAMETER	TREAD WIDTH	OTD 32NDS	(MEASURING RIM) APPROVED RIM	MAX P.S.I.	PART #
FRONT									
110/70ZR17M/C	54W	BATTLAX SPORT TOURING T32F		23.23	5.4	5	(3.0) 2.75~3.5	42	835443
120/60ZR17M/C	55W	BATTLAX SPORT TOURING T32F		22.95	7.4	5	(3.5) 3.0~3.4	42	835444
110/80ZR18M/C	58W	BATTLAX SPORT TOURING T32F		25.04	4.3	5	(2.5) 2.5~3.0	42	835447
120/70ZR18M/C	59W	BATTLAX SPORT TOURING T32F	GT	24.76	4.8	5	(3.5) 3.0~3.5	42	835449
120/70ZR19M/C	60W	BATTLAX SPORT TOURING T32F		25.59	4.3	5	(3.5) 3.0~3.75	42	835452
REAR									
160/70ZR17M/C	73W	BATTLAX SPORT TOURING T32R		25.78	6.2	8	(4.50) 4.50~5.0	42	835455
180/55ZR17M/C	73W	BATTLAX SPORT TOURING T32R		24.76	6.5	8	(5.5) 5.5~6.0	42	835458
190/50ZR17M/C	73W	BATTLAX SPORT TOURING T32R		24.57	4.3	8	(6.0) 5.5~6.0	42	835460
140/70ZR18M/C	67V	BATTLAX SPORT TOURING T32R		25.71	4.8	9	(4.0) 3.5~4.5	42	835463
160/60ZR18M/C	70W	BATTLAX SPORT TOURING T32R		25.51	4.8	8	(4.5) 4.5~5.0	42	835464

BATTLECRUISE H50

Built specifically for the American V-Twin, the Battlecruise H50 tire provides great handling on both wet and dry surfaces, with excellent mileage and tread wear.

- Compounds and profiles designed to offer the optimal balance of handling, mileage and ride comfort.
- Optimized tread pattern for high powered American V-Twins with attractive diamond cross deco-groove.
- Get 50% better rear tire wear than Dunlop D401*.
- Profile designed for easier steering and ride quality for long distance riding.
- Compares to: Dunlop American Elite, Michelin Commander III, Pirelli Night Dragon, Metzeler CruiseTec.



TECHNICAL FEATURES

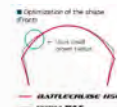
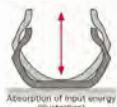

FRONT

REAR

SIZES	LOAD SPEED	TIRE CONSTRUCTION & PATTERN	OVERALL DIAMETER	TREAD WIDTH	OTD 32NDS	(MEASURING RIM) APPROVED RIM	MAX P.S.I.	PART #
FRONT								
130/90B16M/C	67H	Battlecruise H50F TL	25.2	5.1	5	(3.5) 2.5~3.5	41	835309
130/90B16M/C	73H	Battlecruise H50F RFD TL	25.2	5.1	5	(3.5) 2.5~3.5	48	835310
130/90B16M/C	73H	Battlecruise H50F RFD TL	25.2	5.1	5	(3.5) 2.5~3.5	48	835311
100/80-17M/C	52H	Battlecruise H50F	23.4	4.1	5	2.5	42	835312
130/80B17M/C	65H	Battlecruise H50F TL	25.2	5	7	(3) 2.50~3.50	41	835313
140/75R17M/C	67W	Battlecruise H50F TL	25.4	5.4	5	(3.5) 3.50~4.25	41	835314
120/70ZR18M/C	59W	Battlecruise H50F TL	24.8	4.7	5	(3.5) 3.50~3.75	42	835315
130/70B18M/C	63H	Battlecruise H50F TL	25.2	5	7	(3.5) 3.00~4.00	41	835316
100/90B19M/C	57H	Battlecruise H50F TL	26.3	3.9	5	(2.5) 2.15~2.75	41	835317
120/70ZR19M/C	60W	Battlecruise H50F TL	25.7	4.8	5	(3.5) 3.00~3.75	41	835319
130/60B19M/C	61H	Battlecruise H50F TL	25.2	5	7	(3.5) 3.00~4.00	41	835320
80/90-21M/C	54H	Battlecruise H50F RFD TL	26.7	3.2	5	(1.85) 1.85~2.15	48	835322
130/60B21M/C	63H	Battlecruise H50F TL	27.1	5	5	(3.5) 3.00~4.00	41	835321
REAR								
140/75R15M/C	65H	Battlecruise H50R	23.3	5.4	8	[3.5] 3.5 ~ 4.25	41	835323
130/90B16M/C	73H	Battlecruise H50R RFD TL	25.2	5.1	9	(3.5) 2.5~3.5	48	835324
140/90B16M/C	77H	Battlecruise H50R RFD TL	26	5.7	9	(3.5) 3.5~3.75	48	835325
150/80B16M/C	77H	Battlecruise H50R RFD TL	25.5	5.9	9	(3.5) 3.0~4.0	48	835326
180/70B16M/C	77H	Battlecruise H50R TL	25.9	7.2	9	(5) 4.25~5.50	41	835329
180/65B16M/C	81H	Battlecruise H50R RFD TL	25.2	7.1	10	(5) 4.25~5.50	48	835328
160/70B17M/C	73V	Battlecruise H50R TL	25.8	6.2	8	(5.0) 4.25~5.0	41	835331
150/60ZR17M/C	66W	Battlecruise H50R TL	24.1	5.8	8	(4) 4.00~4.50	42	835330
180/60B17M/C	75V	Battlecruise H50R TL	25.5	7.2	8	(5) 4.25~5.50	41	835332
200/55R17M/C	78V	Battlecruise H50R TL	25.8	7.7	8	(6.25) 6.00~6.50	41	835333
180/55B18M/C	80H	Battlecruise H50R RFD TL	26.1	7	9	(5.5) 5.00~6.00	42	835334
240/40R18M/C	79V	Battlecruise H50R TL	25.6	9.5	8	(8.5) 8.00~9.00	42	835335

EXEDRA G853 & G852

- OE Fitment on the 2018-2019 Honda GL 1800
- Performance Radial design to offer solid performance and mileage.
- Silica enriched compound offers a high level of grip on both wet and dry surfaces.
- Aramid Mono-Spiral Belt construction (rear) offers high speed stability and shock absorption.

FRONT

REAR



SIZES	LOAD SPEED	TIRE CONSTRUCTION & PATTERN	LETTER CODE	OVERALL DIAMETER	TREAD WIDTH	OTD 32NDS	(MEASURING RIM) APPROVED RIM	MAX P.S.I.	PART #
HONDA									
GL1800 (HONDA APPROVED) 2018-2019 (O.E.)									
130/70R18M/C	63H	G853 RADIAL	G	25.2	5	6	(3.5) 3.5-4.0	41	835247
200/55R16M/C	77H	G852 RADIAL	G	24.6	7.8	10	(6.25) 6-6.5	41	835250

EXEDRA G709 & G704

- Fitment on the 2001-2017 Honda GL 1800.
- Sport Touring Radials designed specifically for the Honda GL1800.
- Offer great performance for GL1800 Gold Wing in various conditions.

FRONT

REAR



SIZES	LOAD SPEED	TIRE CONSTRUCTION & PATTERN	OVERALL DIAMETER	TREAD WIDTH	OTD 32NDS	(MEASURING RIM) APPROVED RIM	MAX P.S.I.	PART #
HONDA								
GL1800 2001-2017								
130/70R18M/C	63H	G709F BW TL	25.3	5.0	6	(3.0) 3.0~4.0	41	835246
180/60R16M/C	74H	G704R BW TL	24.5	6.9	9	(5.0) 4.25~5.5	41	835249

EXEDRA G701 & G702

- Fitment on the 1988-2000 Honda GL 1500.
- Bias-ply touring tires designed for GL1500 Gold Wing.
- Compares to: Dunlop Elite 4/D250, Metzeler ME 888, Avon Cobra.

FRONT

REAR



SIZES	LOAD SPEED	TIRE CONSTRUCTION & PATTERN	OVERALL DIAMETER	TREAD WIDTH	OTD 32NDS	(MEASURING RIM) APPROVED RIM	MAX P.S.I.	PART #
HONDA								
GL1500 1988-2000								
130/70-18M/C	63H	G701F BW TL	25.2	5.0	6	(3.0) 3.0~4.0	41	835245
160/80-16M/C	80H	G702R BW TL	26.0	6.3	9	(3.5) 3.75~4.5	41	835248

METRIC CRUISER RADIALS REPLACEMENT

EXEDRA G851 & G850

- Performance Radials designed for large cruisers, offer solid performance and mileage.
- Silica enriched compound offers a high level of grip on both wet & dry surfaces.
- Aramid Mono-Spiral Belt construction (rear) offers high speed stability and shock absorption.

FRONT

REAR



SIZES	LOAD SPEED	TIRE CONSTRUCTION & PATTERN	OVERALL DIAMETER	TREAD WIDTH	OTD 32NDS	(MEASURING RIM) APPROVED RIM	MAX P.S.I.	PART #
FRONT								
130/70R18M/C	(63W)	G851F BW TL	25.3	5.0	5	(3.5) 3.5~4.0	42	835038
REAR								
180/55ZR18M/C	(74W)	G850R BW TL	25.8	6.9	7	(5.5) 5.5~6.0	42	835043

METRIC CRUISER RADIALS REPLACEMENT

EXEDRA MAX

- Both Bias-Ply and Radial applications. Radials will have an “R” in the size designation.
- Specific rubber compound for cruiser applications designed for long mileage.
- Unique wide shape of tire profile supports touring-type riding while reducing fatigue.
- Belt package construction provides linear handling, even for heavy bikes and 2-up riding.

FRONT

REAR



SIZES	LOAD SPEED	TIRE CONSTRUCTION & PATTERN	OVERALL DIAMETER	TREAD WIDTH	OTD 32NDS	(MEASURING RIM) APPROVED RIM	MAX P.S.I.	PART #
FRONT								
150/80R16M/C	71V	Exedra Max BW TL	25.4	5.9	5	(3.5) 3.0~4.0	41	835252
150/80-16M/C	71H	Exedra Max BW TL	25.4	5.9	5	(3.5) 3.0~4.0	41	835251
120/90-17M/C	64H	Exedra Max BW TL	25.5	4.7	6	(2.75) 2.5~3.0	41	835253
130/70R17M/C	(62W)	Exedra Max BW TL	24.2	5.1	5	(3.5) 3.0~4.0	43	835254
110/90-18M/C	61H	Exedra Max BW TL	25.8	4.3	5	(2.5) 2.15~3.0	41	835255
130/70ZR18M/C	(63W)	Exedra Max BW TL	25.2	5.1	5	(3.5) 3.0~4.0	43	835256
100/90-19M/C	57H	Exedra Max BW TL	26.1	4.0	6	(2.5) 2.15~2.75	41	835257
110/90-19M/C	62H	Exedra Max BW TL	26.8	4.3	5	(2.15) 2.15~3.0	41	835258
90/90-21M/C	54H	Exedra Max BW TL	27.4	3.5	5	(2.15) 1.85~2.15	41	835259
REAR								
140/90-15M/C	70H	Exedra Max BW TL	24.9	5.6	9	(3.5) 2.75~3.75	41	835260
150/90B15M/C	74V	Exedra Max BW TL	25.6	5.9	9	(3.5) 3.0~4.0	43	835261
160/80-15M/C	74S	Exedra Max BW TL	25.1	6.3	9	(3.5) 3.5~4.5	37	835262
170/80B15M/C	77H	Exedra Max BW TL	25.7	6.7	9	(4.0) 3.5~4.5	41	835263
180/70-15M/C	76H	Exedra Max BW TL	24.9	7.1	9	(5.0) 4.25~5.5	41	835264
170/70B16M/C	75H	Exedra Max BW TL	25.4	6.6	9	(5.0) 4.5~5.5	41	835265
180/70R16M/C	77V	Exedra Max BW TL	25.9	7.1	7	(5.0) 5.0~5.5	43	835266
200/60R16M/C	79V	Exedra Max BW TL	25.6	8.1	7	(5.5) 5.5~6.25	43	835267
240/55R16M/C	86V	Exedra Max BW TL	26.4	9.4	9	(8.0) 7.0~8.0	43	835268
170/60ZR17M/C	(72W)	Exedra Max BW TL	25.0	6.6	7	(4.5) 4.5~5.5	43	835269
200/50ZR17M/C	(75W)	Exedra Max BW TL	24.9	7.9	7	(6.25) 6.0~6.5	43	835270
190/60R17M/C	78V	Exedra Max Radial TL	25	8	7	(6.25) 6.0~6.5	43	835588

Upgrading an icon is never easy. The BT46 replaces the BT45 as Bridgestone's premier Bias-Ply vintage sport and touring tire. The BT46 improves wet grip without sacrificing wear life or handling characteristics*.

- TKey Benefits:
- Bias-Ply Tire designed for vintage sport and touring motorcycles
- New Silica single compound in the rear to maximize performance, grip, and wear
- Increased wet performance



SIZES	LOAD SPEED	TIRE CONSTRUCTION & PATTERN	UM CODE	OVERALL DIAMETER	OTD 32NDS	(MEASURING RIM) APPROVED RIM	MAX P.S.I.	PART #
FRONT								
100/90-16 M/C	54H	Battlax BT46F		23.11	6	(2.5) 2.15~2.75	41	835192
110/90-16M/C	59V	Battlax BT46F		23.78	6	2.15-3	41	835193
120/80-16M/C	60V	Battlax BT46F		23.545	5.68	(2.75) 2.75~3.00	41	835194
100/80-17M/C	52H	Battlax BT46F		23.43	5.68	(2.50) 2.50~2.75	41	835195
110/80-17M/C	57H	Battlax BT46F		24.0	6	(2.5) 2.15~2.75	41	835197
110/70-17M/C	54H	Battlax BT46F	UM	23.2	6	(3.0) 2.5~3.5	41	835196
120/70-17M/C	58H	Battlax BT46F		23.8	6	2.75-3.75	41	835198
100/80-18M/C	53H	Battlax BT46F		24.41	5.68	(2.50) 2.50~2.75	41	835199
110/80-18M/C	58V	Battlax BT46F		25	5.68	(2.50) 2.50~3.00	42	835202
110/90-18M/C	61H	Battlax BT46F	UM	25.8	6	(2.5) 2.15~3.0	41	835203
100/90-18M/C	56V	Battlax BT46F		25.1	6	(2.5) 2.15~2.75	41	835200
100/90-18M/C	56H	Battlax BT46F	UM	25.1	6	(2.5) 2.15~3.0	41	835201
90/90-18M/C	51H	Battlax BT46F	UM	24.4	6	(2.15) 1.85~2.5	41	835204
90/90-18M/C	54H	Battlax BT46F	UM	24.4	6	(2.15) 1.85~2.5	41	835578
100/90-19	57H	Battlax BT46F		26.18	6	2.15-2.75	41	835205
3.25-19	54H	Battlax BT46F		26.2	6	(2.15) 1.85~2.5	41	835206
100/90-19M/C	57V	Battlax BT46F		26.18	6	(2.50) 2.15~2.75	41	835207
REAR								
130/90-16M/C	67H	Battlax BT46R		25.1	9	(3.0) 2.5~3.5	41	835208
130/90-16M/C	67V	Battlax BT46R		25.1	9	(3.0) 2.5~3.5	41	835573
150/80-16M/C	71V	Battlax BT46R	UM	25.4	9	(3.5) 3.0~4.0	41	835209
130/90-17M/C	68V	Battlax BT46R	UM	26.1	9	(3.0) 2.5~3.5	41	835214
130/70-17M/C	62H	Battlax BT46R	UM	24.4	9	(3.5) 3.0~4.0	41	835212
140/80-17M/C	69V	Battlax BT46R	UM	25.8	9	(3.5) 2.75~3.75	41	835216
150/70-17M/C	69H	Battlax BT46R	UM	25.2	9	(4.5) 3.5~4.5	41	835217
150/70-17M/C	69V	Battlax BT46R	UM	25.2	9	(4.5) 3.5~4.5	41	835575
130/80-17M/C	65H	Battlax BT46R	UM	24.0	6	(3.0) 2.5~3.5	41	835213
120/80-17M/C	61H	Battlax BT46R	UM	24.6	9	(2.75) 2.5~3.0	41	835210
120/90-17M/C	64V	Battlax BT46R	UM	25.5	9	(2.75) 2.5~3.5	41	835211
130/80-18M/C	66V	Battlax BT46R		25.24	9	2.5-3.5	41	835224
140/70-17M/C	66H	Battlax BT46R	UM	24.7	9	(4.0) 3.5~4.5	41	835215
140/70-18M/C	67H	Battlax BT46R		25.7	9	(4.0) 3.5~4.5	41	835225
120/90-18M/C	65V	Battlax BT46R	UM	26.5	9	(2.75) 2.5~3.0	41	835222
110/80-18M/C	58H	Battlax BT46R	UM	25.2	9	(2.5) 2.15~3.0	41	835219
4.00-18	64H	Battlax BT46R		26.5	9	(2.5) 2.15~3.0	41	835218
110/90-18M/C	61H	Battlax BT46R	UM	25.8	9	(2.5) 2.15~3.0	41	835220
130/70-18M/C	63H	Battlax BT46R		25.4	9	(3.5) 3.0~4.0	41	835223
120/80-18M/C	62H	Battlax BT46R	UM	25.6	9	(2.75) 2.5~3.0	41	835221
150/70-18M/C	70H	Battlax BT46R		26.3	8.65	(4.25) 4.00~4.50	41	835226

BATTLAX SC

Sport-inspired design for the urban rider and commuter with small to medium displacement (<=400cc) scooters. Zip around your city with confidence in both wet and dry conditions.

Key Benefits:

- Sporty handling and stability from V-shape tread pattern
- Designed to reduce noise from optimized main tread groove angle
- Wet weather grip from wider grooves
- Reduces irregular wear and shimmy via optimized tread rigidity



SIZE/AVAILABILITY CHART

FRONT

REAR

SIZES	LOAD SPEED	TIRE CONSTRUCTION & PATTERN	OVERALL DIAMETER	TREAD WIDTH	OTD 32NDS	(MEASURING RIM) APPROVED RIM	MAX P.S.I.	PART #
FRONT								
120/70-12	51S	BATTLAX SC	18.7	4.8	6	3.5	38	835400
110/70-12 M/C	47L	BATTLAX SC	18.2	4.3	7	3	33	835401
110/90-13 M/C	56L	BATTLAX SC	20.9	4.3	6	2.5	33	835403
120/70-13 M/C	53P	BATTLAX SC	19.6	4.8	7	3.5	33	835404
120/80-14 M/C	58S	BATTLAX SC	21.6	4.6	6	2.75	36	835406
100/80-16 M/C	50P	BATTLAX SC	22.3	3.9	6	2.5	33	835409
REAR								
130/70-12	62P	BATTLAX SC	19.3	5.0	8	3.5	41	835414
130/70-12	56L	BATTLAX SC	19.2	5.0	8	3.5	33	835413
120/70-12	51L	BATTLAX SC	18.8	4.8	7	3.5	33	835412
130/70-13 M/C	57P	BATTLAX SC	20.3	5.0	8	3.5	33	835415
150/70-13 M/C	64S	BATTLAX SC	21.4	5.7	10	4	36	835417
140/70-13 M/C	61P	BATTLAX SC	20.7	5.7	9	4	33	835416
90/90-14 M/C	46P	BATTLAX SC	20.6	3.5	8	2.15	33	835422
140/70-14 M/C	68S	BATTLAX SC	21.8	5.5	9	4	45	835421
100/90-14 M/C	57P	BATTLAX SC	21.1	3.9	7	2.5	41	835419



For the maxi-scooter ride who doesn't let a little rain slow them down. Ride confidently and in style on this versatile tread pattern that is derived from the Battlax Sport Touring T31.

- Key Benefits:
- Enhanced precision feeling and handling because of MSB construction*
- Confidence inspiring grip because of 3LC rear construction
- Enhanced grip in wet and cold conditions due to high silica compound*
- Features groove ratio and tread pattern found in BATTLAX Sport Touring T31. Designed to improve water drainage
- Optimized groove angle designed to improve deformation and roll characteristics*

* Comparison based on BATTLAX Scooter SC2 vs. BATTLAX SC from internal testing. Results may vary depending on proper tire and vehicle maintenance, road conditions, and driving habits.



TECHNICAL FEATURES



3LC : Rear tire (160/60R15 M/C)
HTSPC : Rear tire only
MS/BELT : Rear tire only
SILICA RICH EX : Rear tire only

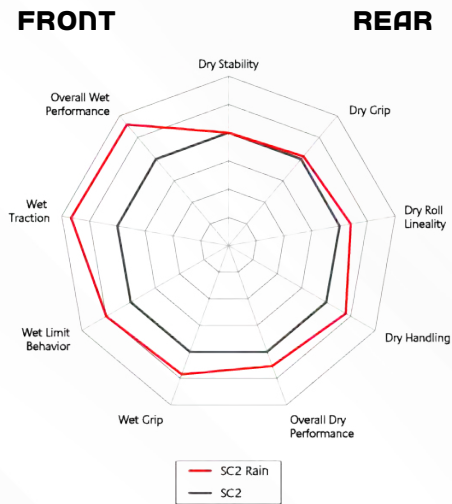

SIZES	LOAD SPEED	TIRE CONSTRUCTION & PATTERN	OVERALL DIAMETER	TREAD WIDTH	OTD 32NDS	(MEASURING RIM) APPROVED RIM	MAX P.S.I.	PART #
FRONT								
120/70R15 M/C	56H	BATTLAX SCOOTER SC2 RAIN	21.7	4.7	5	3.5	41	835428
REAR								
160/60R14 M/C	65H	BATTLAX SCOOTER SC2 RAIN	21.6	6.3	8	4.5	41	835429



BATTLAX SCOOTER SC2

Experience the full potential of your maxi-scooter with the hypersport- inspired Battlax SC2. Whether blasting through the morning commute or discovering your new favorite backroad, the SC2 has you covered.

- Experience the full potential of your maxi-scooter with the hypersport- inspired Battlax SC2. Whether blasting through the morning commute or discovering your new favorite backroad, the SC2 has you covered.
- Key Benefits:
- Enhanced precision feeling and handling because of MSB construction*
- Confidence inspiring grip because of 3LC rear construction
- Enhanced dry cornering grip due to increased block rigidity and featuring
- same tread pattern as BATTLAX Hypersport S21*
- Optimized groove angle designed to improve deformation and roll characteristics*

*Comparison based on BATTLAX Scooter SC2 vs. BATTLAX SC from internal testing. Results may vary depending on proper tire and vehicle maintenance, road conditions, and driving habits.



FRONT

REAR

TECHNICAL FEATURES



New Pattern

- Made to perform while still retaining the modern classic style

Touring Compound

- Reliable wet and dry performance by utilizing the latest touring compounds

3LC™ Tread For Rear

SIZES	LOAD SPEED	TIRE CONSTRUCTION & PATTERN	OVERALL DIAMETER	TREAD WIDTH	OTD 32NDS	(MEASURING RIM) APPROVED RIM	MAX P.S.I.	PART #
FRONT								
120/70R14 M/C	55H	BATTLAX SCOOTER SC2	20.8	4.7	5	3.5	41	835424
120/70R15 M/C	56H	BATTLAX SCOOTER SC2	21.7	4.7	5	3.5	41	835425
REAR								
160/60R14 M/C	65H	BATTLAX SCOOTER SC2	21.6	6.3	8	4.5	41	835426
160/60R15 M/C	67H	BATTLAX SCOOTER SC2	22.6	6.4	8	4.5	41	835427



CONQUER THE CITY

For riders who want safe, durable and reliable tyres when navigating the urban jungle.

All-round, street-use scooter tyres, intended for young, sporty city users. With an extensive size line up, Hoop B01 is one of the most popular Bridgestone scooter tyres. Designed for a long life and with a full size line-up covering a large range of scooters. High gripping power and wet-weather performance will let you enjoy some slick riding. Tubeless (TL). Blackwall. J-rated for speeds up to 100 km/h (62 mph).

HOOP B01 FEATURES

Discover the features of your Bridgestone tyres:

SAFE AND FUN ON THE STREETS

High gripping power and wet-weather performance will let you enjoy some slick riding.

**HOOP
B01**



SIZES	LOAD SPEED	TIRE CONSTRUCTION & PATTERN	OVERALL DIAMETER	TREAD WIDTH	(MEASURING RIM) APPROVED RIM	PART #
FRONT/ REAR						
2.75-10	26J	HOOP B01 B01	15.6	2.7	1.5	835336
3.50-10	59J	HOOP B01 B01	17	3.6	2.50	835337
80/90-10	44J	HOOP B01 B01	15.6	3	2.15	835338
3.00-8	26J	HOOP B01 B01	14	3	2.15	835339



HOOP B02

BRIDGESTONE HOOP B02 PRO

Own the City! Get the grip you need to navigate the urban jungle safely, comfortably and efficiently.

High-quality replacement tires. Tube type (TT) or tubeless (TL). Blackwall Æ J-rated for speeds up to 100 km/h (62 mph), L-rated for speeds up to 120 km/h (75 mph), P-rated for speeds up to 150 km/h (94 mph), S-rated for speeds up to 180 km/h (112 mph) and H-rated for speeds up to 210 km/h (130 mph).

HOOP B02 PRO FEATURES

Discover the features of your Bridgestone tyres:

WHATEVER THE CONDITIONS

Designed to meet the challenges of city riding on a variety of surfaces, in the wet and in the dry.

HOOP B02



SIZES	LOAD SPEED	TIRE CONSTRUCTION & PATTERN	OVERALL DIAMETER	TREAD WIDTH	(MEASURING RIM) APPROVED RIM	PART #
REAR						
150/70-13M/C	64S	B02	21	5.5	4	835342

HOOP B03

The Bridgestone 120/80-14 M/C HOOP B03F is the front tire that Suzuki chose for the OEM rubber on their 2006 and later Burgman 400 scooters. This is still the size used on current production (2010) scooters.

The Bridgestone B03 tread pattern is a popular street-style tread that is as good on the highway as it is in urban stop-&-go traffic.

HOOP B03



SIZES	LOAD SPEED	TIRE CONSTRUCTION & PATTERN	OVERALL DIAMETER	TREAD WIDTH	(MEASURING RIM) APPROVED RIM	PART #
FRONT						
120/80-14M/C	58S	B03	21	4.2	3.50	835341

BATTLAX BT 54 RADIAL



SPORTS

- Single crown radius profile and radial construction provide stable and neutral steering characteristics
- Balanced, long-life cruiser tire - perfect for riders who enjoy long tours on large machines
- High-performance radial street bike tire with excellent balance for touring
- Specifically designed for big bikes
- Designed to disperse water efficiently on shallow banking corners, crucial in wet conditions



SIZES	LOAD SPEED	TIRE CONSTRUCTION & PATTERN	OVERALL DIAMETER	TREAD WIDTH	OTD 32NDS	(MEASURING RIM) APPROVED RIM	MAX P.S.I.	PART #
FRONT								
110/80ZR18M/C	58V	BT54 RADIAL	-	-	-	-	-	835227
REAR								
140/70R18M/C	67V	BT54 RADIAL	-	-	-	-	-	835228

BATTLAX TH01

The Bridgestone Battlax TH01 scooter tires are specially designed for large engine capacity scooters. Battlax TH01 provides good handling and cruising. The Bridgestone Battlax TH01 scooter tires are specially designed for large engine capacity scooters. Battlax TH01 provides good handling and cruising.

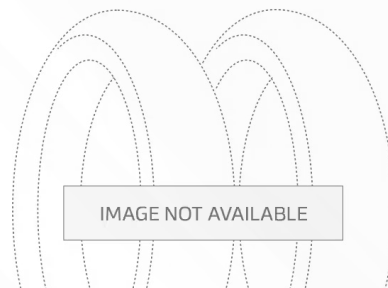

SIZES	LOAD SPEED	TIRE CONSTRUCTION & PATTERN	OVERALL DIAMETER	TREAD WIDTH	OTD 32NDS	(MEASURING RIM) APPROVED RIM	MAX P.S.I.	PART #
FRONT								
120/70R15M/C	56H	TH01 RADIAL	-	5	-	-	-	835465
REAR								
160/60R14M/C	65H	TH01 RADIAL	-	8	-	-	-	835466

BATTLAX BT011 & BT012

The BT011 & BT012 F-E Scooter Tire is a premium, radial scooter tire, and the OE tire of choice for select scooter manufacturers.

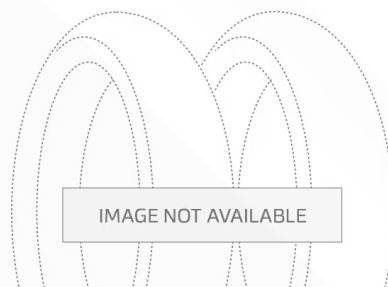

SIZES	LOAD SPEED	TIRE CONSTRUCTION & PATTERN	OVERALL DIAMETER	TREAD WIDTH	OTD 32NDS	(MEASURING RIM) APPROVED RIM	MAX P.S.I.	PART #
FRONT								
120/70R15M/C	56H	BT011 RADIAL	-	-	-	-	-	835159
REAR								
160/60R15M/C	67H	BT012 RADIAL	-	-	-	-	-	835160

FAST SAME DAY SHIPPING

BATTLAX BT-020

Bridgestone Battlax BT-020 Sport Touring Tires

The Battlax BT020 from Bridgestone is designed for sport-touring riders looking for riding comfort, tire life and tire design. As one of the best selling sport-touring tires worldwide, Battlax BT-020 offers high-speed stability, long mileage, wet performance, riding comfort and consistent performance. OE tire on many touring bikes and cruisers.

- Features:
- Bias and radial versions available
- Tubeless design
- "M" spec is OE equipment for BMW K1200LT 2005-10
- OE tire Kawasaki VN2000 2004-10

FRONT **REAR**



SIZES	LOAD SPEED	TIRE CONSTRUCTION & PATTERN	OVERALL DIAMETER	TREAD WIDTH	OTD 32NDS	(MEASURING RIM) APPROVED RIM	MAX P.S.I.	PART #
REAR								
200/60R16M/C	79V	BT020R RADIAL	25.43	8	-	-	-	835167
160/70B17M/C	79V	BT020R - M RFD	25.83	8	-	-	-	835169
170/60ZR17M/C	72W	BT020R RADIAL F	-	9	-	-	-	835170

BATTLAX BT023

The BT023 is Bridgestone's budget Sports Touring tyre, it was introduced as the replacement for the incredibly popular BT021. This one offers great mileage and wet weather performance at a great price.



SIZES	LOAD SPEED	TIRE CONSTRUCTION & PATTERN	OVERALL DIAMETER	TREAD WIDTH	OTD 32NDS	(MEASURING RIM) APPROVED RIM	MAX P.S.I.	PART #
FRONT								
120/70ZR17M/C	58W	BATTLAX BT023F - F	24	-	-	(3.5) 3.00~3.50	5	835173
REAR								
180/55ZR17M/C	73W	BATTLAX BT023F - F	25	-	-	(5.50) 5.50~6.00	7	835176

BATTLAX BT028

Bridgestone Battlax BT-028 Tires

Sport Touring and Cruiser Radials designed for touring oriented sport riders offering solid performance and good mileage.



SIZES	LOAD SPEED	TIRE CONSTRUCTION & PATTERN	OVERALL DIAMETER	TREAD WIDTH	OTD 32NDS	(MEASURING RIM) APPROVED RIM	MAX P.S.I.	PART #
FRONT								
120/70R18M/C	59V	BATTLAX BT028F RADIAL G	24.61	5	-	-	5	835177
REAR								
200/50R18M/C	76V	BATTLAX BT028F RADIAL G	25.87	7	-	-	7	835178

ML16

BRIDGESTONE

SPORTS

REAR



The Bridgestone ML16 4.00-10 (60J) is a high-quality, bias-belted, tubeless rear scooter tire celebrated for its reliable wet grip, OEM-level construction, and paired designed with the ML17 front tire. Available locally and via import—choose based on availability and delivery priorities.

SIZES	LOAD SPEED	TIRE CONSTRUCTION & PATTERN	PART #
REAR			
4.00-10	60J	ML16	835366
120/90-10	66J	ML16	835365

ML17

FRONT



The Bridgestone ML17A 110/100-12 (67J) is a high-quality OEM-grade front scooter tire. It offers excellent wet traction, durability, and a matched ride feel when paired with the ML16 rear. Ideal for Honda Helix/Fusion and similar scooters with 12" wheels, it delivers dependable performance for daily commuting and light touring.

SIZES	LOAD SPEED	TIRE CONSTRUCTION & PATTERN	PART #
FRONT			
110/100-12	67J	ML17	835367

MAG.MOPUS L303/L309

FRONT



The Bridgestone MAG MOPUS L303F 3.00-18 (47P) is a reliable OEM-style front tire made for smaller cruising motorcycles. With a bias-ply tube setup, balanced wet/dry traction, and modest load/speed rating, it's well-suited for everyday street riding—not high-speed or off-road use. OEM fitment and consistent build quality make it a solid choice if your bike originally used L303-series tires.

SIZES	LOAD SPEED	TIRE CONSTRUCTION & PATTERN	PART #
FRONT			
3.00-18	47P	MAG.MOPUS L303	835343
140/80-17M/C	69H	MAG.MOPUS L309F	835344

MAG.MOPUS G548R

FRONT



The Bridgestone G548R MAG MOPUS 160/70-17 (73V) is a premium rear tire for cruiser touring. With its balance of tread compound, belt stability, and comfort-focused profile, it's ideal for riders seeking durability, smooth handling, and confidence across weather conditions.

SIZES	LOAD SPEED	TIRE CONSTRUCTION & PATTERN	PART #
FRONT			
160/70-17M/C	73V	MAG.MOPUS G548R	835306

FAST SAME DAY SHIPPING

SAFETY WARNING

Run-In

Use care when riding on new tires. We recommend that you ride slowly and carefully for the first 60 miles (~100 km) until you become accustomed to the performance of your new tires in conjunction with your motorcycle. We recommend avoiding extreme maneuvers, including sudden acceleration, maximum braking and hard cornering, until you have become accustomed to the performance of your tires in conjunction with your motorcycle.

MOTORCYCLE STREET TIRE SIZE

FRONT

Metric	Alpha	Inch
80/90	MH90	2.50/2.75
90/90	MJ90	2.75/3.00
100/90	MM90	3.25/3.50
110/90	MM90	3.75/4.00
120/80	-	4.25/4.50
120/80	MR90	4.25/4.50
130/80	MT90	5.00/5.10

REAR

Metric	Alpha	Inch
110/90	MN90	3.75/4.25
120/80	MP85	4.50/4.75
120/90	MP85	4.50/4.75
130/80	-	5.00/5.10
130/90	MT90	5.00/5.10
140/80	-	5.50/6.00
140/90	MU90	5.50/6.00
150/80	MV85	6.00/6.25
150/90	MV85	6.00/6.25

MOTORCYCLE KNOBBY TIRE SIZE

FRONT

Metric	Alpha	Inch
70/100	80/90	2.75/3.00
80/100	90/90	3.00/3.25
90/100	90/100	3.25

REAR

Metric	Alpha	Inch
90/100	100/80	3.60/4.10
100/90	110/80	4.10/4.60
110/90	120/80	4.50/5.10
110/100	130/80	5.10

LOAD INDEX RATING

LI	lbs	LI	lbs	LI	lbs	LI	lbs	LI	lbs
22	187	35	267	48	397	61	567	74	827
23	193	36	276	49	408	62	584	75	853
24	198	37	282	50	419	63	600	76	882
25	204	38	291	51	430	64	617	77	908
26	209	39	300	52	441	65	639	78	937
27	215	40	309	53	454	66	661	79	963
28	220	41	320	54	467	67	677	80	992
29	227	42	331	55	481	68	694	81	1019
30	234	43	342	56	494	69	716	82	1047
31	240	44	353	57	507	70	736	83	1074
32	247	45	364	58	520	71	761	84	1102
33	254	46	375	59	536	72	783	85	1135
34	260	47	386	60	551	73	805	86	1168

STREET TIRE SIZE DESIGNATIONS

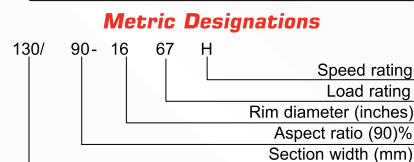
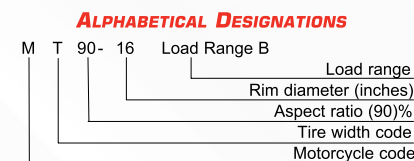
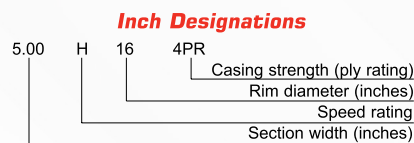

Load Rating - A numerical code which corresponds to the total load carrying capacity at the speed indicated by the speed symbol.

$$\text{Aspect Ratio} = \frac{\text{Section height}}{\text{Section width}} \times 100$$

SPEED RATING

Motorcycle use		MAXIMUM DESIGN/TEST SPEED	
		(Mph)	(km/h)
	F TYPE	50	80
	J TYPE	62	100
	L TYPE	75	120
	M TYPE	81	130
	N TYPE	87	140
	P TYPE	94	150
	Q TYPE	99	160
	R TYPE	106	170
	S TYPE	112	180
	H TYPE	130	210
	V TYPE	149	240
	Z TYPE	149+	240+
	W TYPE	168	270
FLOTATION TYPE (Low I.P.)	(W) TYPE	168+	270+
		50	80

Warning: Only Properly trained personal should mount tires.



TIRES & TRACKS

TUBES

CHEMICALS

TOOLS

BATTERIES

FUEL & INTAKE

AIR & OIL FILTERS

FAST SAME DAY SHIPPING

Continental

The Future in Motion

ZeroDegree

0° steel-belted construction guarantees excellent stability at high speeds.



TractionSkin

TractionSkin, a revolutionary new micro-rough tread surface, virtually puts an end to tire breakin.

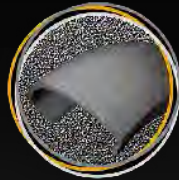

RainGrip

New „Wet Grip“ compound for superior wet grip and higher mileage.

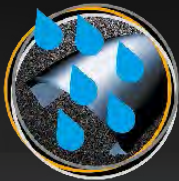

MultiGrip

Makes it possible to use a homogenous grip grading with a single compound.



HYPERSPORT TIRES

ContiSport *ATTACK*

Supersports street tire for the price conscious rider

- 0° steel-belt construction, front and rear, guarantees excellent stability at high speeds.
- Good control when braking for corners.
- Well defined and wide breakaway characteristics at maximum lean angle.
- Cutting-edge design for the tread pattern, perfect for modern sports bikes.



DIMENSIONS	F/R	PATTERN	MFG #	PART #
120/70ZR17 M/C (58W) TL	F	ContiSportAttack	02443990000	836108
180/55ZR17 M/C (73 W) TL	R	ContiSportAttack	02443930000	836109
190/50ZR17 M/C (73 W) TL	R	ContiSportAttack	02444000000	836110
190/55ZR17 M/C (75 W) TL	R	ContiSportAttack	02443950000	836111

SPORT/HYPERSPORT TIRES

ContiSport *ATTACK 4*

Maximum grip with Black Chili Performance, accuracy and easy handling for the most powerful superbikes

- More grip and improved traction thanks to the latest compound technology
- Larger footprint at extreme cornering angles
- Typical Conti agility and precision when turning
- Rapid warm-up for confidence from the first kilometers
- RainGrip technology of the Continental test winners
- Also suitable for hobby race track use (without tire warmers)



DIMENSIONS	F/R	PATTERN	MFG #	PART #
120/70 ZR 17	F	ContiSportAttack 4	02445980000	836444
120/70 ZR 17	F	ContiSportAttack 4C	02446840000	836445
160/60 ZR 17	R	ContiSportAttack 4	02446040000	836446
180/55 ZR 17	R	ContiSportAttack 4	02446030000	836447
190/50 ZR 17	R	ContiSportAttack 4	02446020000	836448
190/50 ZR 17	R	ContiSportAttack 4C	02446850000	836449
190/55 ZR 17	R	ContiSportAttack 4	02446000000	836450
200/55 ZR 17	R	ContiSportAttack 4	02445990000	836452



ContiAttack SM 2

The New ContiAttack SM 2: Strong Mileage and Performance for Road and Race Track

- New track-proven high-performance tire for the ultimate supermoto riding experience
- The road-legal supermoto tire follows ContiAttack SM EVO
- Faster lap times – up to 28 percent longer mileage[1] with more tread depth

DIMENSIONS	F/R	PATTERN	MFG #	PART #
110/70R17	F	ContiAttack SM 2	02447730000	836494
120/70R17	F	ContiAttack SM 2	02447740000	836495
140/70R17	R	ContiAttack SM 2	02447750000	836496
150/60R17	R	ContiAttack SM 2	02447760000	836497
160/60R17	R	ContiAttack SM 2	02447770000	836498

ContiRoadAttack 4

The Hyper-Touring tire

- All-new compound and updated tread pattern gives a massive boost to wet weather performance.
- Faster warm-up in cold and wet conditions for instant trust and safety.
- Easy, intuitive handling characteristics for the newest machines and as an upgrade for older bikes.
- Superb grip in all conditions and even better dry grip that rivals pure sport tires.
- New 'slick' area on the upper tread shoulder, for class-topping cornering grip at high lean angles.



DIMENSIONS	F/R	PATTERN	MFG #	PART #
110/80R 19	F	ContiRoadAttack 4	02447080000	836481
120/70ZR 17	F	ContiRoadAttack 4	02447050000	836475
120/70ZR 17	F	ContiRoadAttack 4	02447100000	836480
120/70ZR 19	F	ContiRoadAttack 4	02447090000	836482
150/70R 17	R	ContiRoadAttack 4	02447110000	836483
160/60ZR 17	R	ContiRoadAttack 4	02447120000	836476
170/60ZR 17	R	ContiRoadAttack 4	02447130000	836484
180/55ZR 17	R	ContiRoadAttack 4	02447140000	836477
180/55ZR 17	R	ContiRoadAttack 4	02447170000	836485
190/50ZR 17	R	ContiRoadAttack 4	02447150000	836478
190/50ZR 17	R	ContiRoadAttack 4	02447190000	836486
190/55ZR 17	R	ContiRoadAttack 4	02447160000	836479
190/55ZR 17	R	ContiRoadAttack 4	02447180000	836487



ContiRoad

German engineered Sport Touring Tire for the demanding rider

- Highest Continental quality standards - newly developed tire from the test winning Korbach engineering team
- Newly developed tire for comfortable touring and agile handling on country roads
- Modern tread compound, inspired by the test winning ContiRoadAttack 3 technology
- High mileage thanks to non-tangent profile grooves at the central tread of the rear tire
- A new silica-technology guarantees a high micro-interlocking with the asphalt
- Tread design with an extra-large positive proportion for a higher mechanical grip

DIMENSIONS	F/R	PATTERN	MFG #	PART #
110/70 R 17	F	ContiRoad	02445870000	836453
120/70 ZR 17	F	ContiRoad	02445860000	836454
150/60 R 17	R	ContiRoad	02445900000	836456
180/55 ZR 17	R	ContiRoad	02445880000	836459
190/50 ZR 17	R	ContiRoad	02445930000	836460
190/55 ZR 17	R	ContiRoad	02445940000	836461



ContiMOTION

Sport touring radial tire for the price conscious rider

- Brand new concept radial tire for the entry level market.
- Safe and reliable feedback on both dry and wet roads.
- Value for money mileage due to new formulated polymers in the compound.
- 0° steel-belt construction on the rear for excellent stability and ride comfort.

DIMENSIONS	F/R	PATTERN	MFG #	PART #
110/70ZR17 M/C 54W TL	F	ContiMotion Z	02446480000	836158
120/70ZR 17 M/C (58W) TL	F	ContiMotion Z	02550190000	836016
140/70ZR17 M/C 66W TL	R	ContiMotion M	02441610000	836160
150/70ZR17 M/C 69W TL	R	ContiMotion M	02441570000	836162
160/60ZR17 M/C (69W) TL	R	ContiMotion M	02441580000	836018
170/60ZR17 M/C (72W) TL	R	ContiMotion M	02441560000	836163
180/55ZR 17 M/C (73W) TL	R	ContiMotion M	02550200000	836020
190/50ZR 17 M/C (73W) TL	R	ContiMotion M	02550220000	836021
200/50ZR17 M/C 75W TL	R	ContiMotion M	02550300000	838213

STREET TIRES



CONTI ATTACK SM EVO

- The tire “CONTI ATTACK SM EVO - 110/70 R 17 MC 54H TL” is a Continental ContiAttack SM EVO motorcycle tire, specifically a front tire with the size 110/70 R17. It is a tubeless (TL) tire with a load index of 54 and a speed rating of H. The “MC” indicates it’s designed for motorcycles.

DIMENSIONS	F/R	PATTERN	MFG #	PART #
110/70 R 17	R	CONTI ATTACK SM EVO	02445720000	836277

ContiRaceAttack 2 Street



- Our race track tire - also for your favourite road rides.
- For maximum grip on road and race track surfaces.
- Minimal negative tread, no grooves on shoulder to allow maximum grip at lean angles.
- Maximum predictability at the limit due to special carcass construction and tread compound (GripLimitFeedback technology).
- Tested with low air pressure for race track use; also suitable with tire warmers. For even greater performance on the race track, the ContiRaceAttack 2 Street may be combined with the ContiRaceAttack 2 soft / medium.
- Original equipment on BMW M 1000 XR.

DIMENSIONS	F/R	PATTERN	MFG #	PART #
120/70 ZR 17	F	RACE ATTACK 2 STREET	02446580000	836438
180/55 ZR 17	R	RACE ATTACK 2 STREET	02446590000	836439
190/55 ZR 17	R	RACE ATTACK 2 STREET	02446610000	836441
200/55 ZR 17	R	RACE ATTACK 2 STREET	02446620000	836442

Conti Trail Attack 3

Our adventure tire developed for the road. 100% confidence right from the start for modern and powerful adventure tourers.



- Shortest warm-up time. Optimal temperature reached within the first 1500 meters (internal outdoor wear test under realistic touring conditions on BMW 1200 GS (K50)).
- After 3500 km there is more tread depth than the benchmark competitor tire and still has better handling abilities (internal outdoor wear test under realistic touring conditions on BMW 1200 GS (K25)).
- Built to ensure the highest constant level of performance even after thousands of kilometers due to a mix of MultiGrip, carcass construction and pattern design.
- Outstanding wet grip achieved by compound and pattern design.
- Extremely agile all-rounder for easy, accurate and predictable handling.
- High level of comfort, absorption and stability even on challenging road conditions

DIMENSIONS	F/R	PATTERN	MFG #	PART #
110/80 R 19	F	CONTI TRAIL ATTACK 3	0244531	836168
120/70 R 19	F	CONTI TRAIL ATTACK 3	0244532	836169
120/70 ZR 17	F	CONTI TRAIL ATTACK 3	0244537	836170
120/70 ZR 19	F	CONTI TRAIL ATTACK 3	0244535	836171
130/80 R 17	R	CONTI TRAIL ATTACK 3	0244538	836175
140/80 R 17	R	CONTI TRAIL ATTACK 3	0244539	836176
150/70 R 17	R	CONTI TRAIL ATTACK 3	0244533	836178
150/70 ZR 18	R	CONTI TRAIL ATTACK 3	0244543	836179
160/60 ZR 17	R	CONTI TRAIL ATTACK 3	0244540	836180
170/60 R 17	R	CONTI TRAIL ATTACK 3	0244534	836181
170/60 ZR 17	R	CONTI TRAIL ATTACK 3	0244536	836182
180/55 ZR 17	R	CONTI TRAIL ATTACK 3	0244541	836183
190/55 ZR 17	R	CONTI TRAIL ATTACK 3	0244542	836184

TKC 70

The perfect on- and off-road adventure tire.



- Trail tire designed for off-road use and a speed index up to 240 km/h.
- The TKC 70 is designed for light to medium off-road use with extraordinary street performance.
- Uniquely constructed tread block pattern makes the TKC 70 quiet and stable on the road while still providing good off-road capability.
- Agile on streets and safe on gravel roads.

DIMENSIONS	F/R	PATTERN	MFG #	PART #
120/70 ZR 17	F	TKC 70	0244463	836209
110/80 R 18	F	TKC 70	0244469	836210
110/80 R 19	F	TKC 70	0244383	836212
120/70 R 19	F	TKC 70	0244382	836213
140/80 R 17	R	TKC 70	0244637	836220
150/70 R 17	R	TKC 70	0244385	836221
160/60 ZR 17	R	TKC 70	0244464	836222
170/60 R 17	R	TKC 70	0244384	836223
180/55 ZR 17	R	TKC 70	0244465	836224
150/70 R 18	R	TKC 70	0244579	836227



TKC 70 ROCKS

The off-road evolution of the TKC 70 to a more aggressive adventure tire

- For the first time, a standard TKC 70 front tire can be combined with a more aggressive off-road oriented TKC 70 Rocks rear tire profile
- More traction off-road with the usual excellent road performance of a TKC 70
- A pleasantly quiet tire thanks to an enhanced lug arrangement to suppress noise
- Korbach radial tires for the adventure travel rider

DIMENSIONS	F/R	PATTERN	MFG #	PART #
130/80 R 17	R	TKC 70Rocks	02446490000	836462
140/80 R 17	R	TKC 70Rocks	02446380000	836463
150/70 R 17	R	TKC 70Rocks	02446390000	836464
170/60 R 17	R	TKC 70Rocks	02446430000	836465
150/70 R 18	R	TKC 70Rocks	02446450000	836466

TKC 80 Twinduro

Well-ried multi-use tire for both street and dirt

- Proven and tested for adventure trips and competition.
- Self-cleaning tread pattern and High level of side stability on soft surfaces.
- Very good on-road handling and mileage.
- Original equipment BMW R 1200 GS Adventure, F 800 GS Adventure, KTM 1090 Adventure R and Husqvarna 701 Enduro.



DIMENSIONS	F/R	PATTERN	MFG #	PART #
120/70-19	F	TKC80	02405660000	836488
90/90-21	F	TKC80	02405670000	836489
120/90-18	R	TKC80	02405710000	836491
140/80-18	R	TKC80	02405720000	836492
150/70B18	R	TKC80	02405730000	836493
170/60B17	R	TKC80	02405700000	836490



Conti Classic Attack

- Exceptionally easy handling with ultra high grip and cornering stability.
- Superb control and optimal feedback.
- Excellent grip in all conditions, even in the wet and at low temperatures.
- Force directional tread pattern for optimal wear behavior and excellent water displacement.
- Optimized radial carcass design for good handling and high stability.

DIMENSIONS	F/R	PATTERN	MFG #	PART #
120/90R18 M/C	F	ContiClassicAttack	02443020000	836275



K **KENDA**
TIRES



WHERE
STRENGTH
MEETS
STEALTH

KM1 | KM001



Kenda proudly announces the release of its new KM1 sport touring radial. Kenda's engineering team took great care in balancing the critical elements of sport touring tires: grip and longevity while maintaining the quality and affordability that has become synonymous with the Kenda brand.

- State-of-the-art construction and advanced rubber compound technology combine to create Kenda's first sport-touring radial
- Optimized apex geometry delivers perfect balance of high-speed stability and lightning fast turn-in
- Proprietary compound reaches target operating temperature faster than competitor

SIZES	LOAD SPEED/INDEX	TT/TL	PART #
FRONT			
120/70ZR17	58W	TL	250611
REAR			
160/60ZR17	69W	TL	250614
180/55ZR17	73W	TL	250610
190/50ZR17	73W	TL	250609

CATACLYSM - K6702

CATACLYSM | K6702



Looking for new high-end cruiser tire for your upcoming adventures? We recommend the Cataclysm motorcycle tires with dual-compound technology. And here's why: the Cataclysm provides higher mileage in the center and increased grip on the edges for optimal stability in cornering.

- Dual-compound technology for improved mileage in center and added grip on the shoulder
- Tread grooving designed to efficiently disperse water while minimizing uneven wear

SIZES	LOAD SPEED/INDEX	TT/TL	PART #
FRONT			
130/90B16	67H	TL	250486
130/80B17	65H	TL	250491
130/70B18	63H	TL	250493
130/60B19	61H	TL	250580
130/60B21	63H	TL	250604
100/90B19	57H	TL	250494
80/90-21	54H	TL	250495
90/90-21	54H	TL	250496
REAR			
170/80B15	77H	TL	250485
130/90B16	73H	TL	250487
140/90B16	77H	TL	250488
150/80B16	77H	TL	250489
180/65B16	81H	TL	250490
160/70B17	79H	TL	250492
180/55B18	80H	TL	250648

KRUZ - K673

KRUZ | K673

The new Kenda Kruz was designed specifically for today's larger bikes. A great all weather tire for tons of applications.

- New bias/belted casing design for improved handling and high load carrying capacity
- New rubber compound for improved mileage
- Front and rear tread patterns designed for all weather riding



SIZES	LOAD SPEED/INDEX	TT/TL	TREAD DEPTH (MM)	PART #
FRONT				
140/80H-17F	69H	TL	5.00	250448
130/90H-16F	72H	TL	4.00	250039
150/80H-16F	71H	TL	7.00	250042
120/90H-17F	64H	TL	5.00	250045
110/90H-18F	61H	TL	5.00	250046
120/90H-18F	71H	TL	5.00	250047
130/70H-18F	63H	TL	5.00	250048
100/90H-19F	57H	TL	5.00	250049
110/90H-19F	62H	TL	5.00	250050
80/90H-21F	48H	TL	3.00	250051
REAR				
140/90H-15	70H	TL	7.00	250036
150/90H-15	74H	TL	8.00	250037
170/80H-15	77H	TL	8.00	250038
130/90H-16	74H	TL	7.00	250040
140/90H-16	77H	TL	9.00	250041
150/80H-16	71H	TL	7.00	250043
160/80H-16	75H	TL	9.00	250044

RETROACTIVE - K676 / K676F

RETROACTIVE | K676 / K676F

If you're looking for new shoes for an old classic, the RetroActive is for you!

- V-rated bias tire for the classic 70's and 80's sportbikes
- Tread pattern designed for all-weather riding
- New compound for improved durability/mileage



SIZES	LOAD SPEED/INDEX	TT/TL	TREAD DEPTH (MM)	PART #
FRONT				
110/70B-17 F	54V	TL	3.50	250526
REAR				
120/90B-18 R	65V	TL	6.50	250430
130/80B-18 R	66V	TL	6.50	250431
150/70B-17 R	69V	TL	6.50	250428

CHALLENGER | K657

The Challenger has stood the test of time as a great value in the touring segment.

- Excellent choice for lightweight sport touring vehicles
- H-rated, tubeless construction
- NOT for high load carrying capacity motorcycles



SIZES	LOAD SPEED/INDEX	TT/TL	TREAD DEPTH (MM)	PART #
FRONT				
130/90H-16	74H	TL	6.5	250054
100/90H-18	56H	TL	4.5	250059
100/90H-19	57H	TL	4.5	250063
110/90H-19	68H	TL	4.5	250064
90/100H-21	56H	TL	4.5	250065
REAR				
130/90H-15	66H	TL	6.5	250052
140/90H-15	70H	TL	7.2	250053
120/90H-16	63H	TL	6.5	250055
130/90H-16	74H	TL	6.5	250056
140/90H-16	77H	TL	7.2	250057
130/90H-17	68H	TL	6.5	250058
110/90H-18	61H	TL	6.5	250060
120/90H-18	65H	TL	6.5	250061
130/90H-18	69H	TL	6.5	250062

KANINE - KR20

KANINE | KR20

The first and only aftermarket tire designed specifically for 3 wheeled auto cycles.

- Greater mileage than stock, better handling than passenger car replacements.
- High-performance pattern reduces rolling resistance while keeping maximum lateral traction.
- Engineered with increased siping to evacuate standing water for excellent wet weather performance.
- MC-spec, DOT, and E-Mark approved.



SIZES	LOAD SPEED/INDEX	TT/TL	PART #
FRONT			
165/55R15	69H	TL	250568
K145/60R16	66T	TL	250626
REAR			
225R50R15	84H	TL	250569
K205/45R16	81T	TL	250625
K205/55R15	77T	TL	250624

SCOOTER - 433 & 434



SCOOTER | 433 & 434

- Performance style tread pattern
- Sport-oriented riding tire
- Compound designed for long wear and mileage
- Available in 14 popular sizes

SIZES	LOAD SPEED/INDEX	TT/TL	TREAD DEPTH (MM)	PART #
FRONT				
110/80-12	65J	TL	4.5	250352



SCOOTER | K453

- Performance style tread pattern
- Sport-oriented riding tire
- Compound designed for long wear and mileage
- Available in 14 popular sizes

SIZES	LOAD SPEED/INDEX	TT/TL	TREAD DEPTH (MM)	PART #
FRONT/REAR				
350-10	51L	TL	5.30	250359

SCOOTER-K761

SCOOTER | K761



Leaning more towards street riding than trail riding? The K761 Dual Sport is the tire for you.

- 30% dirt / 70% road
- Chunky, aggressive design for street-oriented dual-sports
- Original equipment tires on models from several major manufacturers
- Gravel and fire road performance while maintaining excellent street manners
- Long tread life for one of the best value motorcycle tires on the market
- Available in 29 popular sizes for fitment on multiple motorcycle categories

SIZES	LOAD SPEED/INDEX	TT/TL	TREAD DEPTH (MM)	PART #
FRONT / REAR				
120/90-10	57J	TL	5.5	250367
130/90-10	61J	TL	5.5	250368
110/90-12	64J	TL	5.5	250370
120/70-12	51J	TL	5.5	250371
130/70-12	56J	TL	5.5	250373
130/80-12	69J	TL	5.5	250374
130/90-16 R	73H	TL	9	250561
130/90-16 F	73H	TL	7	250562
130/80-17 R	65H	TL	9.5	250564
140/60-13	57J	TL	6	250377

SCOOTER | K329

- Performance style tread pattern
- Balanced design for both mileage and wet weather traction
- Available in 5 popular sizes

SIZES	LOAD SPEED INDEX	TT/TL	TREAD DEPTH(MM)	PART #
FRONT / REAR				
250-10 TT	33J	TT	3.50	250329
275-10 TT	37J	TT	3.50	250330
350-10 TT/TL	51J	TL	5.50	250331
90/90-10	50J	TL	5.50	250332
120/90-10 TL	56J	TL	5.00	250333

SCOOTER - K413

SCOOTER | K413

- Race-inspired tread pattern
- Designed for performance-minded machines
- Specially grooved to displace water on road
- Available in 10 popular sizes

SIZES	LOAD SPEED/INDEX	TT/TL	TREAD DEPTH (MM)	PART #
FRONT / REAR				
300-10	42J	TL	4.5	250335
350-10	51J	TL	4.5	250336
90/90-10	50J	TL	5	250337
120/90-10	57J	TL	4.5	250341
130/90-10	61J	TL	4.5	250343
120/70-12	51J	TL	5	250345
130/70-12	56J	TL	4.5	250346
140/70-12	60J	TL	4.5	250347
120/70-13	53M	TL	4.5	250348
130/60-13	53J	TL	4.5	250349
140/60-13	57J	TL	6.00	250350

CRUISER - K671

CRUISER | K671



The Cruiser is a great match for any smaller sport-touring bike.

- Excellent choice for lightweight sport vehicles
- Deep offset tread grooves for all weather riding
- Tubeless construction
- DOT approved/H-rated
- NOT recommended for high load carrying vehicles

SIZES	LOAD SPEED/INDEX	TT/TL	TREAD DEPTH (MM)	PART #
FRONT				
100/90H-16	54H	TL	4.5	250068
110/70P-16	52P	TL	5.8	250079
110/70H-17	54H	TL	4.8	250070
110/80H-17	57H	TL	4.8	250071
90/90H-18	51H	TL	4.5	250075
100/90H-19	57H	TL	4.5	250078
REAR				
130/90H-15	66H	TL	6.5	250066
170/80H-15	77H	TL	7	250067
130/90H-16	74H	TL	6.5	250069
140/70P-16	65P	TL	6.8	250080
130/70H-17	62H	TL	6	250072
140/70H-17	66H	TL	6.8	250073
150/70H-17	69H	TL	7	250074
130/70H-18	63H	TL	6	250076
140/70H-18	67H	TL	6.8	250077

DUAL SPORT- K261

DUAL SPORT | K261



Leaning more towards street riding than trail riding? The K261 Dual Sport is the tire for you.

- DOT approved (20% dirt/80% road)
- Perfect for “on road” dual sport applications
- 4-ply rated casing design

SIZES	LOAD SPEED/INDEX	TT/TL	TREAD DEPTH (MM)	PART #
REAR				
120/90-17	64H	TL	6.5	250442

DUAL SPORT | K761



- 30% dirt / 70% road
- Chunky, aggressive design for street-oriented dual-sports
- Original equipment tires on models from several major manufacturers
- Gravel and fire road performance while maintaining excellent street manners
- Long tread life for one of the best value motorcycle tires on the market
- Available in 29 popular sizes for fitment on multiple motorcycle categories

SIZES	LOAD SPEED/INDEX	TT/TL	TREAD DEPTH (MM)	PART #
REAR				
90/90-21	54H	TL	8	250103

BIG BLOCK - K784

BIG BLOCK | K784



- Tread pattern provides high traction on a variety of terrain
- Large tread blocks for improved tread wear and high speed handling
- High impact, bias belting, casing structure providing a high level of puncture resistance
- Rubber compound designed specifically for wet-slick & dry-hard packed terrain
- DOT and E-mark approved (50%/50% dirt/road application)
- Tubeless

SIZES	PLY	PART #
FRONT		
100/90B19	4	250177
110/80B19	4	250178
120/70B19F	4	250435
90/90B21	4	250179
REAR		
130/80B17	4	250174
150/70B17	4	250173
170/60B17	4	250434
140/80B18	4	250176
150/70B18	4	250175

TRAKMASTER DTR K6342

- Aggressive shoulders and stepped biting edges providing exceptional control in the dirt.
- Uncompromised performance on any surface and in any terrain.
- Predictable traction on wet and dry paved surfaces.
- Proprietary rubber compound for the perfect blend of off-road traction and mileage performance.



SIZES	LOAD SPEED/ INDEX	TT/TL	MAX PSI	PART #
FRONT				
100/90B19	57T M+S	TL	41	250637
110/80B19	59T M+S	TL	42	250638
120/70B19	60T M+S	TL	41	250639
90/90B21	53T M+S	TL	41	250640
REAR				
150/80B16	71 M+S	TL	41	250641
120/90B17	64T M+S	TL	41	250642
130/80B17	65T M+S	TL	41	250643
140/80B17	69H M+S	TL	41	250644
150/70R17	69V M+S	TL	42	250645
140/80B18	70T M+S	TL	42	250646
150/70B18	70T M+S	TL	42	250647



KENDA
SINCE 1962 **TIRES**

TIRES & TRACKS

TUBES

CHEMICALS

TOOLS

BATTERIES

FUEL & INTAKE

AIR & OIL FILTERS



PIRELLI

FUEL YOUR
**RIDE AND
WALLET**



DIABLO™ SUPERCORSA SP - V4

STREET



- Directly derived from World SBK and engineered to unlock the full potential of your motorbike
- Dual compound front and rear layout applied on state-of-art profiles combine outstanding racetrack performance with ultimate riding pleasure on road
- Featuring the latest evolution of the patented FLASH tread pattern designed to enhance homogeneous thrust at any lean angle
- Engineered to provide maximum performance both on road with road-specific tyre pressures and on the racetrack with racetrack-specific tyre pressures (recommended 2.3bar front & 2.1bar rear when tyres are warm)

SIZES	LOAD/SPEED RATING	PART #
FRONT		
110/70ZR17	54W	747001
120/70ZR17	58W	747002

SIZES	LOAD/SPEED RATING	PART #
REAR		
140/70ZR17	66W	747003
150/60ZR17	66W	747004
180/55ZR17	73W	747005
180/60ZR17	75W	747006
190/50ZR17	73W	747007
190/55ZR17	75W	747008
200/55ZR17	78W	747009
200/60ZR17	80W	747010

DIABLO™ SUPERCORSA SP - V3



- Racetrack performance delivered via a fully street legal tyre
- New tread design geometry to better respond to the lateral forces and improve wear regularity
- New racing compound on shoulder, developed in the FIM World Superbike Championship
- New profiles to reach a new level of response, handling and grip both on racetrack and road
- Bi-Compound rear to combine grip, stability and mileage

SIZES	LOAD/SPEED RATING	PART #
FRONT		
120/70ZR17	58W	747011

SIZES	LOAD/SPEED RATING	PART #
REAR		
180/55ZR17	73W	747012
190/55ZR17	75W	747013
200/55ZR17	78W	747014

TIRES & TRACKS

TUBES

CHEMICALS

TOOLS

BATTERIES

FUEL & INTAKE

AIR & OIL FILTERS



SUPER SPORTS

DIABLO ROSSO™ IV CORSA



DIABLO ROSSO™ IV Corsa is intended for thrill seekers and bike-tuning enthusiasts looking for more than a supersport tyres. Just like professional riders can choose between different compound options for racing, all riders can select which version of DIABLO™ road sports tyres to use.

- Higher grip in dry conditions
- Enhanced hard handling
- Consistent performance over multiple severe riding sessions

SIZES	LOAD/SPEED RATING	PART #
FRONT		
110/70ZR17	54W	747015
120/70ZR17	58W	747016

SIZES	LOAD/SPEED RATING	PART #
REAR		
150/60ZR17	66W	747017
180/55ZR17	73W	747018
180/60ZR17	75W	747019
190/50ZR17	73W	747020
190/55ZR17	75W	747021
200/55ZR17	78W	747022
200/60ZR17	80W	747023

DIABLO ROSSO™ IV



- Superb grip while braking, thrust boost in extreme lean angles and brilliant traction exiting the corner
- Lightning handlebar response to rider inputs and smooth feedback while cornering
- WSBK-derived structures and contours
- Silica-enriched multi-compound for both front and rear tyres
- Best performance on road use, on both wet and dry roads

SIZES	LOAD/SPEED RATING	PART #
FRONT		
110/70ZR17	54H	747024
110/70ZR17	54W	747025
120/60ZR17	55W	747026
120/70ZR17	58W	747027

SIZES	LOAD/SPEED RATING	PART #
REAR		
140/70ZR17	66H	747028
150/60ZR17	66H	747029
150/60ZR17	66W	747030
160/60ZR17	69W	747031
180/55ZR17	73W	747032
180/60ZR17	75W	747033
190/50ZR17	73W	747034
190/55ZR17	75W	747035
200/55ZR17	78W	747036
200/60ZR17	80W	747037

DIABLO ROSSO™ III

SUPER SPORTS



- Pirelli technology developed within the World Superbike Championship
- Unprecedented handling for a new generation of sporty behaviour
- Bi-compound with wide side soft stripe offering full grip starting from mid lean angle
- Large footprint area for improved adherence

SIZES	LOAD/SPEED RATING	PART #
FRONT		
110/70ZR17	54W	747038
120/60ZR17	55W	747039
120/70ZR17	58W	747040
120/70ZR17	58W (D)	747041

SIZES	LOAD/SPEED RATING	PART #
REAR		
150/60ZR17	66W	747042
160/60ZR17	69W	747043
180/55ZR17	73W	747044
190/50ZR17	73W	747045
190/55ZR17	75W	747046
190/55ZR17	75W (D)	747047
240/45ZR17	82W	747048

DIABLO ROSSO™ II

The second generation of DIABLO ROSSO™ family: sport performance for every day road use.



- A Bi-Compound rear tyre combining long lasting mileage with excellent grip
- Pirelli Enhanced Patch Technology (EPT) optimizing the contact patch for improved grip
- Functional Groove Design (FGD) to optimise wet behavior

SIZES	LOAD/SPEED RATING	PART #
FRONT		
110/70ZR17	54H	747049
120/70ZR17	58W (D)	747050
120/70ZR17	58W (K)	747051

SIZES	LOAD/SPEED RATING	PART #
REAR		
140/70ZR17	66H	747052
160/60ZR17	69W	747053
170/60ZR17	72W	747054
180/55ZR17	73W	747055
190/50ZR17	73W	747056
190/55ZR17	75W	747057
200/50ZR17	75W	747058



STREET

DIABLO ROSSO™ SCOOTER

THE PIRELLI'S DIABLO™ DNA, BRINGING MOTORCYCLE PERFORMANCE ON A SCOOTER TYRE



- Motorcycle performance on a scooter tyre
- Improved handling, absolute grip and performance in the wet combining all the latest technologies, materials, processes, and know-how achieved by PIRELLI in the racing activities
- Dedicated to riders with a sporty riding style, both in the urban environment and/or on winding roads or mountain passes
- High Silica dual-compound in rear tyre for higher mileage and excellent grip in all conditions

SIZES	LOAD/SPEED RATING	PART #
REAR		
120/70R14	55H	747241
110/70-12	47P	747239
120/70-12	58P	747240
120/80-14	58S	747242
130/70-12	62P	747243
150/70-13	64S	747244
150/70-14	66S	747245

PIRELLI SL 60



The Pirelli SL60 is a popular dual-purpose/scooter tire designed to handle both urban streets and light off-road terrain. Here's a full breakdown based on dealer specs and reviews:

SIZES	LOAD/SPEED RATING	PART #
FRONT		
120/90 - 10	57J	747288
130/90 - 10	61J	747289
120/80 - 12	55J	747290



THE ORIGINAL CLASSIC TREAD PATTERN DESIGN THAT EQUIPPED THE MOST ICONIC SCOOTER MODELS

- Specific pattern with central carving to ensure excellent performance even on wet roads
- Classic-type tread with low profile and rigid carcass
- Optimized construction to ensure high stability on all routes even with the scooter fully loaded

SIZES	LOAD/SPEED RATING	PART #
FRONT		
3.00 - 10	42J	747286
3.50 - 10	51J	747287

ANGEL™ SCOOTER

THE GUARDIAN ANGEL™ FOR URBAN MOBILITY

- High comfort thanks to the combined action of stiff structures and tread pattern design
- New compound with a high percentage of silica for top wet performance
- Dynamic urban handling thanks to the new multi-radius contour that allows for a quick change of direction



SIZES	LOAD/SPEED RATING	PART #	SIZES	LOAD/SPEED RATING	PART #
FRONT			REAR		
3.00-10	50J	747246	120/70-11	56L	747266
3.50-10	59J	747247	120/70-12	58P	747267
80/100-10	46J	747248	130/70-12	62P	747268
100/90-10	56J	747249	140/70-12	65P	747269
120/90-10	66J	747250	130/60-13 M/C	60P	747270
130/90-10	61J	747251	130/70-13 M/C	63P	747271
110/70-11	45L	747252	140/60-13 M/C	63P	747272
110/70-12	47P	747253	140/70-13 M/C	61P	747273
110/90-12	64P	747254	150/70-13 M/C	64S	747274
120/70-12	51S	747255	100/80-14 M/C	54S	747275
110/70-13 M/C	48S	747256	100/90-14 M/C	57P	747276
110/90-13 M/C	56P	747257	110/80-14 M/C	59S	747277
120/70-13 M/C	53P	747258	120/80-14 M/C	58P	747278
80/80-14 M/C	43S	747259	140/60-14 M/C	64S	747279
120/70-14 M/C	55P	747260	140/70-14 M/C	68S	747280
120/70-15 M/C	56S	747261	150/70-14 M/C	66S	747281
90/80-16 M/C	51S	747262	130/80-15 M/C	63S	747282
100/80-16 M/C	50P	747263	120/80-16 M/C	60P	747283
110/70-16 M/C	52S	747264	130/70-16 M/C	61P	747284
90/90-10	50J	747265	140/70-16 M/C	65P	747285



SUPER SPORTS

SPORT DEMON™



- Uniform and progressive performance in all riding conditions thanks to the rear multi-radius profile
- High grip on wet and dry surfaces with excellent mileage
- A safe and reliable tyre in all riding situations, with a particularly favorable cost/quality ratio suitable for Sport Touring motorcycles

SIZES	LOAD/SPEED RATING	PART #
FRONT		
110/70-16	52P	747076
110/90-16	59V	747077
120/80V16	60V	747078
100/80-17	52H	747079
110/70-17	54H	747080
110/80-17	57H	747081
120/70-17	58H	747082
100/90-18	56H	747083
110/80-18	58V	747084
110/90-18	61V	747085
100/90-19	57V	747086

SIZES	LOAD/SPEED RATING	PART #
REAR		
140/70-15	69P	747087
130/90-16	57V	747088
150/80 V 16	71V	747089
110/80-17	57P	747090
130/70-17	62H	747092
130/80-17	65H	747093
130/90-17	68V	747094
140/70-17	66H	747095
150/70-17	69H	747096
110/90-18	61H	747097
120/80-18	62H	747098
120/90-18	65V	747099
130/70-18	63H	747100
130/80-18	66V	747101
140/70-18	67V	747102

PHANTOM™ SPORTSCOMP

The sport tyre featuring fascinating vintage tread pattern design and cutting-edge performance: the perfect fit for modern classic motorcycles.



- A “Classic” tread made with technology and compounds specific for medium – high performance bikes
- Good precision on entry into bends and easy handling on mixed routes
- Radial carcass structure with a steel belt at 0° for stability and a great feeling of control even on the most demanding surfaces

SIZES	LOAD/SPEED RATING	PART #
FRONT		
100/90-18	56H	747059

SIZES	LOAD/SPEED RATING	PART #
REAR		
150/70R17	69H	747060



- The ideal tyre for travellers using the bike for long road trips, with side bags and passenger, looking for safety on wet, stability and mileage
- The evolution of the Angel™ ST, stretching the concept of Sport Touring into Gran Turismo, bringing the sporty attitude to a wider range of usage conditions and for longer distances
- The new reference for mileage in Sport Touring tyres
- Excellency in wet performance and grip
- Top handling capabilities, typical of the Pirelli DNA
- Performance consistency until the end of the tyre's life
- Bi-compound
- Personalisable through sidewall rubber labels

SIZES	LOAD/SPEED RATING	PART #
FRONT		
120/70ZR17	58W	747061
120/70ZR17	58W (A)	747062
110/80ZR18	58W	747063
120/70ZR18	59W	747064
110/80R19	59V	747065

SIZES	LOAD/SPEED RATING	PART #
REAR		
150/70R17	69V	747074
160/60ZR17	69W	747066
180/55ZR17	73W	747067
180/55ZR17	73W (A)	747068
190/50ZR17	73W	747069
190/50ZR17	73W (A)	747070
190/55ZR17	75W	747071
190/55ZR17	75W (A)	747072
190/55ZR17	75W (D)	747073
160/60ZR18	70W	747075

MANDRAKE™ MT 15 CRUISER

- Reinforced carcass to ensure high stability in corners with excellent resistance to lacerations
- Pattern with specific deep central grooves to ensure safety and reliability on wet and dry surfaces
- Available in 14" and 16" diameters.



SIZES	LOAD/SPEED RATING	PART #
FRONT		
110/80-14	59J	747103

SIZES	LOAD/SPEED RATING	PART #
REAR		
90/80-16	51J	747104



CRUISER

NIGHT DRAGON™ & NIGHT DRAGON™ GT



- Better grip, road holding and look than standard tires for Custom/Cruiser motorcycles
- Designed for Custom motorcyclists that need tyres with high performance on the straight or in the twisties
- Excellent grip and a higher mileage
- Provides a very responsive ride with a good balance between reliability and life of the tyre
- Optimized for the new V-Twin engines with more power and higher torque
- EPT technology to optimize the area of contact in order to ensure great stability at high speeds and lightning quick acceleration
- GT version on selected rear sizes

SIZES	LOAD/SPEED RATING	PART #
FRONT		
130/90B16	67H	747105
130/90B16	73H	747106
150/80B16	71H	747107
130/80B17	65H	747108
140/75R17	67V	747109
130/70R18	63V	747110
100/90-19	57H	747111
110/90-19	62H	747112
130/60B19	61H	747113
120/70B21	68H	747114
90/90-21	54H	747115

SIZE	LOAD/SPEED RATING	PART #
REAR		
180/70B15	76H	747116
180/70R16	77H	747117
180/60B17*	81H	747118
240/40VR18	79V	747119
170/80B15~	77H	747120
130/90B16~	73H	747121
150/80B16~	77H	747122
180/65B16~	81H	747123
MU85B16~	77H	747124
180/60R16~	80H	747125
160/70B17~	79V	747126
200/55R17~	78V	747127
180/55B18~	80H	747128
(*) Reinforced		
(~) GT Version		

MT 66 ROUTE™



The equipment which combines an Old School traditional design with contemporary ease of handling and extended duration

- Excellent ride comfort even at full load thanks to the specific carcass materials
- High mileage and excellent performance on any kind of road surface thanks to the tread's very deep grooves
- Dedicated to custom, cruiser and touring motorcycles, this tyre ensures excellent comfort, easy steering and excellent mileage

SIZES	LOAD/SPEED RATING	PART #
FRONT		
120/90-17	64S	747129
80/90-21	48H	747130

SIZES	LOAD/SPEED RATING	PART #
REAR		
130/90-15	66S	747131
140/90-15	70H	747132
150/90-15	74h	747133
140/90-16	71H	747134



- Racing inspired structures for sporty cruisers motorcycles*
- Slick shoulder to enhance performance in dry condition
- The iconic flashy mark in the tread design, recalled also in the sidewall
- Silica enriched dual compound rear for high grip and control*
- Dynamic handling with high level of steering precision
- Excellent traction and stability at high speed
- High visibility sidewall design

SIZES	LOAD/SPEED RATING	PART #
FRONT		
100/90-19	57H	747333
110/90-19	62H	747334
130/60B19	61H	747335
130/60B21	63H	747336
130/90B16	73H	747329
150/80B16	71H	747330
160/60R18	70V	747332
160/70R17	73V	747331

SIZES	LOAD/SPEED RATING	PART #
REAR		
150/80B16	77H	747338
160/70B17	79V	747337
180/55B18	80H	747341
180/70B16	77H	747339
180/70R16	77V	747340
240/40VR18	(79V)	747342
260/40VR18	(84V)	747343

SCORPION™ RALLY STR

ADVENTURE/DUALSPORT



- Technological innovations provide traction on dirt, stability at high speeds, on-road handling agility and grip in all riding conditions
- A new compound, with a high content of silica, offers increased grip on both dry and wet surfaces, stability and a superior resistance to abrasion
- Increased width and length of the tyre's contour makes a larger contact patch for better stability
- Blocks are longer and wider, and the longitudinal distance between each line of knobs has been reduced to increase the contact patch, without compromising off-road traction
- Heat, generated by high speed, is distributed across a wider surface to prevent knob tearing

SIZES	LOAD/SPEED RATING	PART #
FRONT		
110/70R17	54H	747154
120/70R17	58V	747155
110/80R18	58H	747156
120/70R18	59V	747157
100/90-19	57V	747158
110/80R19	59H	747159
110/80R19	59V	747160
120/70R19	60V	747161
90/90-21	54V	747162

SIZES	LOAD/SPEED RATING	PART #
REAR		
130/80R17	65V	747163
140/80R17	69V	747164
150/60R17	66H	747165
150/70R17	69V	747166
170/60R17	72V	747167
180/55R17	73V	747168
150/70R18	70V	747169

OFFROAD



TABLE OF CONTENTS

AUTOMATIC
DISTRIBUTORS

BATTLECROSS X31 INTERMEDIATE TERRAIN

- True intermediate tire with improved traction in a broader range of terrain*
- Rear tire Cooling Fins™ promote consistent traction and feel under continuous use (such as during a moto) by dispersing heat and minimizing inflation pressure gain.
- Bunker Groove™ technology – Two great benefits!
 1. Increased casing flex in tread area improves lug contact for greater traction in harder terrain while helping to maintain sidewall stability.*
 2. Provides additional biting edges when lugs are fully embedded in soft terrain.*
- Symmetric front tire design enhanced with Castle Block™ promotes braking stability while increasing biting edges and contact pressure on soft and slippery surfaces.*
- Asymmetric rear tire tread design featuring Castle Block™ enhances cornering traction by increasing lateral biting edges.*
- Looking for a smaller intermediate terrain size? Check out the Battlecross X30.

*Comparison based on Battlecross X31 versus Battlecross X30 in internal testing. Results may vary depending upon proper tire and vehicle maintenance, surface conditions, and riding habits.



FRONT

REAR

TECHNICAL FEATURES



TIRE SIZE	LOAD SPEED	TIRE CONSTRUCTION & PATTERN	OVERALL DIAMETER	TREAD WIDTH	OTD 32NDS	(MEASURING RIM) APPROVED RIM	RECOMMENDED P.S.I.	PART #
FRONT								
80/100-21	51M	X31F BW TT	27.95	3.74	14	1.6	10-15	835570
90/100-21	57M	X31F BW TT	28.11	3.90	14	1.6	10-15	835571
REAR								
110/100-18	64M	X31R BW TT	26.89	5.2	20	2.15	10-15	835567
100/90-19	57M	X31R BW TT	26.85	4.8	19	1.85	10-15	835566
110/90-19	62M	X31R BW TT	27.28	5.24	20	2.15	10-15	835568
120/80-19	63M	X31R BW TT	27.52	5.35	20	2.15	10-15	835569

M59 CROSS COUNTRY-SOFT TERRAIN

The Living Legend! Off-Road Front Tire for varied intermediate terrain

FRONT



TIRE SIZE	LOAD SPEED	TIRE CONSTRUCTION & PATTERN	OVERALL DIAMETER	TREAD WIDTH	OTD 32NDS	(MEASURING RIM) APPROVED RIM	MAX P.S.I.	PART #
<i>FRONT</i>								
80/100-21	51M	M59 BW TT	28.0	3.7	15	1.60	10-15	835364

BATTLECROSS X10 Mud/Sand Terrain

- Battlecross X10 operates more effectively with greater flexibility in varying track conditions.1
- Innovative tread patterns developed specifically for deep bottomless sand and mud, maintains control and traction in adverse conditions.
- Front spiked tread pattern cuts a clean path and helps maintain control.
- Rear tread pattern with optimized block rigidity provides excellent traction in mud and sand and helps control sideslip.
- X10 rears are directional.
- Comparable tires: Dunlop MX12 & MX11, Michelin Starcross 5 Sand, Pirelli Scorpion MX Soft.

FRONT

REAR



TIRE SIZE	LOAD SPEED	TIRE CONSTRUCTION & PATTERN	OVERALL DIAMETER	TREAD WIDTH	OTD 32NDS	(MEASURING RIM) APPROVED RIM	RECOMMENDED P.S.I.	PART #
<i>FRONT</i>								
80/100-21	51M	X10F BW TT	28	3.74	14	1.6	10-15	835530
<i>REAR</i>								
90/100-16	51M	X10R BW TT	23.85	4.3	13	1.85	10-15	835599
100/90-19	57M	X10R BW TT	26.89	5.2	20	1.85	10-15	835531
110/90-19	62M	X10R BW TT	27.52	5.35	20	2.15	10-15	835532

BATTLECROSS X20 SOFT/INTERMEDIATE TERRAIN

- Available in most big bike sizes.
- Tread pattern and block design front and rear provides higher cornering grip and greater traction on soft terrain.1
- Convex “Castle Block” rear technology offers enhanced traction on a wider range of terrain conditions from soft to intermediate terrains. These additional square edges provide more bite.1
- X20 fronts are directional.
- Comparable tires: Dunlop MX33, Michelin Starcross 5 Soft, Pirelli Scorpion MX32 Mid Soft.



TIRE SIZE	LOAD SPEED	TIRE CONSTRUCTION & PATTERN	OVERALL DIAMETER	TREAD WIDTH	OTD 32NDS	(MEASURING RIM) APPROVED RIM	MAX P.S.I.	PART #
FRONT								
70/100-19	42M	X20F BW TT	24.88	3.27	12.67	(1.60) 1.60~1.85	33	835533
80/100-21	51M	X20F BW TT	27.8	3.8	16	1.60	10-15	835535
90/100-21	57M	X20F BW TT	28.1	3.9	16	1.60	10-15	835534
REAR								
90/100-16	51M	X20R BW TT	23.78	4.29	17.17	(2.15) 2.15~2.50	33	835536
110/100-18	64M	X20R BW TT	26.9	5.1	21	2.15	10-15	835537
100/90-19	57M	X20R BW TT	26.8	4.8	21	1.85	10-15	835539
110/90-19	62M	X20R BW TT	27.2	5.3	21	2.15	10-15	835540
120/80-19	63M	X20R BW TT	27.4	5.3	21	2.15	10-15	835538

BATTLECROSS X30 Intermediate Terrain

- Front tires feature Asymmetric Block Pattern which optimizes block placement to achieve stable grip under braking and cornering.
- Rear tires feature Cooling Fins on the sidewall for better heat dispersion which provides more consistent tire performance.1
- Convex “Castle Block” (rear) offers enhanced traction under acceleration and braking. The “block within a block” gives twice the square edges for more bite.1
- Crosses well between soft, intermediate and hard terrain.
- Comparable tires: Dunlop MX53, Michelin Starcross 5 Medium, Pirelli Scorpion MX32 Mid Hard.



TIRE SIZE	LOAD SPEED	TIRE CONSTRUCTION & PATTERN	OVERALL DIAMETER	TREAD WIDTH	OTD 32NDS	(MEASURING RIM) APPROVED RIM	MAX P.S.I.	PART #
FRONT								
70/100-19	42M	X30F BW TT	25.0	3.3	13	1.40	10-15	835541
REAR								
90/100-16	52M	X30R BW TT	23.7	4.3	13	1.85	10-15	835544

BATTLECROSS X40 INTERMEDIATE/HARD TERRAIN

- Available in most big bike sizes.
- Front tire features Asymmetric Tread Pattern which optimizes block placement to achieve stable grip under braking and cornering.
- Rear tires feature Cooling Fins on the sidewall for better heat dispersion which provides more consistent tire performance.1
- Convex “Castle Block” (rear) offers enhanced traction under acceleration and braking. The “block within a block” gives twice the square edges for more bite.1
- Comparable tires: Dunlop MX53 & MX71, Michelin Starcross 5 Hard, Pirelli Scorpion MX Hard.



TIRE SIZE	LOAD SPEED	TIRE CONSTRUCTION & PATTERN	OVERALL DIAMETER	TREAD WIDTH	OTD 32NDS	(MEASURING RIM) APPROVED RIM	MAX P.S.I.	PART #
FRONT								
80/100-21	51M	X40F BW TT	27.8	3.8	14	1.60	10-15	835550
90/100-21	57M	X40F BW TT	28.2	3.8	14	1.60	10-15	835551
REAR								
110/100-18	64M	X40R BW TT	26.8	5.2	20	2.15	10-15	835552
100/90-19	57M	X40R BW TT	26.8	4.8	18	1.85	10-15	835553
110/90-19	62M	X40R BW TT	27.3	5.2	20	2.15	10-15	835554
120/80-19	63M	X40R BW TT	27.4	5.3	20	2.15	10-15	835555

BATTLECROSS E50

- Specifically designed for the hardcore enduro rider.
- The E50 tire is optimized for a broad spectrum of off-road riding.
- Improved off-road traction due to a new front and rear tread pattern.1
- Raised lugs atop the primary lug, Castle Block technology gives more surface area and more “bite” for enhanced traction. This “block within a block” design gives twice the square edges for more bite.
- Improved off-road traction due to new front and rear tread patterns that include Castle Block Technology, increased block rigidity, and the additional biting edges of our bunker technology.1
- The E50 is easier to mount because of the optimized sidewall rigidity and the profile to improve rim fitting at the track or on the trail.1
- DOT certified.



TIRE SIZE	LOAD SPEED	TIRE CONSTRUCTION & PATTERN	OVERALL DIAMETER	TREAD WIDTH	OTD 32NDS	(MEASURING RIM) APPROVED RIM	MAX P.S.I.	PART #
FRONT								
90/90-21M/C	54P	Battlecross E50F BW TT	27.9	3.7	15	(2.15) 1.85~2.5	33	835233
REAR								
120/90-18M/C	65P	Battlecross E50R BW TT	26.7	5	16	(2.75) 2.5~3	33	835235
140/80-18M/C	70P	Battlecross E50R BW TT	27.1	5.5	16	(3.5) 2.75~3.75	33	835236

BATTLECROSS E50 EXTREME

- Soft enduro gummy compound provides increased grip.
- Advanced block positioning and Castle Block technology to maximize traction.
- Raised lugs atop the primary lug, Castle Block technology gives more surface area and more “bite” for enhanced traction. This “block within a block” design gives twice the square edges for more bite.
- Grip and traction improvements on all extreme enduro terrain.
- 1 size: 140/80-18 rear.
- Non-DOT.



TIRE SIZE	LOAD SPEED	TIRE CONSTRUCTION & PATTERN	OVERALL DIAMETER	TREAD WIDTH	OTD 32NDS	(MEASURING RIM) APPROVED RIM	MAX P.S.I.	PART #
REAR								
140/80-18	70M	BATTLECROSS E50 EXTREME	27.1	5.5	16	(3.5) 2.75~3.75	33	835234

ADVENTURE/DUAL SPORT

BATTLAX ADVENTURE A41

- Bridgestone’s third generation Adventure Touring tire delivers confidence inspiring performance and excellent life for a wide variety of bikes.
- Both front and rear feature 3LC (Dual Compound) with proprietary compounds to provide grip when it’s needed without sacrificing mileage.
- Tread patterns with deco groove for excellent wet weather performance and excellent agility and line-holding with an aggressive look.
- Both front and rear now use Mono-Spiral Belt construction for great stability in all conditions.



TIRE SIZE	LOAD SPEED	TIRE CONSTRUCTION & PATTERN	OVERALL DIAMETER	TREAD WIDTH	OTD 32NDS	(MEASURING RIM) APPROVED RIM	MAX P.S.I.	PART #
FRONT								
120/70ZR17M/C	58W	Battlax Adventure A41F	23.6	4.8	6	(3.5) 3.5~3.75	42	835100
120/70R15M/C	56V	Battlax Adventure A41F	21.6	5	6	(3.5) 3.5~3.5	42	835099
110/80R18M/C	58H	Battlax Adventure A41F	25	4.3	5	(2.5) 2.5~3	42	835101
100/90V19M/C	57V	Battlax Adventure A41F	26.1	4	6	(2.5) 2.15~2.75	42	835102
110/80R19M/C	54V	Battlax Adventure A41F	25.9	4.3	5	(2.5) 2.5~3	42	835103
120/70R19M/C	60V	Battlax Adventure A41F	25.6	4.7	5	(3.5) 3.5~3.75	41	835104
120/70ZR19M/C	60W	Battlax Adventure A41F	25.6	4.7	5	(3.5) 3.5~3.75	41	835105
90/90V21M/C	54V	Battlax Adventure A41F	27.4	3.5	6	(2.15) 1.85~2.5	41	835106
90/90-21M/C54	54H	Battlax Adventure A41F	27.4	3.6	6	(2.15) 1.85~2.5	41	835572
REAR								
130/80R17M/C	65H	Battlax Adventure A41R	25.2	5.1	11	(3) 3~3.5	41	835107
140/80R17M/C	69V	Battlax Adventure A41R	25.9	5.7	11	(3.5) 3~3.75	41	835108
150/70R17M/C	69V	Battlax Adventure A41R	25.2	5.9	11	(4.25) 4~4.5	42	835109
160/60ZR17M/C	69W	Battlax Adventure A41R	24.6	6.2	8	(4.5) 4.25~5.5	42	835110
170/60R17M/C	72V	Battlax Adventure A41R	25.1	6.6	11	(4.5) 4.5~5.5	41	835111
170/60ZR17M/C	72W	Battlax Adventure A41R	25.1	6.6	8	(4.5) 4.5~5.5	41	835112
180/55ZR17M/C	73W	Battlax Adventure A41R	24.8	7.1	8	(5.5) 5.5~6	42	835113
190/55R17M/C	75V	Battlax Adventure A41R	25.3	7.6	8	(6) 5.5~6	42	835114
190/55ZR17M/C	75W	Battlax Adventure A41R	25.2	7.5	8	(6) 5.5~6	42	835115
150/70R18M/C	70H	Battlax Adventure A41R	26.3	6	8	(4) 4~4.5	41	835116
150/70ZR18M/C	70W	Battlax Adventure A41R	26.3	6	8	(4.25) 4~4.5	41	835117

ADVENTURE/DUAL SPORT

BATTLAX ADVENTURE TRAIL AT41

- Improved wet traction, braking, and water drainage due to optimized groove design*
- 3LC + Cap & Base technology (rear only) promotes excellent wet & dry traction
- New compound for front tire promotes longer wear life and increases wet traction*
- MS Belt™ technology and new block pattern promotes stability
- M+S designation



TIRE SIZE	LOAD SPEED	TIRE CONSTRUCTION & PATTERN	LETTER CODE	OVERALL DIAMETER	TREAD WIDTH	OTD 32NDS	(MEASURING RIM) APPROVED RIM	MAX P.S.I.	PART #
FRONT									
100/90-19M/C	57V	Battlax Adventure Trail AT41F	UM	26.14	4.02	6	[2.5] 2.15~2.75	41	835557
90/90-21M/C	54V	Battlax Adventure Trail AT41F	UM	27.48	3.54	5	[2.15] 1.85~2.5	41	835565
REAR									
130/80R17M/C	65H	Battlax Adventure Trail AT41R	UM	25.16	5.08	9	[3] 3~3.5	41	835560
150/70R17M/C	69V	Battlax Adventure Trail AT41R	UM	25.24	6.06	0	[4.25] 4~4.5	41	835562
170/60R17M/C	72V	Battlax Adventure Trail AT41R	UM	25.08	6.61	9	[4.5] 4.25~5.5	41	835564
150/70R18MC	70V	Battlax Adventure Trail AT41R	UM	26.22	5.98	9	[4.25] 4~4.5	41	835563



BATTLAX ADVENTURECROSS AX41

- The BATTLAX ADVENTURECROSS AX41 tire offers improved off-road traction from an enhanced pattern design, compound, and high cross sectional area.*
- The compound, pattern design, and block wall angle optimization have improved the durability of the AX41.*
- The tread blocks feature Even-Wear Design, and have improved the performance on road by reducing block deformation due to step wear.*



TIRE SIZE	LOAD SPEED	TIRE CONSTRUCTION & PATTERN	OVERALL DIAMETER	TREAD WIDTH	OTD 32NDS	(MEASURING RIM) APPROVED RIM	MAX P.S.I.	PART #
FRONT								
100/90-18M/C	56P	Battlax Adventurecross AX41	25.1	4.0	10	(2.5) 2.15~2.75	33	835134
90/100-19M/C	55P	Battlax Adventurecross AX41	26.2	3.7	10	(2.15) 1.85~2.5	33	835138
100/90-19M/C	57Q	Battlax Adventurecross AX41	26.3	4	10	(2.5) 2.15~2.75	35	835135
110/80B19M/C	59Q	Battlax Adventurecross AX41	26.1	4.3	10	(2.5) 2.15~3	35	835136
120/70B19M/C	60Q	Battlax Adventurecross AX41	25.9	4.7	10	(3.5) 3.5~3.75	35	835137
2.75-21	45P	Battlax Adventurecross AX41	27.2	3.1	10	(1.8) 1.4~1.8	33	835139
3.00-21	51P	Battlax Adventurecross AX41	27.6	3.4	10	1.6	33	835140
80/100-21M/C	51P	Battlax Adventurecross AX41	27.6	3.1	10	(1.85) 1.60~2.15	33	835141
90/90-21M/C	54Q	Battlax Adventurecross AX41	27.6	3.5	10	(2.15) 1.85~2.5	35	835142
REAR								
120/90-16M/C	63P	Battlax Adventurecross AX41	24.4	5.0	12	(2.75) 2.5~3.0	33	835143
120/90-17M/C	64P	Battlax Adventurecross AX41	25.4	4.8	12	(2.75) 2.5~3.5	33	835145
130/80-17M/C	65P	Battlax Adventurecross AX41	25.5	5.1	12	(3.0) 2.5~3.5	33	835146
130/80B17M/C	65Q	Battlax Adventurecross AX41	25.3	5.0	12	(3) 2.5~3.5	35	835147
140/80B17M/C	69Q	Battlax Adventurecross AX41	26.1	5.6	12	(3.5) 2.75~3.75	35	835148
150/70B17M/C	69Q	Battlax Adventurecross AX41	25.6	5.9	12	(4.25) 3.5~4.5	35	835149
170/60B17M/C	72Q	Battlax Adventurecross AX41	25.4	6.6	12	(4.5) 4~5.5	35	835150
4.60-18	63P	Battlax Adventurecross AX41	25.91	4.6	15	2.15	33	835153
120/80-18M/C	62P	Battlax Adventurecross AX41	25.6	4.8	12	(2.75) 2.5~3.0	33	835154
120/90-18M/C	65P	Battlax Adventurecross AX41	26.5	4.8	12	(2.75) 2.5~3.0	33	835155
130/80-18M/C	66P	Battlax Adventurecross AX41	26.5	5.4	12	(3.0) 2.5~3.5	33	835156
150/70B18M/C	70Q	Battlax Adventurecross AX41	26.6	5.98	12	(4.25) 3.5~4.5	35	835157
4.00-18	64P	Battlax Adventurecross AX41	27.0	4.2	13	(2.5) 2.15~3.0	33	835151

TRAIL WING REPLACEMENTS

- Trail Wing TW301/302 are on-off dual purpose tires with the emphasis on street application. Excellent high speed stability, handling, and wet performance for all-round street use.



TIRE SIZE	LOAD SPEED	TIRE CONSTRUCTION & PATTERN	OVERALL DIAMETER	TREAD WIDTH	OTD 32NDS	(MEASURING RIM) APPROVED RIM	MAX P.S.I.	PART #
FRONT								
3.00-21	51S	TW301F BW TT	27.6	3.4	10	1.6	37	835518
REAR								
4.60-17	62P	TW302R BW TT	24.9	4.7	14	2.15	33	835520
4.60-18	63P	TW302R BW TT	25.9	4.6	15	2.15	33	835521

BATTLAX ADVENTURECROSS SCRAMBLER AX41S



The AX41S tire was developed specifically for the rider who wants classic Scrambler looks, but still desires Bridgestone performance and capability. The AX41S tire is truly where form meets function.

- Designed with the modern classic rider in mind.
- The touring tire compound and the 3LC™ tread for the rear promotes wet and dry performance.

TIRE SIZE	LOAD SPEED	TIRE CONSTRUCTION & PATTERN	TREAD DEPTH	OVERALL DIAMETER	PART #
FRONT					
120/70R17M/C	58H	BATTLAX ADVCROSS SCMBLR AX41S	6	23.7	835118
100/90-18M/C	56H	BATTLAX ADVCROSS SCMBLR AX41SF	6	25.1	835119
110/80R18M/C	58H	BATTLAX ADVCROSS SCMBLR AX41S	6	25	835120
130/80-18M/C	66P	BATTLAX ADVCROSS SCMBLR AX41S	7	26.2	835121
100/90-19M/C	57H	BATTLAX ADVCROSS SCMBLR AX41SF	6	26.1	835122
120/70R19M/C	60H	BATTLAX ADVCROSS SCMBLR AX41S	6	25.7	835123
REAR					
180/80-14M/C	78P	BATTLAX ADVCROSS SCMBLR AX41SR	9	25.6	835124
160/60R15M/C	67H	BATTLAX ADVCROSS SCMBLR AX41S	8	22.6	835125
130/80-17M/C	65H	BATTLAX ADVCROSS SCMBLR AX41SR	9	25.2	835126
160/60R17M/C	69H	BATTLAX ADVCROSS SCMBLR AX41S	8	24.6	835127
170/60R17M/C	72H	BATTLAX ADVCROSS SCMBLR AX41S	8	25	835128
180/55R17M/C	73H	BATTLAX ADVCROSS SCMBLR AX41S	9	24.8	835129

BATTLE WING

BATTLE WING BW-501/ BW-502



- 'G' 120/70 & 160/60 Honda NC750X 2016- Tubeless type.
- 'G' 110/80 & 150/70 BMW F800GS 2008-2017 & Triumph Tiger 800XC 2011-2017 Tube type.
- 'E' Yamaha XT1200Z Super Tenere 2010- Tubeless type.
- 'F' Honda VFR1200X Crosstourer 2012- Tubeless type.
- Robust construction | All-weather traction | Optimum wear resistance

TIRE SIZE	LOAD SPEED	TIRE CONSTRUCTION & PATTERN	TREAD DEPTH	OVERALL DIAMETER	PART #
FRONT					
110/80R19M/C	59V	BATTLEWING BW501F - E	6	25.9	835229
REAR					
150/70R17M/C	69V	BATTLEWING BW502R - E	10	25.3	835232

TRAIL WING

Adventure Tire

- 4.00-10 Bridgestone Trail Wing TW Dual Sport Scooter Tire
- Designed for off-road mini-bikes and dual sport scooters
- 2 ply rated bias carcass construction for front or rear use
- High-traction, self-cleaning tread block pattern
- This motorcycle tire is tube-type
- These dual sport motorcycle tires are J rated for speeds up to 62 mph



TIRE SIZE	LOAD SPEED	TIRE CONSTRUCTION & PATTERN	TREAD DEPTH	PART #
<i>FRONT</i>				
4.00-10	49J	TRAIL WING	8	835509

TRAIL WING TW2

Adventure Tire

- Tube Type
- Designed for off-road mini bikes
- High-traction, self-cleaning tread block pattern
- Front or rear use



TIRE SIZE	LOAD SPEED	TIRE CONSTRUCTION & PATTERN	TREAD DEPTH	PART #
<i>FRONT</i>				
3.50-8	35J	TRAIL WING TW2	8	835516

TRAIL WING TRAIL WING TW42

- Self-cleaning tread blocks give a traction edge for muddy and loose terrains
- Special dimpled tread pattern means many edges to maximize traction
- Provides balanced highway and off-road performance
- Long-wearing durability
- DOT approved
- Blackwall



TIRE SIZE	LOAD SPEED	TIRE CONSTRUCTION & PATTERN	TREAD DEPTH	OVERALL DIAMETER	PART #
<i>FRONT</i>					
120/90-17M/C	64S	TRAIL WING TW42R	11	25.51	835525

MX TIRES

M203 / M204

With sizing for small/mini bikes, the M203/M204 is ideal for soft and intermediate terrain. The M203 front motocross tire is a knobby motorcycle tire specifically designed to work best under these conditions, thanks to feedback and input from top motocross and supercross riders under race conditions.

The M203's directional pattern rotation was specifically designed to offer optimum stability and increased braking power. It pairs well with the M204 rear tire – another race-proven design with tread blocks spaced extra wide apart.

- M203 (front) has tire design technology working in a broad range of soft and intermediate terrain applications.
- M204 (rear) offers a race-proven tread pattern designed with extra wide block spacing for great drive performance and slide control on firm base soil.

TIRE SIZE	LOAD SPEED	TIRE CONSTRUCTION & PATTERN	TREAD DEPTH	PART #
FRONT				
70/100-17	40M	MOTOCROSS M203F	13	835347
70/100-19	42M	MOTOCROSS M203F	13	835348
REAR				
80/100-12	41M	MOTOCROSS M204R	15	835349
90/100-16	52M	MOTOCROSS M204R	18	835351



MX TIRES

M22 / M23

With sizing for small/mini bikes, the combination of the M23 front tire and M22 rear tire feature an innovative tread pattern, specifically designed for hard-packed surfaces. These knobby tires have been proven and perfected on race tracks, resulting in tread compounds built for long life and maximum grip.

TIRE SIZE	LOAD SPEED	TIRE CONSTRUCTION & PATTERN	TREAD DEPTH	OVERALL DIAMETER	PART #
FRONT					
2.50-19	40M	M23	9	24.7	835355
REAR					
90/100-14	49M	M22	15	21.4	835352
3.00-16	43M	M22	14	23	835353



M40

Let's not forget the kids and the mini bikes. For the next generation of dirt riders, the M40 is the off-road motorcycle tire of choice, available in 10-inch sizes for nearly all popular mini bikes.

The knobs are large and wrap around to the edges of the tire, just like full-size MX tires, giving your little rider climbing traction to help get themselves out of ruts. Lastly, the 4-ply construction means the M40 tires are durable.

- Impressive grip and handling.
- Available in both 2.50-10 & 2.75-10 sizing.



TIRE SIZE	LOAD SPEED	TIRE CONSTRUCTION & PATTERN	TREAD DEPTH	OVERALL DIAMETER	PART #
FRONT					
2.50-10	33J	MOTOCROSS M40	10	15.4	835356
REAR					
2.75-10	38J	M40A REAR	11	15.5	835357

MX TIRES

M403 / M404

The M403/M404 is one of Bridgestone's most versatile off-road tires for small/mini bikes. As our do-it-all off-road tire in these sizes, the M403/M404 is an all-terrain motorcycle tire that crosses well between soft, intermediate, and hard terrain.

Designed by Bridgestone in these size tires for motocross and off-road, the tread design and rubber compound were derived directly from racing with the top SX/MX and Off-Road teams.

- Race-proven Tread Design Patterns & Rubber Compounds.
- Fine-Tuned Casing Constructions.
- Derived from top factory SX/MX and Off-Road Racing Technologies.
- Good durability & covers a wide range of soils.
- M403 (front) provides Cornering Control & Feedback even at full lean angles.
- M404 (rear) offers Traction & Slide Control for strong acceleration out of corners.



TIRE SIZE	LOAD SPEED	TIRE CONSTRUCTION & PATTERN	TREAD DEPTH	OVERALL DIAMETER	PART #
FRONT					
60/100-12	33M	MOTOCROSS M403F	9	17.1	835358
60/100-14	30M	MOTOCROSS M403F	11	19.3	835359
REAR					
80/100-12	41M	MOTOCROSS M404R	15	18.2	835362
90/100-14	49M	MOTOCROSS M404R	17	21.5	835363

MX TIRES

TRAIL WING

TRAIL WING TW101 / TW152

The Bridgestone TW101 / TW152 Tires offer strong traction in both street and dual sport conditions and provide exceptional highway stability.

- Four-ply front/rear combination designed for dual-sport use
- Special dimpled tread pattern means many edges to maximize traction
- Long-wearing durability
- Self-cleaning tread blocks give a traction edge for muddy and loose terrain
- DOT approved



TIRE SIZE	LOAD SPEED	TIRE CONSTRUCTION & PATTERN	TREAD DEPTH	OVERALL DIAMETER	PART #
FRONT					
110/80R19	59H	-	-	-	835510
REAR					
150/70R17	69H	-	-	-	835512
130/80R17	65H	-	-	-	835513

TRAIL WING TW18

Explore the Trail Wing TW18 tire. Increase the traction, performance, and durability of your adventure motorcycle.

TIRE SIZE	LOAD SPEED	TIRE CONSTRUCTION & PATTERN	TREAD DEPTH	OVERALL DIAMETER	PART #
FRONT					
4.10-18	59P	TRAIL WING TW18R	13	-	835515

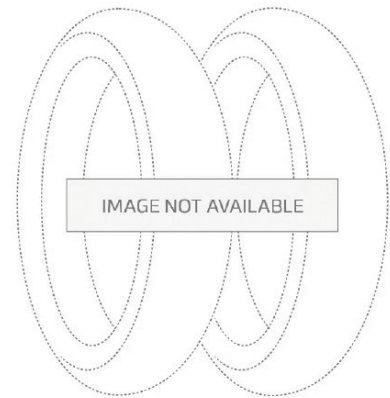

TRAIL WING

TRAIL WING TW301 / TW302

Trail Wing TW301/302 are on-off dual purpose tires with the emphasis on street application. Excellent high speed stability, handling, and wet performance for all-round street use.

TIRE SIZE	LOAD SPEED	TIRE CONSTRUCTION & PATTERN	TREAD WIDTH	OVERALL DIAMETER	PART #
FRONT					
80/100-21M/C	51P	-	3.3	27.5	835519
REAR					
120/80-18M/C	62P	-	4.7	25.7	835522



TRAIL WING TW31

Original Equipment (OE) for adventure bikes

TIRE SIZE	LOAD SPEED	TIRE CONSTRUCTION & PATTERN	TREAD DEPTH	OVERALL DIAMETER	PART #
<i>FRONT</i>					
130/80-18M/C	66P	TRAIL WING TW31F	9	26.18	835523

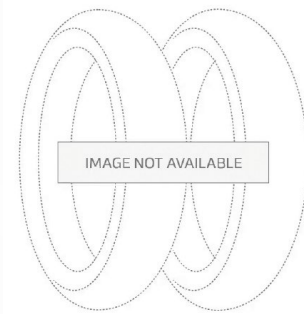

TRAIL WING TW34

Original Equipment (OE) tire for Adventure bikes.

TIRE SIZE	LOAD SPEED	TIRE CONSTRUCTION & PATTERN	TREAD DEPTH	OVERALL DIAMETER	PART #
<i>REAR</i>					
180/80-14M/C	78P	TRAIL WING TW34	11	25.4	835524



TRAIL WING TW42

Original Equipment (OE) Dual Sport tire.

TIRE SIZE	LOAD SPEED	TIRE CONSTRUCTION & PATTERN	TREAD DEPTH	OVERALL DIAMETER	PART #
<i>REAR</i>					
120/90-18M/C	65P	TRAIL WING TW42R	7	26.5	835526



TRAIL WING TW52

Explore the Trail Wing TW52 tire. This model balances highway and off-road performance on Adventure motorcycles

TIRE SIZE	LOAD SPEED	TIRE CONSTRUCTION & PATTERN	TREAD DEPTH	OVERALL DIAMETER	PART #
<i>REAR</i>					
4.60-18	63S	TRAIL WING TW52	14	-	835527

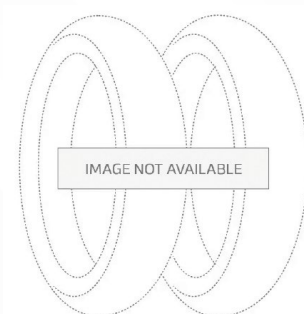

TRAIL WING TW9

Original Equipment (OE) Dual Sport tire.

TIRE SIZE	LOAD SPEED	TIRE CONSTRUCTION & PATTERN	TREAD DEPTH	OVERALL DIAMETER	PART #
<i>FRONT</i>					
2.50-16	36L	TRAIL WING TW9F	7	-	835528
3.00-23	56P	TRAIL WING TW9F	10	-	835529





K KENDA
TIRES



**CONQUER ANY
TERRAIN WITH KENDA**

OFFROAD

M2
KENDA MILLVILLE II



PARKER DT - K772



The second iteration of the Parker DT was developed in BAJA to get through the nastiest conditions on earth. The classic Carlsbad pattern is back along with an updated compound to help make the ultimate southwest tire!

- Our classic Carlsbad pattern is back in the Parker DT
- The ultimate tire for desert terrain!
- Casing/compound designed to meet the demands of the toughest hard-packed terrain
- 6-ply rated casing offers 30% more cut resistance
- Natural rubber compound for extended tread wear and reduced knob chunking
- DOT approved
- Available in 5 popular sizes

SIZES	LOAD SPEED/INDEX	TT/TL	PART #
REAR			
110/100-18 (425/450-18)	64M	TT	250309
120/100-18 (500/530-18)	68M	TT	250311
110/90-19	62M	TT	250310
120/90-19	66M	TT	250530

EQUILIBRIUM - K787



DOT approved for 2016!* EQUILIBRIUM: Trials meets Enduro in perfect harmony! The best qualities of a trials tire and motocross tire all in one product. Super sticky race compound for unbeatable grip in both wet and dry conditions.

- The best quality of trials tire and off-road tire all in one product
- Trials inspired center tread design for the best possible traction
- Motocross-style shoulder knobs for aggressive cornering
- Super sticky race compound for unbeatable grip in both wet and dry conditions
- Braking scoops in center area provide the stopping power that a trials tire can't
- Ultra soft casing for maximum terrain adaptation
- DOT approved

SIZES	LOAD SPEED/INDEX	TT/TL	PART #
REAR			
450-18 (110/100-18)	70M	TT	250522
120/80-19	63M	TT	250523

IBEX - K774



Ibex - Climb like a mountain goat!

- Designed for Endurocross and extreme enduro-type conditions.
- Super-Soft and flexible rubber compound for maximum bump absorption and terrain compliance for obstacles like rock gardens and log crossings
- High wet-traction compound developed by top pro Endurocross riders
- Open aggressive drive pattern for max grip and cleanout
- Shoulder knob pattern designed for large contact patch and support for soft compound during cornering
- Ultra soft casing for maximum terrain adaptation
- Made for low speed riding only (less than 40 mph recommended)

SIZES	LOAD SPEED/INDEX	TT/TL	TREAD DEPTH (MM)	PART #
FRONT				
80/100-21	51M	TT	11	250565
90/100-21	57M	TT	11	250566
REAR				
110/100-18	64M	TT	16	250524
120/100-18	68M	TT	16	250525
120/90-19	66M	TT	16	250585
90/100-14	49M	TT	14	250583
90/100-16	52M	TT	14	250584

SOUTHWICK II- K780



The Southwick II builds upon the success of the original Southwick. There is no better tire for soft sandy conditions!

- Designed for sand and mud conditions
- Front and rear tread pattern offer tall knob depths for deep bite
- Large radius support at knob base reduces knob roll in soft areas with hard base
- Wide space between rows self-cleans tread even at slow speed
- Standard compound allows for increased wear durability and offers quick warm-up on cement start pads
- Lightweight 4-ply rated casing structure with reinforced sidewalls
- DOT Approved front tire
- Available in 5 popular sizes Made for low speed riding only (less than 40 mph recommended)

SIZES	LOAD SPEED/INDEX	TT/TL	TREAD DEPTH (MM)	PART #
FRONT				
80/100-21 (300/325-21)	51M	TT	11	KD78005
REAR				
100/100-18 (350/410-18)	59M	TT	17	KD78001
110/100-18 (425/450-18)	64M	TT	17	KD78002
100/90-19	57M	TT	17	KD78003
110/90-19	62M	TT	17	KD78004

SAND MAD

| K782 / K782A



This is the perfect tire for nasty weather and sandy/muddy conditions. Always make sure have one in the trailer ready to go!

- This is the perfect tire for nasty weather and sandy/muddy conditions
- Always make sure have one in the trailer ready to go!
- Designed specifically for deep mud or sandy MX course conditions
- Paddle shape knobs create a large scoop for improved acceleration traction
- Sticky rubber compound for high traction

SIZES	LOAD SPEED/INDEX	TT/TL	TREAD DEPTH (MM)	PART #
REAR				
100/90 - 19	57M	TT	16.50	250313
110/90 - 19	62M	TT	16.00	250314
110/100 - 18	64M	TT	17.00	250608

GAUNTLET K779

GAUNTLET

| K776F / K779



- Next generation of legendary Washougal featuring dual-compound technology
- Rear: Standard compound in center for durability, Sticky compound in shoulder area for cornering stability & traction
- All new rear tread pattern for improved efficiency in a wider variety of course conditions
- Youth sizes feature Sticky compound only

SIZES	LOAD SPEED/INDEX	TT/TL	TREAD DEPTH (MM)	PART #
REAR				
130/80-18	66R	TT	13	250590

KENDA

OFFROAD

MILLVILLE II - K775



Kenda's next generation answer to the ever-popular Millville tire has made quite a splash in the Motocross and Off-Road circuits. This tire is designed to work extremely well in soft to intermediate conditions.

- Directionally designed for soft or intermediate terrain, perfect for MX
- New compound formula provides the best of both worlds, traction and durability
- Improved braking traction due to paddle shape pattern
- Improved cornering traction with more biting edges
- Tie bar knob support to reduce know squirm and increase durability
- DOT approved front tire (21" only)
- Available in 14 popular sizes



SIZES	LOAD SPEED/INDEX	TT/TL	TREAD DEPTH (MM)	PART #
FRONT				
60/100-14	30M	TT	9.00	250396
70/100-17	40M	TT	9.50	250399
70/100-19	42M	TT	9.50	250400
80/100-21	51M	TT	12.00	250407
90/100-21	57M	TT	12.00	250408
REAR				
80/100-12	41M	TT	13.00	250395
90/100-14	49M	TT	13.50	250397
90/100-16	52M	TT	13.50	250398
110/100-18	64M	TT	16.00	250401
120/100-18	68M	TT	16.00	250402
100/90-19	57M	TT	16.00	250403
110/80-19	59M	TT	16.00	250404
110/90-19	62M	TT	16.00	250405
120/80-19	63M	TT	16.00	250406



WASHOUGAL

K782



The ultimate intermediate terrain tire is here at Kenda. The Washougal II off-road tires offer dual-compound technology at its finest. The standard compound in the center offers maximum durability while the soft race compound in the shoulder provides cornering stability and optimal traction. These motocross and off-road tires have a new tread pattern that allows for maximum efficiency in a wide variety of terrains and conditions, so for the true riding enthusiast with a real sense of adventure, these are the off-road tires for you.

- Next generation of legendary Washougal featuring dual-compound technology
- Rear: Standard compound in center for durability, Sticky compound in shoulder area for cornering stability & traction
- Front: Single Compound
- All new rear tread pattern for improved efficiency in a wider variety of course conditions
- Youth sizes feature Sticky compound only
- DOT approved front tire (21" only)
- Available in 17 sizes

SIZES	LOAD SPEED/INDEX	TT/TL	TREAD DEPTH (MM)	PART #
FRONT				
250-10	33J	TT	7.50	250460
250-12	33J	TT	7.50	250461
60/100-14	30M	TT	9.50	250464
70/100-19	42M	TT	9.50	250468
REAR				
100/90-19	57M	TT	16.00	250471
110/100-18	64M	TT	16.00	250469
110/80-19	59M	TT	16.00	250472
110/90-19	62M	TT	16.00	250473
120/100-18	68M	TT	16.00	250470
120/80-19	63M	TT	16.00	250474
80/100-10	41J	TT	13.00	250462
80/100-12	41J	TT	13.00	250463
90/100-14	49J	TT	13.50	250465
90/100-16	52M	TT	13.50	250466

WASHOUGAL II

K775FA / K786



- Next generation of legendary Washougal featuring dual-compound technology
- Rear: Standard compound in center for durability, Sticky compound in shoulder area for cornering stability & traction
- Front: Single Compound
- All new rear tread pattern for improved efficiency in a wider variety of course conditions
- Youth sizes feature Sticky compound only

SIZES	LOAD SPEED/INDEX	O.D. (IN)	TREAD DEPTH (MM)	PART #
FRONT				
80/100-21	51M	28	12	250531
90/100-21	57M	28	12	250532
70/100-17	40M	23	10	250567

TRIPLE

TRIPLE K781



- Developed and tested in Arenacross and Supercross races
- Low Profile sidewall for improved cornering stability and cornering traction
- Tread pattern designed for hard packed, slippery surfaces
- Dimpled knobs allow for quick tire warm up and extra traction
- Lightweight 4-ply rated casing structure with reinforced sidewalls
- Sticky rubber compound for high traction
- DOT approved front tire

SIZES	LOAD SPEED/INDEX	O.D. (IN)	TREAD DEPTH (MM)	PART #
REAR				
120/100-18	68M	27	14.5	250605
100/90-19	57M	27	14.5	250606
110/90-19	62M	27	14.5	250607

TRAKMASTER 2- K760

TRAKMASTER 2 K760



- Tall aggressive knobs designed for varying terrain
- DOT approved (90%/10% dirt/road application)
- Durable compound for extended tread life
- Classic design at affordable price
- Tube type
- Available in 16 popular sizes

SIZES	LOAD SPEED/INDEX	TT/TL	TREAD DEPTH (MM)	PART #
FRONT				
250 - 10	38M	TT	6	KD76001
60/100 - 14	38M	TT	7.5	KD76002
70/100 - 17	46M	TT	9.5	KD76003
80/100 - 21	51M	TT	12.5	KD76004
REAR				
80/100 - 12	50M	TT	9.5	KD76005
90/100 - 14	49M	TT	13.5	KD76006
90/100 - 16	58M	TT	13	KD76007
110/100 - 18	64M	TT	16.5	KD76008
100/90 - 19	57M	TT	15.5	KD76009
110/90 - 19	62M	TT	16.5	KD76010
120/90-19	66M	TT	17	KD76011

DUAL SPORT
| K270



- Perfect replacement for OEM dual sport tires
- DOT approved (40%/60% dirt/road application)
- 40 and 6-ply rated casings
- Tube type
- Available in 15 popular sizes

SIZES	LOAD SPEED/ INDEX	TT/TL	TREAD DEPTH (MM)	PART #
FRONT				
275 - 21	43P	TT	7	250093
300 - 21	51P	TT	9.5	250094
325 - 21	57P	TT	9	250095
REAR				
325 - 17	50P	TT	9	250436
460 - 17	50M	TT	6	250082
400 - 18	64P	TT	12	250439
510 - 17	49M	TT	6	250083
275 - 18	58M	TT	4	250084
350 - 18	64M	TT	4	250085
410 - 18	62M	TT	4	250087
450 - 18	68M	TT	6	250088
510 - 18	58M	TT	6	250090
100/90 - 18	64M	TT	4	250091
110/100-18	63P	TT	14	250441
120/80 - 18	68M	TT	4	250092

KNARLY

KNARLY
| K777F / K778



- Extreme enduro FIM-approved
- Super-soft and flexible for ultimate terrain compliance and grip.
- Compound provides highest traction in both wet and dry conditions.
- reversible rear for variable terrain applications.
- available in super wide rear and 3 other popular sizes

SIZES	LOAD SPEED/ INDEX	O.D. (in)	TREAD DEPTH (MM)	PART #
FRONT				
90/90-21	54R	28	12	250587
REAR				
120/90-18	65R	27	12	250588
140/80-18	70R	27	13	250589

KLASSIC | K257D



- Sizes for most Modern and Vintage MX and Off-Road Motorcycles
- Knob Pattern provides traction in a variety of terrains
- 14 popular sizes
- Old skool design adds flavor to Vintage Motorcycles
- Rubber Compound engineered for high grip and long lasting tread wear.
- Most sizes DOT Approved

SIZES	LOAD SPEED/ INDEX	O.D. (IN)	TREAD DEPTH (MM)	PART #
FRONT				
300-21 (80/100-21)	51M	28	10	250544
REAR				
410-14	47M	22	14	250546
530-18	75M	28	16	250553





OFFROAD

KENDA

KENDA
SINCE 1962 **TIRES**

- TIRES & TRACKS
- TUBES
- CHEMICALS
- TOOLS
- BATTERIES
- FUEL & INTAKE
- AIR & OIL FILTERS



MAXXIS

**NO LIMITS
JUST TRAILS!**

MAXXCROSS SI



MAXXCROSS IT

A staple in the Maxxcross lineup, the IT is known to be very long lasting: An excellent value for the hardcore pro motocrosser or the grizzled weekend warrior XC rider.

- Knob design offers precise steering for a wide variety of soil conditions
- Known as a very long-wearing intermediate motocross tire that performs exceptionally well in common intermediate to hardpack conditions



PART #	MFG. #	POSITION	SIZE	LOAD SPEED RATING	OVERALL DIAMETER (IN)	MAX PSI	RIM SIZE (IN)	TREAD DEPTH (IN)
RIM SIZE (IN) 10								
844250	TM09866000	Front	2.50-10	33J TT	15.7	36	1.50X10	11/32*
844266	TM10375000	Rear	2.75-10	38J TT	15.5	36	1.50X10	11/32*
RIM SIZE (IN) 12								
844251	TM09868000	Front	2.50-12	42J TT	17.1	33	1.50X12	9/32*
844267	TM16795000	Rear	80/100-12	50M TT	18.3	32	1.60X12	16/32
RIM SIZE (IN) 14								
844252	TM19800000	Front	60/100-14	30M TT	19.4	32	1.40X14	12/32*
844268	TM26270000	Rear	90/100-14	49M TT	21.4	32	1.60X14	17/32
RIM SIZE (IN) 16								
844269	TM30012000	Rear	90/100-16	51M TT	23.5	32	1.85X16	17/32
RIM SIZE (IN) 17								
844253	TM38810000	Front	70/100-17	40M TT	22.9	32	1.40X17	14/32
844257	TM39073000	Rear	100/100-17	58M TT	24.8	32	1.85X17	18/32
RIM SIZE (IN) 18								
844258	TM52612000	Rear	100/100-18	59M TT	26.5	32	1.85X18	23/32
844260	TM73514000	Rear	110/100-18	64M TT	27	32	2.15X18	23/32
844263	TM76947000	Rear	120/100-18	68M TT	27.5	32	2.50X18	23/32
RIM SIZE (IN) 19								
844254	TM77950000	Front	70/100-19	42M TT	25	32	1.40X19	13/32
844262	TM78725000	Rear	110/90-19	62M TT	27.2	32	2.15X19	21/32
844265	TM79107000	Rear	120/90-19	66M TT	28.1	32	2.15X19	23/32
844259	TM87918000	Rear	100/90-19	57M TT	26.9	32	1.85X19	21/32
RIM SIZE (IN) 21								
844255	TM88181000	Front	80/100-21	51M TT	27.8	32	1.60X21	14/32
844256	TM89949000	Front	90/100-21	57M TT	28.1	32	1.85X21	15/32



MAXXCROSS DESERT IT



With a design based on the popular Maxxcross IT tread pattern, the Maxxcross Desert IT has a specially engineered compound that increases durability in rocky or desert conditions by reducing chipping and cutting.

- Stiffer tire carcass design minimizes flex, reducing the chance of pinched tubes
- Tall knob design improves traction when racing in sandy conditions
- Tread compound optimized for longevity and to perform in a wide variety of desert terrains
- Buy Now

PART #	MFG. #	POSITION	SIZE	LOAD SPEED RATING	OVERALL DIAMETER (IN)	MAX PSI	RIM SIZE (IN)	TREAD DEPTH (IN)
RIM SIZE (IN) 18								
844272	TM73518100	Rear	110/100-18	64M TT	27	32	2.15X18	23/32
844273	TM76951000	Rear	120/100-18	68M TT	27.5	32	2.50X18	23/32
RIM SIZE (IN) 19								
844274	TM78411000	Rear	110/80-19	59M TT	26.6	32	2.15X19	21/32
844276	TM78728000	Rear	110/90-19	62M TT	27.2	32	2.15X19	21/32
844277	TM78771000	Rear	120/80-19	63M TT	27.2	32	2.15X19	21/32
844278	TM79106100	Rear	120/90-19	66M TT	28.1	32	2.15X19	23/32
RIM SIZE (IN) 21								
844270	TM88187100	Front	80/100-21	51M TT	28	32	1.60X21	17/32
844271	TM89948100	Front	90/100-21	57M TT	28.1	32	1.85X21	15/32

MAXXCROSS SM



Don't get stuck in the mud or buried in the sand: Pin it and win it with a pair of Maxxcross SM tires.

- Anti-flex knob bridges on shoulder reinforce side knobs for increased traction
- Computer-enhanced pattern design ensures optimal traction from sandy motocross tracks to muddy cross country loops
- Specially formulated silica rubber compound and open tread pattern provide excellent self-cleaning tire characteristics

PART #	MFG #	POSITION	SIZE	LOAD SPEED RATING	OVERALL DIAMETER (IN)	MAX PSI	RIM SIZE (IN)	TREAD DEPTH (IN)
RIM SIZE (IN) 19								
844318	TM79110000	Rear	120/90-19	66M TT	27.5	32	2.15X19	22/32
RIM SIZE (IN) 21								
844313	TM88184000	Front	80/100-21	51M TT	28.2	32	1.60X21	17/32

Developed and tested at the Grand National Cross Country Series, the SI's race-proven tire construction delivers excellent traction and maximum durability in soft/intermediate conditions.



- Maxxcross SI is a go-to tire for our GNCC and WORCS pros
- Anti-flex knob bridges on side lugs offer solid straight-line stability and enhance grip for aggressive cornering
- Race-proven rubber compound delivers excellent traction and durability in soft/intermediate conditions on the motocross track or off-road

PART #	MFG. #	POSITION	SIZE	LOAD SPEED RATING	OVERALL DIAMETER (IN)	MAX PSI	RIM SIZE (IN)	TREAD DEPTH (IN)
RIM SIZE (IN) 10								
844289	TM09871000	Front	2.50-10	33J TT	15.4	36	1.50X10	11/32*
844296	TM10376000	Rear	2.75-10	38J TT	15.5	36	1.50X10	11/32*
RIM SIZE (IN) 12								
844297	TM16796000	Rear	80/100-12	41M TT	18.4	32	1.60X12	15/32
RIM SIZE (IN) 14								
844291	TM19810000	Front	60/100-14	30M TT	19.1	32	1.40X14	12/32*
844298	TM26275000	Rear	90/100-14	49M TT	21.4	32	1.60X14	17/32
RIM SIZE (IN) 16								
844299	TM30014000	Rear	90/100-16	52M TT	23.5	32	1.60X16	16/32
RIM SIZE (IN) 17								
844292	TM38811000	Front	70/100-17	40M TT	23	32	1.40X17	14/32
RIM SIZE (IN) 18								
844300	TM52614000	Rear	100/100-18	59M TT	26.4	32	1.85X18	21/32
844301	TM73517000	Rear	110/100-18	64M TT	27	32	2.15X18	21/32
844307	TM76946000	Rear	120/100-18	68M TT	27.4	32	2.50X18	21/32
RIM SIZE (IN) 19								
844293	TM77980000	Front	70/100-19	42M TT	24.9	32	1.40X19	12/32*
844304	TM78724000	Rear	110/90-19	62M TT	27.2	32	2.15X19	21/32
844305	TM78790000	Rear	120/80-19	63M TT	27.3	32	2.50X19	21/32
844306	TM79108000	Rear	120/90-19	66M TT	28	32	2.15X19	21/32
844302	TM87916000	Rear	100/90-19	57M TT	26.8	32	1.85X19	21/32
RIM SIZE (IN) 21								
844294	TM88185000	Front	80/100-21	51M TT	27.9	32	1.60X21	15/32
844295	TM89947000	Front	90/100-21	57M TT	28.1	32	1.85X 21	15/32

MAXXCROSS MX-ST



The Maxxcross MX-ST is the newest most advanced tire in our MX lineup. Designed and tested with 7X Supercross champion Jeremy McGrath, the new tread pattern, compound, and tire composition provide the stability, predictability, and traction that the top tiers of motocross demand.

- Lightweight pliable carcass design improves ride comfort, impact absorption, and rider feel
- Racing specific compounds deliver excellent traction and stability
- Tread pattern designed to optimize traction and braking performance while inspiring confidence and predictability in intermediate to soft soil conditions

PART #	MFG. #	POSITION	SIZE	LOAD SPEED RATING	OVERALL DIAMETER (IN)	MAX PSI	RIM SIZE (IN)	TREAD DEPTH (IN)
RIM SIZE (IN) 19								
844334	TM78701000	Rear	110/90-19	62M TT	27.4	33	2.15X19	20/32

INTERMEDIATE M6001



The M6001 performs in a variety of intermediate motocross and cross country terrains. Grab a set and see for yourself!

- 6-ply rating increases stability and puncture resistance
- Double-curved tread design with deep knobs delivers extraordinary traction for enhanced performance
- Reinforced bead with extra nylon adds strength and reduces bead-breaking
- Special high-performance rubber compound provides outstanding grip while reducing tread wear and chunking
- Unique knob and groove tread design offers exceptional handling through hard, intermediate, and soft conditions

MFG #	POSITION	SIZE	LOAD SPEED RATING	OVERALL DIAMETER (IN)	MAX PSI	RIM SIZE (IN)	TREAD DEPTH (IN)	PART #
RIM SIZE (IN) 14								
TM26255000	Rear	90/100-14	49M TT	21.5	33	1.60 X 14	19/32	844319
RIM SIZE (IN) 17								
TM50805000	Rear	130/90-17	68M TT	25.9	33	3.00 X 17	20/32	844321
RIM SIZE (IN) 18								
TM73510000	Rear	110/100-18	64M TT	26.2	33	2.15 X 18	19/32	844322
TM76945000	Rear	120/100-18	68M TT	26.8	33	2.50 X 18	20/32	844323
RIM SIZE (IN) 19								
TM78233000	Rear	100/90-19	57M TT	26.7	33	1.85 X 19	21/32	844324
TM78700000	Rear	110/90-19	62M TT	27.2	33	2.15 X 19	21/32	844325

DTR-1



Dirt track racers will delight in the performance of the DTR-1: superb traction and ultimate control for a variety of track conditions.

- Available in a variety of racing compounds:
- CD3 = Soft compound
- CD5 = Medium compound
- Not approved for street or highway use
- Tube-type tire only

The Maxxis DTR-1 tire is specifically designed for dirt track racing and is available in multiple compound options. The tire's tread design can be customized to meet each rider's needs, providing superb traction and stability on any race track.

PART #	MFG #	POSITION	SIZE	LOAD SPEED RATING	OVERALL DIAMETER (IN)	MAX PSI	RIM SIZE (IN)	TREAD DEPTH (IN)
RIM SIZE (IN) 17								
844327	TM40022600	Front, Rear	120/70-17 CD5	58V TL	24	42	2.75X17	6/32*
RIM SIZE (IN) 19								
844330	TM88104100	Front, Rear	27.5X7.5-19 CD5	74H TT	27.6	36	3.50X19	9/32*
844329	TM88104200	Front, Rear	27.5X7.5-19 CD3	74H TT	27.6	36	3.50X19	9/32*

Designed and tested for intermediate-to-hard terrain in cooperation with 7X Supercross champion Jeremy McGrath, the Maxxcross MX-IH is the newest, most advanced tire in our MX lineup. The MX-IH's new tread pattern, compound and tire composition provide the stability, predictability and traction needed for the demands of harder terrain pro motocross and supercross racing.

- The all-new MX-IH is designed to perform on intermediate and hard terrain for everyone from weekend warriors to professional racers
- Improved construction provides a consistent, compliant feel under cornering, acceleration and braking, giving racers the confidence to charge into any corner
- Tread compound and pattern designed to provide extreme predictability in straight-line acceleration and braking zones



MFG #	POSITION	SIZE	LOAD SPEED RATING	OVERALL DIAMETER (IN)	MAX PSI	RIM SIZE (IN)	TREAD DEPTH (IN)	PART #
RIM SIZE (IN) 14								
TM00215600	Rear	90/100-14	49M TT	21.7	33	2.15x14	18	844364
RIM SIZE (IN) 16								
TM00214800	Rear	90/100-16	51M TT	23.6	33	2.15x16	18	844356
RIM SIZE (IN) 17								
TM00215700	Front	70/100-17	40M TT	22.9	33	1.60x17	14	844360
RIM SIZE (IN) 18								
TM00216200	Rear	120/90-18	65R TT	26.9	33	2.75x18	20	844354
TM00214700	Rear	110/100-18	64M TT	27.4	33	2.50x18	21	844357
TM00214900	Rear	110/100-18	64M TT	27.2	33	2.50x18	21	844362
RIM SIZE (IN) 19								
TM00215500	Front	70/100-19	42M TT	24.8	33	1.60x19	14	844352
TM00303500	Rear	120/80-19	63M TT	-	33	-	21	844353
TM00215300	Rear	120/90-19	66M TT	27.5	33	2.75x19	21	844355
TM00100000	Rear	110/90-19	62M TT	27.4	33	2.50x19	21	844358
TM00100300	Rear	110/90-19	62M TT	27.3	33	2.50x19	21	844361
TM00215000	Rear	120/80-19	63M TT	27.2	33	2.75x19	21	844363
TM00159200	Rear	100/90-19	57M TT	-	-	-	-	844365
TM00108800	Rear	110/90-19	62M TT	27.5	33	2.15x19	-	844366
RIM SIZE (IN) 21								
TM00099900	Front	80/100-21	51M TT	27.8	33	1.85x21	16	844351
TM00100200	Front	80/100-21	51M TT	27.8	33	1.85x21	16	844359



PIRELLI

Built for Every **Challenge**

The wide range of off-road motorcycle tyres in the Pirelli catalogue includes products offering top performance on any soft, medium or hard terrain, even in the harshest riding conditions.



OFFROAD

MT 21™ RALLYCROSS

MT 21™ RALLYCROSS

TRAIL AND ADVENTURE



- Developed for globetrotting motorcyclists and rally specialists who are looking for maximum flexibility of use, from the dunes of the desert to wide-ranging tourism on asphalt roads
- A flexible carcass to ensure high stability and precision in setting and following trajectories
- An optimised tread for use on dirt tracks and gravel, cross country racing and in the desert
- High performance off road and the blocks have greater resistance to tearing thanks to the specific compound
- Innovative carcass structure capable of supporting the bike's high speeds whilst ensuring high resistance to punctures

SIZES	LOAD/SPEED RATING	PART #
FRONT		
80/90-21	48P	747186
90/90-21	54R	747187

SIZE	LOAD/SPEED RATING	PART #
REAR		
120/90-17	64R	747188
130/90-17	68P	747189
110/80-18	58R	747190
120/80-18	62R	747191
120/90-18	65R	747192
130/90-18	69R	747193
140/80-18	70R	747194

MT 60™

MT 60™

TRAIL AND ADVENTURE



- Optimised for road use on Enduro bikes, at the same time it ensures excellent off road performance
- Reinforced carcass capable of ensuring comfort and stability even at full load
- Specific block layout to ensure maximum grip
- Excellent traction on all surfaces and in the most diverse weather conditions

SIZES	LOAD/SPEED RATING	PART #
FRONT		
100/90-19	57H	747135
90/90-19	52P	747136
90/90-21	54HMST	747137
90/90-21	54F (E)	747138

SIZES	LOAD/SPEED RATING	PART #
REAR		
120/90-17	64S	747139
120/90-17	64S(E)	747140
130/80-17	65HMST	747141
140/80-17	69HMST	747142



OFFROAD

SCORPION™ MT 90 A/T

SCORPION™ MT 90 A/T

▲ TRAIL AND ADVENTURE



- Flexibility of use on asphalt roads and on rough ground, with high levels of road holding and safety on all types of surface
- Tread with large central blocks for a more stable ride and V arrangement for the maximum grip in traction and braking
- Optimised carcass for best stability at high speeds even at full load
- Compound with balanced silica content capable of ensuring high mileage and better grip on both dry and wet surfaces

SIZES	LOAD/SPEED RATING	PART #
FRONT		
80/90-21	48S	747178
90/90-21	54S	747179
90/90-21	54V	747180

SIZES	LOAD/SPEED RATING	PART #
REAR		
120/90-17	64S	747181
110/80-18	58S	747182
120/80-18	62R	747183
140/80-18	70R	747184
150/80 R 18	70V	747185

SCORPION TRAIL II

SCORPION™ TRAIL II

▲ TRAIL AND ADVENTURE



- Suited to Enduro motorcycles with a Touring setup, capable of tackling long journeys and excursions with light off road stretches
- Sporty on the road, but capable of handling effectively even unsurfaced routes
- Revolutionary tread pattern which combines high performance with a contemporary and innovative design
- Technology with steel belt at 0° ensuring greater stability and excellent handling on all types of road surface, even at full load
- Compound with the latest generation components to enable the maximum traction in all weather conditions and the best possible ratio between performance and mileage

SIZES	LOAD/SPEED RATING	PART #
FRONT		
110/80 R 19	59V	747308
120/70 R 19	60V	747309
120/70 ZR 17	58W	747307
120/70 ZR 19	60W	747310
90/90 - 21	54V	747311

SIZES	LOAD/SPEED RATING	PART #
REAR		
130/80R17	65V	747312
140/80R17	69V	747313
150/70R17	69V	747314
150/70R18	70V	747322
160/60ZR17	(69W)	747315
170/60R17	72V	747316
170/60ZR17	72W	747317
180/55ZR17	(73W)	747320
190/55ZR17	(75W)	747321



SCORPION™ TRAIL III

A TRAIL AND ADVENTURE



- The sporty evolution of SCORPION™ TRAIL II
- Remarkable performance and handling for thrill lovers
- The wet grip of a sport touring tyre in a new adventure equipment
- Bi-Compound and full silica content on rear radial sizes
- New compounds and tread design ensures greater grip and stability

SIZES	LOAD/SPEED RATING	PART #
FRONT		
100/90-18	56V	747349
100/90-19	57V	747351
110/80R18	58V	747350
110/80R19	59V	747352
120/70R19	60V	747353
120/70ZR17	(58W)	747348
120/70ZR19	60W	747354
120/70ZR19	60W	747355
120/90-17	64H	747357
90/90V21	(54V)	747356

SIZES	LOAD/SPEED RATING	PART #
REAR		
130/80R17	65V	747358
140/80R17	69V	747359
150/70R17	69V	747360
150/70ZR18	70W	747366
160/60ZR17	(69W)	747361
170/60R	72V	747362
170/60ZR17	72W	747363
170/60ZR17	72W	747364
180/55ZR17	(73W)	747365

MT 60™ RS

MT 60™ RS

S ON-ROAD



High-performance radial equipment upgrading the road performance of knobby tyres.

- Specific radial carcass to ensure excellent handling
- Tread pattern optimized for use also on wet surfaces
- Special Superbike racing compound capable of maximizing grip and road holding for a pleasant riding sensation

SIZES	LOAD/SPEED RATING	PART #
FRONT		
130/90B16	67H	747143
110/70R17	54H	747144
120/70ZR17	58W	747145
110/80R18	58H	747146
120/70ZR18	59W	747147

SIZES	LOAD/SPEED RATING	PART #
REAR		
150/80B16	77H	747148
150/60R17	66H	747149
160/60R17	69H	747150
180/55R17	73H	747151
180/55ZR17	73W	747152
180/55ZR17	73W	747153



OFFROAD

MT 16™ GARACROSS



MT 16™ GARACROSS

OFF-ROAD RACING

- All-around tyre with great durability, high level of grip, even when worn
- Rear works excellent with Scorpion Pro front for woods use or with Scorpion XCMH front for harder/rocky terrain and woods use

SIZES	LOAD/SPEED RATING	PART #
FRONT		
80/100-21	51M	747234

SIZES	LOAD/SPEED RATING	PART #
REAR		
110/100-18	64	747235
120/100-18	59	747236

MT 43™ PRO TRIAL



MT 43™ PRO TRIAL

OFF-ROAD RACING

- Reinforced carcass to provide high resistance combined with a long life
- Specific construction capable of reducing deformation during use ensuring the maximum contact area in all road surface conditions
- High performance on hard, dry and damp surfaces, plus excellent for indoor competition use

SIZES	LOAD/SPEED RATING	PART #
FRONT		
2.75-21	54P	747237

SIZES	LOAD/SPEED RATING	PART #
REAR		
400-18	64P	747238



SCORPION™ MX SOFT

OFF-ROAD RACING



- Effective in all conditions of use: competition, training or just for fun!
- Excellent traction and self-cleaning properties enable top speeds right from the start of the race
- Specific carcass capable of maintaining effective and reliable performance on soft surfaces from the gate drop to the checkered flag
- Rear tire blocks with blade layout for the maximum traction in mud and sand
- The tread pattern and compound were developed with the contribution of the most prestigious players in motocross and supercross

SIZES	LOAD/SPEED RATING	PART #
REAR		
80/100-12	50M	747195
90/100-16	51M	747196
100/90-19	57M	747197

SIZES	LOAD/SPEED RATING	PART #
REAR		
110/90-19	62M	747198
120/90-18	65M	747199

SCORPION™ MX32™ MID SOFT

SCORPION™ MX32™ MID SOFT

OFF-ROAD RACING



- Effective in all use conditions: competition, training or just for fun!
- Excellent traction to guarantee the maximum power transmission to the ground
- Block arrangement optimised to improve braking stability and cornering side-grip
- Front lateral knobs guarantee greater line-holding precision in corners
- Performance reliability even in extreme conditions
- The tread pattern and compound were developed with the contribution of the most prestigious players in MX competitions

SIZES	LOAD/SPEED RATING	PART #
FRONT		
80/100-21M/C	51M	747344
2.5-10	33J	747200
60/100-12	36M	747201
60/100-14	29M	747202
70/100-17	40M	747203
2.5-11	42M	747204
60/100-18	57M	747206

SIZES	LOAD/SPEED RATING	PART #
REAR		
110/90-19	62M	747345
120/80-19	63M	747346
120/90-19	66M	747347
2.75-10	37J	747207
80/100-12	50M	747208
90/100-14	49M	747209
90/100-16	51M	747210
100/90-19	57M	747211



OFFROAD

SCORPION™ MX 32™ MID HARD

SCORPION™ MX32™ MID HARD

OFF-ROAD RACING



- Tread pattern born to offer the best performances on mid-hard surfaces with an excellent traction even on increasingly severe terrain conditions during the race
- A totally new rear tread pattern advances the Mid Hard 454's performances; each block contributing to an improved traction and power transmission
- Optimal resiliency for consistent performance over time
- Dedicated compound for outstanding grip in lateral sliding control
- Block links (or "bridges") layout for tear resistance
- Tread pattern and compounds proven with the most prestigious competitors in MX World Championship

SIZES	LOAD/SPEED RATING	PART #
FRONT		
80/100-21	51M	747215
90/100-21	57M	747216

SIZES	LOAD/SPEED RATING	PART #
REAR		
70/100-19	42M	747217
90/100-16	51M	747218
100/90-19	57M	747219
110/90-19	62M	747220
120/80-19	63M	747221

SCORPION™ MX EXTRA X

SCORPION™ MX EXTRA X

OFF-ROAD RACING



- Grip and traction on a wide range of terrain (from mid soft to mid hard)
- Perfect application for training; optimal compromise between performance and durability
- Tread pattern taken from previous design with the rear's layout rigidity improved through "bridges" and a new front similar to the Scorpion MX Soft 410
- Multi-ply carcass with high resistance to punctures but maximum flexibility to absorb forces during jumps or obstacles
- Training performance in all terrain conditions with uniform block wear, resistance to deformation while damping and thus an extended durability

SIZES	LOAD/SPEED RATING	PART #
FRONT		
80/100-21	51M	747222

SIZES	LOAD/SPEED RATING	PART #
REAR		
100/90-19	57M	747223
110/90-19	62M	747224
120/80-19	66M	747225



SCORPION™ XC MID SOFT

OFF-ROAD RACING



- Specifically for use on Enduro motorcycles in cross-country configurations
- Excellent for routes with jumps, in the mud and through vegetation
- Polyester carcass with controlled deformation to ensure an ample footprint for maximum effectiveness of traction and braking
- Optimised grip and steering precision thanks to small rigid blocks on the front tyre
- Racing compound with high performance during the entire competition, independent of the conditions of the surface
- Carcass and pattern evolved from the experience of the world motocross championship

SIZES	LOAD/SPEED RATING	PART #
FRONT		
80/100-21	51M	747226

SIZE	LOAD/SPEED RATING	PART #
REAR		
110/100-18	64M	747227
120/100-18	68M	747228

SCORPION™ XC MID HARD

SCORPION™ XC MID HARD

OFF-ROAD RACING



- Specifically for use on enduro motorcycles in professional cross-country configurations
- Excellent for routes with jumps, in the mud, through vegetation or at least on usually inaccessible routes
- Specific off road compound to ensure constant cross-country performance
- Carcass and pattern evolved from motocross experience made available to cross country adventure riding
- A Heavy Duty street legal product

SIZES	LOAD/SPEED RATING	PART #
FRONT		
80/100-21	51M	747229

SIZE	LOAD/SPEED RATING	PART #
REAR		
100/100-18	51R	747230
110/100-18	64M	747231
120/100-18	68M	747232
140/80-18	70M	747233
110/100-18M/C	64M MST	747328



OFFROAD

MID-SOFT STADIUM

MID-SOFT STADIUM



- Optimal Performance: Designed for soft and intermediate terrain, ensuring superior grip and handling in challenging conditions.
- Mid-Soft Compound: Provides exceptional traction and stability, allowing you to maintain control during extreme racing and off-road adventures.
- Advanced Tread Pattern: Enhances traction while minimizing wear, making it ideal for both competitive riders and casual weekend warriors.
- Durability: Engineered to withstand rugged conditions, ensuring long-lasting performance and reliability on various terrains.

SIZES	LOAD/SPEED RATING	PART #
FRONT		
80/100-21 MST	51M	747323

SIZE	LOAD/SPEED RATING	PART #
REAR		
120/80-19 NHS	63M	747326
120/90-19 NHS	66M	747327

MID-HARD STADIUM

MID-HARD STADIUM



the PIRELLI MID-HARD STADIUM 80/100-21 M/C 51M MST tire, expertly engineered for hard terrain riding. This tire features a mid-hard compound that provides exceptional durability and grip, allowing you to tackle rocky paths and hard-packed surfaces with confidence. Designed for both competitive and recreational dirt bike riders, the advanced tread pattern enhances traction and stability, ensuring optimal handling in various conditions. Whether you're racing or exploring the trails, this tire offers the reliability you need to push your limits. As a special bonus, each purchase includes a stylish keychain, perfect for showcasing your passion for quality off-road gear. Upgrade your dirt bike setup today with the PIRELLI MID-HARD STADIUM tire and experience the difference in performance and control!

SIZES	LOAD/SPEED RATING	PART #
FRONT		
80/100-21 M/C	51M	747324

SIZES	LOAD/SPEED RATING	PART #
REAR		
110/90-19 NHS	65V	747325



ADVENTOURING SIZES



RALLY RACING SET

SCORPION™ RALLY

OFF-ROAD RACING

- 2 road legal off-road ranges in 1: the Adventouring sizes complement the Rally Racing set
- Outstanding off-road compound resistance with high overall performance even during intensive use
- Rear traction granted even on demanding surfaces
- Adventouring sizes
- Tread pattern enables incredible performance - wherever your adventure takes you, both off and on road
- Carcass structure blends road handling and off-the road puncture resistance
- Rally Racing set
- Front tread design and rear structure (with 0° steel belt) optimised for extreme directional stability at high speed
- Tread knobs ensure top off-road handling and traction over bottomless dunes

SIZES	LOAD/SPEED RATING	PART #
FRONT		
110/80R19	59R	747170
120/70R19	60T	747171
90/90-21	54R	747172
90/90-21	54RMSTRACE	747173

SIZES	LOAD/SPEED RATING	PART #
REAR		
150/70R17	69V	747174
170/60R17	72V	747175
140/80-18	70RMSTRACE	747176
150/70R18	70V	747177

SCORPION™ RALLY STR

SCORPION™ RALLY STR

OFF-ROAD RACING



Rally-ready tire with strong on-road performance. Silica-rich compound delivers superior dry/wet grip, stability, and abrasion resistance. Wider, longer blocks and reduced knob spacing create a larger contact patch for better stability without losing off-road traction. Heat is evenly dispersed to prevent knob tearing at high speeds.

SIZES	LOAD/SPEED RATING	PART #
FRONT		
110/70R17	54H	747154
120/70R17	58V	747155
110/80R18	58H	747156
120/70R18	59V	747157
100/90-19	57V	747158
110/80R19	59H	747159
110/80R19	59V	747160
120/70R19	60V	747161
90/90-21	54V	747162

SIZES	LOAD/SPEED RATING	PART #
REAR		
130/80R17	65V	747163
140/80R17	69V	747164
150/60R17	66H	747165
150/70R17	69V	747166
170/60R17	72V	747167
180/55R17	73V	747168
150/70R18	70V	747169



D.I.D.[®]

TSUYOI 強 **D.I.D.** *DIRTSTAR/ST-X*
STRONG MX RIM



DIRTSTAR ST-X 16X1.85

A high quality and strong rim option for KTM, Yamaha, Surron, and Talaria bikes alike.

40% stronger than typical OE rims, the ST-X series rim has the highest rigidity rate and strength to withstand great forces and refrain from deformation. Utilized in many disciplines of racing by top-level factory teams and athletes.

DESCRIPTION	MFG #	PART #
STX BLACK KTM	16X185STB01T	338692
V BLACK YAMAHA	16X185VB01Y	338693
V SILVER YAMAHA	16X185VS01Y	338694



ORIGINAL DIRTSTAR

Long-lasting, race-ready, and engineered for performance, the Original DirtStar rim delivers a smart upgrade for riders demanding more than stock equipment. If you're pushing your bike hard, don't let your rim be the weak link.

DESCRIPTION	MFG #	PART #
RIM 17X3.50 MOTARD BLACK	17X350E6B01T	338695
RIM 17X5.00 MOTARD BLACK	17X500E6B01X	338696

ORIGINAL DIRTSTAR 18X2.15

A 20% strength increase from the typical OEM rims, the Original DirtStar line is a solid upgrade.

DESCRIPTION	MFG #	PART #
LTX BLACK HONDA	18X215LTB01H	338697
LTX BLACK KTM	18X215LTB01T	338698
STX BLACK HONDA	18X215STB01H	338699
STX BLACK KAWASKI	18X215STB01K	338700
STX BLACK KTM	18X215STB01T	338701
STX BLACK YAMAHA	18X215STB01Y	338702
STX BLUE YAMAHA	18X215STBU1Y	338703
STX RED HONDA	18X215STR01H	338704
V BLACK HONDA	18X215VB01H	338705
V BLACK KAWASAKI	18X215VB01K	338706
V BLACK SUZUKI	18X215VB01S	338707
V BLACK KTM	18X215VB01T	338708
V BLACK YAMAHA	18X215VB01Y	338709
V SILVER HONDA	18X215VS01H	338710
V SILVER KAWASAKI	18X215VS01K	338711
V SILVER SUZUKI	18X215VS01S	338712
V SILVER KTM	18X215VS01T	338713
V SILVER YAMAHA	18X215VS01Y	338714



MX WHEELS



ORIGINAL DIRTSTAR 18X2.50

The DID DirtStar 18×2.50 Rear Rim is a high-strength, lightweight aluminum rim designed for off-road performance. Made in Japan from 7-series alloy, it offers 20% more strength than OEM rims and is trusted by pro racers for motocross, enduro, and trail use. Available in black or silver with OEM-compatible drilling.

DESCRIPTION	MFG #	PART #
E6 BLACK KTM	18X250E6B01T	338715
E6 SILVER KTM	18X250E6S01T	338716



DIRTSTAR ST-X 19X1.40

A high quality and strong rim option for KTM, Yamaha, Surron, and Talaria bikes alike.

DESCRIPTION	MFG #	PART #
STX BLACK KTM	19X140STB01T	338717
V BLACK YAMAHA	19X140VB01Y	338718
V SILVER YAMAHA	19X140VS01Y	338719

ORIGINAL DIRTSTAR 19X1.85

A 20% strength increase from the typical OEM rims, the Original DirtStar line is a solid upgrade.



DESCRIPTION	MFG #	PART #	DESCRIPTION	MFG #	PART #
LTX BLACK HONDA	19X185LTB01H	338720	STX SILVER YAMAHA	19X185STS01Y	338733
LTX BLACK KAWASAKI	19X185LTB01K	338721	STX YELLOW SUZUKI	19X185STY01S	338734
LTX BLACK SUZUKI	19X185LTB01S	338722	V BLACK HONDA	19X185VB01H	338735
LTX BLACK YAMAHA	19X185LTB01Y	338723	V BLACK KAWASAKI	19X185VB01K	338736
LTX SILVER HONDA	19X185LTS01H	338724	V BLACK SUZUKI	19X185VB01S	338737
LTX SILVER KAWASAKI	19X185LTS01K	338725	V BLACK YAMAHA	19X185VB01Y	338738
LTX SILVER SUZUKI	19X185LTS01S	338726	V SILVER HONDA	19X185VS01H	338739
LTX SILVER YAMAHA	19X185LTS01Y	338727	V SILVER KAWASAKI	19X185VS01K	338740
STX BLACK HONDA	19X185STB01H	338728	V SILVER SUZUKI	19X185VS01S	338741
STX BLACK KAWASAKI	19X185STB01K	338729	V SILVER YAMAHA	19X185VS01Y	338742
STX BLACK SUZUKI	19X185STB01S	338730			
STX BLACK YAMAHA	19X185STB01Y	338731			
STX SILVER KAWASAKI	19X185STS01K	338732			

ORIGINAL DIRTSTAR 19X2.15

A great OEM replacement rim that is 20% stronger than the typical OEM rim.



DESCRIPTION	MFG #	PART #	DESCRIPTION	MFG #	PART #
LTX BLACK HONDA	19X215LTB01H	338743	STX SILVER KAWASAKI 1	19X215STS01K	338762
LTX BLACK KAWASAKI	19X215LTB01K	338744	STX SILVER YAMAHA 1	19X215STS01Y	338763
LTX BLACK SUZUKI	19X215LTB01S	338745	STX YELLOW SUZUKI	19X215STY01S	338764
LTX BLACK KTM	19X215LTB01T	338746	V BLACK HONDA	19X215VB01H	338765
LTX BLACK YAMAHA	19X215LTB01Y	338747	V BLACK KAWASAKI	19X215VB01K	338766
LTX SILVER HONDA	19X215LTS01H	338748	V BLACK SUZUKI	19X215VB01S	338767
LTX SILVER KAWASAKI	19X215LTS01K	338749	V BLACK KTM	19X215VB01T	338768
LTX SILVER SUZUKI	19X215LTS01S	338750	V BLACK YAMAHA	19X215VB01Y	338769
LTX SILVER KTM	19X215LTS01T	338751	V SILVER HONDA	19X215VS01H	338770
LTX SILVER YAMAHA	19X215LTS01Y	338752	V SILVER KAWASAKI	19X215VS01K	338771
STX BLACK HONDA	19X215STB01H	338753	V SILVER SUZUKI	19X215VS01S	338772
STX BLACK KAWASAKI	19X215STB01K	338754	V SILVER KTM	19X215VS01T	338773
STX BLACK SUZUKI	19X215STB01S	338755	V SILVER YAMAHA	19X215VS01Y	338774
STX BLACK KTM	19X215STB01T	338756			
STX BLACK YAMAHA	19X215STB01Y	338757			
STX BLUE YAMAHA	19X215STBU1Y	338758			
STX GOLD HONDA	19X215STG01H	338759			
STX GOLD KTM	19X215STG01T	338760			
STX RED HONDA	19X215STR01H	338761			

ORIGINAL DIRTSTAR 19X2.50

A 20% strength increase from the typical OEM rims, the Original DirtStar line is a solid upgrade for your motorcycle.



DESCRIPTION	MFG #	PART #
E6 BLACK HONDA	19X250E6B01H	338775
E6 BLACK YAMAHA 1	19X250E6B01Y	338776
E6 SILVER YAMAHA 1	19X250E6S01Y	338777

ORIGINAL DIRTSTAR 21X1.85

A great OEM replacement rim that is 20% stronger than the typical OEM rim. Upgrade with D.I.D today!



DESCRIPTION	MFG #	PART #
E6 BLACK KTM 1	21X185E6B01T	338810
E6 SILVER KTM 1	21X185E6S01T	338811

DIRTSTAR ST-X 21X1.60

40% stronger than typical OE rims, the ST-X series rim has the highest rigidity rate and strength to withstand great forces and refrain from deformation. Utilized in SX/MX, GNCC, Rally, and many other disciplines of racing by top-level factory teams and riders.



DESCRIPTION	MFG #	PART #
LTX BLACK HONDA	21X160LTB01H	338778
LTX BLACK KAWASAKI	21X160LTB01K	338779
LTX BLACK SUZUKI	21X160LTB01S	338780
LTX BLACK KTM	21X160LTB01T	338781
LTX BLACK YAMAHA	21X160LTB01Y	338782
LTX SILVER HONDA	21X160LTS01H	338783
LTX SILVER KAWASAKI	21X160LTS01K	338784
LTX SILVER SUZUKI	21X160LTS01S	338785
LTX SILVER KTM	21X160LTS01T	338786
LTX SILVER YAMAHA	21X160LTS01Y	338787
STX BLACK HONDA	21X160STB01H	338788
STX BLACK KAWASAKI	21X160STB01K	338789
STX BLACK SUZUKI	21X160STB01S	338790
STX BLACK KTM	21X160STB01T	338791
STX BLACK YAMAHA	21X160STB01Y	338792
STX BLUE YAMAHA	21X160STBU1Y	338793
STX GOLD HONDA	21X160STG01H	338794
STX GOLD KTM	21X160STG01T	338795
STX RED HONDA	21X160STR01H	338796
STX SILVER HONDA	21X160STS01H	338797
STX SILVER YAMAHA 1	21X160STS01Y	338798
STX YELLOW SUZUKI	21X160STY01S	338799
V BLACK HONDA	21X160VB01H	338800
V BLACK KAWASAKI	21X160VB01K	338801
V BLACK SUZUKI	21X160VB01S	338802
V BLACK KTM	21X160VB01T	338803
V BLACK YAMAHA	21X160VB01Y	338804
V SILVER HONDA	21X160VS01H	338805
V SILVER KAWASAKI	21X160VS01K	338806
V SILVER SUZUKI	21X160VS01S	338807
V SILVER KTM	21X160VS01T	338808
V SILVER YAMAHA	21X160VS01Y	338809



D.I.D.[®]

FAST SAME DAY SHIPPING

TIRES & TRACKS

TUBES

CHEMICALS

TOOLS

BATTERIES

FUEL & INTAKE

AIR & OIL FILTERS

ATV/UTV

TABLE OF CONTENTS

GBC	105-107
ITP	108-125
KENDA	126-133
MAXXIS	134-141
RACELINE	142-153



MONGREL

The MONGREL is built specifically for today's side-by-side vehicles that feature greater horsepower and speed capabilities.

- Aggressive tread for superior traction
- 10-PLY Rated construction for enhanced durability
- Reinforced sidewall for greater puncture resistance
- Tread designed for all types of terrain
- Original light-truck-style UTV tire and trusted for over 10+ years

SIZES	WEIGHT		PLY	LOAD RATING	PART #
25X8.00R12	23.8	Radial	10PR	600	847037
28X10.00R15	29.6	Radial	10PR	825	847045



KANATI TERRA MASTER

The Terra Master's profile is optimized for fierce straight-line traction and its side bite gives you greater cornering control.

- Asymmetrical tread pattern for dual tire benefits and performance characteristics
- Steel-belted radial design for a stronger core and greater wear resistance
- 10-Ply Rated construction provides enhanced durability
- Non-directional tread pattern gives you excellent responsiveness in any direction

SIZES	WEIGHT		PLY	LOAD RATING	PART #
AT27X11R12	31	Radial	10PR	855	847075
AT27X9R14	29	Radial	10PR	715	847078
AT27X10R14	29.5	Radial	10PR	785	847074
AT28X10R14	31.2	Radial	10PR	855	847079
AT30X10R14	35.4	Radial	10PR	935	847081
AT32X10R14	41.2	Radial	10PR	990	847085
AT30X10R15	35.4	Radial	10PR	910	847082
AT31X10R14	37.2	Radial	10PR	990	847083
AT31X10R15	37	Radial	10PR	990	847084
AT32X10R15	39.8	Radial	10PR	1050	847086
AT33X10R15	41.2	Radial	10PR	1140	847087
AT35X10R15	47	Radial	10PR	1235	847088





KANATI MINI MONGREL

The GBC Mini Mongrel is the industry's first YOUTH SXS specific tire. It features the same tread pattern as the larger and dependable Kanati Mongrel, only sized to accommodate smaller machines and younger drivers. Whether its race weekend or family time on the trails, the Mini Mongrel's tread pattern makes it perfect for youth SxS with its low rolling resistance yet aggressive tread for optimum traction. Now the whole family has access to high-quality performance tires that can handle a wide variety of terrains with the same durability and dependability you expect from the Mongrel name.

- Narrower front engineered for optimal handling
- Rear sizes offer a wider contact patch for improved drive and braking power
- Aggressive tread for maximum traction on a variety of terrains

SIZES	WEIGHT	PLY	MAX LOAD	PART #
23X7.00R10	16.4	6PR	275	847050
23X8.00R10	17.7	6PR	310	847051



DIRT COMMANDER

A super-tough, puncture-resistant 8-ply rated bias tire. The deep siped tread design offers superior traction that allows the Dirt Commander to tear into rocks, mud, dirt, creek beds, grass, hills, and steep rock ledges.

- Asymmetrical tread pattern for dual tire benefits and performance characteristics
- Super tough and puncture resistant
- 8 ply rated bias construction
- Deep sipes for greater traction
- Biting edges for greater stability and control

SIZES	WEIGHT		PLY	LOAD RATING	PART #
26X11.00-12	27.1	Bias	8PR	480/680	847008
26X11.00-14	28.2	Bias	8PR	730/1045	847009
30X10.00-15	38	Bias	8PR	890	847020



DIRT COMMANDER 2.0

The All-New Dirt Commander 2.0 is GBC's newest SXS tire that features a bold redesign of the popular Dirt Commander. The 2.0 showcases a strong square shoulder profile that maintains grip and bite even during extreme speeds and cornering. Plus, the sidewall protection is even greater than before courtesy of the elongated sidewall lugs, which enable you to power through tight paths and obstacles with confidence. The flatter profile across the tread face allows maximum acceleration and braking power, even in the most challenging conditions. GBC also redesigned the tread blocks for easier clean-out and added deeper sipes for greater tread flex. The Dirt Commander 2.0 is ready to take on all kinds of adventures, from rocky trails and desert driving to soft and intermediate terrains.



- It's time to take your ride to the next level with the Dirt Commander 2.0!
- Radial construction provides a smoother ride
- Strategically placed lugs for exceptional grip in all types of terrain
- Square shoulder profile for maximum acceleration and braking power
- Long side lug for enhanced sidewall protection



SIZES	PLY RATING	T/D 32ND IN.	OD	SW	RIM WIDTH	WEIGHT	PSI	MAX LOAD	PART #
28X10.00R14	8PR/LRD	23	27.7 on 7.0	8.9	6.5	36.6	32	1050	847128
29X11.00R14	8PR/LRD	22	29.5 on 8.0	10.7	8	34.1	35	1480	847130
32X10.00R15	8PR/LRD	23	31.7 on 7.0	9.6	7	38.3	35	1430	847132
33X10.00R15	8PR/LRD	23	32.7 on 7.0	9.6	7	43.1	35	1520	847133
35X10.00R15	8PR/LRD	23	34.7 on 7.0	9.9	7	47.5	35	1735	847134

DIRT DEVIL

The GBC Dirt Devil is Greenball's top selling ATV/UTV tire of all time. Backed by over 20 years of proven performance, the Dirt Devil is well suited for all types of terrain. It can handle dirt, gravel, hard pack and light mud with ease. It has a deep V-type tread that digs in terrains, but yet the ride is still smooth and comfortable. This tire fits a wide range of ATVs and other utility vehicles used in industrial, farm, hunting, parks and recreation, and other service industries.



- Economical upgrade
- Great traction in various terrains
- Wide range of popular sizes



SIZES	WEIGHT		PLY	LOAD RATING	PART #
27X12.00-12	32.1	Bias	6PR	550	847126



SINCE 1982

CONQUERING

THE WORLD'S

MOST CHALLENGING TERRAINS



HOLESHOT

One of the most-copied ATV tires ever - often imitated, never duplicated - Don't settle for less than the original

- Patented split-knob design make this one of the best-performing knobbies around
- Best value Holeshot tire available - more traction for less money

SPECIFICATIONS				
SIZES	PLY	WEIGHT	MFG #	PART #
20x11-8	4	14.3	532031	262001
20x11-9	4	16.1	532032	262002
20x11-10	4	15.1	532035	262003
21x7-10	2	11	532040	262000



HOLESHOT MXR6

An ideal choice for loose track surfaces, with wider-spaced split knobs for better bite and clean-out

- Front MXR6 features a new, longer-wearing tread compound - more motos per tire
- Rear MXR6 uses a new reinforced carcass; minimizes stretching while maintaining a flat profile, providing consistent feel and performance

SPECIFICATIONS				
SIZES	PLY	WEIGHT	MFG #	PART #
20x6-10	2	9	532021	262005
18X10-8	2	12.3	532023	262006
18x10-9	2	10.4	532024	262007



HOLESHOT XC

Dollar for dollar, the single best handling improvement you can make on any sport quad

- Most puncture-resistant sport tire on the market today.
- Ideal for desert riding and racing
- An industry standard, this tire has enjoyed a long, winning history

SPECIFICATIONS				
SIZES	PLY	WEIGHT	MFG #	PART #
20x11-9	6	16.4	532034	262021
22x7-10	4	13.2	532045	262020



ITP TIRES & WHEELS



HOLESHOT XCR

Ideal for today's 4-stroke sport machines!

- 6-ply tough yet light in weight
- Lower in profile, narrower and lighter than our XC/XCT models
- Special angled shoulder knob design provides increased side bite for faster, more controllable cornering.
- Bright hot patch logo on sidewall

SPECIFICATIONS				
SIZES	PLY	WEIGHT	MFG #	PART #
21x7-10	6	12	532009	262022
20x11-9	6	16.5	532054	262024



HOLESHOT GNCC

The Ultimate Trail Riding and GNCC Racing tire

- Steers Light, Tracks straight and rides smooth
- Exceptional grip, balanced cornering and unbeatable clean-out
- Long wearing and highly puncture resistant

SPECIFICATIONS				
SIZES	PLY	WEIGHT	MFG #	PART #
21x7-10	6	12	532029	262025
20x10-9	6	13.8	532025	262027



HOLESHOT ATR

- Radial tire technology offers amazingly smooth ride quality - flexible sidewalls absorb trail shock
- Super strong carcass tracks straight and offers unmatched cornering control

SPECIFICATIONS				
SIZES	PLY	WEIGHT	MFG #	PART #
25x10x12	6	21	532067	262036
25x8x12	6	18	532070	262035



HOLESHOT XCT

Our tallest high-performance trail riding and racing knobby

- Aggressive tread pattern for even more precise cornering ability
- Perfect for rough, rocky desert terrain
- Extremely puncture resistant thanks to extra heavy-duty sidewall construction
- The Baja dominator! Winner of three straight SCORE Baja 1000 events; in 2005 Team Alba Pro rode to the win without a single flat

SPECIFICATIONS				
SIZES	PLY	WEIGHT	MFG #	PART #
22x11-9	6	18.5	532038	262032
22x11-10	6	14	537051	262033
23x7-10	4	14	537047	262031



HOLESHOT HD

The roughest, toughest Holeshot tire ever

- Wide stance helps to climb out and stay out of ruts
- Stepped shoulder knob design offers exceptional side bite and rut control
- Special focus on the sidewall has resulted in unmatched puncture resistance

SPECIFICATIONS				
SIZES	PLY	WEIGHT	MFG #	PART #
22x7-10	6	13	532011	262029
20x11-9	6	19.5	532012	262030





ITP TIRES & WHEELS



MUD LITE SP

Surprisingly light, reducing unsprung weight and allowing that high-tech suspension to maintain its maximum effectiveness

- 3/4-in lug
- Sized for use on most late-model, high-performance sport ATVs

SPECIFICATIONS				
SIZES	PLY	WEIGHT	MFG #	PART #
20x11-9	6	16.7	560428	262041
22x7-10	6	13.5	560429	262042



MUD LITE II

A new twist on a proven classic, for SxSs

- Redesigned tread pattern provides better traction, improves mud clean-out and maximizes ride comfort
- Improved shoulder protection, mud breaking lugs and stabilizing cords to reduce flex
- Available in sizes 25-30-inches tall, on 12 and 14-inch rims

SPECIFICATIONS				
SIZES	PLY	WEIGHT	MFG #	PART #
25X8-12	6	22.1	6P0527	262185
25X10-12	6	25.8	6P0528	262186
26X9-12	6	28.7	6P0529	262187
26X11-12	6	34.3	6P0530	262188
27X9-12	6	29.2	6P0525	262189
27X11-12	6	35.8	6P0526	262190
23X8-12	6	17.9	6P0886	262217

SPECIFICATIONS				
SIZES	PLY	WEIGHT	MFG #	PART #
25X8-12	6	28.4	6P0531	262191
25X10-12	6	32.6	6P0532	262192
26X9-12	6	34.1	6P0533	262193
26X11-12	6	37.6	6P0534	262194
27X9-12	6	37.3	6P0523	262195
27X11-12	6	42.6	6P0524	262196
23X8-12	6	20.8	6P0887	262218



MUD LITE XL

Priced right - You won't find a tire that's lighter, tougher or more capable at such a reasonable price

- 1 1/8-in. lug
- Extended-wear rubber compound for even longer life and better value
- Revolutionary all-conditions tire: it's a 6-ply mud tire that's designed for the trail, a trail tire that slings mud with the best of them
- Unique center tread contact area provides a smooth, radial-like ride

SPECIFICATIONS				
SIZES	PLY	WEIGHT	MFG #	PART #
27X10-12	6	29	56A345	262070
27X12-12	6	32.9	56A347	262071
27X10-14	6	29.2	560455	262072
27X12-14	6	32	560456	262073
28X10-12	6	28.5	56A349	262074
28X12-12	6	31.2	56A350	262075
28X10-14	6	28.7	560494	262076
28X12-14	6	31.6	560495	262077

SPECIFICATIONS				
SIZES	PLY	WEIGHT	MFG #	PART #
25X12-11	6	27.8	560431	262062
25X8-12	6	20.9	560363	262063
25X10-12	6	28.4	560364	262064
25X12-12	6	26.4	560432	262065
26X9-12	6	24.3	56A3P6	262066
26X10-12	6	27.1	56A343	262067
26X12-12	6	32.9	56A361	262068
27X9-12	6	26.5	56A380	262069



MUD LITE XXL

The biggest, baddest mud/trail tire in the ITP lineup

- Its taller profile and super-aggressive 1.3-inch-deep lugs make this an extreme tire for extreme machines in the most extreme conditions
- Surprisingly light compared to any product anywhere close to this tire
- Best for highly modified, big-bore 4x4 ATVs operating primarily in muddy conditions



SPECIFICATIONS				
SIZES	PLY	WEIGHT	MFG #	PART #
30x10-12	6	33	560401	262078
30x12-12	6	37.1	560419	262079
30x10-14	6	34.2	560462	262080
30x12-14	6	37.5	560463	262081

MUD LITE AT

The Mud Lite is priced right - Shop and compare - you won't find a tire that's lighter, tougher or more capable at such a reasonable price

- 3/4-in. lug
- Extended-wear rubber compound for even longer life and better value
- Revolutionary all-conditions tire: it's a 6-ply mud tire that's designed for the trail, a trail tire that slings mud with the best of them
- Unique center tread contact area provides a smooth, radial-like ride



SPECIFICATIONS				
SIZES	PLY	WEIGHT	MFG #	PART #
22x11-8	6	16.5	56A387	262043
22x11-9	6	16.9	56A388	262044
25x12-9	6	23.7	56A373	262045
22x8-10	6	14.2	56A3A8	262046
22x11-10	6	18	56A3A5	262047
23x8-10	6	13.5	56A326	262048
23x10-10	6	17.2	56A327	262049
24x11-10	6	19.9	56A305	262050
25x11-10	6	19.8	56A308	262051

SPECIFICATIONS				
SIZES	PLY	WEIGHT	MFG #	PART #
23x8-11	6	15.9	56A304	262053
24x8-11	6	14.5	56A332	262054
24x9-11	6	17.6	56A3A9	262055
24x10-11	6	19.4	56A328	262056
25x8-11	6	16.8	56A320	262057
25x10-11	6	18.6	56A322	262058
24x8-12	6	16.2	560430	262059
25x8-12	6	16.9	56A306	262060
25x10-12	6	22.4	56A321	262061

MUD LITE XTR

The industry's first Extreme Terrain RADIAL tire

- Super-aggressive tread design features 11/8-in. deep, angled, grooved lugs to achieve an exceptional level of traction
- Long-wearing tread compound
- The 12-inch option is ideal for primarily muddy conditions, offering better flex and more flotation
- The revolutionary 14-inch model is an excellent all around trail/mud choice, with lower-profile sidewall resulting in reduced flex and a dramatic improvement in handling and rider confidence



SPECIFICATIONS				
SIZES	PLY	WEIGHT	MFG #	PART #
25x8R-12	6	22	560398	262082
25x10R-12	6	27	560399	262083
26x9R-12	6	27	560387	262084
26x11R-12	6	32	560388	262085

SPECIFICATIONS				
SIZES	PLY	WEIGHT	MFG #	PART #
27x9R-12	6	29	560378	262086
27x11R-12	6	34	560379	262087
27x9R-14	6	29	560373	262088
27x11R-14	6	35	560372	262089



ITP TIRES & WHEELS



TERRA-HOOK

- Balanced tread-to-void ratio ensures a smooth ride on harder surfaces
- Alternating shoulder elements assist grip from any angle of approach or direction and enhance forward or reverse motion in rutted conditions
- Unique tread blocks with alternating pitches provide true multi-surface, multi-condition traction
- 3/4-inch lug depth for maximum handling and control
- Tread block channels allow the tread to flex giving consistent traction over roots, rocks and other trail conditions
- Supreme traction on lush trails and soft terrain

SPECIFICATIONS				
SIZES	PLY	WEIGHT	MFG #	PART #
35x10R-15	8	22	6P1985	264089
26x9R-12	8	29.9	6P0939	262227
26x11R-12	8	32.4	6P0940	262228
27x9R-14	8	32.8	6P0941	262229
27x11R-14	8	35.2	6P0942	262230

SPECIFICATIONS				
SIZES	PLY	WEIGHT	MFG #	PART #
28x9R-14	8	33.5	6P0943	262231
28x11R-14	8	36	6P0944	262232
30x10R-14	8	35.5	6P0945	262233
32x10R-14	8	38.6	6P0946	262234
32x10R-15	8	38.1	6P0947	262235

MEGA MAYHEM

Same winning features and benefits of the original Mayhem

- Ultra-deep 1.5-inch tread depth
- 6 ply rated for added puncture resistance
- Tread pattern delivers surprisingly smooth ride on hard pack surfaces



SPECIFICATIONS				
SIZES	PLY	WEIGHT	MFG #	PART #
27x9-12	6	30.1	6P0035	262098
27x11-12	6	33.7	6P0037	262099
27x9-14	6	27.5	6P0032	262100
27x11-14	6	33.1	6P0033	262101
28x9-12	6	32.8	6P0051	262102
28x11-12	6	34.4	6P0043	262103
28x9-14	6	30.4	6P0052	262104
28x11-14	6	33.5	6P0044	262105



MAMMOTH MAYHEM

Incredibly smooth ride

- Mammoth 2 inch lug depth
- Extended wear compound
- 6 ply rated for added puncture resistance

**MAMMOTH
MAYHEM**

SPECIFICATIONS				
SIZE	PLY	WEIGHT	MFG #	PART #
32x10-14	6	54	6P0198	262108



ULTRA CROSS R SPEC RACE

You can feel confident riding the Ultra Cross R Spec Race tires during extreme desert racing. With an 8-ply radial construction made from ITP's "Tough Tread" rubber compound, these racing tires provide puncture resistance for the most extreme terrain. It is the radial tire of choice for #TeamITP's extreme desert racing.

- Unique, multi-surface, non-directional tread design improves off-road traction and versatility
- More openly spaced tread pattern to handle desert terrains and slick rock conditions
- 8-ply radial construction



SPECIFICATIONS				
SIZE	PLY	WEIGHT	MFG #	PART #
31x9.5R15	8	39.3	6P0516	262183

SAVAGE XT

- The ITP Savage tire has been designed to handle the increased power, weight, and speed of modern UTVs, including those capable of reaching up to 100 mph. The tread pattern provides superior traction in rocky terrains, ensuring an exceptional grip and confident ride on the most challenging adventures.



SPECIFICATIONS				
SIZE	PLY	WEIGHT	MFG #	PART #
28x10R-14	8	45.5	6P2068	264090
30x10R-14	8	50.6	6P2062	264091
30x10R-15	8	50.9	6P2063	264092
32x10R-15	8	51	6P2017	264093
32x10R-16	8	54.5	6P2044	264094
35x10R-15	8	63	6P2045	264095
35x10R-16	8	58.9	6P2046	264096
HARC 32x10R-15	8	51	6P2228	264097
HARC 35x10R-15	8	63	6P2229	264098



ITP TIRES & WHEELS

COYOTE



Specifically designed for high horsepower UTV and SxS vehicles, the 8 ply rated Coyote tire is a radial performance tire that is compliant with DOT standards and proudly made in the USA.

- Unmatched traction and side bite
- Predictable lateral stability
- Surgical steering response
- Premier desert tire for high horsepower vehicles
- Dominates rough, hard-pack, gravel and sandy terrain
- Staggered width shoulder lugs
- Optimal footprint for even pressure distribution

SPECIFICATIONS				
SIZES	PLY	WEIGHT	MFG #	PART #
28x10R-14	8	34.4	6P1994	264084
30x10R-14	8	37.8	6P1995	264085
30x10R-15	8	37.8	6P1996	264086
32X10R-15	8	44.1	6P0809	262216
27X9R-14	8	31.5	6P0810	262219
27X11R-14	8	36.8	6P0811	262220
33X10R15	8	46	6P0753	262225
35X10R15	8	54.3	6P0913	262226

BLACKWATER EVOLUTION



Innovative new non-directional design for awesome traction

- Smooth riding, superb handling 8-ply-rated radial construction
- Specifically engineered for excellent performance on side-by-side UTV applications
- All-new "Tough Tread" rubber compound offers exceptional wear and abrasion resistance
- Sidewall Armor™ protects vulnerable shoulder area from penetration, greatly increasing reliability
- Built to exceed the demands of today's side-by-side UTVs

SPECIFICATIONS				
SIZES	PLY	WEIGHT	MFG #	PART #
26X9R-12	8	26.4	6P0041	262130
26X11R-12	8	30.1	6P0040	262131
27X9R-12	8	26.5	6P0064	262132
27X11R-12	8	30.3	6P0063	262133
27X9R-14	8	27.8	6P0062	262134

SPECIFICATIONS				
SIZES	PLY	WEIGHT	MFG #	PART #
27X11R-14	8	31.8	6P0061	262135
28X10R-12	8	30.5	6P0106	262136
28X-9R-14	8	29.8	6P0113	262137
28X10R-14	8	31.1	6P0102	262138
28X11R-14	8	32.3	6P0115	262139
30X10R-14	8	33.2	6P0116	262141



CRYPTID

Proven "chevron" style tread pattern, designed to deliver unparalleled forward traction

- Lug Height is graduated, starting at 1.5 inches at center growing to 2 inches at the shoulder
- The resulting paddle-like shoulder configuration provides maximum side bite for climbing in and out of the mud without compromising ride comfort on trails and hard pack

SPECIFICATIONS				
SIZES	PLY	WEIGHT	MFG #	PART #
27x10-14	6	40.2	6P0775	262197
28x10-14	6	40.2	6P0776	262198
30 x 9-14	6	42.2	6P0351	262199
30 x 10-14	6	43.8	6P0347	262175
30 x 11-14	6	45.1	6P0808	262200

SPECIFICATIONS				
SIZES	PLY	WEIGHT	MFG #	PART #
32 x 10-15	6	50.4	6P0348	262176



SAND STAR

Extremely lightweight yet durable carcass uses a special rubber compound that delivers an ideal level of flotation, flexibility and cornering capability

- Front Sand Star features a patent-pending "dual rib" design for unmatched steering control
- Rear Sand Star uses eight 30mm main paddles as well as eight "mini scoops"
- This patent-pending design creates a much quicker hook-up and acceleration than anything else on the market today

SPECIFICATIONS				
SIZES	PLY	WEIGHT	MFG #	PART #
22X8-10	2	10.4	5000426	262146
20X11-10	2	12.6	5000456	262149
20X11-10	2	12.6	5000466	262150
20X11-9	2	11.8	5000496	262153
20X11-9	2	11.8	5000506	262154
18X9.50-8	2	9	5000526	262156



TERRA CROSS R/T

Ideal for mud, snow and sand

- The TerraCross R/T tire line uses smooth riding radial XD (Extreme Duty) construction - an extra sidewall ply and increased sidewall and tread rubber thickness for improved puncture protection
- Extra-tough rubber compound significantly increases tread life Interlocking tread pattern and wide footprint result in exceptional traction and flotation
- The wrap-around shoulder lugs offer excellent sidewall protection and traction when navigating rutted trails

SPECIFICATIONS				
SIZES	PLY	WEIGHT	MFG #	PART #
25x8R-12	6	20.7	560423	262109
25x10R-12	6	25.2	560424	262110
26x9R-12	6	24.4	560475	262111
26x11R-12	6	30.3	560476	262112

SPECIFICATIONS				
SIZES	PLY	WEIGHT	MFG #	PART #
26X8X14	6	20.5	6EE4821*	262205
26x9R-14	6	24.6	560411	262114
26X10X14	6	28	6EE4831*	262204
26x11R-14	6	33.7	560412	262115



ITP TIRES & WHEELS

MT911

Elevate your UTV's performance with the ITP Versa Cross® V3 tire, your ultimate companion for tackling hard pack to intermediate terrains. Designed for modern high-performance UTVs, this tire offers extreme performance that's second to none. Compliant with DOT test standards, this tire offers both performance and safety, suitable for a wide range of off-road adventures. With 8-ply rated radial construction and increased sidewall strength, you can venture into the unknown with confidence.



SPECIFICATIONS				
SIZES	PLY	WEIGHT	MFG #	PART #
27x10-14	8	42.5	6P1948	262242
28x10-14	8	43.4	6P1949	262243
30x10-14	8	45.4	6P1936	262244
30x10-15	8	47.3	6P1937	262245
32x10-14	8	53.9	6P1951	262246
34x10-15	8	61.7	6P1952	262248
32X10-15	8	54.3	6P1846	262355

TENACITY

The Tenacity XSR is ITP's first steel belted radial design tailored for the extreme rider/competitor.

- Reinforced steel belts offer the competitive/aggressive rider improved puncture resistance;confidence-inspiring high-speed stability;and traction on par with light truck/off-road tires
- A more rigid body ply construction method provides crisp steering response



SPECIFICATIONS				
SIZES	PLY	WEIGHT	MFG #	PART #
28x10.00R14 NHS	8	35.2	6P2006	264087
30X10R14	8	38.6	6P2007	264088
32x10.00R15 NHS	10	42.9	6P1475	262237

INTERSECT

Elevate your UTV's performance with the ITP Intersect tire – a powerhouse designed to conquer any terrain. With an impressive 8-ply rated radial construction, this tire is ready to handle the toughest terrains you throw at it. Its massive multi-angle tread blocks provide unmatched grip, ensuring you stay in control on any terrain. The strategically staggered shoulder lugs further enhance off-road performance, giving you the confidence to tackle even the most demanding landscapes. Plus, rest easy knowing this high-quality tire is proudly made in the USA, ensuring top-notch craftsmanship and reliability.



SPECIFICATIONS				
SIZES	PLY	WEIGHT	MFG #	PART #
30x10R-14 NHS	8	47.3	6P1789	262238
30x10R-15 NHS	8	46.8	6P1790	262239
32x10R-15 NHS	8	48.1	6P1889	262240
35x10R-15 NHS	8	54.2	6P1791	262241



VERSA CROSS

Super-deep rim guard designed to protect the rim lip on styled aftermarket wheels

- “Tough Tread” rubber compound protects against cuts, chips and tread wear
- Tread Design
- 3/4-inch lug depth with center lug channels construction
- Compliant with DOT Test Standards



SPECIFICATIONS				
SIZES	PLY	WEIGHT	MFG #	PART #
30X10R-14	8	44	6P0890	262221



VERSA CROSS V3

Elevate your UTV's performance with the ITP Versa Cross® V3 tire, your ultimate companion for tackling hard pack to intermediate terrains. Designed for modern high-performance UTVs, this tire offers extreme performance that's second to none. Compliant with DOT test standards, this tire offers both performance and safety, suitable for a wide range of off-road adventures. With 8-ply rated radial construction and increased sidewall strength, you can venture into the unknown with confidence.



SPECIFICATIONS				
SIZES	PLY	WEIGHT	MFG #	PART #
28X10R-18	8	32	6P1380	262347
33X10R-15	8	44	6P1375	262348
33X10R-18	8	40	6P1376	262349
33X10R-20	8	44.6	6P1377	262350
35X10R-18	8	41.8	6P1378	262351
35X10R-20	8	45.1	6P1379	262352
30X10R-14	8	39.6	6P1763	262356
32X10R-14	8	42.6	6P1761	262358
32X10R-15	8	42.8	6P1760	262359

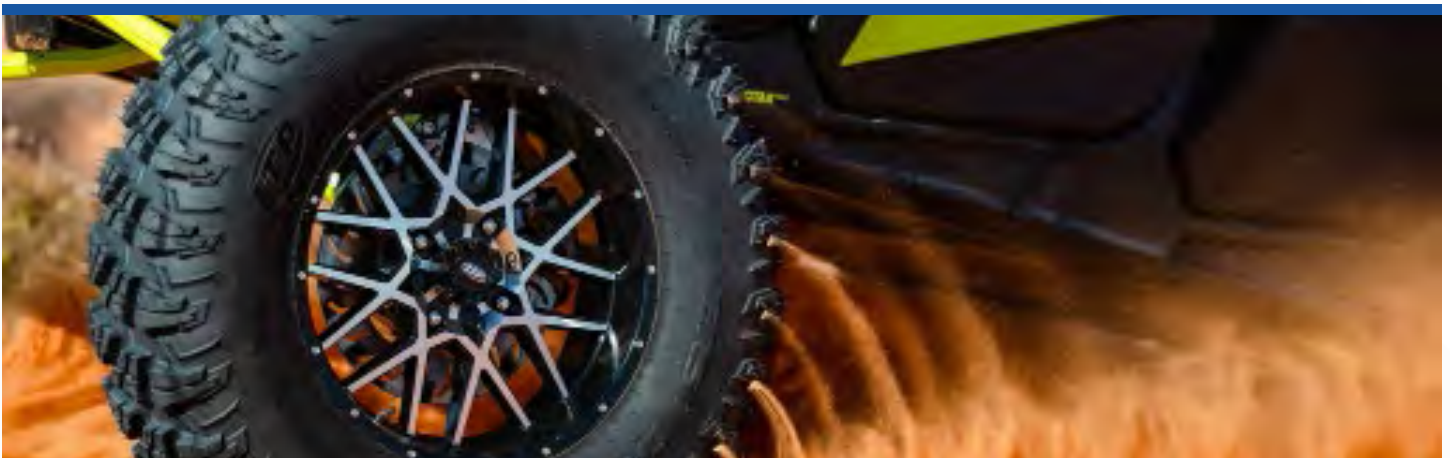



ITP TIRES & WHEELS



SS ALLOY SS212

Strong, lightweight, and a striking appearance make this one-piece aluminum wheel a great choice for ATVs and UTVs.

Highlights:

- Heavy-duty 12-inch ATV wheel rated at 700 lbs., 14-inch side-by-side UTV applications rated at 800 lbs!
- Built using ITP's Advancecast process to exact QS9000 quality specifications
- Limited Lifetime Warranty

SPECIFICATIONS					
SIZES	FINISH	BOLT PATTERN	OFFSETS PS	MFG #	PART #
14x6	Machined	4/137	4+2	1428377404B	263179
14x6	Machined	4/137	4+2	1422232404B	263414
14X6	Black	4/137	4+2	1428377536B	263190
14X8	Black	4/137	5+3	1428383536B	263193
14X6	Black	4/137	4+2	1422233536B	263416
14X8	Black	4/137	5+3	1422235536B	263417

SS ALLOY SS312

SS312 joins the proven SS Alloy line as one of the strongest, lightest and best looking one-piece aluminum wheels on the market today!

- Features a stealthy matte black finish with bright, diamond-cut machined accents topped with a heavy clear coat
- Built using ITP's exclusive Advancecast process to exact QS 9000 quality specifications
- Limited Lifetime Warranty



SPECIFICATIONS					
SIZES	FINISH	BOLT PATTERN	OFFSETS PS	MFG #	PART #
14X8	Black	4x110	5+3	1428447536B	263206
14X6	Black	4/137	4+2	1428454536B	263213

SPECIFICATIONS		
DESCRIPTION	MFG #	PART #
ALLOY SS312 & S6 MACH/BLACK CAP	C110SS	264041
ALLOY SS312 & S6 MACH/BLACK CAP	C137SS	264042
ALLOY SS312 & S6 MACH/BLACK CAP	C156SS	264043

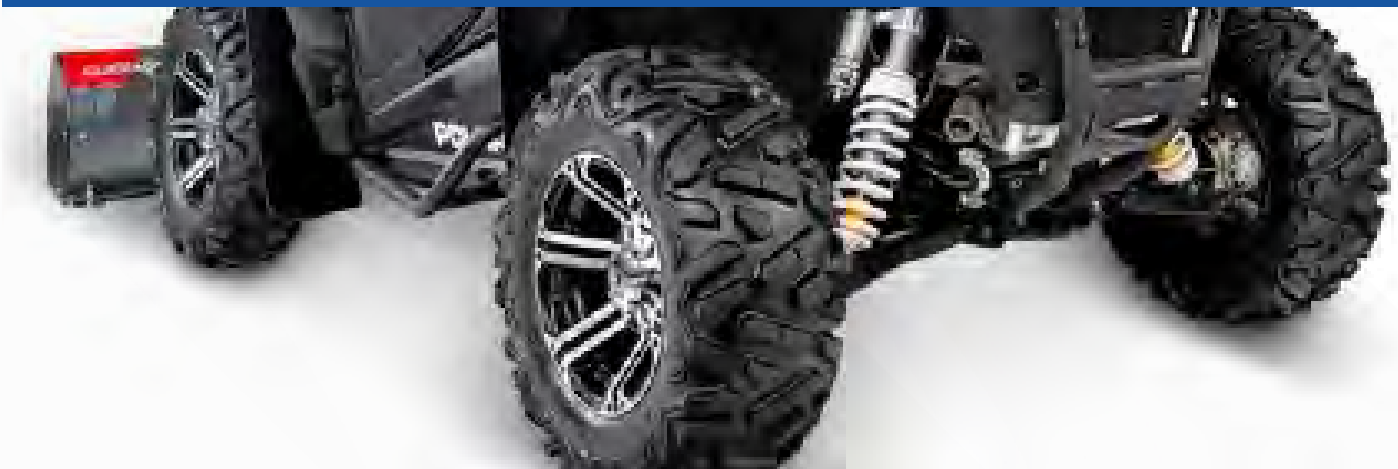



SS ALLOY SS316

With a 1,000-pound load rating, the SS316 offers contemporary styling to make your ride stand out in a crowd. Built to handle the demands of today's side-by-side UTVs.



- SS316 uses all-new "Rock Armor" reinforced inner wheel lip to make an already durable wheel even more bulletproof.
- Built using ITP's exclusive Advancecast process to exact QS 9000 quality specifications
- Limited Lifetime Warranty
- Matte Black Finish
- Matching SS wheel cap is included.
- Technical Specifications

SPECIFICATIONS					
SIZE	FINISH	BOLT PATTERN	OFFSETS PS	MFG #	PART #
12X7	Black	4x110	5+3	122855536B	263244

SS ALLOY CHROME CAP



SPECIFICATIONS		
SIZES	MFG #	PART #
SS ALLOY 4/110 & 4/115 CHROME CAP	P110SS	264037
SS ALLOY 4/110 & 4/115 CHROME CAP	B110SS	264038
SS ALLOY 4/137 CHROME CAP	P137SS	264039
SS ALLOY 4/156 CHROME CAP	P156SS	264040

SS ALLOY SS216 & 316 BLACK CAP



SPECIFICATIONS		
SIZES	MFG #	PART #
BLACK CAP 4/110 & 4/115	BO110SS	264044
BLACK CAP 4/137 & 4/156	BO137SS	264045

SS ALLOY TALL VIKING/WOLVERINE CAP



SPECIFICATIONS		
DESCRIPTION	MFG #	PART #
ALLOY TALL VIKING/WOLVERINE CAP CHROME	332131SS3R	264071
ALLOY TALL VIKING/WOLVERINE CAP BLACK	332131SS1R	264072



ITP TIRES & WHEELS

DELTA STEEL

The Delta Steel wheel line, complete with precision-rolled rims, satisfies the need for a high-quality wheel at an affordable price.

- Highlights:
- Lightweight D-window center design that's both attractive and strong
- Precision-rolled rims



SPECIFICATIONS					
SIZES	FINISH	BOLT PATTERN	OFFSETS PS	MFG #	PART #
12X7	Black	4/110	2+5	1222859014B	263038
12X7	Black	4/110	4+3	1222856014B	263039
12X7	Black	4 x 115	5+2	1225564014	263040
12X7	Black	4/137	4+3	1222864014B	263041
12X7	Black	4/137	2+5	1222862014B	263042
12X7	Black	4/137 12mm	4+3	1222863014B	263043
12X7	Black	4/156	4+3	1222865014B	263044
12X7	Black	4/4	2+5	1222858014B	263045
12X7	Black	5/4.5	2+5	1222866014B	263046
14x7	Black	4/110	5+2	1425553014B	263425
14x7	Black	4/110	2+5	1425544014B	263426
14x7	Black	4/137	4+3	1425573014B	263427
14x7	Black	4/137	4+3	1422319014B	263428
14x7	Black	4/156	4+3	1425579014B	263429
14x7	Black	4/156 12mm	4+3	1422755014B	263430
12X7	Black	4/156 12mm	4+3	1222857014B	263461

CHROME CAP



SPECIFICATIONS		
PCS	DESCRIPTION	PART #
	STEEL 4/110 CHROME CAP	264024
BOX OF 4	STEEL 4/110 CHROME CAP	264025
	STEEL 4/110 BLACK CAP	264026
BOX OF 4	STEEL 4/110 BLACK CAP	264027

TORNADO

The powerful Tornado wheel spins circles around the competition with its head-turning design, outstanding load rating, and unbeatable durability.

- Eight spoke center configuration with beveled edges as well as unmatched structural integrity for conquering challenging terrain.
- Offers ITP Exclusive "Rock Armor" inner wheel lip to provide unequalled structural integrity.
- Limited Lifetime Warranty
- Includes valve stem and center cap



SPECIFICATIONS					
SIZE	FINISH	BOLT PATTERN	OFFSETS PS	MFG #	PART #
14x7	MATTE BLACK	4/110	2+5	1421954727B	263291



HURRICANE

The first wheel in ITP's Storm Series Line, the Hurricane offers exceptional strength in a modern, stand out design.



- Features eight sets of X-shaped wheel spokes.
- Offers ITP® Exclusive "Rock Armor" inner wheel lip to provide unequalled structural integrity.
- Unique automotive-like center design
- Lifetime Structural Warranty
- Valve stem and center cap included

SPECIFICATIONS					
SIZES	FINISH	BOLT PATTERN	OFFSETS PS	MFG #	PART #
12X7	MATTEBLACK	4/156	4+3	1228630536B	263279
14X7	MATTEBLACK	4/156	4+3	1428638536B	263285

SPECIFICATIONS		
DESCRIPTION	MFG #	PART #
ITP HURRICANE CAP ALL	C110ITP	264065

INERTIA®

Revolutionize your off-road adventures with the ITP Inertia® wheel – a blend of strength and style that redefines the off-road experience. Designed to seamlessly complement your vehicle's original aesthetics, the Inertia® wheel not only delivers premium fitment and exceptional handling but also adds a rugged touch to your ride that impresses.



- ITP Exclusive Rock Armor inner wheel lip for unparalleled structural integrity
- Available in Matte Black with Machined Accents or Bronze finishes for versatile style options
- Close-to-OE offsets ensure superior fitment and performance
- 1200 lbs load rating for durability in tough terrains
- Beadlock technology provides secure bead seating for enhanced safety and control
- Center cap and valve stem included

SPECIFICATIONS					
SIZES	FINISH	BOLT PATTERN	OFFSETS PS	MFG #	PART #
14X7	BLACK/MACHINED	4x136	6+1 (+50mm)	1422524727B	263463
14X7	BLACK/MACHINED	4x136	5+2 (+40mm)	1422525727B	263464
14X7	BLACK/MACHINED	4x156	5+2 (+40mm)	1422526727B	263465
15X7	BLACK/MACHINED	4x136	5+2 (+30mm)	1522527727B	263466
15X7	BLACK/MACHINED	4x136	6+1(+50mm)	1522528727B	263467
15X7	BLACK/MACHINED	4x136	5+2 (+40mm)	1522529727B	263468
15X7	BLACK/MACHINED	4/156	5+2 (+40mm)	1522530727B	263469



SPECIFICATIONS		
DESCRIPTION	MFG #	PART #
INERTIA WHEEL REPLACEMENT RING 14"	RINGVL-14BLK	264080
INERTIA WHEEL REPLACEMENT CENTER CAP	B110VL	264082



ITP TIRES & WHEELS

MOMENTUM®



Experience unparalleled off-road performance and style with the ITP Momentum® Wheel – a masterpiece of design and durability. Engineered for modern UTVs and ATVs, the Momentum® Wheel features offsets closer to OE for optimal fitment and performance, while its exclusive “Rock Armor” inner wheel lip guarantees unrivaled structural integrity.

- Striking gloss black finish with milled edges for visual appeal and durability
- Closer-to-OE offsets ensure optimal fitment and performance on modern UTVs and ATVs
- Exclusive “Rock Armor” inner wheel lip provides unmatched structural integrity for tackling tough terrains

SPECIFICATIONS					
SIZES	FINISH	BOLT PATTERN	OFFSETS PS	MFG #	PART #
14x7	BLACK/MACHINED	4x137	5+2 (+30mm)	1422735731B	263471
14x7	BLACK/MACHINED	4x156	5+2 (+30mm)	1422736731B	263472
15x7	BLACK/MACHINED	4x156	5+2 (+30mm)	1522741731B	263475
18x6.5	BLACK/MACHINED	4x137	4+2.5(10mm)	1822742731B	263476
18x6.5	BLACK/MACHINED	4x156	4+2.5(10mm)	1822743731B	263477
20x6.5	BLACK/MACHINED	4x137	4+2.5(10mm)	2022744731B	263478
20X6.6	BLACK/MACHINED	4x156	4+2.5(10mm)	2022745731B	263479



SD BEADLOCK CAP BLACK

SPECIFICATIONS		
SIZE	MFG #	PART #
BLACK WITH MACHINE 4/137 & 4/137	C137SD	264047

ITP REPLACEMENT KEY FOR ALUG20BX

SPECIFICATIONS		
SIZE	MFG #	PART #
ITP REPLACEMENT FOR ALUG20BX	ALUG20KEY	264068

ITP LUG NUT



SPECIFICATIONS		
PCS	DESCRIPTION	PART #
BOX OF 16	3/8"-24 FLAT CHROME LUG NUT	264001
BOX OF 16	3/8"-24 TAPERED CHROME LUG NUT	264003
BOX OF 16	10MM X 1.25 TP TAPERED CHROME LUG NUT	264005
BOX OF 16	10MM X 1.25 TP FLAT CHROME LUG NU	264007
BOX OF 16	12MM X 1.25 TP FLAT CHROME LUG NUT	264009
BOX OF 16	10MM X 1.50 TP TAPERED CHROME LUG NUT	264011
BOX OF 16	12MM X 1.50 TP TAPERED CHROME LUG NUT	264013
BOX OF 16	12MM X 1.25 TP TAPERED CHROME LUG NUT	264014
BOX OF 16	12XMM X1.50 TP TAPERED SPLINED LUG NUT	264015
BOX OF 16	12MM X 1.25 TP TAPERED CHROME LUG NUT	264020
BOX OF 16	10MM X 1.25 TP TAPERED OEM STYLE LUG NUT	264022
BOX OF 16	12mm x 1.25 TAPERED SPLINED LUG NUT	264054
BOX OF 16	10mm x 1.25 TP TAPERED BLACK LUG NUT	264055





DESIGNED

FOR YOUR

JOURNEY

ON THE ROAD, ON THE TRAIL OR ON THE RACETRACK, YOU CAN COUNT ON KENDA QUALITY. OUR TIRES ARE ENGINEERED FOR PERFORMANCE AND VALUE ACROSS A WIDE RANGE OF INTERESTS AND APPLICATIONS. SEE WHY KENDA IS THE RIGHT CHOICE. IT'S YOUR MOVE.



K533 Klaw MX

- Dual rotation tread design; soft to medium terrain, medium to hard terrain
- Lightweight 4-ply rated casing reduces unsprung weight
- Available in 3 sizes



SIZES	PLY	PART #
18X10.5-9	4	250031



K532 | K533 Klaw XC

- Meets the demands of the toughest cross country terrain
- Performs for a mix of terrains ranging from cross country to short course racing
- Dual rotation tread design; soft to medium, medium to hard terrain
- 6-ply rated casing
- Available in 11 popular sizes



SIZES	PLY	PART #
22X7-10	6	250002
25X8-12	6	250001
20X11-10	6	KD53305
20X11-9	6	KD53303
21X7-10	6	KD53201
22X11-10	6	250004
22X11-8	6	KD53302
22X11-9	6	KD53304



K300 Dominator

- Excellent choice for the recreational driver
- Split knob design for exceptional cornering and breaking
- Tough, durable casing and long lasting compound



SIZES	PLY	PART #
22X11-8	4	KD30003



K284 FRONT MAX

- First front rib tire to be designed exclusively for ATV use
- Each knob is reinforced for superior tracking and cornering
- One of the best and most popular OE replacement tire on the market
- Puncture resistant casing
- Available in 8 sizes

SIZES	PLY	PART #
20X7-8	8PR	250180
21X7-10	8PR	250181
21X8-9	8PR	250182

SIZES	PLY	PART #
22X11-8	8PR	250184
22X8-10	8PR	250185
23.5X8-11	8PR	250186
23X8-11	8PR	250187



K530 PATHFINDER

The Pathfinder is a great all-conditions tire for utility applications.



- Perfect OE replacement tires for 4x4 ATV and UTV
- Tread designed for a smooth easy ride

SIZES	PLY	PART #
16X8-7 F	2	KD53001
18X7-7 F	2	KD54001
19X7-8	2	KD53002
23X8-11 F	2	KD54002
24X8-12	2	KD53010
25X8-12 F	2	KD53012
18X9.5-8	2	KD53003

SIZES	PLY	PART #
22X11-10	2	KD53007
22X11-8	2	KD53004
22X11-9	2	KD53005
24X9-11	2	KD53009
25X10-12	4	KD53011
25X12-10	2	KD53008
25X12-9	2	KD53006



K290 SCORPION

- Provides versatility for a mix of terrains and applications
- Ideal choice for riders seeking knobby performance at a low price
- Lightweight, easy rolling tread
- Puncture resistant
- Good match for our K284 Front Max
- Available in 11 sizes



SIZES	PLY	PART #
14.5x7-6	2	250188
16X8-7	2	250189
18X9.5-8	2	250190
19X7-8	2	250191
20X10-8	2	250192

SIZES	PLY	PART #
20X10-9	2	250193
20X7-8	2	250194
22X10-8	2	250195
22X11-8	2	250196
24X9-11	2	250197
25X12-9	2	250198

K3211/ K3210F HAVOK



- Optimized tread spacing designed for all sports and race ATV applications.
- Unique race compound delivers superior traction while extending tread life.
- Laboratory tested and competition-proven in the most demanding conditions.
- Non-directional 6-ply-rated carcass.
- All-new profile for predictable steering, braking and acceleration.



SIZES	PLY	PART #
20X6-10	4	250619
18X10-8	4	250620
18X8-8	4	250621
21X7.00-10	4	250578
20X11.00-9	4	250579

K299 BEARCLAW



- 6-ply rated extra touch casing resists punctures
- Angled knobs dig into the terrain for maximum traction
- Center lugs provide extra traction and better control
- Build-in rim guard protects your wheel from dings/dents
- Long-range tread compound
- Available in 24 sizes



SIZES	PLY	PART #	SIZES	PLY	PART #
26X11X12	6	250325	25X12.5-9	6	KD29922
27X11X12	6	250327	27X9X12	6	250326
22X12-8	6	KD29901	22X7X11	6	250410
22X12-9	6	KD29902	22X8-10	6	KD29903
23X10-10	6	KD29906	22X12-10	6	KD29904
24X11-10	6	KD29907	23X7-10	6	KD29905
25X12.5-10	6	KD29908	23X8-11	6	KD29909
24X10-11	6	KD29911	24X9-11	6	KD29910
25X10-11	6	KD29912	24X8-12	6	KD29914
25X12.5-11	6	KD29913	25X8-12	6	KD29915
25X10-12	6	KD29916	26X9-12	6	KD29918
25X12.5-12	6	KD29917	25X8-11	6	KD29923
26x12-12	6	250570	27X10-12	6	250571
			27x12-12	6	250572





K592 BEARCLAW EVO



- With a priority on reducing weight, without sacrificing durability, the Bear Claw Evo has raised the bar in all areas of performance
- Tread pattern is designed to perform exceptionally across all terrains
- Large Center knobs for improved straight line and braking traction
- Recessed-dimpled knobs for improved wet traction
- Unique shaped transition knobs for improved cornering traction & handling
- 6-ply rated casing allows for the exceptional puncture resistance while keeping weight to a minimum
- Available in 10 popular sizes

SIZES	PLY	PART #
25X8-12	6	250411
26X9-12	6	250413
26X9-14	6	250417
27X9-12	6	250415
28X9-14	6	250477

SIZE	PLY	PART #
25X10-12	6	250412
26X11-12	6	250414
26X11-14	6	250418
27X11-12	6	250416
28X11-14	6	250478

K587 BEARCLAW HTR



- 8-ply rated radial casing structure providing the highest level of puncture resistance and excellent handling
- Tread pattern provides high traction on a wide range of terrain
- Center knob design provides low vibration and a smooth ride
- Tall knobs to dig into the dirt and mud while also spaced apart to push the dirt away and self clean
- available in 10 popular sizes

SIZES	PLY	PART #
25 X 8R-12	8	536-106
25 X 10R-12	8	536-107
26 X 9R-12	8	536-108
26 X 11R-12	8	536-109
27X9.5R/14	8	250560

SIZES	PLY	PART #
27 X 9R-12	8	536-110
27 X 11R-12	8	536-111
26 X 9R-14	8	536-112
26 X 11R-14	8	536-113
28X9R14	8	250419
28X11R14	8	250420

K299A BEARCLAW XL



- 6-ply rated extra touch casing resists punctures
- Same great tire now with deeper tread.
- Angled knobs dig into the terrain for maximum traction
- Center lugs provide extra traction and better control
- Build-in rim guard protects your wheel from dings/dents
- Long-range tread compound
- Available in 6 popular sizes.

SIZES	PLY	PART #
25X12.5-12	6	250558
25X10-12	6	250557
25X8-12	6	250556

SIZE	PLY	PART #
27X9-12	6	250559
24X10-11	6	250554
24X8-12	6	250555

K538 EXECUTIONER



- Designed to meet the demands of the muddiest 4x4 riding terrain
- Tread design for deep down traction, even in the muddiest conditions
- Reinforced knobs to reduce knob rollover at low pressure, improve ride comfort and increase tread life
- Dimpled tread surface for improved traction on drier conditions
- 6-ply rated with extra tough casing resists punctures
- Rim saver feature for protection against rock and rut damage
- Available in 8 popular sizes



SIZES	PLY	PART #
25X8-12	6	KD53801
26X10-12	6	KD53803
27X10-12	6	KD53805
28x9-14	6	250421

SIZES	PLY	PART #
25X10-12	6	KD53802
26X12-12	6	KD53804
27X12-12	6	KD53806
28x11-14	6	250422



K3204R KLEVER X/T

- The lightest steel belted 8 ply UTV tire on the market
- Based off our popular light truck tire, the Klever R/T KR601
- Studdable design for winter snow and ice riding
- Smooth ride quality with low rolling resistance and exceptional traction on all surfaces
- Robust bead protector to shield wheel from rocks



SIZES	PLY	PART #
27X9R14	8	250603
28X10R14	8	250577
30X10R14	8	250592

SIZES	PLY	PART #
32X10R14	8	250612
32X10R15	8	250593
27X11R14	8	250613



K576A KONGUR

- Ultimate trail and hard terrain UTV/SXS tire
- 8-ply rated radial design design enables a smooth quality ride
- Light truck inspired tread pattern
- Available in 28" & 30" Sizing



SIZES	PLY	PART #
30X10R14	8	250529

K3213 CROSS TRAIL

The Kenda Cross Trail was developed at our Ohio Tech Center in Canton, Ohio. It serves as the factory specification tire for select Polaris UTVs. Utilizing 3SMA (3-step multi-angle) technology, the Cross Trail ensures superior traction throughout its lifespan. We have strategically designed variable depth knob siping to enhance grip on the toughest surfaces. Rigorous testing has confirmed that the Cross Trail is the premier tire for any terrain.



- 3SMA (3 step multi-angle) technology ensures optimal traction through the life span of the tire, braking performance and tread flex
- 8 ply carcass construction for puncture resistance
- Strategically placed variable depth knob siping to enhance grip in the toughest terrains
- Advanced staggered shoulder block designed to reduce weight, while also maximizing traction in loose terrain

SIZES	PLY	PART #
27X9R14	8PR	250627
28X9R14	8PR	250628
29X9R14	8PR	250629
29X11R14	8PR	250630
30X9R14	8PR	250631

SIZES	PLY	PART #
30X10R14	8PR	250632
30X10R15	8PR	250633
30X11R15	8PR	250634
32X10R15	8PR	250635
33X10R15	8PR	250636

MASTODON HT

Your new favorite UTV tires are here! The Mastodon HT tires, part of the all-new MASTODON line, were designed to be the ultimate trail and hard terrain tires for, ATV, UTV and SXS use. The light truck tire inspired tread pattern makes for a super smooth ride for a variety of surfaces, from hard pack to intermediate. They were made to excel in both high-speed desert conditions as well as tight, rocky terrains. The heavy-duty radial 8-ply rated casing provides the ultimate puncture resistance for a quality ride that handles like a pro.



- Part of the all-new MASTODON line, the HT was designed to be the ultimate trail and hard terrain UTV/SXS tire.
- Smooth Ride Quality with light truck tire influenced tread pattern.
- Build to exceed in both high-speed desert conditions, as well as tight rocky terrain.
- Heavy-duty radial 8 ply rated casing for the ultimate in puncture resistance.

SIZES	PLY	PART #
27X11R12	8PR	250594

MASTODON AT



Your new favorite UTV tires are here! The Mastodon HT tires, part of the all-new MASTODON line, were designed to be the ultimate trail and hard terrain tires for, ATV, UTV and SXS use. The light truck tire inspired tread pattern makes for a super smooth ride for a variety of surfaces, from hard pack to intermediate. They were made to excel in both high-speed desert conditions as well as tight, rocky terrains. The heavy-duty radial 8-ply rated casing provides the ultimate puncture resistance for a quality ride that handles like a pro.

- Part of the all-new MASTODON line, the HT was designed to be the ultimate trail and hard terrain UTV/SXS tire.
- Smooth Ride Quality with light truck tire influenced tread pattern.
- Build to exceed in both high-speed desert conditions, as well as tight rocky terrain.
- Heavy-duty radial 8 ply rated casing for the ultimate in puncture resistance.

SIZES	PLY	PART #
27X11R12	8PR	250599
28X9R14	8PR	250600



MAXXIS®

STATE OF ART

ALL TERRAIN

UTV & ATV TYRE

MAXXIS: BUILT FOR CHAMPIONS, DESIGNED FOR YOU.



RAZR

- At its best when pushed to the limit, the Razr sports a championship-proven tread design with superior puncture resistance, along with a wide profile for increased grip during acceleration and braking.
- Frequent rear tire choice for GNCC and WORCS racers
- 6-ply-rated

SIZES	PLY RATING	MFG #	PART #
AT21X7.00-10	4	TM00475100	844113
AT20X11-9	4	TM07200000	844122
AT20X11-9	6	TM07201000	844123
20X11.00-10	4	TM00481100	844124
22X11.00-9	6	TM00483100	844125



RAZR2

- The Razr2 grabs heaps of traction in various terrains, but is best suited for intermediate to muddy and loose-over-hard desert conditions. The front tire's increased tread depth and angled shoulder knobs offer improved steering and braking control.
- A go to front tire for GNCC and WORCS racers
- 6-ply-rated

SIZES	PLY RATING	MFG #	PART #
AT21X7-10	6	TM00279800	844129
AT22X7-10	6	TM00299700	844130
AT20X11-9	6	TM00279900	844132



RAZR PLUS MX

- An ATV MX National Championship-winning tire for Chad Wiene, the Razr Plus MX features a new tread compound and pattern for increased traction and predictable cornering. The Razr Plus MX is the most advanced ATV MX tire in the Razr lineup.
- 4-ply-rated

SIZES	PLY RATING	MFG #	PART #
AT20X6-10	4	TM01033100	844134
AT18X10-8	4	TM01034100	844135

MAXXIS TIRES



WORKZONE

- The Workzone by Maxxis is a purpose-built utility tire designed to help you get the job done over a wide variety of terrains and conditions. The high land ratio design on the tread enhances tread life, load capacity, and traction.
- 6 ply-rated bias construction
- Specially formulated compound provides long, durable tread wear
- Specifically designed for utility/working applications

SIZES	PLY RATING	MFG #	PART #
25X8.00-12	6	TM00119800	844103
25X10.00-12	6	TM00119900	844104



BIGHORN RADIAL

- If there were a Hall of Fame for ATV tires, the now-legendary Maxxis Bighorn would be front and center. The tire of choice for myriad riders ranging from pros to weekend enthusiasts, the original Bighorn is the most durable offering in the Bighorn line-up.
- 6-ply-rated radial construction

SIZES	PLY RATING	MFG #	PART #	SIZES	PLY RATING	MFG #	PART #
AT25X8R12	6	TM00296600	844002	AT26X11R14	6	TM00298700	844009
AT26X9R12	6	TM00279500	844003	AT26X12R12	6	TM00279700	844010
AT26X9R14	6	TM00298400	844004	AT27X12R12	6	TM00297500	844011
AT27X9R12	6	TM00297300	844005	28x10.00R14	6	TM00164400	844012
29X9.00R14	6	TM00746100	844006	29X11.00R14	6	TM00860100	844013
AT25X10R12	6	TM00296900	844008	30x10.00R14	6	TM00335900	844014



BIGHORN 2.0

- Based on the legendary Bighorn, the Maxxis Bighorn 2.0 tire is a lightweight racing-inspired version that mirrors the tread design of the original with slimmer lugs. Bighorn 2.0 is the lightest most versatile off-road racing tire in the bighorn lineup.
- Tire of choice for off-road racing champions Hunter Miller and Kyle Chaney
- 6-ply-rated radial construction

SIZES	PLY RATING	MFG #	PART #	SIZES	PLY RATING	MFG #	PART #
AT24X8	6	TM00246100	844016	AT26X11R12	6	TM00124100	844027
AT25X8R12	6	TM00090100	844017	27x11.00R12	6	TM00121800	844028
AT26X9R12	6	TM00270700	844018	28x10.00R12	6	TM00732100	844029
27x9.00R12	6	TM00121700	844019	AT26X11R14	6	TM00095100	844030
AT26X9R14	6	TM00094100	844020	27X11.00R14	6	TM00912100	844031
27X9.00R14	6	TM00911100	844021	28x11.00R14	6	TM00706100	844032
28x9.00R14	6	TM00705100	844022	29X11.00R14	6	TM00881100	844033
29X9.00R14	6	TM00880100	844023	30X10.00R14	6	TM00186300	844034
AT24X10	6	TM00247100	844025	30X10.00R15	6	TM00977100	844102
AT25X10R12	6	TM00091100	844026				



BIGHORN 3.0

- The first Bighorn to feature front directional tread, the Bighorn 3.0 was designed with maneuverability and durability in mind. Though not as versatile as the 2.0, if control and steering precision are your priority the 3.0 will make you smile.
- Front and rear-specific
- Directional front tire
- 6-ply-rated radial construction

SIZE	PLY RATING	MFG #	PART #
26X9.00R12	6	TM00948100	844035
26X11.00R12	6	TM00949100	844036
26X9.00R14	6	TM01050100	844037
27X9.00	6	TM01007100	844038

SIZES	PLY RATING	MFG #	PART #
26X11.00R14	6	TM01051100	844039
27X11.00	6	TM01001100	844040
29X9.00R14	6	TM00941100	844041
29X11.00R14	6	TM00940100	844042



CARNIVORE

- The Carnivore boasts a gnarly tread design that delivers excellent traction on rocks, roots, desert terrain, and mud. The Carnivore, like the Rampage is designed to conquer a wide variety of terrains.
- Aggressive all-terrain tread pattern
- 8-ply-rated radial construction
- Recommended Use: All-terrain

SIZES	PLY RATING	MFG #	PART #
28x10.00R14	8	TM00105300	844043
29x9.50R15	8	TM00186900	844044
30x10.00R14	8	TM00105200	844045
32x10.00R14	8	TM00155400	844046
31X10.00R15	8	TM00020300	844101

SIZES	PLY RATING	MFG #	PART #
32X10.00R15	8	TM00186800	844047
33x10.00R15	8	TM00306300	844110
35x10.00R15	8	TM00306200	844111
35X10.00R17	8	TM00367400	844174
37X10.00R17	8	TM00367500	844175



CARNIVORE RT

- Designed for maximum performance in muddy and rocky conditions, this tire is perfect for off-road enthusiasts who demand the best. With its durable construction and aggressive tread pattern, this tire provides superior traction and stability on even the toughest terrain. Whether you're navigating muddy trails or rocky outcroppings, the Carnivore RT will give you the confidence to tackle any obstacle.

SIZES	PLY RATING	MFG #	PART #
30X10.00R14	8	TM00370300	844176
32X10.00R14	8	TM00435900	844178
32X10.00R15	8	TM00436000	844179
28X10.00R14	8	TM00438500	844180
30X10.00R15	8	TM00438400	844181

MAXXIS TIRES



CARNAGE

- The Carnage features an aggressive tread design that's ready for any terrain, while also delivering precise steering, outstanding puncture resistance, and excellent ride comfort.
- Aggressive tread design for all-terrain use
- Great ride comfort and steering response
- Good puncture resistance

SIZES	PLY RATING	MFG #	PART #
29X9.00R14	8	TM00239700	844108
29X11.00R14	8	TM00239800	844109



MU511/MU521

- Featuring a generous contact patch and a robust, 6 ply-rated carcass, the MU511 front and the even wider MU521 rear ensure that you can haul heavy loads with ease. With a tread pattern similar to the Ceros, the MU511/MU521 also offers excellent traction and tread wear. Tall blocks and large void areas clear mud easily, so rainy, muddy weather is no problem for the MU511/MU521.
- Superior traction
- Durable, with sustained tread wear
- 6-Ply-Rated construction

SIZES	PLY RATING	MFG #	PART #
27X9.00-12	6	TM00065500	844138
27X11.00-12	6	TM00065600	844139
27X9.00R14	6	TM00139900	844140
27X11.00R14	6	TM00140000	844141
29X9.00R14	6	TM00256700	844142
29X11R14	6	TM00256600	844143

RAZR XT



- The RAZR XT was built for one purpose, and that purpose is winning.
- Steel-belted radial construction with exceptional cornering and steering qualities.
- Shoulder blocks extending over the sidewall improve traction in desert terrain while the center tread block design and arrangement are optimized to provide traction in a variety of terrains.
- New compound provides increased tear resistance and sidewall stiffness for even more traction.
- 8-ply-rated

SIZES	PLY RATING	MFG #	PART #
30X10.00R14	8	TM00296400	844112
32X10.00R15	8	TM00296300	844107
33X10.00R15	8	TM00296500	844177

LIBERTY



- The Maxxis Liberty has an 8-ply-rated radial carcass ready to shoulder heavy loads and a tread designed for ultimate control. Our best tire offering for desert racing, the Liberty features the long tread life you've come to expect from a Maxxis tire.
- Frequent choice of racers in Best in the Desert and SCORE racing
- Excellent tread wear
- 8-ply-rated radial construction

SIZES	PLY RATING	MFG #	PART #
28X10.00	8	TM00120900	844048
29X9.50R15	8	TM00187500	844049
29X9.50R16	8	TM00896100	844050

SIZES	PLY RATING	MFG #	PART #
30X10.00R14	8	TM00108000	844051
32x10.00R14	8	TM00170600	844052
32X10.00	8	TM00207900	844053

RAMPAGE



- An aggressive all-terrain tread pattern and 8-ply-rated radial construction allow the Rampage to handle abuse in harsh conditions and keep on going. If you're looking for a tire that can do just about everything the Rampage will not disappoint.
- Aggressive all-terrain tread pattern
- Excellent tread wear
- 8-ply-rated radial construction

SIZES	PLY RATING	MFG #	PART #
28X10.00R14	8	TM00148700	844105
30X10.00	8	TM00102900	844055
32X10.00R14	8	TM00187400	844056
30X10.00R15	8	TM00187300	844106
32X10.00R15	8	TM00187000	844057
MAXXIS RAMPAGE FURY 32X10.00R15	8	TM00259300	844182

ROXXZILLA



- The Roxxzilla delivers elite rock-crawling performance along with rugged, 8-ply rated radial construction.
- Tire of choice for 2020 and 2021 King of the Hammers UTV champions (Hunter Miller and Kyle Chaney)
- Select sizes available in two different compounds.
- Competition "sticky" compound (denoted by*)
- 8-ply-rated radial construction

SIZES	PLY RATING	MFG #	PART #
30X10.00 R1	8	TM00130700	844058
32X10.00R14	8	TM00161900	844059
35X10.00R14	8	TM00186400	844060
30X10.00R14	8	TM00118500	844061
32X10.00R14	8	TM00162000	844062

SIZES	PLY RATING	MFG #	PART #
32X10.00R15	8	TM00310000	844098
32X10.00R15	8	TM00187200	844099
35X10.00R15	8	TM00117400	844097
37X10.00R17	8	TM00352400	844173

MAXXIS TIRES



CORONADO

- Probably the most durable desert tire in our lineup, the Coronado's strong, 8-ply rated radial carcass soaks up the shock from rocks and sand whoops for ultimate control and maximum puncture resistance. If you're looking for a lighter desert offering check out the Liberty.
- 8-ply-rated radial carcass designed for supreme performance and longevity

SIZES	PLY RATING	MFG #	PART #
25X8.00R12	8	TM00673100	844144
26x9.00R12	8	TM00839100	844145
26x9.00R14	8	TM00854100	844146
27x9.00R14	8	TM00841100	844147

SIZES	PLY RATING	MFG #	PART #
25X10.00R12	8	TM00674100	844148
26x11.00R12	8	TM00840100	844149
26x11.00R14	8	TM00855100	844150
27x11.00R14	8	TM00842100	844151



CEROS

- Built for high-speed desert and short course racing, the Ceros features a directional, smooth-rolling tread pattern that provides steering precision and straight-line stability at high speeds.
- Frequent choice of SxS racing champions in Lucas Oil Off Road Racing Series
- Excellent traction and stability on hardpack or loose-over-hard conditions
- 6-ply-rated radial construction

SIZES	PLY RATING	MFG #	PART #
23X8.00R12	6	TM00293100	844154
25X8.00R12	6	TM00418100	844155
26X9.00R12	6	TM00242100	844156
29X9.00R14	6	TM00904100	844159



MAXXZILLA

- The Maxxzilla lets riders power right through mud and keep going via deep tread lugs, a complex angle arrangement, and a stepped, 3D pattern for outstanding traction.
- 6-ply-rated radial construction

SIZES	PLY RATING	MFG #	PART #
27X9.00-12	6	TM01055100	844169
27X11.00-12	6	TM01056100	844170
28X9.00-14	6	TM01054100	844171
28X11.00-14	6	TM01047100	844172



ZILLA

- With both superb mud traction and outstanding trail riding performance, the Zilla offers a winning combination. Available in front and rear, the Zilla is light and fast. The Zilla also has the largest available range of sizes in our Mud lineup.
- 6-ply-rated bias construction
- Recommended use: Mud and trail

SIZES	PLY RATING	MFG #	PART #
AT24X8-12	6	TM00451100	844065
AT25X8-12	6	TM00448100	844066
AT25X8-12	6	TM00449100	844067
AT26X9-12	6	TM00452100	844068
AT26X9-14	6	TM00454100	844069
AT27X10-14	6	TM00455100	844070
AT27X9-12	6	TM00456100	844071
AT28X10-12	6	TM00453100	844072
AT28X9-14	6	TM00344100	844073
AT30X9-14	6	TM00457100	844074

SIZES	PLY RATING	MFG #	PART #
AT25X10-12	6	TM00440100	844077
AT25X10-12	6	TM00438100	844078
AT26X11-12	6	TM00441100	844079
AT26X11-14	6	TM00444100	844080
AT27X11-12	6	TM00442100	844081
AT27X12-14	6	TM00445100	844082
AT28X11-14	6	TM00393100	844083
AT28X12-12	9	TM00443100	844084
AT30X11-14	6	TM00446100	844085





BEADLOCK WHEELS

A12-SQUAD

- Aggressive multi-spoke directional design with an internal rib for added style and strength
- Constructed out of heavy duty A356 aluminum with a forged 6061 beadlock ring with Grade 8 zinc beadlock hardware included
- Black-Out snap in cap with contrasting Raceline logo
- Available in Satin Black w/ Gunmetal Beadlock Ring and Hyper Silver w/ Satin Black Beadlock Ring
- Available in 15" for most UTV fitments
- Engineered to be one of the strongest wheels available
- The Official Wheel of Ultra 4 Racing, NORRA, MidAmerica Outdoors, Southern Rock Racing Series, Nor Cal Rock Racing and more



Satin Black - Gun Metal Ring Hyper Silver - Black Ring

SPECIFICATIONS

WHEEL PART #	WHEEL COLOR	RING COLOR	WHEEL SIZE	BOLT PATTERN	OFFSET	ATV OFFSET	LOAD RATING	CAP PART #	CAP MFG #
287005	HYPER SILVER	BLACK	15X7	4X137	10	5+2	1000	287256	CPR-A13B-156-ND
287006	HYPER SILVER	BLACK	15X7	4X137	38	6+1	1000	287256	CPR-A13B-156-ND
287007	HYPER SILVER	BLACK	15X7	4X156	10	5+2	1000	287256	CPR-A13B-156-ND
287008	HYPER SILVER	BLACK	15X7	4X156	38	6+1	1000	287256	CPR-A13B-156-ND
287001	SATIN BLACK	GUNMETAL	15X7	4X137	10	5+2	1000	287256	CPR-A13B-156-ND
287002	SATIN BLACK	GUNMETAL	15X7	4X137	38	6+1	1000	287256	CPR-A13B-156-ND
287003	SATIN BLACK	GUNMETAL	15X7	4X156	10	5+2	1000	287256	CPR-A13B-156-ND
287004	SATIN BLACK	GUNMETAL	15X7	4X156	38	6+1	1000	287256	CPR-A13B-156-ND

A14-ALPHA

- The new Raceline A14 Alpha beadlock wheel was designed exclusively for the new Can Am Maverick R, the Polaris RZR R in 5x114.3 bolt pattern and others. Its aggressive 12 scalloped spoke design with its contrasting beadlock ring gives it a true rally inspired race look
- Constructed out of heavy duty A356 aluminum with a forged 6061 beadlock ring with Grade 8 zinc beadlock hardware included
- Black-Out snap-in Raceline cap with contrasting red Pro Spec beadlock logos
- Available in Satin Black w/ Gunmetal Beadlock Ring, Gunmetal w/ Gloss Red Beadlock Ring and Hyper Silver w/ Black Beadlock Ring
- Available in 15x7, 15x10 and 17x7
- Engineered to be one of the strongest wheels available



Black - Gun Metal Ring



Gun Metal - Red Ring



Hyper Silver -Black Ring

SPECIFICATIONS

WHEEL PART #	WHEEL COLOR	RING COLOR	WHEEL SIZE	BOLT PATTERN	OFFSET	ATV OFFSET	LOAD RATING	CAP PART #	CAP MFG #
287020	BLACK	GUNMETAL	15X10	4X137	10	5+2	1650	287204	CPR-A14B-156
287021	BLACK	GUNMETAL	15X10	4X156	10	5+2	1650	287204	CPR-A14B-156
287019	BLACK	GUNMETAL	15X10	5X114.3	25	5+2	1650	287202	CPR-A14B-114.3
287022	BLACK	GUNMETAL	15X10	6X139.7	25	5+2	1650	287203	CPR-A14B-139.7
287023	BLACK	GUNMETAL	15X6.5	6X139.7	74	NA	1650	287203	CPR-A14B-139.7
287026	BLACK	GUNMETAL	15X7	4X137	10	5+2	1650	287204	CPR-A14B-156
287027	BLACK	GUNMETAL	15X7	4X156	10	5+2	1650	287204	CPR-A14B-156
287024	BLACK	GUNMETAL	15X7	5X114.3	25	5+2	1650	287202	CPR-A14B-114.3
287025	BLACK	GUNMETAL	15X7	5X114.3	53	6+1	1650	287202	CPR-A14B-114.3
287030	BLACK	GUNMETAL	17X7	4X137	25	5+2	1650	287204	CPR-A14B-156
287031	BLACK	GUNMETAL	17X7	4X137	40	6+1	1650	287204	CPR-A14B-156
287032	BLACK	GUNMETAL	17X7	4X156	25	5+2	1650	287204	CPR-A14B-156
287033	BLACK	GUNMETAL	17X7	4X156	40	6+1	1650	287203	CPR-A14B-156
287028	BLACK	GUNMETAL	17X7	5X114.3	25	5+2	1650	287202	CPR-A14B-114.3
287029	BLACK	GUNMETAL	17X7	5X114.3	40	6+1	1650	287202	CPR-A14B-114.3
287034	GUNMETAL	RED	15X10	5X114.3	25	6+4	1650	287205	CPR-A14G-114.3
287037	GUNMETAL	RED	15X7	4X137	10	5+2	1650	287206	CPR-A14G-156
287038	GUNMETAL	RED	15X7	4X137	10	5+2	1650	287206	CPR-A14G-156
287035	GUNMETAL	RED	15X7	5X114.3	25	5+2	1650	287205	CPR-A14G-114.3
287036	GUNMETAL	RED	15X7	5X114.3	53	6+1	1650	287205	CPR-A14G-114.3
287039	HYPER SILVER	BLACK OUTER	15X10	4X137	10	5+2	1650	287254	CPR-A14S-156
287040	HYPER SILVER	BLACK OUTER	15X10	4X156	10	5+2	1650	287254	CPR-A14S-156
287041	HYPER SILVER	BLACK OUTER	15X10	6X139.7	25	6+4	1650	287207	CPR-A14S-139.7
287042	HYPER SILVER	BLACK OUTER	15X6.5	6X139.7	74	NA	1650	287257	CPR-A14G-139.7
287043	HYPER SILVER	BLACK OUTER	15X7	4X137	10	5+2	1650	287254	CPR-A14S-156
287044	HYPER SILVER	BLACK OUTER	15X7	4X156	10	5+2	1650	287254	CPR-A14S-156
287047	HYPER SILVER	BLACK OUTER	17X7	4X137	25	5+2	1650	287254	CPR-A14S-156
287048	HYPER SILVER	BLACK OUTER	17X7	4X137	40	6+1	1650	287254	CPR-A14S-156
287049	HYPER SILVER	BLACK OUTER	17X7	4X156	25	5+2	1650	287254	CPR-A14S-156
287050	HYPER SILVER	BLACK OUTER	17X7	4X156	40	6+1	1650	287254	CPR-A14S-156
287045	HYPER SILVER	BLACK OUTER	17X7	5X114.3	25	5+2	1650	287258	CPR-A14S-114.3
287046	HYPER SILVER	BLACK OUTER	17X7	5X114.3	40	6+1	1650	287255	CPR-A14S-114.3

ATV/UTV BEADLOCK WHEELS

A17-MAMBA

- One of the first Raceline UTV beadlock designs, and one of the most popular.
- Constructed out of heavy duty A356 aluminum with a forged 6061 beadlock ring with US made Grade 8 zinc beadlock hardware included.
- UTV Beadlock Bolts = 1" length.
- Engineered to be one of the strongest wheels available

Black - Black Ring
Black - Machined Ring

SPECIFICATIONS									
WHEEL PART #	WHEEL COLOR	RING COLOR	WHEEL SIZE	BOLT PATTERN	OFFSET	ATV OFFSET	LOAD RATING	CAP PART #	CAP MFG #
287052	BLACK	BLACK	14X7	4X156	5	4+3	800	287208	CPR-A82-110
287053	BLACK	BLACK	14X8	4X137	0	4+4	800	287208	CPR-A82-110
287054	BLACK	BLACK	14X8	4X156	0	4+4	800	287208	CPR-A82-110
287055	BLACK	BLACK	15X7	4X137	0	3.5+3.5	1200	287210	CPR-A82-156
287056	BLACK	BLACK	15X7	4X156	0	3.5+3.5	1200	287210	CPR-A82-156
287057	BLACK	MACHINED	15X6	4X137	40	5+1	1200	287210	CPR-A82-156
287058	BLACK	MACHINED	15X6	4X156	40	5+1	1200	287210	CPR-A82-156

A91-RYNO

- Rugged split 10 spoke design with offset spokes gives the Ryno UTV a modern feel.
- Constructed out of heavy duty A356 aluminum with a forged 6061 beadlock ring with US made Grade 8 zinc beadlock hardware included.
- UTV Beadlock Bolts = 1" length.
- Includes a satin black snap-in cap with embossed chrome Raceline logo.
- Engineered to be one of the strongest wheels available.

Black - Black Ring
Gun Metal - Black Ring
Black Machined - Black Ring

SPECIFICATIONS									
WHEEL PART #	WHEEL COLOR	RING COLOR	WHEEL SIZE	BOLT PATTERN	OFFSET	ATV OFFSET	LOAD RATING	CAP PART #	CAP MFG #
287072	BLACK	BLACK	14X7	4X137	10	5+2	800	287210	CPR-A82-156
287073	BLACK	BLACK	14X7	4X156	10	5+2	800	287210	CPR-A82-156
287074	BLACK	BLACK	15X10	4X137	0	5+5	1000	287210	CPR-A82-156
287075	BLACK	BLACK	15X10	4X156	0	5+5	1000	287210	CPR-A82-156
287077	BLACK	BLACK	15X7	4X156	10	5+2	1000	287210	CPR-A82-156
287076	BLACK	BLACK	15X8	4X137	10	5+2	1000	287210	CPR-A82-156
287078	GUNMETAL	BLACK	14X7	4X137	10	5+2	800	287210	CPR-A82-156
287079	GUNMETAL	BLACK	14X7	4X156	10	5+2	800	287210	CPR-A82-156
287080	GUNMETAL	BLACK	15X10	4X137	0	5+5	1000	287210	CPR-A82-156
287081	GUNMETAL	BLACK	15X10	4X156	0	5+5	1000	287210	CPR-A82-156
287082	GUNMETAL	BLACK	15X7	4X137	10	5+2	1000	287210	CPR-A82-156
287083	GUNMETAL	BLACK	15X7	4X156	10	5+2	1000	287210	CPR-A82-156
287084	BLACK	MACHINED BLACK	14X7	4X137	10	5+2	800	287210	CPR-A82-156
287085	BLACK	MACHINED BLACK	14X7	4X156	10	5+2	800	287210	CPR-A82-156
287086	BLACK	MACHINED BLACK	15X10	4X137	0	5+5	1000	287210	CPR-A82-156
287087	BLACK	MACHINED BLACK	15X10	4X156	0	5+5	1000	287210	CPR-A82-156
287088	BLACK	MACHINED BLACK	15X7	4X137	10	5+2	1000	287210	CPR-A82-156
287089	BLACK	MACHINED BLACK	15X7	4X156	10	5+2	1000	287210	CPR-A82-156

A92-HOSTAGE

- 8 spoke dimpled design with a flush face contour
- Constructed out of heavy duty A356 aluminum with a reinforced lip and end milling for a subtle contrast.
- Engineered to be one of the strongest wheels available
- Includes a satin black snap-in cap with embossed chrome Raceline logo



Satin Black - Black Ring

SPECIFICATIONS									
WHEEL PART #	WHEEL COLOR	RING COLOR	WHEEL SIZE	BOLT PATTERN	OFFSET	ATV OFFSET	LOAD RATING	CAP PART #	CAP MFG #
287090	SATIN BLACK	BLACK	12X7	4X110	10	5+2	800	287208	CPR-A82-110
287091	SATIN BLACK	BLACK	14X7	4X110	-47	2+5	800	287208	CPR-A82-110
287092	SATIN BLACK	BLACK	14X7	4X110	10	5+2	800	287208	CPR-A82-110
287093	SATIN BLACK	BLACK	14X7	4X137	10	5+2	800	287210	CPR-A82-156
287094	SATIN BLACK	BLACK	14X7	4X156	5	4+3	800	287210	CPR-A82-156

A93-PODIUM

- Iconic 8 spoke mesh style design.
- Constructed out of heavy duty A356 aluminum with a forged 6061 beadlock ring with US made Grade 8 zinc beadlock hardware included.
- UTV Beadlock Bolts = 1" length.
- Engineered to be one of the strongest wheels available.
- Includes a satin black snap-in cap with embossed chrome Raceline logo.



Satin Black - Black Ring

Stealth Grey

SPECIFICATIONS								
WHEEL PART #	WHEEL COLOR	RING COLOR	WHEEL SIZE	BOLT PATTERN	OFFSET	LOAD RATING	CAP PART #	CAP MFG #
287095	BLACK	BLACK	14X7	4X137	10	1200	287208	CPR-A82-110
287096	BLACK	BLACK	14X7	4X156	10	1200	287210	CPR-A82-156
287097	BLACK	BLACK	15X6	4X137	40	1200	287210	CPR-A82-156
287098	BLACK	BLACK	15X6	4X156	40	1200	287210	CPR-A82-156
287099	STEALTH GREY	BLACK	14X7	4X156	10	1200	287208	CPR-A82-156
287100	STEALTH GREY	BLACK	15X6	4X137	40	1200	287210	CPR-A82-156
287101	STEALTH GREY	BLACK	15X6	4X156	40	1200	287210	CPR-A82-156



ATV/UTV NON-BEADLOCK WHEELS

NON-BEADLOCK WHEELS

A13-OMEGA

- Classic yet aggressive mesh spoke design with an ultraclean retro inspired lip.
- Constructed out of heavy duty A356 aluminum.
- Black-Out snap in cap with contrasting Raceline logo available in multiple colors that can be matched with lip treatment logos (all colors included with each wheel).
- Engineered to be one of the strongest wheels available.



Gloss Black

Satin Black

SPECIFICATIONS

WHEEL PART #	WHEEL COLOR	WHEEL SIZE	BOLT PATTERN	OFFSET	ATV OFFSET	LOAD RATING	CAP PART #	CAP MFG #
287015	GLOSS BLACK	15X10	4X137	0	5+5	1000	287256	CPR-A13B-156-ND
287016	GLOSS BLACK	15X10	4X156	0	5+5	1000	287256	CPR-A13B-156-ND
287017	GLOSS BLACK	15X7	4X137	10	5+2	1000	287256	CPR-A13B-156-ND
287018	GLOSS BLACK	15X7	4X156	10	5+2	1000	287256	CPR-A13B-156-ND
287009	SATIN BLACK	14X7	4X137	10	5+2	1000	287256	CPR-A13B-156-ND
287010	SATIN BLACK	14X7	4X156	10	5+2	1000	287256	CPR-A13B-156-ND
287011	SATIN BLACK	15X10	4X137	0	5+5	1000	287256	CPR-A13B-156-ND
287012	SATIN BLACK	15X10	4X156	0	5+5	1000	287256	CPR-A13B-156-ND
287013	SATIN BLACK	15X7	4X137	10	5+2	1000	287256	CPR-A13B-156-ND
287014	SATIN BLACK	15X7	4X156	10	5+2	1000	287256	CPR-A13B-156-ND

A14-ALPHA V

- The new Raceline A14V Alpha non-beadlock wheel was designed exclusively for the new Polaris RZR R in 5x114.3 bolt pattern. Its aggressive 12 scalloped spoke design takes its cues from the recently released A14 . Alpha Beadlock but with an ultra clean lip.
- Constructed out of heavy duty A356 aluminum.
- • Black-Out snap-in Raceline cap with contrasting red Pro Spec beadlock logos.
- • Available in 15x7 exclusively for the Polaris Turbo R and Pro R.
- • Engineered to be one of the strongest wheels available.



Satin Black

SPECIFICATIONS

WHEEL PART #	WHEEL COLOR	WHEEL SIZE	BOLT PATTERN	OFFSET	ATV OFFSET	LOAD RATING	CAP PART #	CAP MFG #
287051	SATIN BLACK	15X7	5X114.3	56	N/A	1650	287211	CPR-V14B-114.3

A77-MAMBA

- One of the first Raceline UTV designs, and taking cues from Mamba HD for trucks, the Mamba UTV
- continues as one of the most popular styles ever.
- Constructed out of heavy duty A356 aluminum with a reinforced lip and end milling for a subtle contrast.
- Includes a satin black snap-in cap with embossed chrome Raceline logo.



Black Machined/machined

SPECIFICATIONS								
WHEEL PART #	WHEEL COLOR	WHEEL SIZE	BOLT PATTERN	OFFSET	ATV OFFSET	LOAD RATING	CAP PART #	CAP MFG #
287059	BLACK MACHINED	10X5	4X144	18	3+2	350	287255	CPR-A82-110T
287060	BLACK MACHINED	10X5	4X156	18	3+2	350	287255	CPR-A82-110T
287061	BLACK MACHINED	12X7	4X110	10	5+2	700	287208	CPR-A82-110
287062	BLACK MACHINED	12X7	4X156	5	4+3	700	287208	CPR-A82-110
287063	BLACK MACHINED	14X7	4X110	-47	2+5	800	287208	CPR-A82-110
287064	BLACK MACHINED	14X7	4X110	10	5+2	800	287208	CPR-A82-110
287065	BLACK MACHINED	14X7	4X115	10	5+2	800	287208	CPR-A82-110
287066	BLACK MACHINED	14X7	4X137	10	5+2	800	287208	CPR-A82-110
287067	BLACK MACHINED	14X7	4X156	5	4+3	800	287208	CPR-A82-110
287068	BLACK MACHINED	15X7	4X137	10	5+2	800	287208	CPR-A82-110
287069	BLACK MACHINED	15X7	4X156	5	4+3	800	287208	CPR-A82-110
287070	BLACK MACHINED	9X8	4X110	-34.5	3+5	350	287255	CPR-A82-110T
287071	BLACK MACHINED	9X8	4X115	-34.5	3+5	350	287255	CPR-A82-110T

A94-KRANK

- 8 split V-spoke design
- Constructed out of heavy duty A356 aluminum with a simulated beadlock ring area finished off with stainless steel bolts
- Engineered to be one of the strongest wheels available
- Includes a satin black snap-in cap with embossed chrome Raceline logo



Black Bronze Red

SPECIFICATIONS								
WHEEL PART #	WHEEL COLOR	WHEEL SIZE	BOLT PATTERN	OFFSET	ATV OFFSET	LOAD RATING	CAP PART #	CAP MFG #
287103	BLACK	14X7	4X137	10	5+2	1000	287210	CPR-A82-156
287104	BLACK	14X7	4X137	38	6+1	1000	287210	CPR-A82-156
287105	BLACK	14X7	4X156	10	5+2	1000	287210	CPR-A82-156
287106	BLACK	14X7	4X156	38	6+1	1000	287210	CPR-A82-156
287107	BLACK	15X7	4X137	10	5+2	1000	287210	CPR-A82-156
287108	BLACK	15X7	4X156	10	5+2	1000	287210	CPR-A82-156
287109	BRONZE	14X7	4X110	10	5+2	1000	287208	CPR-A82-110
287110	BRONZE	14X7	4X137	10	5+2	1000	287210	CPR-A82-156
287111	BRONZE	14X7	4X137	38	6+1	1000	287210	CPR-A82-156
287112	BRONZE	14X7	4X156	10	5+2	1000	287210	CPR-A82-156
287113	BRONZE	14X7	4X156	38	6+1	1000	287210	CPR-A82-156
287114	BRONZE	15X7	4X137	10	5+2	1000	287210	CPR-A82-156
287115	BRONZE	15X7	4X156	10	5+2	1000	287210	CPR-A82-156
287116	RED	14X7	4X110	10	5+2	1000	287208	CPR-A82-110
287117	RED	14X7	4X137	10	5+2	1000	287210	CPR-A82-156
287118	RED	14X7	4X156	10	5+2	1000	287210	CPR-A82-156
287119	RED	14X7	4X156	38	6+1	1000	287210	CPR-A82-156
287120	RED	15X7	4X137	10	5+2	1000	287210	CPR-A82-156
287121	RED	15X7	4X156	10	5+2	1000	287210	CPR-A82-156

ATV/UTV NON-BEADLOCK WHEELS

A95-TROPHY

- Strong 10 spoke design, the UTV version of the 934 Clutch for trucks.
- Constructed out of heavy duty A356 aluminum with a simulated beadlock ring area finished off with stainless steel bolts.
- Engineered to be one of the strongest wheels available.
- Includes a satin black snap-in cap with embossed chrome Raceline logo



Black

Stealth Grey

SPECIFICATIONS								
WHEEL PART #	WHEEL COLOR	WHEEL SIZE	BOLT PATTERN	OFFSET	ATV OFFSET	LOAD RATING	CAP PART #	CAP MFG #
287122	BLACK	14X7	4X110	10	5+2	1000	287208	CPR-A82-110
287123	BLACK	14X7	4X137	10	5+2	1000	287210	CPR-A82-156
287124	BLACK	14X7	4X137	38	6+1	1000	287210	CPR-A82-156
287125	BLACK	14X7	4X156	10	5+2	1000	287210	CPR-A82-156
287126	BLACK	14X7	4X156	38	6+1	1000	287210	CPR-A82-156
287127	BLACK	15X6	4X137	40	5+1	1000	287210	CPR-A82-156
287128	BLACK	15X6	4X156	40	5+1	1000	287210	CPR-A82-156
287129	BLACK	15X7	4X137	10	5+2	1000	287210	CPR-A82-156
287130	BLACK	15X7	4X156	10	5+2	1000	287210	CPR-A82-156
287131	STEALTH GREY	14X7	4X110	10	5+2	1000	287208	CPR-A82-110
287132	STEALTH GREY	14X7	4X137	10	5+2	1000	287210	CPR-A82-156
287133	STEALTH GREY	14X7	4X156	10	5+2	1000	287210	CPR-A82-156
287134	STEALTH GREY	15X6	4X156	40	5+1	1000	287210	CPR-A82-156
287135	STEALTH GREY	15X7	4X137	10	5+2	1000	287210	CPR-A82-156
287136	STEALTH GREY	15X7	4X156	10	5+2	1000	287210	CPR-A82-156



LUG NUTS

SPLINE CS PACK W/KEY)

- Includes 16 Lugs for ATV/UTV



SPECIFICATIONS			
SIZES	QUANTITY	MFG #	PART #
BLACK			
3/8" x 24 Conical	16 Pack	RLUG-BX13B	287240
10mm x 1.25 Conical	16 Pack	RLUG-BX14B	287242
1/2" x 20 Splined	16 Pack	RLUG-CS120B	287246
12mm x 1.25 Splined	16 Pack	RLUG-CS19B	287248
12mm x 1.50 Splined	16 Pack	RLUG-CS20B	287250
12mm x 1.50 Splined	20 Pack	RLUG-CS25B	287252
CHROME			
3/8" x 24 Conical	16 Pack	RLUG-BX13C	287241
10mm x 1.25 Conical	16 Pack	RLUG-BX14C	287243
10mm x 1.25 Flat	16 Pack	RLUG-BX15C	287244
10mm x 1.25 Flat	16 Pack	RLUG-BX16C	287245
1/2" x 20 Splined	16 Pack	RLUG-CS120C	287247
12mm x 1.25 Splined	16 Pack	RLUG-CS19C	287249
12mm x 1.50 Splined	16 Pack	RLUG-CS20C	287251

RACELINE UTV CAP

ONE WHEEL CAP INCLUDED IN EACH WHEEL BOX



SPECIFICATIONS		
SIZES	MFG #	PART #
CPR-A13B-156D 4X137/156	CPR-A13B-156D	287200
CPR-A13GB-156D 4X137/156	CPR-A13GB-156D	287201
UTV CAP FITS 5X114.3 BLACK	CPR-A14B-114.3	287202
UTV CAP FITS 6X139.7 BLACK	CPR-A14B-139.7	287203
UTV CAP FITS 4X137/156 BLACK	CPR-A14B-156	287204
UTV CAP FITS 5X114.3 GUNMETAL	CPR-A14G-114.3	287205
UTV CAP FITS 4X137/156 GUNMETAL	CPR-A14G-156	287206
UTV CAP FITS 6X139.7 SILVER	CPR-A14S-139.7	287207
ATV CAP FITS 4X110 & 4X115 ATV WHEELS	CPR-A82-110	287208
1" SPACER FOR CPR-A82-110	CPR-A82-110-S	287209
ATV CAP FITS 4X137 & 4X156 ATV WHEELS	CPR-A82-156	287210
UTV CAP FITS V14B 5X114.3 BLACK	CPR-V14B-114.3	287211



A13 OMEGA WHEEL DECAL PACK

- Designed for the A13B and A13GB Omega UTV Wheel
- Includes (2) lip decals, (1) center cap decal in red, black, blue and grey

SPECIFICATIONS		
DESCRIPTION	MFG #	PART #
2 LIP DECALS 1 CAP DECAL	D-A13-PACK	287212



A14 ALPHA WHEEL BLACK DECAL PACK

- Designed for the UTV Wheel A14 15", and 17" Beadlock Ring
- Includes (8) black lip decals

SPECIFICATIONS		
SIZES	MFG #	PART #
15"BDLK RING DECAL(47.8MM)BLK 8PACK	DECAL-A14B	287213
17"BDLK RING DECAL(36.8MM)BLK 8PACK	DECAL-A14B-17"	287214
15"BDLK RING DECAL(47.8MM)RED 8PACK	DECAL-A14R	287215



UTV A71 MAMBA BEADLOCK RINGS

- 12" POLISHED BL RING 16 HOLE 8mm
- Light Weight Exposed Bolt Heads

SPECIFICATIONS		
SIZES	MFG #	PART #
12" POLISHED BL RING 16 HOLE 8MM	RBL-12P-A71-RING-16	287216
14" POLISHED BL RING 20 HOLE 8MM	RBL-14P-A71-RING-20	287220
15" POLISHED BL RING 20 HOLE 8MM	RBL-15P-A71-RING-20	287231

UTV A71 MAMBA BEADLOCK RINGS

- 12" POLISHED BL RING 16 HOLE 8mm
- Light Weight Exposed Bolt Heads



SPECIFICATIONS		
SIZES	MFG #	PART #
14" BLACK BL RING 20 HOLE 8MM	RBL-14B-A71-RING-20	287217
14" BLACK BL RING 20 HOLE 12MM	RBL-14B-A91-RING-20	287218
14" BLACK BL RING 16 HOLE PODIUM 10MM	RBL-14B-A93-RING-16	287219
15" BLACK BL RING 16 HOLE 12MM W/BLK DECAL	RBL-15B-A14-RING-16	287224
15" BLACK BL RING 20 HOLE 8MM	RBL-15B-A71-RING-20	287225
15" BLACK BL RING 20 HOLE 12MM	RBL-15B-A91-RING-20	287226
15" BLACK BL RING 16 HOLE RING FOR PODIUM 10MM	RBL-15B-A93-RING-16	287227
15" BLACK BL RING 20 HOLE W/RACELINE LOGO 16MM	RBL-15B-RTD-RING-20	287228
17" BLACK BL RING 24 HOLE 12MM W/BLK DECAL	RBL-17B-A14-RING-24	287237

UTV RED - A91 RYNO BEADLOCK RINGS

- 14" RED BL RING 16 and 20 HOLE RING 12mm
- 12mm Thick



SPECIFICATIONS		
SIZES	MFG #	PART #
14" RED BL RING 20 HOLE RING 12MM	RBL-14R-A91-RING-20	287221
14" RED BL RING 16 HOLE RING PODIUM 10MM	RBL-14R-A93-RING-16	287222
15" RED BL RING 16 HOLE 12MM W/ RED DECAL	RBL-15R-A14-RING-16	287232
15" RED BL RING 20 HOLE RING 12MM	RBL-15R-A91-RING-20	287233
15" RED BL RING 16 HOLE FOR PODIUM 10MM	RBL-15R-A93-RING-16	287234

RBL SPACER UTV SPACER

- Beadlock Plastic Spacers INCLUDES 4 PIECES TO COMPLETE ONE UTV WHEEL
- SPACER KIT FOR 20 HOLE UTV BEADLOCK RING 1/8" (4pcs.)
- NOTE: YOU WILL NEED TO PURCHASE 4 KITS IF YOU ARE REPLACING FOR A COMPLETE SET



SPECIFICATIONS		
DESCRIPTION/SIZES	MFG #	PART #
14" SPACER KIT FOR 20 HOLE UTV BEADLOCK RING 1/8" (4PCS.)	RBL14-SPACER	287223
15" SPACER KIT FOR 20 HOLE UTV BEADLOCK RING 1/8" (4PCS.)	RBL15-UTVSPACER	287235
15" SPACER KIT FOR 16 HOLE UTV BEADLOCK RING 1/8" (4PCS.)	RBL15-UTVSPACER-16H	287236



RACELINE BEADLOCK RING

SPECIFICATIONS		
SIZES	MFG #	PART #
15" GUNMETAL BL RING 16 HOLE 12MM W/ RED DECAL	RBL-15G-A14-RING-16	287229
15" GUNMETAL BL RING 16 HOLE FOR PODIUM 10MM	RBL-15G-A93-RING-16	287230
17" GUNMETAL BL RING 24 HOLE 12MM W/RED DECAL	RBL-17G-A14-RING-24	287238



RBL-BOLT1" 20PCS. KIT

- 5/16-18 X 1.00" GRADE 8 BEADLOCK BOLT KIT 20 PCS. +2 EXTRA BOLTS

SPECIFICATIONS		
SIZES	MFG #	PART #
5/16-18 X 1.00" GRADE 8 BEADLOCK BOLT KIT 20 PCS. +2 EXTRA BOL	RBL-BOLT1" 20PCS. KIT	287239



RACELINE WHEELS CENTER CAPS

SPECIFICATIONS		
SIZES	MFG #	PART #
RACELINE CENTERCAP	CPR-A14S-156	287254
RACELINE UTV CENER CAP	CPR-A82-110T	287255
RACELINE CENER CAP	CPR-A13B-156-ND	287256
RACELINE UTV CENER CAP	CPR-A14G-139.7	287257
RACELINE UTV CENER CAP	CPR-A14S-114.3	287258



FAST SAME DAY SHIPPING

TRAILER

TABLE OF CONTENTS

Automatic Distributor	155
Carlisle	155
Kenda	156-159



CARLISLE 42116 530X12 C T&W 4 HOLE PAINTED WHITE SPOKED

The Carlisle 42116 530x12 C T&W 4-Hole Painted White Spoked Wheel is a high-quality trailer wheel and tire assembly designed for durability and style.

TIRE SIZE	LOAD RANGE	MAX LOAD CAPACITY @ PSI	MFG #	PART #
530X12	C	1045 @ 80	42116	691032

AUTOMATIC DISTRIBUTORS

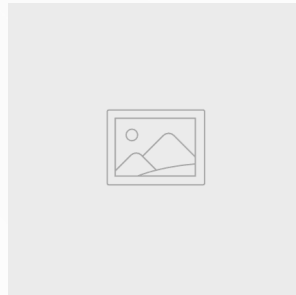

UNIVERSAL GROUP TRAILER WHEEL HUB KITS

- High quality 1.5mm thick butyl tube pre-loaded with Counteract Balancing Beads
- Balanced for the life of the tire
- Extend tire life, even tread wear, increases horsepower due to decreased rolling resistance
- Provides the smoothest and most efficient ride possible
- No need for unsightly wheel weights or a tire balancer
- Cost effective
- Will not void tire warranties

SIZES	HUB	ITEM NUMBER	PART #
1-1/16" 1.5" SEAL L.P	4BOLT	-	230060
1-1/16" 1.5" SEAL L.P	5BOLT	-	230061
1"	4HOLE	1-100-04-05	HSH4
1-1/16"	4HOLE	IN HOUSE	HSH46
1"	5HOLE	1-150-04-04	HSH5
1" - SHORT	5HOLE	1-150A-04-02	HSH525
1-3/8 TO 1-1/16" TAPERED	5HOLE	1-1000-04-01	HSH545
1-1/16"	5HOLE	IN HOUSE	HSH56

AUTOMATIC DISTRIBUTORS

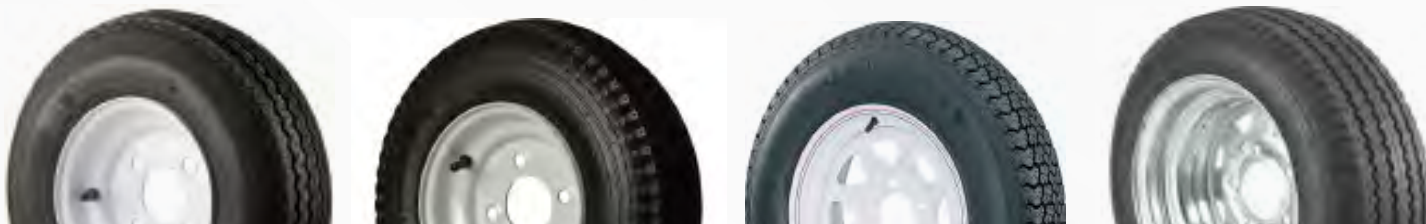

TIRE SIZE	HOLES	LOAD RANGE	RIM COLOR	MAXIMUM LOAD CAPACITY LBS @ PSI	MFG #	PART #
TIRE AND WHEEL ASSEMBLIES						
480X8	4	B	WHITE	590 @ 60	30000	698102
480X8	5	B	WHITE	590 @ 60	30020	698142
480X8	4	C	GALVANIZED	745 @ 90	30050	698204
480X8	5	C	GALVANIZED	745 @ 90	30070	698245
570X8	4	B	WHITE	715 @ 50	30080	698104
570X8	5	B	WHITE	715 @ 50	30100	698144
570X8	4	C	GALVANIZED	910 @ 75	30130	698208
570X8	5	C	GALVANIZED	910 @ 75	30150	698248
480X12	4	B	WHITE	780 @ 60	30540	698126
480X12	5	B	WHITE	780 @ 60	30580	698166
480X12	4	C	GALVANIZED	990 @ 90	30630	698174
205/65	4	C	WHITE	1520 @ 90	3H380	698294
480X12	5	C	GALVANIZED	990 @ 90	30670	698175
530X12	4	B	WHITE	840 @ 55	30700	698130
530X12	5	B	WHITE	840 @ 55	30740	698170
530X12	4	C	WHITE	1045 @ 80	30780	698172
530X12	5	C	WHITE	1045 @ 80	30820	698173
530X12	4	C	GALVANIZED	1045 @ 80	30790	698178
530X12	5	C	GALVANIZED	1045 @ 80	30850	698179
PNEUMATIC TIRE						
ST175/80DX13	5	C	WHITE	1360 @ 50	3S140	698190
ST175/80R/X13	5	D	GALVANIZED	1,650 @ 70	31985	698185
ST225/75DX15	5	C	GALVANIZED	2050 @ 50	3S760	698203
ST175/80DX13	5	C	GALVANIZED	1360 @ 50	3S160	698200
ST205/75DX14	5	C	WHITE	1760 @ 50	3S440	698191
ST215/75DX14	5	C	WHITE	1870 @ 50	3S550	698192
ST215/75DX14	5	C	GALVANIZED	1870 @ 50	3S560	698202
ST205/75DX15	5	C	WHITE	1820 @ 50	3S640	698193
ST205/75DX15	5	C	GALVANIZED	1820 @ 50	3S650	698201
RADIAL TIRE						
ST175/80RX13	5	C	GALVANIZED	1360 @ 50	S1952	698091
ST205/75RX14	5	C	GALVANIZED	1760 @ 50	S2156	698092
ST205/75RX15	5	C	GALVANIZED	1820 @ 50	S2397	698093
ST225/75RX15	6	C	WHITE	2150 @ 50	S2508	698196

Load star provides a wide range of trailer tires designed to run cooler and longer, reduce rolling resistance and increase durability.



TIRE SIZE	LOAD RANGE	MAX LOAD CAPACITY @ PSI	MFG #	PART #
LOAD STAR TIRE ONLY				
480X8	B	590 @ 60	10002	698002
570X8	B	715 @ 50	10010	698004
570X8	C	910 @ 75	10012	698006
480X12	B	780 @ 60	10060	698028
530X12	B	840 @ 55	10064	698030
ST175/80DX13	C	1360 @ 50	1ST76	698090
ST205/75DX14	C	1760 @ 50	1ST86	698095
ST215/75DX14	C	1820 @ 50	1ST90	698096
ST205/75DX15	C	1870 @ 50	1ST92	698097
215/60X8	C	940 @ 50	1HP26	698252
205/65X10	C	1105 @ 50	1HP52	698254
205/65X10	D	1270 @ 50	1HP54	698256





TIRE SIZE	HOLES	LOAD RANGE	RIM COLOR	MAXIMUM LOAD CAPACITY LBS @ PSI	MFG #	PART #
TIRE AND WHEEL ASSEMBLIES						
215/60X8	4	B	WHITE	770 @ 35	3H250	698260
215/60X8	5	B	WHITE	770 @ 35	3H270	698262
215/60X8	4	C	WHITE	940 @ 50	3H290	698264
215/60X8	5	C	WHITE	940 @ 50	3H310	698266
215/60X8	4	B	GALVANIZED	770 @ 35	3H260	698270
215/60X8	5	B	GALVANIZED	770 @ 35	3H280	698272
215/60X8	4	C	GALVANIZED	940 @ 50	3H300	698274
215/60X8	5	C	GALVANIZED	940 @ 50	3H320	698276
215/60X8	4	C	SILVER	940 @ 50	3H292	698300
215/60X8	5	C	SILVER	940 @ 50	3H312	698302
205/65X10	4	B	WHITE	905 @ 35	3H330	698280
205/65X10	5	B	WHITE	905 @ 35	3H350	698282
205/65X10	4	C	WHITE	1105 @ 50	3H370	698284
205/65X10	5	C	WHITE	1105 @ 50	3H390	698286
205/65X10	4	B	GALVANIZED	905 @ 35	3H340	698290
205/65X10	5	B	GALVANIZED	905 @ 35	3H360	698292
205/65X10	5	C	GALVANIZED	1105 @ 50	3H400	698296
205/65X10	5	D	GALVANIZED	1330 @ 50	3H440	698298
205/65X10	4	C	SILVER	1105 @ 50	3H371	698310
205/65X10	5	C	SILVER	1105 @ 50	3H394	698312
205/65X10	5	D	SILVER	1330 @ 50	3H432	698320
205/65X10	5	E	SILVER	1535 @ 50	3H482	698324



Wheel Torque Chart	Stud Size	LBS/FT
	1/2" -20	70-90
Standard Wheels	9/16" -18	110-140
	5/8" -18	125-140

Bolt pattern is measured through center bolt circle

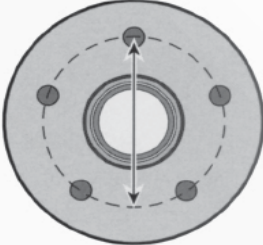



TRACKS

TABLE OF CONTENTS

Camso 160-175

AUTOMATIC
DISTRIBUTORS

HACKSAW TRAIL TRACK

The Hacksaw track is a Rip Saw derivative featuring crescent shaped profiles with recessed tips and cutting edges for hard packed snow. Excellent handling characteristics.



SIZES	PART #
15" X 121" - 1" (9043H)	403400
15" X 136" - 1" (9010H)	408300
14" X 128" - 1" (9110H)	408322
15" X 128" - 1" (9234H)	408541
15" X 121" - 1" (9043H144)	408655

CHALLENGER MOUNTAIN TRACK

The Benchmark of Mountain Tracks Proven Powder Performance for a Wide Range of Mountain Snow Conditions Length: 146" Width: 16" Lug Height: 2.313" Weight: 49 Lbs Clip Configuration: Full Construction: 1-Ply Drive Pitch: 2.86" Application: Mountain Please Note: 15" Track Can Be Used. Please Note: Not All Tracks Can Be Installed on All Sleds Without Modification.

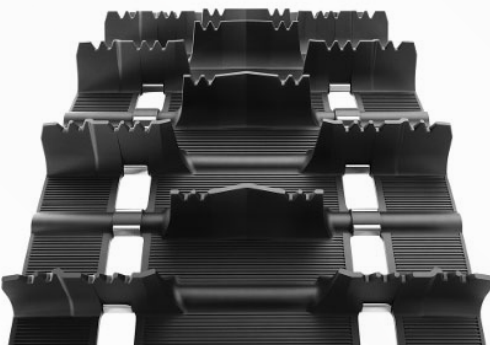

SIZES	PART #
16" X 146" - 2.313" (9064M)	408258
16" X 154" - 2.313" (9065M)	408259
16" X 146" - 2" (9187M)	408282
16" X 154" - 2" (9188M)	408283
15" X 144" - 2" (9875M)	408287
15" X 151" - 2" (9876M)	408472
16" X 137" - 2.313" (9204M)	408523

CHALLENGER EXTREME MTN. TRACK

Challenge the mountain in all snow types. Stems from the same design as the classic Challenger but adds even higher saw-tooth lugs that, while versatile, make boondocking bottomless powder and climbing the steepest chutes seem easy.



SIZES	PART #
16" X 154" - 2.5" (9102M)	408264
15" X 154" - 2.5" (9104M)	408266
15" X 163" - 2.5" (9105M)	408267
16" X 146" - 2.5" (9144M)	408270
15" X 146" - 2.5" (9145M)	408271
15" X 153" - 2.5" (9174M)	408272
15" X 162" - 2.5" (9175M)	408273
16" X 162" - 2.5" (9176M)	408274
15" X 141" - 2.5" (9329M)	408595



RIPSAW TRAIL TRACK

One of the best sellers offered, with rigid, hard-wearing lugs for mile after mile of dependable use. A wide range of sizes fits many different snowmobiles. This is the benchmark model for high-performance trail tracks, with excellent durability and traction on groomed or hard-pack snow.

SIZES	PART #
15" X 144" - 1.25" (9006H)	408297
15" X 151" - 1.25" (9007H)	408298
15" X 128" - 1.25" (9040H)	408305
15" X 120" - 1.25" (9149H)	408331
15" X 121" - 1.25" (9968H144)	408347
15" X 121" - 1.25"	9968H
15" X 136" - 1.25"	9969H



ICE ATTAK TRAIL TRACK

- Ice Attak is part of the Ice Control Enhancement Technology (ICE Tech) series of snowmobile tracks
- Comes factory pre-studded which results in improved traction
- Has a HackSaw derivative lug design for good top speed and handling on hard-packed snow
- Stud pattern features 31 separate traction points
- Weight is approximately 38 pounds

SIZES	PART #
15" X 121" - 1.0625" (9028H)	408302
15" X 136" - 1.0625" (9029H)	408303



ICE ATTAK XT TRAIL TRACK

A high-performance trail track designed for aggressive trail riders. Featuring hundreds of sharp-tip lug studs, it delivers unbeatable traction and control, giving you the confidence to tackle even the most challenging trails with ease.

SIZES	PART #
15" X 120" - 1.22" (9190H)	408336
15" X 137" - 1.22" (9191H)	408337
15" X 121" - 1.22" (9200H)	408338
15" X 128" - 1.22" (9201H)	408339
15" X 136" - 1.22" (9202H)	408340
15" X 144" - 1.22" (9203H)	408341
15" X 129" - 1.22" (9236H)	408543

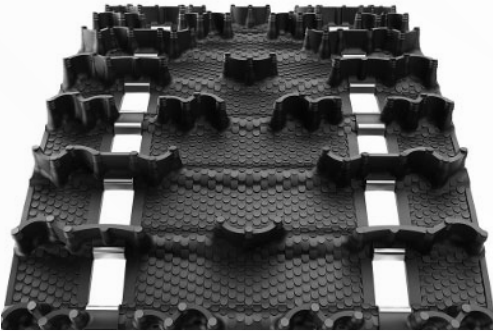

COBRA TRAIL TRACK

One of the top-selling snowmobile tracks, engineered for mile-after-mile reliability. Its rigid, hard-wearing lugs deliver exceptional durability and traction on groomed and hard-packed trails, while the wide range of sizes ensures a perfect fit for most snowmobile models.

SIZES	PART #
15" X 136" - 1.352" (9061H)	408311
15" X 129" - 1.352" (9235H)	408542
15" X 137" - 1.352" (9307H)	408558
15" X 120" - 1.352" (9284H)	408572
15" X 121" - 1.352"	9052H



CARVE TRAIL TRACK

Rip Saw Derivative featuring crescent profiles with recessed tips, cutting edges and superior handling for hard-packed snow

These tracks deliver outstanding traction, rock-solid handling and exceptional braking

SIZE	PART #
15" X 121" - 1" (9837H)	408342

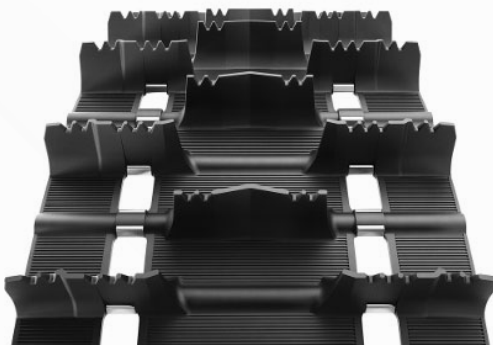

CROSSOVER CROSS COUNTRY TRACK

A popular 1.5" lug height track model for upgrading a range of segments including utility, touring and on/off-trail riding styles. The aggressive traction is perfect for crossover riders who prefer on-trail riding.

- Angled lugs offer outstanding forward and lateral bite on groomed trails
- Stepped lug design for greater flex and improved traction in soft, loose snow
- Available in greater lengths (144", 151" & 159") for conversion of mountain designed snowmobiles for on/off-trail riding

SIZES	PART #
15" X 144" - 1.5" (9003C)	408350
15" X 151" - 1.5" (9004C)	408351
15" X 159" - 1.5" (9005C)	408352

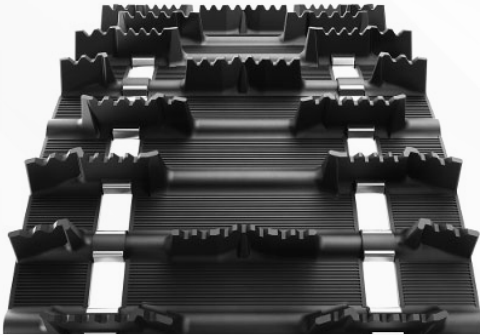

INTENSE CROSS COUNTRY TRACK

Off trail means rough riding. You need a tough track with extra traction for ditch line running, boondocking, and cross-country racing in deep snow and unprepared or non-maintained conditions. Give your crossover or trail sled a big performance boost where it really counts with a Camso cross country track.

SIZE	PART #
15" X 136" - 1.5" (9108C)	408359
15" X 121" - 1.5" (9930C)	408373

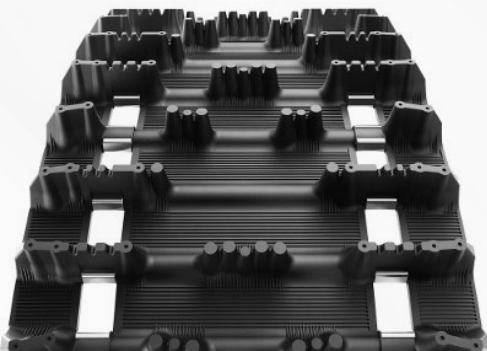

FREERIDE CROSS COUNTRY TRACK

Off trail means rough riding. You need a tough track with extra traction for ditch line running, boondocking, and cross-country racing in deep snow and unprepared or non-maintained conditions. Give your crossover or trail sled a big performance boost where it really counts with a Camso cross country track.

SIZE	PART #
14" X 121" - 1.5" (9033C)	408353



CHALLENGER TRL X-CNTRY TRACK

The go-to track for outstanding deep-snow performance since the mid-90s. As an all-around performer that's both versatile and durable, it delivers off-trail capability without sacrificing trail performance.

- Saw-tooth-tipped lugs provide excellent handling, acceleration, and braking on packed trails
- 16" width enhances flotation off-trail in soft snow

SIZE	PART #
16" X 137" - 1.75" (9070C)	408356



DURASPORT 530 TRAIL TRACK

Classic design with Camso durability and reliability built in. Features a good blend of performance, acceleration, and braking capabilities. The perfect upgrade or OEM replacement option. Dura Sport 530 model is an economical replacement track for older Ski-Doo model snowmobiles.

SIZES	PART #
15" X 114" - 0.53" (9755T)	408377
15" X 114" - 0.53" (9756T)	408378



DURASPORT 725 TRAIL TRACK

Economical, aggressive and durable full-block profile track. For long-haul touring riders, 100miles in a day is just a trip around the block. These tracks deliver commendable acceleration and braking as well as superior longevity.

SIZES	PART #
15" X 136" - 0.725" (9783T)	408379
15" X 116" - 0.725" (9796T)	408384





RIPSAW FULL UTILITY TRACK

A modified version of the tried-and-tested RipSaw design. Ideal for utility use, it features a full lug design and its 1.25" lug height is a popular upgrade for utility vehicles fitted with 1" lug tracks

SIZES	PART #
20" X 156" - 1.25" (9002U)	408386
20" X 154" - 1.375" (9089U)	408389
20" X 156" - 1.25" (9151U)	408390



RIPSAW II TRAIL TRACK

Put the power you have on the snow, not out under the snow flap. Don't void your warranty coverage with engine modifications when a track upgrade will make better use of the power you already have and retain your warranty protection. No matter it's age, give your performance sled more go on the snow with a Camso high performance trail track.

SIZES	PART #
15" X 120" - 1.25" (9209H)	408528
15" X 121" - 1.25" (9214H)	408530
15" X 136" - 1.25" (9216H)	408531
15" X 137" - 1.25" (9223H)	408534
15" X 137" - 1" (9224H)	408535
15" X 129" - 1.25" (9237H)	408544
15" X 128" - 1.25" (9215H)	408564



RIPSAW II 1.5 X-CNTRY TRACK

The RipSaw II, known for its versatility in all snow types, is taken to another level. Now boasting a 1.5-inch lug height, it's the track for the most demanding 50/50 rider.

- Sharp angled lugs provide excellent bite on hard-pack snow
- Cupped center and full outer lugs provide traction on loose, less compacted snow
- Tapered outside lug edges offer less side bite when cornering

SIZES	PART #
15" X 120" - 1.5" (9304C)	408580
15" X 129" - 1.5" (9305C)	408581
15" X 137" - 1.5" (9306C)	408582

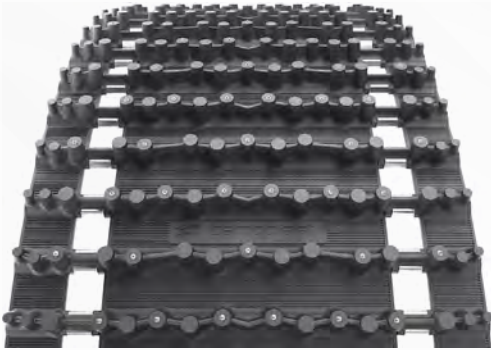

ICE WIDETRACK UTILITY TRACK

Utility sleds need unbeatable flotation and superb reliability to handle the toughest jobs. Featuring extra lateral stability and traction, this track is the only model in the category with a factory pre-studded design for utility snowmobiles using a 20" wide track.

SIZE	PART #
20" X 156" - 1.25" (9008U)	408387



ASPHALT DRAG RACING TRK

Engineered and built for the unique performance requirements of asphalt drag competitions, where traction and super-fast acceleration are the name of the game.

- Lightweight 10.625" width for maximum top speed
- Soft outer rubber provides traction on paved surfaces
- Multiple lengths for a wide variety of race chassis

SIZES	PART #
10.625" X 121" - 0.625" (9895R)	408475
10.625" X 128" - 0.625" (9896R)	408476
10.625" X 136" - 0.625" (9897R)	408477



EXPLORE 725 UTILITY TRACK

- External drive for reliable replacement on utility-specific snowmobiles
- For utility sleds, the work must go on; Camoplast utility tracks deliver impressive traction, unbeatable flotation and superb reliability to handle the toughest jobs
- Offered in two profiles, two widths and two lug heights

SIZE	PART #
15" X 139" - 0.725" (9011U)	408397

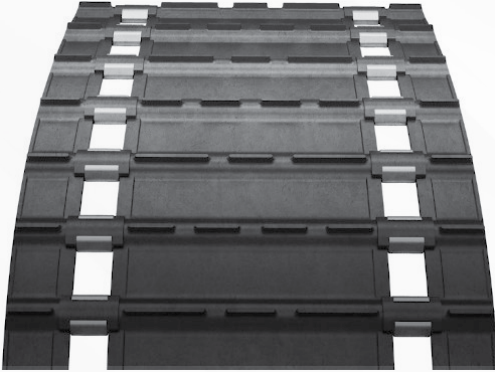

ICE OVAL/LEMANS RACING TRK

High-performance design engineered for the extreme cornering and acceleration of oval racing. A favorite among racers, it delivers the performance required from throttle to ice. Maximum performance tracks for ice/hard packed ovals.

SIZE	PART #
13.5" X 116" - .725" (9982R)	408489
15" X 116" - 0.725" (9995R)	408492
15" X 121" - 0.725" (9997R)	408493
15" X 121" - 0.525" (9812R)	408612



GRASS/ICE DRAG RACING TRK

Designed specifically for the intense acceleration of drag racing, where the first seconds of the race make the difference between winning and losing.

- Low-resistance 0.525" lugs require less fuel for optimal straight-line acceleration
- 13.5" width available for lightweight and maximum top speed
- Multiple lengths for a wide variety of race chassis

SIZE	PART #
13.5" X 144" - 0.525" (9084R)	408496



PEAK 2.5 MOUNTAIN TRACK

The vertical challenge requires superior traction to handle the sharp slopes and bottomless powder of high country riding. Take your mountain sled to new heights with a Camso tall lug track.

SIZES	PART #
15" X 146" - 2.5" (9182M)	408516
15" X 154" - 2.5" (9230M)	408537
16" X 154" - 2.5" (9232M)	408539
16" X 163" - 2.5" (9233M)	408540



CHALLENGER X3 MOUNTAIN TRACK

The Hacksaw track is a Rip Saw derivative featuring crescent shaped profiles with recessed tips and cutting edges for hard packed snow. Excellent handling characteristics.

SIZE	PART #
15" X 162" - 3" (9220M)	408533
15" X 156" - 3" (9309M)	408583



ICE COBRA 1.6 X-CNTRY TRACK

The "Denis Courtemanche Special Edition," in honor of long-time recreational product director who has devoted 50 years to improving snowmobile track design. Factory pre-studded with 1.6" lugs for excellent all-round performance, especially on ungroomed trails.



SIZES	PART #
15" X 120" - 1.6" (9244C)	408547
15" X 129" - 1.6" (9245C)	408548
15" X 137" - 1.6" (9246C)	408549
16" X 137" - 1.6" (9249C)	408550
15" X 144" - 1.6" (9315C)	408559
15" X 146" - 1.6" (9247C)	408566
16" X 146" - 1.6" (9250C)	408567
16" X 154" - 1.6" (9272C)	408568
15" X 154" - 1.6" (9273C)	408569
15" X 121" - 1.6" (9312C)	408585
15" X 128" - 1.6" (9313C)	408586
15" X 136" - 1.6" (9314C)	408587

BACK CNTRY X-CNTRY TRACK

Off trail means rough riding. You need a tough track with extra traction for ditch line running, boondocking, and cross-country racing in deep snow and unprepared or non-maintained conditions. Give your crossover or trail sled a big performance boost where it really counts with a Camso cross country track.

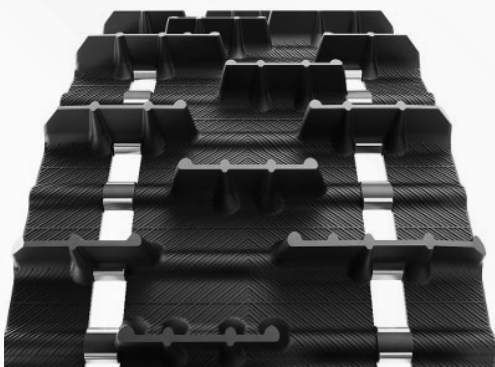

SIZES	PART #
15" X 121" - 1.75" (9140C)	408364
15" X 128" - 1.75" (9141C)	408365
15" X 136" - 1.75" (9142C)	408366
15" X 144" - 1.75" (9143C)	408367

BACK CNTRY X X-CNTRY TRACK

Recognized as a front runner for on/off-trail riding, with a 1.75" lug height and increased drive pitch. Developed and tested in competitive SnoCross racing environments, it's designed with traction and durability in mind.



SIZES	PART #
15" X 141" - 1.75" (9254C)	408551
15" X 120" - 1.75" (9287C)	408573
15" X 137" - 1.75" (9289C)	408575
15" X 153" - 1.75" (9328C)	408594



BACK CNTRY X2 X-CNTRY TRACK

The Back Country, taken to another level. Our most popular on/off-trail track, now with a lug height of 2" that lets you explore deep into the back country.

- Arched lug design with staggered SnoCross-inspired pattern for excellent soft snow traction
- Rigid lug support columns and optimized rubber compound to deliver great on/off-trail performance
- 2.86" drive pitch

SIZE	PART #
15" X 137" - 2" (9258C)	408554
15" X 146" - 2" (9417C)	408637

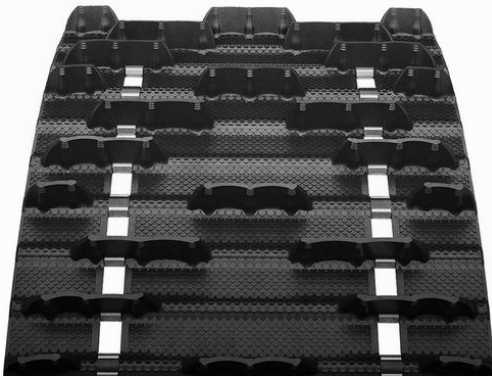

COBRA SWT UTILITY TRACK

The same durable, high-performance design as the Cobra WT, with even wider track for 24" wide applications. For utility users with wide sleds who seek quality.

- Extra tall 1.5" and 1.75" lugs provide optimal traction (1.8" lugs for Cobra WT)
- Cupped lug design ideal in soft, loose snow and for off-trail backcountry exploration
- Lightweight for greater efficiency and improved fuel economy

SIZE	PART #
24" X 156" - 1.5" (9261U)	408556

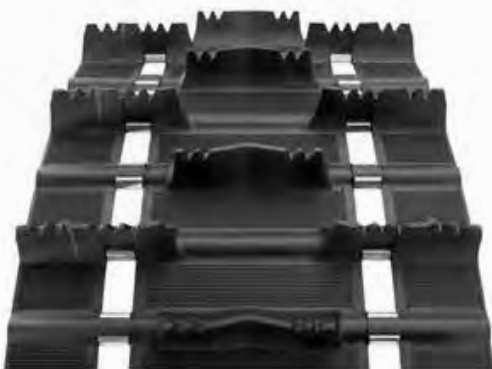

COBRA 1.6 CROSS COUNTRY TRACK

The same durable, high-performance design as the Cobra WT, with even wider track for 24" wide applications. For utility users with wide sleds who seek quality.

- Extra tall 1.5" and 1.75" lugs provide optimal traction (1.8" lugs for Cobra WT)
- Cupped lug design ideal in soft, loose snow and for off-trail backcountry exploration
- Lightweight for greater efficiency and improved fuel economy

SIZE	PART #
16" X 154" - 1.6" (9282C)	408570



CONQUER 280 MOUNTAIN TRACK

Made to advance the mountain journey. The Conquer 280 offers a lighter mountain design track providing the ultimate in flotation, traction and performance. Its next generation lug geometry reaches new levels of balance in deep snow.

- Lightweight model increases available HP thanks to less rotating mass
- Lug design requires 20% less rider input on turns and 25% less throttle to hold on side hills
- 2.8" alternating single-angled lugs push performance in all-season riding conditions

SIZE	PART #
15" X 165" - 2.8" (9340M)	408600



STORM 150 TRAIL TRACK

For aggressive adrenaline-fueled performance both on and off trail. The Camso Storm 150 is designed for modern rider-forward with a unique two-lug height design. It provides breathtaking acceleration on-trail, excellent flotation off-trail and crisp control under all circumstances.

SIZES	PART #
15" X 120" - 1.25 / 1.5" (9368H)	408608
15" X 129" - 1.25 / 1.5" (9369H)	408609
15" X 137" - 1.25 / 1.5" (9370H)	408610
15" X 146" - 1.25 / 1.5" (9371H)	408611



ICE STORM 150 TRL TRK

With its factory-installed studs, the Camso Ice Storm 150 makes precise turns on icy hills, packed snow and groomed trails, powering you through the most challenging conditions with ease. And Camso's unique two-height lug design offers deep snow flotation with handlebar-gripping acceleration.

SIZES	PART #
15" X 120" - 1.25 / 1.5" (9388H)	408619
15" X 129" - 1.25 / 1.5" (9389H)	408620
15" X 137" - 1.25 / 1.5" (9390H)	408621
15" X 146" - 1.25 / 1.5" (9391H)	408622



CONQUER 260 MOUNTAIN TRACK

Designed with a softer rubber compound for better deep-snow performance, the Camso Conquer 260's 2.6-inch lug design powers through the deepest mountain snow with ease. This lightweight track increases your machine's available horsepower, requiring less throttle input in turns and on side hills.

SIZES	PART #
15" X 154" - 2.6" (9392M)	408623
15" X 165" - 2.6" (9393M)	408624



HURRICANE 175 X-CNTRY TRACK

Inspired by mountain track lug geometry, the Hurricane 175 is the perfect balance between deep snow technology and trail-gripping adrenaline. Its 1.75-inch cupped profile design will take you deeper into the back country and out again. The efficient design is based on proven Camso mountain heritage. The Hurricane 175 provides superb off-trail performance in deep snow while maintaining on-trail agility. The 1.75-inch tall lug profile design reduces vibration, delivering more power to the snow both on and off trail.

SIZES	PART #
15" X 120" - 1.75" (9400C)	408625
15" X 129" - 1.75" (9401C)	408626
15" X 137" - 1.75" (9402C)	408627
15" X 146" - 1.75" (9403C)	408628



EPIC 280 MOUNTAIN TRACK

The Camso Epic 280 sets a new standard in deep snow mountain riding with its unique deep cup-shaped lug design. Its balanced 6-pitch lug sequence provides more track speed in deep powder and excellent floatation on the most challenging conditions. Turn your mountain adventure into an Epic ride.

SIZES	PART #
15" X 162" - 2.8" (9407M)	408633



CHALLENGER 250L TRACK

- Camso, Challenger 250L Track
- Brand new for 2021, designed for high performance in deep snow
- Optimized traction for enhanced stability and control
- Unisex design suitable for adults
- Constructed with high-strength rubber for durability
- Dimensions: 16" width and 154" length

SIZE	PART #
16" X 154" - 2.5" LUG(9430M)	408656



CHALLENGER 250LX TRACK

- The 9431M Challenger 250XL is based on the classic Challenger model with an adapted 16" width and a 3.5" pitch.
- It provides a great combination of agility and traction for deep snow riding that seems effortless thanks to a redesigned 2.5" lug that lightens the track.
- This is a full rod track
- Application – Notes: Deep Snow conditions

SIZE	PART #
16" X 165" - 2.5" LUG(9431M)	408657



CHALLENGER 300LX TRACK

The Challenger legacy continues with the 300LX, designed to conquer steep summits and deep powder. Its 15" width and aggressive 3" lugs easily navigate tight terrain and power up hills. A 16" width is also available, offering even extra float and fun in deep snow.

SIZE	PART #
16" X 154" - 3" LUG(9432M)	408658



CHALLENGER EXTREMEX TRACK

The Challenger Extreme stems from the same design as the classic Challenger but adds even higher saw-tooth lugs that, while versatile, make boondocking bottomless powder and climbing the steepest chutes seem easy.

SIZES	PART #
16" X 165" - 3.0" LUG(9448M)	408661
15" X 154" - 3.0" LUG(9470M)	408662
15" X 165" - 3.0" LUG(9471M)	408663



ICE ARROWHEAD 130 TRACK

Inspired by mountain track lug geometry, the Hurricane 175 is the perfect balance between deep snow technology and trail-gripping adrenaline. Its 1.75-inch cupped profile design will take you deeper into the back country and out again. The efficient design is based on proven Camso mountain heritage. The Hurricane 175 provides superb off-trail performance in deep snow while maintaining on-trail agility. The 1.75-inch tall lug profile design reduces vibration, delivering more power to the snow both on and off trail.

SIZES	PART #
120" X 15" (9436H)	408664
129" X 15" (9437H)	408665
137" X 15" (9438H)	408666
146" X 15" (9439H)	408667

TRACK CLIP

- Top-quality Camoplast track clips replace OEM track clips and Camoplast aftermarket tracks
- Choose from flat or guide clips using the photos and dimensions listed
- Sold in packs of 10
- Replaces Camoplast #012-0100. Could be used where Camoplast #012-0067 or #012-0100 are called for. Fit 1 in. and 1.5 in. hole tracks.

SIZES	PART #
PACK OF 10(AFT120106)	408641
PACK OF 10(AFT120107)	408642
PACK OF 10(AFT120113)	408647
PACK OF 10(AFT120116)	408649
PACK OF 10(AFT120117)	408650







TABLE OF CONTENTS

BRIDGESTONE	178-179
CARLISLE	180-181
COUNTERACT	182-183
KENDA	184-189
TIRE TECH	190
PIRELLI	191

OFFROAD MOTORCYCLE TUBES

MOTOCROSS OFFROAD TUBES

- Original Equipment sizes
- TR4 and PV-78 valve types

TUBE TYPE RUBBER BASE VALVES

TR4



PV-78



SIZES	TUBE TYPE	ADDITIONAL FITMENT DETAIL	VALVE TYPE	PART #
130/90-16 / 130/90B16	TR-4		TR-4	835489
140/90 / 150/80-16	TR-4		TR-4	835500
140/90 / 150/80-16	PV-78		PV-78	835482
180/70-15 / 180/65B16	PV-78		PV-78	835507
140/90-15	TR-4		TR-4	835490
140/90-15	PV-78	(also fits 150~160)	PV-78	835481
140B / 160/70-17	TR-4		TR-4	835501
180/60B17	TR-4		TR-4	835502
120/90 / 4.60-18	TR-4		TR-4	835505
80/90-21	TR-4		TR-4	835504
110/90A-R17	Radial, TR-4	Radial (120/70R17)	TR-4	835508
150 / 160/70-17	Radial, TR-4	Radial (160/60R17)	TR-4	835491
325A / 100/90A-19	TR-4	Triumph Scrambler	TR-4	835496
120 / 90D-R17	TR-4	Triumph Scrambler	TR-4	835488
2.75B / 3.50-21	TR-4	Honda CRF230L	TR-4	835503
100/100B-18	TR-4	Honda CRF230L	TR-4	835484
110/70R17	Radial, TR-4	Yamaha WR250X	TR-4	835486
80/90-21	TR-4	Kawasaki Vulcan VN800	TR-4	835499
110/90-19	TR-4	Suzuki Intruder VS 1400	TR-4	835487
170/80-15	PV-78	Suzuki Intruder VS 1400	PV-78	835483
110/100-18	TR-4	Yamaha TW200	TR-4	835485
180/80-14	TR-4	Yamaha TW200	TR-4	835492
2.50-18	TR-4	Yamaha TW200	TR-4	835493

TR4



PV-78



HEAVY DUTY & ULTRA HEAVY DUTY

MOTOCROSS OFFROAD TUBES

- Heavy duty, puncture resistant 3mm natural rubber
- Ultra-heavy duty is an industry leader—4mm of natural rubber
- Standard tube available in all mini-sizes

SIZES	VALVE TYPE	PART #
MINI BIKE MOTOCROSS TUBES		
250/70/100-10	TR-4	835494
60/100-12	TR-4	835497
275-80/100-12	TR-4	835495
60/100-14	TR-4	835498
90/100-14	TR-4	835470
325/350-16	TR-4	835467
70/100-17	TR-4	835468
70/100-19	TR-4	835469
MOTOCROSS HEAVY DUTY		
100/100-18	TR-4	835471
110/100-18	TR-4	835473
100/110/80-19	TR-4	835472
110/90-19	TR-4	835474
80/100-21	TR-4	835475
MOTOCROSS ULTRA HEAVY DUTY		
100/100-18	TR-4	835476
110/100-18	TR-4	835478
100/110-80-19	TR-4	835477
110/90-19	TR-4	835479
80/100-21	TR-4	835480



CARLISLE TUBES

- Heavy Duty Material Built to Last Longer: This Inner Tube is made from High Quality Butyl Rubber. These inner tubes are highly durable and ideal for home, professional and commercial / industrial use in tire application
- Compatible with: It works with lawn mowers / tractors, hand trucks, wheelbarrows, garden / utility / flat carts, yard trailers, dollies, trolleys, wagons, generators, snow blowers, pressure washers, air compressors, wood chippers and more
- Tube / Valve Type: ATV, Lawn & Garden, Go Kart Replacement Tire Applications with a Valve Type: TR6 for Rim Size: 14 Inch with Lock Nuts



LAWN & GARDEN

SIZES	VALVE	MFG #	PART #
AT16x8.00R7	TR6	320035	Y-0702
280 X 2.50-4	TR87	320050	Y-0401
410 X 3.50-4	TR87	320100	Y-0402
410 X 3.50-4	TR87	320020	Y-0403
410 X 3.50-4	TR13	320040	Y-0411
9 X 3.50-4	TR87	320030	Y-0430
9 X 3.50-4	TR87	320031	Y-0431
340 X 3.00-5	TR87	320150	Y-0501
410 X 3.50-5	TR87	320200	Y-0502
11 X 4.00-5	TR87	320080	Y-0504
410/350-5	TR13	320070	Y-0505
410 X 3.50-5	TR87	320060	Y-0506
10 X 4.50-5	TR87	323980	Y-0509
11 X 6.00-5	TR87	323520	Y-0511
410 X 3.50-6	TR87	320250	Y-0601
15 X 6.00-6	TR87	320290	Y-0602
13 X 5.00-6	TR87	320260	Y-0604
15 X 600 - 6	TR13	323800	Y-0605
13 X 6.50-6	TR13	320170	Y-0607
410 X 3.50-6	TR13	320160	Y-0609
13 X 5.00-6	TR13	323790	Y-0611
530 X 4.50-6	TR87	320270	Y-0670
350 X 4.00-8	TR87	320360	Y-0801
480 X 4.00-8	TR13	320400	Y-0803
570 X 5.00-8	TR13	320450	Y-0804
16 X 6.50/7.50-8	TR13	320420	Y-0805
480 X 4.00-8	TR87	320130	Y-0806
22X11.00-8	TR6	320440	Y-0809
18 X 6.50/8.50/9.50-8	TR13	320410	Y-0811
350 X 4.00-8	TR13	320120	Y-0821
690 X 6.00-9	TR13	321500	Y-0902
20X8.00/10.00-10	TR13	320770	Y-1070
530 X 4.50-12	TR13	320901	Y-1202
23X8.50/9.50/10.50-12	TR13	321370	Y-1207
22/23 X 8	TR11/12	321371	Y-1210
24/26 X 12	TR12	321051	Y-1212
26 X 12-12	TR13	321050	Y-1250
26X8/9R14	TR6	324500	Y-1251

CARLSTAR



TIRES & TRACKS

TUBES

CHEMICALS

TOOLS

BATTERIES

FUEL & INTAKE

AIR & OIL FILTERS

FAST SAME DAY SHIPPING

COUNTERACT TUBES

COUNTERACT READY BALANCE TUBES

- High quality 1.5mm thick butyl tube pre-loaded with Counteract Balancing Beads
- Balanced for the life of the tire
- Extend tire life, even tread wear, increases horsepower due to decreased rolling resistance
- Provides the smoothest and most efficient ride possible
- No need for unsightly wheel weights or a tire balancer
- Cost effective
- Will not void tire warranties

SIZES	VALVE	MFG #	PART #
5.00/5.10-16	TR6	MKT-01	746114
5.00/5.10-16	(90 DEGREE) TR87	MKT-02	746115
6.00/6.50-17	TR6	MKT-03	746116
4.00/4.50-17	TR6	MKT-04	746117
4.00/4.60-18	TR6	MKT-05	746118
5.00/5.10-18	TR6	MKT-06	746119
2.75/3.00-21	TR6	MKT-08	746120
2.75/3.00-23	TR6	MKT-09	746121
5.00/5.10-18	(RIMLOCK) TR6	MKT-10	746122
2.50/3.00-17	TR6	MKT-11	746123
3.00/3.50-12	TR6	MKT-13	746124
2.50/2.75-12	TR6	MKT-14	746125
3.00/3.50-10	TR87	MKT-15	746126
2.50/2.75-10	TR87	MKT-16	746127
5.00/5.10-16	(SIDE VALVE) TR6	MKT-17	746128



STANDARD TUBES

VALVE STEM TYPES

STANDARD TUBES THICKNESS: 1.2-1.3MM

- TR4, TR6 Straight Metal Stem
- TR13 Narrow Rubber Stem
- TR15 Standard Rubber Stem
- TR87C, JS87 Bent Metal Stem 90 Degree
- JS2, PRV78 Bent Metal Stem 90 Degree



SIZES	VALVE TYPE	PART #
250/275-10	TR-4	250104
250/275-10	TR-87C	250105
250/275-10	TR-244	250106
300/325-10	TR-13	250107
300/325-10	TR-87C	250108
350/400-10	TR-6 OFF	250109
350/400-10	TR-13	250110
350/400-10	TR-87C OFF	250111
400/450-10	TR-13	250113
400/450-10	TR-87C	250114
120/130/70-12	TR-6	250115
120/130/70-12	TR-87	250116
275/300-12	TR-4	250117
325/350-12	TR-6	250118
400/450-12	TR-6	250119
200/225-14	TR-4	250120
250/275-14	TR-4	250121
275/300-14	TR-4	250122
325/350-14	TR-4	250123
225/250-15	TR-4	250124
275/300-15	TR-4	250125
300/325-15	TR-4	250126

SIZES	VALVE TYPE	PART #
200/225-16	TR-4	250127
225/250-16	TR-4	250128
250/275-16	TR-4	250129
275/300-16	TR-4	250130
300/325-16	TR-4	250131
325/350-16	TR-4	250132
200/225-17	TR-4	250133
250/275-17	TR-4	250134
275/300-17	TR-4	250135
300/325-17	TR-4	250136
325/350-17	TR-4	250137
375/425-17	TR-6	250138
225/250-18	TR-4	250139
250/275-18	TR-4	250140
300/325-18	TR-4	250142
325/350-18	TR-4	250143
350/400-18	TR-6	250144
375/425-18	TR-6	250145
500/530-18	TR-6	250147
200/225-19	TR-4	250148
225/250-19	TR-4	250149
250/275-19	TR-4	250150

SIZES	VALVE TYPE	PART #
275/300-19	TR-4	250151
300/325-19	TR-4	250152
325/350-19	TR-4	250153
325/350-19	TR-13	250154
400/450-19	TR-6	250155
300/325-21	TR-4	250156
325/350-21	TR-4	250157
275/300-23	TR-4	250158
300/325-23	TR-4	250159
275/300-18	TR-4	250141
225/250-14	TR-4	250315
225/250-17	TR-4	250316
275/300-21	TR-4	250317
300/325-12	TR-4	250318
350/400-19	TR-6	250319
360/410-14	TR-6	250320
400/450-18	TR-6	250321
450/510-18	TR-6	250322
450/510-19	TR-6	250323
430/510-18	TR-6	250324
90/90-15	TR-6	250459

Kenda butyl rubber tubes are offered in a variety of sizes and applications.

TUFF TUBES



- 2.5mm heavy duty butyl rubber “TUFF Tubes” designed to resist punctures and pinch flats.
- Fits all popular MX sizes!
- TUFF Tubes are two times thicker than OEM tubes and are designed specifically for motocross and off-road use.

SIZES	PLY	PART #
2.50/275 - 10 - 10	TR4	KD8801
80/100 - 12	TR4	KD8802
60/100 - 14	TR4	KD8803
90/100 - 14	TR6	KD8804
90/100 - 16	TR6	KD8805
70/100 - 17	TR4	KD8806
110/120/100 - 18	TR6	KD8807
70/100 - 19	TR6	KD8808
100/90 - 19	TR6	KD8809
110/120/90 - 19	TR6	KD8810
80/100 - 21	TR4	KD8811
250 - 12	TR4	KD8812
100/100 -18	TR6	KD8813



FAST SAME DAY SHIPPING

SUPER TUFF TUBES



- 3.6-3.7mm heavy duty butyl rubber designed to resist punctures and pinch flats.
- Fits all popular MX sizes!
- SUPER TUFF Tubes are THREE times thicker than OEM tubes and are designed specifically for motocross and off-road use.

SIZES	VALVE TYPE	PART #
110/100-18	TR-6	250481
120/100-18	TR-6	250482
110/90-19	TR-6	250483
80/100-21	TR-6	250484

KENDA INNER TUBE



- The Kenda 11083030 Inner Tube is a durable, standard-duty rubber tube designed for motorcycles using 570/500-8 tires. It features a TR-13 straight valve stem.

TUBE SIZE	VALVE TYPE	PART #
410/350-4	TR-87	250449
410/350-5	TR-87	250450
410/350-6	TR-87	250451
480/400-8	TR13	250454
300/325-10	TR-6	250457
570/500-8	TR-13	250455
400-9	TR-13	250456

RIM STRIPS



KENDA STANDARD RIM STRIP

Effectively protects tube against mechanical damage such as punctures and tears caused by spoke heads and metal burrs around the spoke hole.

- Features:
 High-quality rubber construction
 Will fit with 14" to 21" diameter wheels
 1-1/4" width
 Center valve stem
 Sold each

SIZES	PART #
28mm wide, fits 14-15" rims	250160
32mm wide, fits 18-19" rims	250163
22mm wide, fits 20-21" rims	250164

MOTORCYCLE STREET TIRE SIZE CONVERSION CHART

METRIC		ALPHA	INCH
FRONT TIRES			
80/90	MH90	2.50/2.75	TR-4
90/90	MJ90	2.75/3.00	TR-4
100/90	MM90	3.25/3.50	TR-4
110/90	MN90	3.75/4.00	TR-4
120/80	----	4.25/4.50	TR-4
120/90	MR90	4.25/4.50	TR-4
130/90	MT90	5.00/5.10	TR-4
REAR TIRES			
110/90	MP85	4.50/4.75	TR-4
120/90	MR90	4.50/4.75	TR-4
130/80	----	5.00/5.10	TR-6
130/90	MT90	5.00/5.10	TR-4
140/80	----	5.50/6.00	TR-4
140/90	MU90	5.50/6.00	TR-4
150/80	MV85	6.00/6.25	TR-4
150/90	MV85	6.00/6.25	TR-4

MOTORCYCLE KNOBBY TIRE SIZE CONVERSION CHART

METRIC		ALPHA	INCH
FRONT TIRES			
60/100 90/80	2.50/2.75	2.50/2.75	TR-4
70/100 90/90	2.75/3.00	2.75/3.00	TR-4
80/100 100/80	3.00/3.25	3.25/3.50	TR-4
REAR TIRES			
80/100 80/90	2.50/3.60	4.50/4.75	TR-4
90/100 110/90	3.60/4.10	4.50/4.75	TR-4
100/100 120/80	4.00/4.10	5.00/5.10	TR-6
110/100 130/80	4.00/4.50	5.00/5.10	TR-4
120/100 140/80	5.00/5.15	5.50/6.00	TR-4

KENDA TUBES

- TR4, TR6 TR13 TR15 TR87C, JS87 JS2, PRV78 PART # Straight Metal Stem
Narrow Rubber Stem Standard Rubber Stem Bent Metal Stem 90 Degree
Bent Metal Stem 90 Degree



TUBE SIZE	MFG #	VALVE TYPE	PART #
280 X 2.50-4	320010	TR87P	Y-0406
145 X 70-6	7143	TR13	Y-0600
145 X 70-6	11061706	TR87	Y-0615
400 X 6	904	TR13	Y-0606
18 X 8.50/9.50 X 8	11086820	TR6	Y-0807
22 X 11.00-8	11088430	TR13	Y-0812
22X11.00-9	11098420	TR6	Y-0907
25X12.00-9	321520	TR6	Y-0904
25X12.00-9	11099230	TR13	Y-0905
21X7.00-10	11108020	TR6	Y-1018
22X8.00-10	11108320	TR6	Y-1017
22X11.00-10	11108420	TR6	Y-1016
23.5X8.00-11	11119020	TR6	Y-1101
24X9.00-11	11119120	TR6	Y-1102
25X8.00-12	11084520	TR6	Y-1204
25X10.00-12	11109520	TR6	Y-1205
25/26 X 12 X 12	11129220	TR6	Y-1206



DESCRIPTION	HOLE SIZE	LENGTH	MFG #	PART #
RUBBER STEM SNAP IN STRAIGHT	1/2"	1"	TR412	690412
RUBBER STEM SNAP IN STRAIGHT	1/2"	1-1/4"	TR412	690413

KENDA



FAST SAME DAY SHIPPING



Tire Tech is our new line of on and/or offroad tire products manufactured from the highest quality materials available. The most popular sizes are available in 4 thicknesses.

- Standard Tubes = 1.3mm
- Heavy Duty Tubes = 2mm
- Ultra Heavy Duty Tubes = 3mm
- Super Heavy Duty Tubes = 4mm

TUBE SIZE	VALVE TYPE	VALVE TYPE	MFG #	PART #
STD 1.3mm TUBES				
60/100-14	1.3 MM	TR4	2.25/2.50-14	129872
80/100-21,90/90-21	1.3 MM	TR4	2.75/3.00-21	129888
100/90-19, 110/90-19	1.3 MM	TR4	4.00-19	129881
110/90-18, 120/90-18	1.3 MM	TR4	4.50-18	129876
80/100-12	1.3 MM	TR4	3.00/3.25-12	129870
70/100-19	1.3 MM	TR4	2.50/2.75-19	129882
120/100-18, 130/90-18, 140/80-18	1.3 MM	TR4	4.50/5.00-18	129877
110/120/90-19	1.3 MM	TR4	4.50-19	129883
120/140/90-19	1.3 MM	TR4	4.50/5.00-19	129884
60/100-10	1.3 MM	TR4	2.50/2.75-10	129867
100/110/90-18, 110/120/80-18	1.3 MM	TR4	3.50/4.00-18	129878
120/90-18	1.3 MM	TR4	4.25/4.50-18	129879
HEAVY DUTY 2 mm TUBES				
110/90-19	2 MM	TR4	3.50/4.00-19	129885
80/100-21, 90/90-21	2 MM	TR4	2.75/3.00-21	129889
ULTRA HEAVY DUTY 3 mm TUBES				
80/100-21,90/90-21	3 MM	TR4	2.75/3.00-21	129890
100/90-19, 110/90-19	3 MM	TR4	4.00-19	129886
110/90-18, 120/90-18	3 MM	TR4	4.50-18	129880
70/100-19	3 MM	TR4	2.50/2.75-19	129887
60/100-10	3 MM	TR4	2.50/2.75-10	129868
SUPER HEAVY DUTY 4 mm TUBES				
90/100-21	4 MM	TR4	3.00-21	129891



PIRELLI HEAVY DUTY INNER TUBE

Item type: Pirelli Heavy Duty Inner Tube.

Size: 10, 12, 14, 16, 17, 18, 19, 21 inches, which refers to the rim size it is designed to fit.

Valve type: TR-4 center metal valve stem.

Valve location: Center of the tube, as opposed to offset.

Construction: Made from a thick, natural rubber blend for durability and puncture resistance.



TUBE SIZE	VALVE TYPE	PART #
17"	TR-4	747294
18"	TR-4	747295
18"	TR-4	747296
19"	TR-4	747297
21"	TR-4	747298
21"	TR-4	747299
10"	TR-4	747300
12"	TR-4	747301
14"	TR-4	747302
14"	TR-4	747303
16"	TR-4	747304
19"	TR-4	747305
17"	TR-4	747306





TABLE OF CONTENTS

BIKE BRITE	194	MOTUL	260-267
BIO-KLEEN	195-196	MYSTIK LUBRICANTS	268
CALIBER INC.	197	NOVUS PLASTIC	269
ENGINE ICE	198	ORIGINAL BIKE SPIRITS	270
EVANS COOLANT	199	PERMATEX	271-272
GOLD EAGLE CHEMICALS	200	PIG SPIT	273
INOVEX INDUSTRIES RIDE ON	201	PJ1	274-277
JB WELD	202	PLEXUS	278
K&N	203	S100	279-280
K100	204	STA-BIL	281-283
KLOTZ	205-219	STARBRITE	284-288
LEAR CHEMICALS	220	THREEBOND	289-292
LIQUID PERFORMANCE	221	TWIN AIR	293-294
LIQUI MOLY	222-233	UNI FILTER	295
LUBRIMATIC	234		
MAXIMA	235-244		
MOTION PRO	245		
MOTOREX	246-259		



RETAIL RACK

This Bike Brite Retail Display (model MC44DS, part number 9903-0387) is a high-quality point-of-purchase accessory designed to showcase products effectively, whether in motorcycle shops, parts retailers, or trade shows. Ideal for drawing attention to featured items, it blends both aesthetics and durability—perfect for professionals wanting their merchandise to stand out.

DESC	QTY/CS	PART #
Bike Brite Retail Display	N/A	962028



BLUE BUSTER POWDER

Specially formulated to remove exhaust pipe bluing, Blue Buster restores metals to their original shine. Also ideal for chrome and metallic trims, keeping them brilliant and protected.

DESCRIPTION	QTY/CS	PART #
1 oz	12	962001



MOTO GLAZE

Protects against UV rays, heat, salt, and grime with carnauba wax. Easy to apply, removes oxidation, and leaves no residue. Made in the U.S.A.

DESCRIPTION	QTY/CS	PART #
8 oz	12	962019



MOTO MASK ON

6.5 Oz Moto Mask On by Bike Brite®. This top-grade product is expertly made in compliance with stringent industry standards to offer a fusion of a well-balanced design and high level of craftsmanship.

DESCRIPTION	QTY/CS	PART #
6.5 oz	12	962022



MICRO FIBER CLOTH

Microfiber towel absorbs 8× its weight, cleans without chemicals, and leaves a streak-free, scratch-free finish. Washable and reusable. Made in China, packaged in the U.S.A.

DESCRIPTION	QTY/CS	PART #
Microfiber cloth	6	962017



MAN MADE DRYING CLOTH

Bike Dry™ Man Made Drying Cloth by Bike Brite® is a 4 sq. ft. professional-grade, ultra-absorbent chamois. Compact for saddlebag storage, it's perfect for drying windshields, seats, shields, goggles, and even for personal use.

DESCRIPTION	QTY/CS	PART #
Drying cloth	6	962020



MOTO MASK OFF

Removes Moto-Mask On from all surfaces. Leaves no residue. Can be buffed to a high shine. Also can be used as a quick detailer. Safe and Non-toxic.

DESCRIPTION	QTY/CS	PART #
16 oz	12	962023



MOTO MASK WINDSCREENS

Specially formulated for motorcycle windshields. Makes beads of water disappear on windshields or faceshields, improves your vision in rain, drizzle or misting conditions. Safe on polycarbonates or acrylics.

DESCRIPTION	QTY/CS	PART #
4 oz	12	962025



MOTO MASK ON/OFF DISPLAY

Contains 6 6.5 cans of Moto Mask On and 6 16 oz. Spray Bottles of Moto Mask Off in a handsome counter display box.

DESCRIPTION	QTY/CS	PART #
On/off pop display	1	962024



BIKE MAGIK DEGREASER

Bike Magik Qwik Kleen Degreaser quickly removes boot marks, grease, carbon, and grime. Safe for bikes, ATVs, engines, chrome, and painted surfaces.

DESCRIPTION	QTY/CS	PART #
4 oz	12	700101



METAL POLISH

Snowmobile metal and tunnel polish restores shine, removes dullness, and seals for lasting protection. A 2 oz. bottle covers 75+ sq. ft.

DESCRIPTION	QTY/CS	PART #
2 oz	12	700105



SLEDBRITE KRYSTAL VIEW

Biodegradable, non-aerosol cleaner for goggles, glass, and plastic. Anti-fog formula also works great on helmets and windshields. Ozone safe.

DESCRIPTION	QTY/CS	PART #
4 oz	12	700106



LEATHER, VINYL, FABRIC

Biodegradable, ozone-safe cleaner for snowmobile vinyl, fabric, and leather. pH-balanced to safely remove embedded dirt without harming delicate materials.

DESCRIPTION	QTY/CS	PART #
4 oz	12	700107



RENEW

Fast-drying liquid metal polish restores a brilliant shine to all metal surfaces and can also rejuvenate fiberglass. A 4 oz. bottle covers 150+ sq. ft.

DESCRIPTION	QTY/CS	PART #
4 oz	12	700113



FIBERGLASS CLEANER

Biodegradable, non-aerosol hull cleaner for marine and RV use. Removes scum, algae, scale, yellowing, and light oxidation from fiberglass, metals, and aluminum surfaces.

DESCRIPTION	QTY/CS	PART #
16 oz	12	700117
32 oz	12	700127



AMAZING ARMOR

Biodegradable, non-aerosol vinyl conditioner that renews and protects vinyl, leather, rubber, and more. Guards against UV rays, ozone, and cracking, and seals rubber RV roofs.

DESCRIPTION	QTY/CS	PART #
16 oz	12	700115
32 oz	12	700123



AMAZING CLEANER

Biodegradable, non-aerosol cleaner for vinyl, leather, fabric, and more. Removes dirt, stains, mold, mildew, and bug debris, and cleans chalk residue from rubber RV roofs. Ideal for boats, RVs, and trailers.

DESCRIPTION	QTY/CS	PART #
32 oz	12	700124



ALUMA KLEEN

Biodegradable, non-aerosol, ozone-safe aluminum cleaner that removes oxidation, stains, and discoloration. Ideal for boats, pontoons, diamond plate, rims, and running boards.

DESCRIPTION	QTY/CS	PART #
32 oz	12	700122



QWIK SHINE

Spray on polish motorcycle detailing spray. Waterless motorcycle bike wash also adds UV protection. Biodegradable, Non Aerosol

DESCRIPTION	QTY/CS	PART #
16 oz	12	700139
4 oz	12	700142



BILGE CLEANER

Biodegradable, non-aerosol bilge cleaner dissolves sludge, grease, and grime. Neutral pH, concentrated formula makes up to 8 gallons and includes a sanitizer to keep bilges and livewells fresh.

DESCRIPTION	QTY/CS	PART #
32 oz	12	700125



REMOVE ALL

Powerful engine degreaser that quickly removes tough buildup and road tar. Rinses away easily for fast, effective cleaning of engines and parts.

DESCRIPTION	QTY/CS	PART #
32 oz	12	700131



OXIDATION REMOVER

Biodegradable, non-aerosol fiberglass stain remover that eliminates yellowing, oxidation, chalkiness, and spider droppings from boat hulls and RV exteriors.

DESCRIPTION	QTY/CS	PART #
32 oz	12	700129



SALT KLEEN

Bio-Kleen Salt Klean is a biodegradable, non-aerosol salt neutralizer that removes salt buildup from any surface while helping protect against rust and corrosion.

DESCRIPTION	QTY/CS	PART #
32 oz	12	700134



RESTORE & SHINE XTRA CUT

Restore & Shine Xtra Cut polishes and restores faded fiberglass, removes scratches and oxidation, and provides UVA/UVB protection up to 250°F. Silicone-free, VOC compliant.

DESCRIPTION	QTY/CS	PART #
32 oz	12	700133



SUPER SUDS WASH

Super-concentrated, biodegradable wash for boats, RVs, and vehicles—32 oz. makes up to 32 gallons. Removes scum, dirt, insects, and water spots while leaving added shine and protection. Phosphate-free and non-aerosol.

DESCRIPTION	QTY/CS	PART #
32 oz	12	700135



WHEEL GEL

Biodegradable, non-aerosol rim cleaner that safely cleans all rim types, tires, and wheels. Removes brake dust and rail dust from vehicles and trailers.

DESCRIPTION	QTY/CS	PART #
32 oz	12	700136



SLYDZ-ON

Spray-On Bunk Lubricant

Launching your boat or watercraft has never been easier:

- Easily load and unload after application
- Less strain on bow-eyes, pulleys, cranks, and users
- Reduces chances for power-loading
- Fast and simple application for both horizontal and vertical bunks.
- Also works on workstations, boat lifts and watercraft dollies.

DESC	QTY/CS	PART #
16 FL OZ	12	PD23200



HI-PERFORMANCE MOTORCYCLE COOLANT + ANTIFREEZE

Perfect for use in almost every vehicle over all types of terrain. Engine Ice is easy to use in the convenient 1/2 gallon bottle. Pre-mixed to save you time, choose Engine Ice when you make your next coolant change.

DESCRIPTION	QTY/CS	PART #
64 FL OZ (1/2 G) 1.8L	4	998245



HI-PERFORMANCE SXS/ATV COOLANT + ANTIFREEZE

Engine Ice Hi-Performance SXS/ATV Coolant + Antifreeze is specially formulated for SXS and UTV machines to enhance performance through superior heat dispersion and temperature control.

DESCRIPTION	QTY/CS	PART #
64 FL OZ (1/2 G) 1.8L	4	998249



HI-PERFORMANCE SNOWMOBILE & WINTER COOLANT + ANTIFREEZE

Engine Ice Snowmobile & Winter Coolant offers premium freeze protection and heat dispersion. Pre-mixed and ready to use in a 1/2-gallon bottle.

DESCRIPTION	QTY/CS	PART #
64 FL OZ (1/2 G) 1.8L	4	998251



ICE WATER

Engine Ice - Ice Water improves the ability of water to wet transfer surfaces by 50%, providing a significant reduction in surface tension, moving heat away from the engine faster than competitive products.

DESCRIPTION	QTY/CS	PART #
12 FL OZ (355 mL)	5	998252



COOLANT SYSTEM FLUSH AND CLEAN

Engine Ice Coolant System Flush and Clean is an easy-to-use product designed to help maintain your cooling system and its components. Maintenance is less expensive than repairs.

DESCRIPTION	QTY/CS	PART #
64 FL OZ (1/2 G) 1.8L	4	998253



ENGINE ICE PURE PERFORMANCE RACING COOLANT

Engine Ice Pure Performance Coolant reduces surface tension and rapidly dissipates heat for maximum engine performance.

DESCRIPTION	QTY/CS	PART #
64 FL OZ (1/2 G) 1.8L	4	998255



EVANS COOLANT NPG WATERLESS COOLANT

NPG can be used in high performance street vehicles with high flow cooling systems, as well as for food service equipment where ethylene glycol products are contraindicated.

DESCRIPTION	QTY/CS	PART #
64 FL OZ (1/2 G) 1.8L	4	994000



EVANS PREP FLUID

Evans Prep Fluid is a waterless cooling system flush engineered specifically to purge the cooling system of water-based antifreeze after draining and before installing new waterless coolant. Prep Fluid should be used when block drains are unavailable or cannot be removed.

DESCRIPTION	QTY/CS	PART #
(1 GAL) 3.77L	4	994002



EVANS HIGH PERFORMANCE WATERLESS COOLANT

Evans High Performance Waterless Coolant is made for gasoline and light-duty diesel engines. It eliminates issues caused by water in traditional coolants, improving reliability and extending engine life.

DESCRIPTION	QTY/CS	PART #
(1 GAL) 3.77L	4	994003



EVANS POWERSPORTS WATERLESS COOLANT

Evans Powersports is a proprietary blend of glycols and inhibitors formulated to be used without water. Evans waterless coolants are compatible with silicone hoses.

DESCRIPTION	QTY/CS	PART #
0.5 U.S. GAL (1.89L)	4	994004



EVANS POWERSPORTS WATERLESS COOLANT

Evans Powersports is a proprietary blend of glycols and inhibitors formulated to be used without water. Evans waterless coolants are compatible with silicone hoses.

DESCRIPTION	QTY/CS	PART #
1 GAL (3.78L)	4	994010



303® AUTOMOTIVE PROTECTANT

Leaves a dry, natural finish with no greasy feel while repelling lint, dust, and stains. Offers superior UV protection for rubber, vinyl, and plastic, helping surfaces stay brighter, resist cracking, and last longer.

DESCRIPTION	QTY/CS	PART #
UV Protectant 16oz	6	452006



STA-BIL® IN-SEASON PROTECTION FUEL TREATMENT

Cleans and protects the entire fuel system while boosting engine power and efficiency. Formulated with PEA cleaners for effective in-season, everyday treatment.

DESCRIPTION	QTY/CS	PART #
10 oz Ethanol Treatment	6	452002



STA-BIL® CARB & CHOKER CLEANER

Carb & Choke Cleaner removes deposits for smoother starts, idle, and acceleration. Restores performance; safe for sensors and catalytic converters.

DESCRIPTION	QTY/CS	PART #
12.5 oz	6	452005



104+® OCTANE BOOST

Boost engine power and improve gas mileage with this 16 oz. fuel treatment. It cleans injectors, reduces knocks and hesitation, and is safe for catalytic converters and O2 sensors. Treats up to 18 gallons.

DESCRIPTION	QTY/CS	PART #
Octane Boost 16 oz.	6	STA10406



STA-BIL® FUEL STABILIZER

America's #1 Fuel Stabilizer keeps fuel fresh for up to 24 months. Prevents gum and varnish buildup for easy starts. Works with ethanol and non-ethanol gas in all gasoline engines—cars, bikes, boats, generators, and more. No need to drain fuel before storage.

DESCRIPTION	QTY/CS	PART #
4 oz	6	STA1104
8 oz	6	STA1118
10 oz	6	452004
32 oz	6	STA1132



STA-BIL® FOGGING OIL

STA-BIL Fogging Oil prevents corrosion and cylinder damage by coating and lubricating engine parts. Safe for all 2- & 4-cycle gasoline engines.

DESCRIPTION	QTY/CS	PART #
12 oz Fogging Oil	6	STA1210



STA-BIL 360® MARINE™

America's top marine fuel treatment combats ethanol effects, removes water, cleans fuel systems, and keeps fuel fresh up to 12 months. Safe for all boats and jet skis.

DESCRIPTION	QTY/CS	PART #
Ethanol Treatment 8oz	6	STA22239
Ethanol Treatment 32oz	6	STA22240



ANTI-FREEZE & WATER REMOVER

#1 gas-line antifreeze and water remover. Prevents freeze-ups, removes water, and protects against rust. Safe for all 4-cycle engines.

DESCRIPTION	QTY/CS	PART #
Gas Line 12oz	6	STA5120
Iso-Heet 12oz	6	STA5360



RIDE-ON MOTORCYCLE TIRE BALANCER & SEALANT 8OZ

- Ride-On is specially formulated to hydro dynamically balance high-speed tires; dampen road noise and vibrations that cause a rough ride
- Eliminates need for those old ugly wheel weights
- Ride-On TPS (Tire Protection System) is a tire balancer and sealant compound that evenly coats the inner surface of your tires
- This coating balances your tires and makes them into self-sealing tires while you ride

After installing the Ride-On Tire Balancer & Sealant into your tires you may notice a slight vibration until the sealant has warmed up and distributed evenly in your tires. This process usually takes 2-5 miles. Please DO NOT attempt to rebalance tire's after the installation of Ride-On Tire Balance & Sealant. Ride-On will act as a balancer and will result in erroneous readings from a dynamic spin balancer.

DESC	MFG#	PART #
Tire Sealant 8oz	41208	650274



RIDE-ON TIRE SEALANT FOR ATVS AND UTVS

- Ride-On TPS (Tire Protection System) is a tire balancer and sealant compound that evenly coats the inner surface of tires
- This coating balances tires and makes them into self-sealing tires while you ride
- Eliminates need for those old ugly wheel weights
- Specially formulated to hydro dynamically balance high-speed tires, dampen road noise and vibrations that cause a rough ride
- If your tire is punctured, the centrifugal force of the rotating tire and the internal air pressure force Ride-On into the hole, sealing it instantly (Up to 1/4in. in tubeless tires and 1/8in. in tube tires)

DESC	MFG#	PART #
Tire Sealant 32oz	71232	650275



MINUTEWELD SYRINGE

MinuteWeld™ is a fast-setting, high-strength two-part epoxy that bonds in just one minute. Works on ceramic, tile, glass, stone, most plastics, wood, and metal, even in varying temperatures.

DESCRIPTION	MFG#	PART #
Minuteweld 25 ml	50101	446014



WOODWELD SYRINGE

WoodWeld™ Syringe is a fast-setting, two-part adhesive for wood bonding and repairs. Cures to a light tan color and can be shaped, sanded, drilled, and more. Creates a permanent bond stronger than wood itself.

DESCRIPTION	MFG#	PART #
Woodweld 25 ml	50151	446018



PRO SIZE BLISTER TWIN TUBE

J-B Weld™ is The Original Cold Weld two-part epoxy system that provides strong, lasting repairs to metal and multiple surfaces. Mixed at a ratio of 1:1, it forms a permanent bond and can be shaped, tapped, filed, sanded and drilled after curing.

DESCRIPTION	MFG#	PART #
Twin tube 5 oz	8281	446028



KWIK WOOD EPOXY

KwikWood™ is a hand-mixable epoxy putty, formulated to repair and rebuild wood. After mixing, it cures to the same density as wood and becomes an integral part of the repair.

DESCRIPTION	MFG#	PART #
Kwikwood 10 oz	8257	JB8257



KWIK STICK PRO SIZE

KwikWeld™ Professional is a professional-sized version of our fast setting KwikWeld™ two-part epoxy cold weld system. It provides strong, lasting repairs to metal and multiple other surface types.

DESCRIPTION	MFG#	PART #
Professional Size 10 oz	8271	JB8271



MARINEWELD TWIN TUBE

MarineWeld™ is a specially formulated two-part epoxy cold weld system that provides for strong, lasting repairs for bonding different or similar surfaces, such as aluminum, metal, composites, fiberglass and others.

DESCRIPTION	MFG#	PART #
Twin tube 2 oz	8272	JB8272



WATERWELD EPOXY PUTTY

J-B Weld WaterWeld will plug or seal leaks and patch holes and cracks in almost anything. Ideal for repairing plumbing, fuel tanks, tub and shower, drains, pool and spa, boats and potable water tanks; setup occurs even under water.

DESCRIPTION	MFG#	PART #
Epoxy Putty 2 oz	8277	JB8277



GASKET MAKER AND SEALANT

Is an RTV Silicone gasketing material designed for use in mechanical assemblies where higher torque or closely spaced bolt profiles can cause sealing failures for average silicones



DESCRIPTION	MFG#	PART #
White RTV Acetoxy 3 oz	31312	446006
Blue RTV Acetoxy 3 oz	31316	446008
Grey Oxime 3 oz	32327	446012
Black Oxime 3 oz	32329	446013



FILTER CHARGER OIL

K&N Air Filter Oil is the only oil specially formulated to work in combination with the cotton fabric in K&N Filtercharger elements providing a superior air filtration system. When used as directed, it quickly penetrates the filter pleats, where it remains suspended in the cotton fabric. Saturation is maintained until the element is cleaned with K&N Air Filter Cleaner. Sold each.

DESC	QTY/CS	MFG#	PART #
1/2 oz Pillow Pack	50	99-11312	5611312



K100 FUEL TREATMENT

RUN CLEANER, RUN STRONGER, RUN LONGER

K100 Fuel Treatments are proprietary formulations of complex engineered organic compounds developed to eliminate water in fuels, remove gums and varnishes and stabilize fuel, add lubricity and corrosion protection and boost cetane/octane ratings. Its ALL- IN ONE Chemistry is all you will need to keep your engines running right.

BENEFITS OF USING K100

- Prevents phase separation in ethanol blended gasoline
- Eliminates water and all water related problems
- Stabilizes fuel for up to two years, and keeps it fresh
- Increases Octane/Cetane ratings 1 1/2 to 2 points
- Replaces lost lubricity in LSD, ULSD and K-1 winter blends
- Reduces black smoke, unburned hydrocarbons, CO and particulate emissions
- Reduces maintenance costs and down time and extends engine life
- Cleans engines and fuel systems for better mileage, easier starts, smoother idle, more power and better acceleration



K100 D+

DIESEL FUEL TREATMENT

K100-D+ Diesel Fuel Treatment eliminates water in the fuel to prevent microbe growth and winter freeze-ups, improves fuel performance by altering the burn chemistry for more complete combustion, boosting the cetane, and reducing black smoke, pollutants and emissions, and cleans engines and fuel systems while adding lubricity for maximum engine performance and fuel system life.

DESCRIPTION	QTY/CS	PART #
8 oz Bottle	12	965013
32 oz Bottle	12	965014



K100 G+

GASOLINE FUEL TREATMENT W/ENHANCED STABILIZER FOR 2 & 4 CYCLE ENGINES

K100 G+ Gasoline Treatment eliminates water in the fuel to prevent winter freeze-ups and phase separation in E-10, and improves fuel performance by altering the burn chemistry for more complete combustion, boosting the octane, and reducing oil fumes and toxic emissions.

DESCRIPTION	QTY/CS	PART #
8 oz Bottle	12	965011
32 oz Bottle	12	965012



K100 MARINE FORMULA GAS

GASOLINE FUEL TREATMENT

Using proprietary formulations of organic compounds, this premium engineered product eliminates water in your boat and jet ski engines to stabilize fuel for up to two years. K100 is the only product that actually MAKES WATER BURN™ to enhance overall system performance. It wakes up your boat. Treats 20 gallons of fuel.

DESCRIPTION	QTY/CS	PART #
8 oz Bottle	10	965015
32 oz Bottle	10	965016



SYNTHETIC SNOWMOBILE TECHNIPLATE TC-W3

- This premium, power valve friendly, synthetic lubricant has been providing racers and enthusiasts with the best protection available for over three decades
- The smoke-free formula and great smell will ensure that the riders behind you will enjoy the quality of Klotz® as much as you're enjoying the performance benefits
- Exceeds NMMA TC-W3®, JASO FD, ISO-EGD and API TC low ash specifications for
- Certified warranty compliance in Ski Doo, Polaris, Yamaha, and Arctic Cat Snowmobiles - Not alcohol compatible
- Sold per bottle.

DESC	QTY/CS	MFG#	PART #
1 Quart	10	KL-215	KL215
1 Gallon	4	KL-216	KL216
5 GALLON PAIL	1	KL-2155PL	404027



2 CYCLE SUPER TECHNIPLATE RACING OIL

- Pure synthetic bases are blended with 20% BeNOL® Racing Castor Oil
- Provides engines the Clean Burn™ quality of Klotz® synthetic lubricants along with the exceptional film strength of castor oil
- Degummed castor oil reduces ring groove deposits and protects engines in high RPM and extreme heat applications
- Blends with methanol alcohol and gasoline
- Sold per bottle

DESC	QTY/CS	MFG#	PART #
1 Quart	10	KL-100	KL10
1 Gallon	4	KL-101	KL101



MOTORCYCLE TECHNIPLATE TC-2

Fully synthetic lubricant specifically designed to improve throttle response and overall performance of all motorcycle engines. Ash less, No-Smoke formula provides cleaner exhaust and reduced carbon deposits. Exceeds BIA/TC-W2 service ratings for warranty compliance. Not alcohol compatible. Sold per bottle.

DESC	QTY/CS	MFG#	PART #
1 Quart	10	KL-300	KL300



4-STROKE MOTORCYCLE RACING SYNTHETIC LUBRICANT

- Fully synthetic formula contains TechniPlate® Lubricity System® which provides load carrying capacity and film strength greater than petroleum and petroleum/synthetic blend lubricants
- Superior thermal transfer properties lowers engine temperatures
- Shear stable synthetic polymers give superior clutch/transmission protection and operation
- 32 fl. oz. Sold per bottle

DESC	QTY/CS	MFG#	PART #
10W-40	10	KL-840	KL840
20W-50	10	KL-850	KL850



KLOTZ BENOL® 2 CYCLE OIL

BeNOL®, the ultimate in 2-stroke lubricant when it comes to both protection and performance, is the choice of serious racers. Degummed and extra fortified for maximum reliability. BeNOL® provides twice the level of film strength and load carrying capacity of conventional castor oils. Blends with methanol alcohol and gasoline. Sold per bottle.

DESC	QTY/CS	MFG#	PART #
1 Gallon	4	BC-171	BC171
1 Quart	10	BC-172	BC172
1 Pint	10	BC-175	BC175



KLOTZ UPLON® FUEL LUBE

Klotz® Uplon® Fuel Lube provides upper cylinder and fuel pump lubrication. Protects the induction and fuel delivery systems from the dry, abrasive properties of methanol alcohol. Uplon® Fuel Lube increases horsepower by reducing power robbing friction. Unique seal conditioners help maintain constant fuel pressure and prevent lean-out conditions. Blends with methanol alcohol and gasoline. Sold per bottle.

DESC	QTY/CS	MFG#	PART #
1 Quart	10	KL-107	KL107



KLOTZ MX4® TECHNIPLATE® OIL

Klotz® MX4® is designed for use in the new generation of 4-stroke performance motorcycle and ATV engines. Use of this API and JASO Certified Lubricant exceeds manufacturers warranty requirements. TechniPlate® technology is an advanced synthetic lubricity system which contains precision-engineered lubricating molecules that protect engine components from molecular shearing and extreme heat. MX4® is specially formulated for thermal stability and reduced friction. Sold per bottle.

DESC	QTY/CS	MFG#	PART #
10W-40	10	KL-860	404001
15W-50	10	KL-880	404002



KLOTZ OCTANE BOOSTER

Klotz® Octane Booster is a concentrated tetraethyl lead substitute formulated to increase the octane rating of gasoline up to 10 numbers or more. Helps eliminate engine damaging detonation, spark knock, pre-ignition, and pinging from low octane gasoline. Modifies the burn speed and flash point of gasoline to create a stable combustion chamber flame front, maximizing performance and power. Stabilizes oxygenated gasoline to prevent leak-out conditions. Provides needed upper-cylinder lubrication that is missing in unleaded gasoline. For gasoline only. Sold each.



DESCRIPTION	QTY/CS	MFG#	PART #
6 oz	20	KL626	404028
16 oz	10	KL-602	KL62
1 Gallon		KL-628	KL628



KLOTZ NITRO RACING ADDITIVE

A custom blended nitro additive developed for gas or alcohol. Dyno tests report a power increase of up to 15%. Contains Koolinal, a guarding agent to reduce heat and pre-ignition. Sold each.



DESCRIPTION	QTY/CS	MFG#	PART #
16 oz	10	KL-600	KL60
1 Gallon		KL-640	KL640



KLOTZ CONTACT CLEANER

Klotz® Plug & Contact Cleaner® will safely and quickly clean and degrease all metal and aluminum surfaces, fouled spark plugs, carburetors, and other small parts. Nonconductor formula is safe to use on electrical systems, electric switches, connections, motors, starters, and alternators. Completely cuts through and removes carbon, oil, dirt, grease, tar, and adhesives without leaving a residue. Safe for use on engine parts, carburetors, brake parts, ignition parts, spark plugs, and engine sensors. Sold each.



DESCRIPTION	QTY/CS	MFG#	PART #
12.5 oz	10	KL-609	KL69



FABRIC FILTER OIL

Klotz® Fabric Air Filter Oil is for all street, off-road, and racing fabric K&N type air filter applications. Klotz® Fabric Air Filter Oil is easy to apply and improves air flow. Water resistant formula creates an oil barrier to trap micron sized particles that would normally find their way through air filters. Will not gum up and dry out. Sold each.



DESCRIPTION	QTY/CS	MFG#	PART #
15.25 oz	10	KL-607	KL607



FILTER CLEANER

Klotz® Filter Cleaner is for all street, off-road, and racing air filter applications. Removes dirt and oil from air filters for increased air flow and performance. Safe for use on all foam and K&N type fabric filters. Klotz® Filter Cleaner will dissolve and clean heavy buildup of dirt, grease, and oil from air filters without messy and unsafe solvents. Sold each.



DESCRIPTION	QTY/CS	MFG#	PART #
15.25 oz	10	KL-608	KL608



ASSEMBLY LUBE

TechniPlate Synthetic Assembly Lube provides needed lubrication during the critical first moments an engine runs. Coats engine components with a protection film to prevent molecular shearing and metal-to-metal contact. Rust inhibitors protect machined parts during storage. Sold per bottle.



DESCRIPTION	QTY/CS	MFG#	PART #
12 oz	10	KL-311	KL311



FOAM FILTER OIL

Klotz® Foam Air Filter Oil is for all street, off-road, and racing foam air filter applications. Foam Air Filter Oil is easy to apply and improves air flow. Super viscous formula forms an oil barrier to trap micron sized particles that would normally find their way through air filters. Will not gum up and dry out. Waterproof formula prevents clogging when wet. Sold each.



DESCRIPTION	QTY/CS	MFG#	PART #
15.25 oz	10	KL-606	KL606



OUTBOARD TECHNIPLATE® TC-W3

Premium, pure synthetic lubricant. Extremely high load carrying capacity for performance and racing outboards. Clean Burn™, No-Smoke Technology eliminates carbon and residue build-up. Provides fast, easy starting. Use of this lubricant provides certified warranty compliance and optimum protection. Exceeds NMMA TC-W3, JASO FD and ISO-EGD specifications for certified warranty compliance. Not alcohol compatible. Sold per bottle.

DESC	QTY/CS	MFG#	PART #
1 Quart	10	KL-332	404018
1 Gallon	4	KL-333	404019



SKICRAFT® TECHNIPLATE® TC-W3

Pure synthetic lubricant. Extremely high load carrying capacity for reduced engine wear. Clean Burn™, No-Smoke Technology eliminates carbon and residue build-up. Use of this lubricant provides certified warranty compliance and protection. Exceeds JASO FD, ISO-EGD, TC-W3, TC-W2, TC-W and API TC low ash specifications for certified warranty compliance. Not alcohol compatible. Sold per bottle.

DESCRIPTION	QTY/CS	MFG#	PART #
1 Quart	10	KL-306	404020
1 Gallon	4	KL-307	404021



50:1 TECHNIPLATE® TC-W3

2-stroke, pure synthetic lubricant. Extremely high load carrying capacity for reduced engine wear. Clean Burn™, No-Smoke Technology eliminates carbon and residue build-up. Exceeds JASO FD, ISO-EGD, TC-W3, TC-W2, TC-W and API TC low ash specifications for certified warranty compliance. Not alcohol compatible. Sold per bottle.

DESCRIPTION	QTY/CS	MFG#	PART #
1 Pint	10	KL-305	404022



JET PUMP LUBRICANT

Klotz® Jet Pump Lubricant exceeds manufacturers' warranty requirements for jet pump lubrication. Jet Pump contains TechniPlate® Synthetic Lubricity Systems to protect against expensive jet pump failures. Jet Pump is compatible with OEM oils. Sold per bottle.

DESCRIPTION	QTY/CS	MFG#	PART #
4 oz	20	KL-511	404017



KLOTZ FORK OIL

SNOWMOBILE - SHOCKS MOTORCYCLE/ATV - FORKS AND SHOCKS

Special friction-reducing formula developed for modern suspension technology, including cartridge and air-assisted forks from Showa®, KYB®, and Kayaba®. Anti-Foam and Anti-Fade additives reduce stiction and cavitation. Anti-wear seal conditioners extend fork seal and bushing life. 1 quart. Sold per bottle.

DESCRIPTION	QTY/CS	MFG#	PART #
5W	10	KL-505	KL505
10W	10	KL-510	KL510
15W	10	KL-515	KL515



R50® TECHNIPLATE®

R 50® synthetic lubricant was developed exclusively for use in Hi-RPM racing engines. TechniPlate® R 50® racing lubricity system protects engines from extreme heat and virtually eliminates engine wear. R 50® film strength is comparable to castor oil, but has the benefits of Clean Burn™ technology. Not alcohol compatible. Sold per bottle.

DESC	QTY/CS	MFG#	PART #
1 Pint	10	KL-102	KL102
1 Quart	10	KL-104	404023
1 Gallon	4	KL-105	404024

KLOTZ V-TWIN TECHNIPLATE® OIL

Multi-viscosity Klotz® American V-Twin Synthetic TechniPlate® Lubricant is custom-formulated for the Harley Davidson® air-cooled engine. Exceeds all warranty requirements for Harley Davidson® engines. Will not shear like petroleum oils and stays-in-grade even under the most stressful situations. The high power output and piston speeds of the V-Twin engine demand the protection Klotz® TechniPlate® advanced lubrication technology provides. 1 quart. Sold per bottle.



DESC	QTY/CS	MFG#	PART #
20W-50	10	KH-2050	404004
25W-60	10	KH-2560	404005
SAE 50	10	KH-50	404006
SAE 60	10	KH-60	404007
SAE 70	10	KH-70	404008

ATV/UTV SYNTHETIC ENGINE LUBRICANT W/ INTEGRATED TRANSMISSION 10W-40

Designed for off-road 4-stroke hi-performance ATV, Utility & Side by Sides with wet clutch integrated transmission. Developed for extreme loading stresses of off-road use. Provides extra film strength to protect engine parts from metal-to-metal contact. Famous Klotz Smell while protecting the environment with Klotz Clean Burn Technology™. Provides smoother, quieter clutch and transmission operation. Recommended for Arctic Cat, Can-Am, Honda, Kawasaki, Kymco, Suzuki and Yamaha. Sold per bottle.



DESC	QTY/CS	MFG#	PART #
1 Quart	10	ATV/UTV-1040	404014

ATV/UTV SYNTHETIC ENGINE LUBRICANT 0W-40

Designed for off-road 4-stroke hi-performance ATV, Utility & Side by Sides. Developed for extreme loading stresses of off-road use. Provides extra film strength to protect engine parts from metal-to-metal contact. Famous Klotz Smell while protecting the environment with Klotz Clean Burn Technology™. Recommended for Polaris ATV/UTV & John Deere. Sold per bottle.



DESC	QTY/CS	MFG#	PART #
1 Quart	10	ATV/UTV-040	404013



KLOTZ CHAIN LUBE SPRAY

Klotz® Hi-Performance Chain Lube contains ExtraTac™ Anti-Wear System for all street, off-road, and racing applications. Specially formulated for conventional and “O” ring type roller chains to provide the maximum level of lubrication and rust protection. Klotz® ExtraTac™ Anti-Wear System penetrates deeply to displace moisture and dirt and allow for maximum corrosion protection. Sold each.

DESCRIPTION	QTY/CS	PART #
15.5 oz	10	KL605



SIDE X SIDE SYNTHETIC ENGINE LUBRICANT

Recommended for Arctic Cat, Can-Am, Honda, Kawasaki, Kymco, Suzuki, Polaris and Yamaha side-by-side applications. Certified warranty compliant: JASO MA2, API SJ-SN. Designed for wet clutch integrated transmission, developed for extreme loading stresses of off-road use. Provides smoother, quieter clutch and transmission operation.

DESCRIPTION	QTY/CS	PART #
5W/50 1 Quart	10	KL802
10W/30 1 Quart	10	KL803
10W/40 1 Quart	10	KL804
10W/50 1 Quart	10	KL805
15W/50 1 Quart	10	KL806



FLEX DRIVE 30 TRANSMISSION LUBRICANT

Klotz® Flex Drive™ 30 TechniPlate® Synthetic Gear Lubricant is a low viscosity, extreme pressure 75W/80 lubricant for use in 2-stroke Motorcycle and ATV transmissions with a wet clutch. Replaces S.A.E. 20, 30 and 40W petroleum gear oils. Meets and exceeds manufacturer warranty requirements for Honda, Kawasaki, Yamaha, Suzuki and KTM transmissions and clutches. Klotz® Flex Drive™ 30 is engineered for enhanced thermal stability and to withstand the constant shearing stress in racing applications. TechniPlate® technology is an advanced synthetic lubricity system which contains precision lubricating and anti-shearing molecules that coat gears and clutch plates with a protective film to absorb shock and prevent metal to metal contact. Sold per bottle.

DESCRIPTION	QTY/CS	MFG#	PART #
30W 1 Quart	10	KL-506	KL506



KLOTZ V-TWIN GEAR AND CHAIN OIL

Klotz® American V-Twin Synthetic TechniPlate® Gear and Chain Case Lubricant is custom formulated for the Harley Davidson® Sportster Models. Exceeds all warranty requirements for Harley Davidson® engines. Use of this lubricant provides certified warranty compliance and protection. TechniPlate® technology reduces friction, absorbs gear shock loading and gear galling. 100% synthetic transmission lubricant offers improved thermal stability and contains pressure lubricity systems to withstand extreme shearing stress. Protects against wear and lowers transmission temperatures. Sold per bottle.

DESCRIPTION	QTY/CS	MFG#	PART #
1 Quart	10	KH-S80	404009



ATV/UTV FRONT/REAR END DIFFERENTIAL LUBRICANT 80W-90

Designed for off-road hi-performance ATV, Utility & Side by Sides. Developed for extreme loading stresses of off-road use. Provides extra gear protection in extreme shock loading conditions. Recommended for Arctic Cat, Can-Am, Honda, Kawasaki, Kymco, Suzuki and Yamaha. Sold per bottle.

DESC	QTY/CS	MFG#	PART #
1 Quart	10	KL-104	404023



KLOTZ V-TWIN PRIMARY CASE OIL

Klotz® American V-Twin Synthetic TechniPlate® Primary Chain Case Lubricant is custom formulated for the Harley Davidson® Big Twin Models. Exceeds all warranty requirements for Harley Davidson® engines. Use of this lubricant provides certified warranty compliance and protection. Penetrates deep into chain rollers to loosen stiff links and extend chain and sprocket life. Sold per bottle.

DESC	QTY/CS	MFG#	PART #
1 Quart	10	KH-1040	404003



KLOTZ V-TWIN TRANSMISSION OIL

Klotz® American V-Twin Synthetic TechniPlate® Hypoid Transmission Lubricant is custom formulated for the Harley Davidson® Big Twin Models. Exceeds all warranty requirements for Harley Davidson® engines. Use of this lubricant provides certified warranty compliance and protection. TechniPlate® technology reduces friction and absorbs gear shock loading and gear galling. Protects against wear and lowers transmission temperatures. 100% synthetic Hypoid transmission lubricant offers improved thermal stability and contains extreme pressure lubricity systems to withstand shearing stress. 1 quart. Sold per bottle.

DESC	QTY/CS	MFG#	PART #
80W-90	10	KH-GL90	404011
75W-140	10	KH-GL140	404012



KLOTZ FREE-GEAR ESTORLIN® 80W-90 HYPOID DIFFERENTIAL LUBRICANT

Free-Gear Estorlin® Hypoid Lubricants provide you with the best protection available, while ensuring you are not robbing yourself of horsepower. Estorlin® technology gives maximum protection in the lightest weight synthetic lubricant possible.

Used in standard, limited slip rear ends and marine lower units. NOT FOR TRANSMISSION. If you are looking for "WET" clutch application use KL506. Sold per bottle.

DESC	QTY/CS	MFG#	PART #
1 Quart	10	KE-990	KE990



KLOTZ CHAIN CASE LUBE

Klotz® Black Formula Hi-Performance Chain Case Lube contains graphite molecules for reduced friction and surface drag. Provides maximum power and performance in extreme hot and cold conditions. Penetrates deep into chain rollers to loosen stiff links and extend chain and sprocket life. Eliminates rust and corrosion on chains and sprockets. Sold per bottle.

DESCRIPTION	QTY/CS	PART #
12 oz	10	KL50



KLOTZ STORBILIZER

- Stabilizes ethanol and gasoline mixtures
- Helps prevent oxidation and corrosion
- Recommended for pre-mix or ethanol/gasoline blends
- Provides six to eight months protection
- Allows quick and easy start-ups following extended storage

DESCRIPTION	QTY/CS	PART #
1 Pint	10	KL613



KLOTZ ETHANOL GASOLINE PHASE SEPARATION® TREATMENT

- Promotes easier starting
- Helps avoid phase separation
- Helps burn off free water, moisture and condensation
- Provides three to six month protection
- Contains lubricity to prevent dry-out

DESCRIPTION	QTY/CS	MFG#	PART #
1 Pint	10	KL603	KL603



KLOTZ CANDLE

- Hand made by Maria Klotz
- The exclusive Klotz scented candle has the fragrance that you have come to know and love
- Burns up to 30 hours

DESCRIPTION	QTY/CS	PART #
8 oz. Tin		KL755



KLOTZ LUBRICANTS KLOTZ QUICK DETAILER (23OZ)

Klotz's Quick Detailer is a shine enhancer and protectant. Shines and protects paint, metal, glass and fiberglass. Quickly removes dust, fingerprints, smears, and light surface contaminants. Easily removed without leaving haze, streaks, or residue.

DESCRIPTION	QTY/CS	PART #
23 oz	10	404051



FOAMING CAR WASH

Klotz's new foaming system uses high-quality, biodegradable soap that gently lifts dirt and grime, leaving your car sparkling clean and gleaming like new. We know how important it is to keep your vehicle of choice looking pristine, and that's why we've brought you an advanced, eco-friendly car wash experience like no other.

DESCRIPTION	QTY/CS	PART #
1 Gallon	10	404060



ATV/UTV FRONT/REAR END DIFFERENTIAL LUBRICANT 80W/90

Designed for off-road hi-performance ATV, Utility & Side by Sides. Developed for extreme loading stresses of off-road use. Provides extra gear protection in extreme shock loading conditions. Recommended for Artic Cat, Can-Am, Honda, Kawasaki, Kymco, Suzuki and Yamaha.

DESCRIPTION	QTY/CS	PART #
80W/90, 10 quart bottle case	10	404015



SNOWX4® PURE ESTORLIN® ENGINE LUBRICANT

Meets and exceeds API and JASO requirements for complete warranty compliance for all leading snowmobile manufacturers, including Yamaha®, Ski-Doo®, Arctic Cat®, and Polaris®. PURE ESTORLIN® technology extracts peak horsepower. Formulated for cold weather starts at -48°F, with enhanced flowability and reduced friction, providing Less Drag...More Power™

DESCRIPTION	QTY/CS	PART #
0W/30, 1 quart bottle	10	404025



ATV/UTV SYNTHETIC ENGINE LUBRICANT

Recommended for Polaris® ATV/UTV engines with separate transmission. Meets and exceeds warranty requirements for compliance and protection. Developed for extreme loading stresses of off-road use. Lowers engine oil temperature. Increases acceleration and horsepower.

DESCRIPTION	QTY/CS	PART #
5W/50 - Quart	10	404029



POLARIS SIDE-BY-SIDE OIL CHANGE KIT

Klotz® Side-By-Side Oil Change Kits come with just the right amount of lubricant, no more no less. Developed for the extreme loading of off-road use while providing smoother, quieter clutch and transmission operation. Top-tier additive package prevents wear, oxidation and corrosion. Detergents and dispersants maintain cleanliness and mitigate deposit formation.

DESCRIPTION	QTY/CS	MFG#	PART #
KU-100 5W-50	10	KU-100	404031
KU-101 10W-50	10	KU-101	404032
KU-108 5W-50	10	KU-108	404057
KU-110 10W-40	10	KU-110	404059



POLARIS 2019+ TURBO/PRO SIDE-BY-SIDE OIL CHANGE KIT

Klotz® Side-By-Side Oil Change Kits come with just the right amount of lubricant, no more no less. Developed for the extreme loading of off-road use while providing smoother, quieter clutch and transmission operation. Top-tier additive package prevents wear, oxidation and corrosion. Detergents and dispersants maintain cleanliness and mitigate deposit formation.

DESCRIPTION	QTY/CS	MFG#	PART #
KU-102 5W-50	10	KU-102	404033
KU-103 10W-50	10	KU-103	404034



CAN-AM SIDE-BY-SIDE OIL CHANGE KIT

Klotz® Side-By-Side Oil Change Kits come with just the right amount of lubricant, no more no less. Developed for the extreme loading of off-road use while providing smoother, quieter clutch and transmission operation. Top-tier additive package prevents wear, oxidation and corrosion. Detergents and dispersants maintain cleanliness and mitigate deposit formation.

DESCRIPTION	QTY/CS	MFG#	PART #
KU-104 10W-40	10	KU-104	404035
KU-105 10W-50	10	KU-105	404036



YAMAHA RMAX2 AND RMAX4 SIDE-BY-SIDE OIL CHANGE KIT

Klotz® Side-By-Side Oil Change Kits come with just the right amount of lubricant, no more no less. Developed for the extreme loading of off-road use while providing smoother, quieter clutch and transmission operation. Top-tier additive package prevents wear, oxidation and corrosion. Detergents and dispersants maintain cleanliness and mitigate deposit formation.

DESCRIPTION	QTY/CS	MFG#	PART #
KU-106 10W-40	10	KU-106	404037



YAMAHA YXZ1000R SIDE-BY-SIDE OIL CHANGE KIT

Klotz® Side-By-Side Oil Change Kits come with just the right amount of lubricant, no more no less. Developed for the extreme loading of off-road use while providing smoother, quieter clutch and transmission operation. Top-tier additive package prevents wear, oxidation and corrosion. Detergents and dispersants maintain cleanliness and mitigate deposit formation.

DESCRIPTION	QTY/CS	MFG#	PART #
KU-106 10W-40	10	KU-107	404038



EVOLUTION SPORTSTER® 1986-2022 OIL CHANGE KIT

We get it. You don't have a ton of time to waste on changing your oil. You've got better places to be, bigger things to see. That's why we crafted the Klotz® No Bull\$@!X Oil Change Kit for the Harley-Davidson® V-Twin engine. Our premiere class of synthetic lubricants outperforms every other oil on the market. Pushing the limits without top class choice. Increase performance, save money, and stop wasting time.

DESCRIPTION	QTY/CS	MFG#	PART #
Basic 4 Quart Synthetic Engine Oil and Chrome Filter Kit	10	KH-105	404039
Premium Complete 4 Quart Synthetic Oil Service Kit	10	KH-104	404040
Basic 5 Quart Synthetic Engine Oil and Chrome Filter Kit	10	KH-111	404041
Premium Complete 5 Quart Synthetic Oil Service Kit	10	KH-110	404042



EVOLUTION BIG TWIN 1984-1999 SYNTHETIC OIL CHANGE KIT

We get it. You don't have a ton of time to waste on changing your oil. You've got better places to be, bigger things to see. That's why we crafted the Klotz® No Bull\$@!X Oil Change Kit for the Harley-Davidson® V-Twin engine. Our premiere class of synthetic lubricants outperforms every other oil on the market. Pushing the limits without top class choice. Increase performance, save money, and stop wasting time.

DESCRIPTION	QTY/CS	MFG#	PART #
Basic 4 Quart Synthetic Engine Oil and Chrome Filter Kit	10	KH-103	404043
Premium Complete 4 Quart Synthetic Oil Service Kit	10	KH-102	404044
Basic 5 Quart Synthetic Engine Oil and Chrome Filter Kit	10	KH-107	404045
Premium Complete 5 Quart Synthetic Oil Service Kit	10	KH-106	404046



TWIN CAM 1999-2018 AND MILWAUKEE-EIGHT 2017-2024 SYNTHETIC OIL CHANGE KITS



We get it. You don't have a ton of time to waste on changing your oil. You've got better places to be, bigger things to see. That's why we crafted the Klotz® No Bull\$@!X Oil Change Kit for the Harley-Davidson® V-Twin engine. Our premiere class of synthetic lubricants outperforms every other oil on the market. Pushing the limits without top class choice. Increase performance, save money, and stop wasting time.

DESCRIPTION	QTY/CS	MFG#	PART #
Basic 4 Quart Synthetic Engine Oil and Chrome Filter Kit	10	KH-101	404047
Premium Complete 4 Quart Synthetic Oil Service Kit	10	KH-100	404048
Basic 5 Quart Synthetic Engine Oil and Chrome Filter Kit	10	KH-109	404049
Premium Complete 5 Quart Synthetic Oil Service Kit	10	KH-108	404050



INDIAN® SCOUT OIL CHANGE KIT

We get it. You don't have a ton of time to waste on changing your oil. You've got better places to be, bigger things to see. That's why we crafted the Klotz® No Bull\$@!X Oil Change Kit for the V-Twin engine. Our premiere class of synthetic lubricants outperforms every other oil on the market. Pushing the limits without top class choice. Increase performance, save money, and stop wasting time.

DESCRIPTION	QTY/CS	MFG#	PART #
4 Quart Synthetic Oil Service Kit	10	KH-120	404052



INDIAN® FTR OIL CHANGE KIT

We get it. You don't have a ton of time to waste on changing your oil. You've got better places to be, bigger things to see. That's why we crafted the Klotz® No Bull\$@!X Oil Change Kit for the V-Twin engine. Our premiere class of synthetic lubricants outperforms every other oil on the market. Pushing the limits without top class choice. Increase performance, save money, and stop wasting time.

DESCRIPTION	QTY/CS	MFG#	PART #
4 Quart Synthetic Oil Service Kit	10	KH-121	404053



INDIAN® POWERPLUS OIL CHANGE KIT

We get it. You don't have a ton of time to waste on changing your oil. You've got better places to be, bigger things to see. That's why we crafted the Klotz® No Bull\$@!X Oil Change Kit for the V-Twin engine. Our premiere class of synthetic lubricants outperforms every other oil on the market. Pushing the limits without top class choice. Increase performance, save money, and stop wasting time.

DESCRIPTION	QTY/CS	MFG#	PART #
4 Quart Synthetic Oil Service Kit	10	KH-122	404054



INDIAN® THUNDERSTROKE OIL CHANGE KIT 15W/60

We get it. You don't have a ton of time to waste on changing your oil. You've got better places to be, bigger things to see. That's why we crafted the Klotz® No Bull\$@!X Oil Change Kit for the V-Twin engine. Our premiere class of synthetic lubricants outperforms every other oil on the market. Pushing the limits without top class choice. Increase performance, save money, and stop wasting time.

DESCRIPTION	QTY/CS	MFG#	PART #
6 Quart Synthetic Engine Oil and Chrome Filter Kit	10	KH-123	404055



POLARIS VICTORY OIL CHANGE KIT 20W/40

We get it. You don't have a ton of time to waste on changing your oil. You've got better places to be, bigger things to see. That's why the Klotz® No Bull\$@!X Oil Change Kit was crafted to outperform every other oil on the market. Increase performance, save money, and stop wasting time. • Klotz® V-Twin Oil Change Kits come with just the right amount of lubricant, no more no less.

DESCRIPTION	QTY/CS	MFG#	PART #
5-1/2 Quart Synthetic Oil Service Kit for Victory®	10	KH-124	404056



KAWASAKI SIDE-BY-SIDE OIL CHANGE KIT 10W-40

Synthetic Oil Service Kit for Kawasaki® MORE RIDING. LESS MAINTAINING. We get it. You don't have a ton of time to waste on changing your oil. You've got better places to be, bigger things to see. That's why the Klotz® Side-by-Side Oil Change Kit was crafted to outperform every other oil on the market. Increase performance, save money, and stop wasting time. Klotz® Oil Change Kits come with just the right amount of lubricant, no more no less.

DESCRIPTION	QTY/CS	MFG#	PART #
4 Quart Synthetic Oil Service Kit for Kawasaki®	10	KU-109	404058



MOTORCYCLE TECHNIPLATE® SYNTHETIC LUBRICANT

API TC, TC-W, TC-W3 certified, meets JASO FD and ISO-L-EGD requirements for complete warranty compliance. Identifiable Klotz red color and racy scent. Improves throttle response. Clean Burn Technology for low smoke and helps prevent plug fouling. Extreme film strength protects engine parts from metal-to-metal contact. High-temperature stability reduces power valve deposits. Pre-mix or oil injection.

DESCRIPTION	QTY/CS	MFG#	PART #
1 Quart Bottle	10	KL-302	KL302



KLOTZ™ CANDLE

Hand made by Maria Klotz. The exclusive Klotz™ scented candle has the fragrance that you have come to know and love. This 8 ounce candle burns up to 30 hours.

DESCRIPTION	QTY/CS	MFG#	PART #
BeNOL Candle	10	KL-756	KL756



KLOTZ JET PUMP LUBE, 4 OUNCE

TechniPlate® Synthetic Technology meets and exceeds the manufacturer's warranty. Anti-Foam additives maintain lubrication efficiency. Preserves seals for reduced maintenance and downtime. Protects against wear and lowers bearing temperatures. Contains a red leak indicator. No burnt OEM smell.

DESCRIPTION	QTY/CS	MFG#	PART #
4oz Bottle	10	KL-551	404017



KLOTZ 10W40 SYNTHETIC V-TWIN ENGINE OIL

Custom-formulated for Harley-Davidson and Buell V-twin air-cooled engines, this oil meets API-SH/CG-4 standards, reduces temperature and detonation, and provides high-temperature film strength for superior anti-wear protection.

DESCRIPTION	QTY/CS	MFG#	PART #
SAE 10W/40 32 oz	10	KH-1040	404003



LEAR CHEMICAL RESEARCH CORPORATION



CORROSION BLOCK LIQUID

Corrosion Block 4L Refill stops corrosion fast with a clear, non-toxic, non-flammable formula. Penetrates deeply and leaves a clean, protective film.

DESCRIPTION	QTY/CS	PART #
4L / 1 Gal Liquid	6	650417
32oz Liquid	6	650419



ACF-50 AEROSOL

ACF-50 stops active corrosion with one application. Safe for electronics and electrical components, it also lubricates moving parts. Non-flammable, virtually non-toxic, and ideal for long-lasting protection.

DESCRIPTION	QTY/CS	PART #
13oz Aerosol	6	650426



CORROSION BLOCK AEROSOL

Nonconductive and safe for all circuits, rubbers, and plastics. Provides 6–12 months of protection. Ideal for preventative maintenance.

DESCRIPTION	QTY/CS	PART #
12oz Aerosol	6	650418



ACF-50 LIQUID SPRAY

Originally developed for aircraft, ACF-50 kills existing corrosion on contact and prevents new corrosion from forming. It neutralizes road salt, leaves a clear, non-greasy barrier, and won't trap moisture. Safe for use on all motorcycle parts (except brakes), including electrical components. Ideal as external fogging oil for seasonal storage.

DESCRIPTION	QTY/CS	PART #
32oz Spray Pump	6	650427



CORROSION BLOCK GREASE

Corrosion Block Grease is a compound designed to protect your equipment from corrosion in the most demanding environments. It was formulated to handle extreme temperatures and outperforms most lithium and synthetic greases.

DESCRIPTION	QTY/CS	PART #
2oz Grease Tube	6	650421
3oz Grease Cartridge	6	650422
14oz Grease Cartridge	6	650423
16oz Grease Tub	6	650424



HAND HELD SPRAY

ACF-50 is a non-toxic, non-flammable anti-corrosion spray safe for all metals and electronics. It forms a clear, ultra-thin, non-greasy barrier that neutralizes road salt, won't trap moisture, and protects for up to 12 months. Safe for use anywhere on your machine—just avoid brakes and rotors.

DESCRIPTION	QTY/CS	PART #
Hand Held Spray System	6	650429



ACF-50 LIQUID

ACF-50 is a non-toxic, non-flammable anti-corrosion spray safe for all metals and electronics. It leaves a clear, non-greasy film that neutralizes road salt, prevents moisture buildup, and protects for up to 12 months.

DESCRIPTION	QTY/CS	PART #
4L / 1 Gal Liquid	6	650417



DETAILING KIT



This smaller kit contains our popular Spray Cleaner & Polish in a 5oz. can and one 16"x16" microfiber detailing cloth in a convenient package. Fits easily into motorcycle saddle bags so you can take it along with you on that weekend trip or to the show across town.

DESC	QTY/CS	MFG#	PART #
Roadside Detailing Kit	1	0696	650199
Quick Detailing Kit	1	0697	650201



POLY WAX

Liquid Performance Premium Poly-Wax with its polymer based formula provides long lasting protection from dirt, road salts, detergents and oxidation. This easy to use formula delivers a deep, wet-looking high-gloss shine without the hard work and messy white residue of traditional waxing.

DESC	QTY/CS	MFG#	PART #
8 oz	12	0770	650206



PREMIUM METAL POLISH

Cleans, polishes and preserves most metal surfaces. Works great on chrome, aluminum, brass, nickel, stainless steel, bronze, copper, magnesium, platinum and more.

DESC	QTY/CS	MFG#	PART #
8 oz	12	0478	650200



POWERSPORTS ATV & UTV WASH

Liquid Performance Premium ATV/UTV Wash is formulated to remove the tough stuff that other cleaners can't. Liquid Performance Premium ATV/UTV Wash penetrates dirt, mud, manure or whatever else you can get into on the track, in the woods, or on the farm and leaves your ATV/UTV looking showroom clean. It's safe for all finishes when used as directed. Biodegradable and non-corrosive.

DESC	QTY/CS	MFG#	PART #
32 oz	4	0011	650178



PAINT POLISH

Liquid Performance Premium Paint Polish is a buffered swirl mark reducer and gloss enhancing polish. Great for restoring full gloss after compounding or to remove fine scratches, swirl marks or light oxidation. Apply by hand or machine. Contains no silicone, fillers or waxes and is clearcoat safe.

DESC	QTY/CS	MFG#	PART #
8 oz	12	0769	650203



POWERSPORTS STREET BIKE WASH

From Harleys to Sport Bikes, Liquid Performance Premium Street Bike Wash has got you covered with a secret formula that removes grease, bugs, dirt and road grime better than any of the competitors. With its spray on, rinse off, no scrub formula you will be out cruising while the other guys are still scrubbing. Safe for all bike surfaces including windshields when used as directed. Non-corrosive and biodegradable.

DESC	QTY/CS	MFG#	PART #
32 oz	4	0013	650184



2 STROKE OIL



SNOWMOBILE MOTOR OIL 2T PRO RACE

Fully synthetic high-performance 2-stroke motor oil developed and tested on racing machines. Ensures maximum performance and protection of the engine in all operating conditions. Outstanding lubrication and engine cleanliness, excellent friction and minimum wear as well as less smoke.

This oil improves the riding experience!

- reduces smoke formation and lowers emissions
- high wear resistance
- good corrosion protection
- residue-free combustion
- self mixing
- high thermal stability

SIZE	QTY/CS	MFG #	PART #
1-L	6	20144	746068
4-L	4	20146	746038



MOTORBIKE 2T SYNTH OFFROAD RACE

Fully synthetic high-performance 2-stroke motor oil developed and tested on racing machines. Ensures maximum performance and protection of the engine in all operating conditions. Outstanding lubrication and engine cleanliness, excellent friction behavior and minimized wear as well as less smoke. This oil improves the riding experience!

- good corrosion protection
- high wear resistance
- residue-free combustion
- self mixing
- high thermal stability
- prevents build-up of deposits

SIZE	QTY/CS	MFG #	PART #
1-L	6	20178	746033
4-L	4	20180	746058

4 STROKE OIL



ATV 4T MOTOR OIL SAE 5W-50

Fully synthetic high-performance motor oil, developed and tested on racing machines. Ensures maximum performance and protection even in extreme operating conditions. Provides maximum engine cleanliness, reduced friction and minimum wear with smooth clutch operation, and effortless gear shift resulting in complete riding satisfaction!

- good corrosion protection
- high wear resistance
- residue-free combustion
- self mixing
- high thermal stability
- prevents build-up of deposits

SIZE	QTY/CS	MFG #	PART #
1-L	6	20212	746044
4-L	4	20214	746063

MOTORBIKE 4T SAE 10W-40 STREET



Fully synthetic high-performance motor oil provides optimum performance and engine protection in all operating conditions. Ensures outstanding engine cleanliness, excellent friction behavior and minimum wear together with perfect clutch operation, and smooth gear shifting.

- outstanding engine cleanliness
- guarantees low oil consumption
- especially suitable for wet clutches
- high shear stability
- high wear resistance
- ideal with catalytic converters
- optimum stability to aging
- optimum lubrication under all operating conditions

SIZE	QTY/CS	MFG #	PART #
1-L	6	20054	746042
4-L	4	20056	746040
20-L	1	20302	746067

MOTORBIKE 4T SAE 10W-30 STREET



Fully synthetic high-performance motor oil provides optimum performance and engine protection in all operating conditions. Ensures outstanding engine cleanliness, excellent friction behavior and minimum wear together with perfect clutch operation, and smooth gear shifting.

- outstanding engine cleanliness
- excellent shear stability
- guarantees low oil consumption
- especially suitable for wet clutches
- high wear resistance
- ideal with catalytic converters
- optimum stability to aging
- optimum lubrication under all operating conditions

SIZE	QTY/CS	MFG #	PART #
1-L	6	20418	746065
4-L	4	20420	746060

MOTORBIKE 4T SAE 15W-50 STREET



Fully synthetic high-performance motor oil provides optimum performance and engine protection in all operating conditions. Ensures outstanding engine cleanliness, excellent friction behavior and minimum wear together with perfect clutch operation, and smooth gear shifting.

- outstanding engine cleanliness
- guarantees low oil consumption
- especially suitable for wet clutches
- high shear stability
- high wear resistance
- ideal with catalytic converters
- optimum stability to aging
- optimum lubrication under all operating conditions

SIZE	QTY/CS	MFG #	PART #
1-L	6	20058	746035
4-L	4	20060	746034

MOTORBIKE 4T SAE 20W-50 STREET



High quality mineral-based motor oil for ideal behavior and engine protection in all operating conditions. Provides reliable lubrication, optimum noise suppression and low wear together with perfect clutch function and smooth shifting.

- excellent cleaning effect
- low evaporation loss
- guarantees low oil consumption
- especially suitable for wet clutches
- high shear stability
- high wear resistance
- ideal with catalytic converters
- miscible with all commercially available motor oils
- optimum stability to aging
- universal application
- prevents black sludge
- very good dispersion properties
- outstanding oil film strength

SIZE	QTY/CS	MFG #	PART #
1-L	6	20062	746053
4-L	4	20064	746055

MOTORBIKE 4T SAE 5W-40 HC STREET



Fully synthetic high-performance motor oil provides optimum performance and engine protection in all operating conditions. Ensures outstanding engine cleanliness, excellent friction behavior and minimum wear together with perfect clutch operation, and smooth gear shifting.

- outstanding engine cleanliness
- guarantees low oil consumption
- especially suitable for wet clutches
- high shear stability
- high wear resistance
- ideal with catalytic converters
- optimum stability to aging
- optimum lubrication under all operating conditions

SIZE	QTY/CS	MFG #	PART #
1-L	6	20412	746036
4-L	4	20414	746041
20-L	1	20416	746072

MOTORBIKE 4T SYNTH 5W-40 STREET RACE



Fully synthetic high-performance motor oil, developed and tested on racing machines. Ensures maximum performance and protection even in extreme operating conditions. Provides maximum engine cleanliness with reduced friction and minimum wear, smooth clutch operation, and effortless gear shift resulting in complete riding satisfaction!

- excellent wear resistance
- excellent shear stability
- guarantees low oil consumption
- especially suitable for wet clutches
- high engine cleanliness
- ideal with catalytic converters
- optimum stability to aging
- optimum lubrication under all operating conditions

SIZE	QTY/CS	MFG #	PART #
1-L	6	20074	746046
4-L	4	20076	746039
20-L	1	20304	746077

MOTORBIKE 4T SAE 10W-40



High quality mineral-based motor oil for ideal behavior and engine protection in all operating conditions. Provides reliable lubrication, optimum noise suppression and low wear together with perfect clutch function and smooth shifting.

- outstanding engine cleanliness
- guarantees low oil consumption
- especially suitable for wet clutches
- high shear stability
- high wear resistance
- ideal with catalytic converters
- optimum stability to aging
- optimum lubrication under all operating conditions

SIZE	QTY/CS	MFG #	PART #
1-L	6	20190	746045
4-L	4	20192	746059
20-L	1	20194	746070

MOTORBIKE 4T SYNTH SAE 10W-50 STREET RACE



Fully synthetic high-performance motor oil, developed and tested on racing machines. Ensures maximum performance and protection even in extreme operating conditions. Provides maximum engine cleanliness with reduced friction and minimum wear, smooth clutch operation, and effortless gear shift resulting in complete riding satisfaction!

- excellent wear protection
- guarantees low oil consumption
- especially suitable for wet clutches
- high shear stability
- ideal with catalytic converters
- optimum stability to aging
- optimum lubrication under all operating conditions

SIZE	QTY/CS	MFG #	PART #
1-L	6	20066	746052
4-L	4	20068	746049
20-L	1	20305	746073

MOTORBIKE 4T SAE 10W-40 OFFROAD

Fully synthetic high-performance motor oil provides optimum performance and engine protection in all operating conditions. Ensures outstanding engine cleanliness, excellent friction behavior and minimum wear together with perfect clutch operation, and smooth gear shifting.

- outstanding engine cleanliness
- guarantees low oil consumption
- especially suitable for wet clutches
- high resistance to aging
- high shear stability
- high wear resistance
- ideal with catalytic converters
- optimum lubrication under all operating conditions

SIZE	QTY/CS	MFG #	PART #
1-L	6	20082	746047
4-L	4	20084	746061
20-L	1	20306	746078



MOTORBIKE 4T SYNTH SAE 10W-60 STREET RACE

Fully synthetic high-performance motor oil, developed and tested on racing machines. Ensures maximum performance and protection even in extreme operating conditions. Provides maximum engine cleanliness with reduced friction and minimum wear, smooth clutch operation, and effortless gear shift resulting in complete riding satisfaction!

- outstanding engine cleanliness
- increases lubricating
- excellent wear protection
- suitable for wet clutches
- low evaporation loss
- guarantees low oil consumption
- ideal with catalytic converters
- miscible with all commercially available motor oils
- optimum stability to aging

SIZE	QTY/CS	MFG #	PART #
1-L	6	20070	746048
4-L	4	20072	746066



MOTORBIKE 4T SYNTH SAE 10W-50 OFFROAD RACE

Fully synthetic high-performance motor oil, developed and tested on racing machines. Ensures maximum performance and protection even in extreme operating conditions. Provides maximum engine cleanliness, reduced friction and minimum wear with smooth clutch operation, and effortless gear shift resulting in complete riding satisfaction!

- outstanding engine cleanliness
- excellent wear protection
- guarantees low oil consumption
- especially suitable for wet clutches
- high resistance to aging
- high shear stability
- optimum lubrication in extreme operating conditions

SIZE	QTY/CS	MFG #	PART #
1-L	6	20078	746032
4-L	4	20080	746057



MOTORBIKE 4T SAE 10W-60 OFFROAD RACE

Fully synthetic high-performance motor oil, developed and tested on racing machines. Ensures maximum performance and protection even in extreme operating conditions. Provides maximum engine cleanliness, reduced friction and minimum wear with smooth clutch operation, and effortless gear shift resulting in complete riding satisfaction!

- outstanding engine cleanliness
- excellent wear protection
- guarantees low oil consumption
- especially suitable for wet clutches
- high shear stability
- ideal with catalytic converters
- optimum stability to aging
- optimum lubrication in extreme operating conditions

SIZE	QTY/CS	MFG #	PART #
1-L	6	20186	746062
4-L	4	20188	746069





SNOWMOBIL MOTOROIL OW-40



Fully synthetic low-friction motor oil. Ensures the fastest oil penetration of the engine and optimum lubrication starting with the first turn of the engine. Has low viscosity and high shear stability thanks to synthetic base oils with advanced additive technology. Reliably prevents deposits, reduces frictional losses of the engine and contributes

- outstanding engine cleanliness
- extremely low evaporation loss
- excellent wear protection
- outstanding lubrication reliability
- tested for the use with catalytic converters
- optimum oil pressure under all operating conditions
- instant lubrication after cold start
- outstanding high temperature stability

SIZE	QTY/CS	MFG #	PART #
1-L	6	20148	746050

SNOWBIKE MOTOR OIL SAE OW-40



Fully synthetic low-friction motor oil designed for quick lubrication on cold start. The combination of high quality synthetic base oils together with an advanced additive package produces a low viscosity motor oil with high shear stability. This high-quality blend prevents engine deposits. Engine wear is reduced to a minimum thanks to low friction ...

- outstanding engine cleanliness
- extremely low evaporation loss
- excellent wear protection
- outstanding lubrication reliability
- ideal with catalytic converters
- optimum oil pressure under all operating conditions
- instant lubrication after cold start
- outstanding high temperature stability

SIZE	QTY/CS	MFG #	PART #
1-L	6	20356	746043
4-L	4	20358	746051

GEAR OIL

MOTORBIKE GEAR OIL SAE 75W-90



Fully Synthetic, GL5 high-performance extreme-pressure gear oil. Facilitates smooth and precise shifting even in extreme conditions, provides excellent wear protection properties and ideal viscosity-temperature behavior.

- excellent wear protection
- guarantees smooth gearshifting
- guarantees low fuel consumption
- good corrosion protection
- high efficiency
- reduces transmission noise
- wide viscosity range

SIZE	QTY/CS	MFG #	PART #
1-L	6	20086	746026

MOTORBIKE GEAR OIL SAE 75W-140 (GL5)



Fully Synthetic, GL5 high-performance extreme-pressure gear oil. Facilitates smooth and precise shifting even in extreme conditions, provides excellent wear protection properties and ideal viscosity-temperature behavior.

- excellent wear resistance
- outstanding corrosion protection
- reduces transmission noise
- wide viscosity range

SIZE	QTY/CS	MFG #	PART #
1-L	6	20088	746028



MARINE PWC OIL 10W-40

High-performance motor oil based on synthetic technology. The special additive package ensures maximum engine performance and ideal wear protection. Guarantees the best possible lubrication, outstanding engine cleanliness and excellent friction values for wet clutches, even at high speeds. Satisfies or exceeds the requirements and specifications of the leading engine manufacturers.

SIZE	QTY/CS	MFG #	PART #
1 Liter	12	20528	746289
4 Liter	12	20530	746290



MOTORBIKE HD SYNTH 20W-50 STREET

Fully synthetic motor oil tailored for use in air and water-cooled 4-stroke motorbike engines, especially suitable for Harley Davidsons. Selected base oils and high-quality additive components ensure optimum lubrication, outstanding engine cleanliness and excellent friction values in all operating conditions.

For a large number of Harley Davidson V-twin engines which specify a synthetic motor oil of 20W-50 viscosity. Exceptionally well-suited for use with or without a wet clutch.

SIZE	QTY/CS	MFG #	PART #
20L	12	22118	746291



DUAL CLUTCH TRANSMISSION OIL 8100

High-performance oil based on HC synthetic base oils and a powerful combination of additives. Achieves excellent clutch performance through extremely shear stable viscosity index improvers, advanced anti-wear additives and stable friction modifiers. Also suitable for dual clutch transmissions, which have a common oil supply for clutch, synchronizer, gear set and hydraulic control.

SIZE	QTY/CS	MFG #	PART #
1 Liter	12	20044	746308

FORK OIL



MOTORBIKE FORK OIL SAE 5W LIGHT

Full synthetic, low-viscosity fork or shock-absorber oil. Unique formulation prevents premature shear loss and provides full performance even after extended usage. Prevents foaming and maintains seals to prevent leaks. Long service life in combination with good corrosion and wear protection.

- lasting corrosion protection
- increases driving safety
- high wear resistance
- prevents seals from swelling
- prevents foam formation
- exceptionally sensible responsiveness can be used up to fork oil requirement SAE 2.5W with regard to viscosity and viscosity characteristics

SIZE	QTY/CS	MFG #	PART #
1-L	6	20094	746018
20-L	4	20402	746022



MOTORBIKE FORK OIL SAE 7.5W MEDIUM/LIGHT

Full synthetic, medium/light viscosity fork or shock-absorber oil. Unique formulation prevents premature shear loss and provides full performance even after extended usage. Prevents foaming and maintains seals to prevent leaks. Long service life in combination with good corrosion and wear protection.

- increases driving safety
- good corrosion protection
- high wear resistance
- prevents seals from swelling
- prevents foam formation

SIZE	QTY/CS	MFG #	PART #
1-L	6	20098	746020
20-L	4	20403	746024



MOTORBIKE FORK OIL SAE 10W MEDIUM

Full synthetic, medium-viscosity fork or shock-absorber oil. Unique formulation prevents premature shear loss and provides full performance even after extended usage. Prevents foaming and maintains seals to prevent leaks. Long service life in combination with good corrosion and wear protection.

- good corrosion protection
- high wear resistance
- prevents seals from swelling
- prevents foam formation
- better drivability

SIZE	QTY/CS	MFG #	PART #
1-L	6	20092	746019
20-L	4	20404	746023



MOTORBIKE FORK OIL SAE 15W HEAVY

Full synthetic, high-viscosity fork or shock-absorber oil. Unique formulation prevents premature shear loss and provides full performance even after extended usage. Prevents foaming and maintains seals to prevent leaks. Long service life in combination with good corrosion and wear protection.

- lasting corrosion protection
- increases driving safety
- high wear resistance
- prevents seals from swelling
- prevents foam formation

SIZE	QTY/CS	MFG #	PART #
1-L	6	20096	746021
20-L	4	20405	746025

SHOCK OIL



MOTORBIKE SHOCK ABSORBER OIL RACE

Fully synthetic shock absorber oil. Prevents deposit build-up while reducing friction and wear. Foaming is prevented even during extreme conditions. The unique formulation allows better handling and rider feedback which allows easier suspension tuning. Fluid color is blue.

- increases driving safety
- outstanding viscosity stability
- outstanding corrosion protection
- high wear resistance
- very compatible with seals
- prevents build-up of deposits
- prevents foam formation

SIZE	QTY/CS	MFG #	PART #
1-L	6	20290	746027
20-L	4	20292	746030



MOTORBIKE SHOCK ABSORBER OIL

Mineral based shock absorber oil. Prevents deposit build-up while reducing friction and wear. Foaming is prevented even during extreme conditions. The unique formulation allows better handling and rider feedback which allows easier suspension tuning.

- increases driving safety
- outstanding viscosity stability
- outstanding corrosion protection
- high wear resistance
- very compatible with seals
- prevents build-up of deposits
- prevents foam formation

SIZE	QTY/CS	MFG #	PART #
1-L	6	20294	746029
20-L	4	20293	746031

ADDITIVES



MOTORBIKE 4T BIKE-ADDITIVE (FUEL)

Removes deposits from the fuel system, valves, spark plugs and the combustion chamber while preventing new deposit formation. Improves engine performance and lowers emissions. Provides corrosion protection throughout and prevents carburetor icing.

- optimizes engine performance
- prevents corrosion in the fuel system
- reduces residue
- environmentally friendly
- increases operational reliability
- for carburetor and fuel-injection engines
- highly economical
- reduces the risk of knocking combustion
- normalizes fuel consumption and exhaust emissions

SIZE	QTY/CS	MFG #	PART #
0.08-Liter	6	20142	746079
0.125-Liter	4	20048	746086



MOTORBIKE SPEED ADDITIVE (FUEL)

A unique, state-of-the-art combination of acceleration-enhancing, cleaning, dispersing and material-protecting additives. Easy engine start, smoother running and better throttle response are the effects.

- higher performance gain
- improves acceleration
- cleans the fuel system
- protects fuel against oxidation and aging
- prevents corrosion in the fuel system
- prevents carburetor icing
- increases operational reliability

SIZE	QTY/CS	MFG #	PART #
0.15-Liter	6	20108	746087



MOTORBIKE GASOLINE STABILIZER (FUEL)

Preserves fuel against premature aging and oxidation during long term storage. Prevents corrosion in fuel system and increases operational reliability of 2- and 4-stroke engines in motor scooters, ATVs, snowmobiles etc. during long-term storage.

- has a lasting effect
- increases operational reliability
- simple to use
- ideal with catalytic converters
- cost-effective due to exact dosage
- protects fuel against oxidation and aging

SIZE	QTY/CS	MFG #	PART #
0.25-Liter	6	20052	746085



MOTORBIKE RADIATOR CLEANER (COOLANT)

Removes deposits from cooling systems in all motor vehicles. It removes scale, grease, sludge and other deposits to allow restored performance and proper cooling.

- removes oil and grease-based contaminants
- chemical conversion of lime
- compatible with antifreeze
- neutral behavior on rubber and plastics
- neutralizes acids
- disperses sludge

SIZE	QTY/CS	MFG #	PART #
0.15-Liter	6	20166	746084



MOTORBIKE ENGINE FLUSH (OIL)

A highly effective formulation for quick and safe removal of deposits from engines before an oil change. A clean engine will provide less wear, lower emissions and improved performance while preventing premature oil degradation.

- cleaning and care
- simple to use
- does not attack common sealing materials
- restores the engine to its original performance
- ideal with catalytic converters
- long engine service life
- highly economical

SIZE	QTY/CS	MFG #	PART #
0.08-Liter	24	20196	746080
0.25-Liter	6	20050	746083



MOTORBIKE SPEED SHOOTER (FUEL)

A unique, state-of-the-art combination of acceleration-enhancing, cleaning, dispersing and material-protecting additives. Easy engine start, smoother running and better throttle response are the effects.

- good corrosion protection
- residue-free combustion
- guarantees optimum combustion
- improves acceleration
- removes deposits from entire fuel system
- highly economical
- prevents carburetor icing
- higher performance gain

SIZE	QTY/CS	MFG #	PART #
0.8-Liter	24	20140	746082



MOTORBIKE MOS2 SHOOTER (OIL)

Provides immediate friction and wear reduction. An extremely protective and pressure-resistant boundary layer will form on all wear surfaces and provide cold-start lubrication to prevent damage caused by lack of oil. The result is longer engine life, improved efficiency and less noise

- increases smooth operation
- ideal with catalytic converters
- smooth engine running
- minimizes friction
- miscible with all commercially available gear oils
- miscible with all commercially available motor oils
- reduces oil and fuel consumption
- prevents operational malfunctions
- reduces wear

SIZE	QTY/CS	MFG #	PART #
0.2-Liter	24	20296	746081



MULTIPURPOSE GREASE

High performance Multipurpose Grease for use in a wide range of applications in motor vehicles and general machine lubrication. Carefully selected ingredients offer good corrosion protection, ensures long-term lubrication in damp and dusty environments. Resists cold and hot water washout.

- excellent stability to liquefying
- friction and wear reducing
- good corrosion protection
- highest load-carrying capacity
- especially resistant to cold and hot water
- outstanding slip properties
- optimum stability to aging

SIZE	QTY/CS	MFG #	PART #
0.40-kg	12	20246	746091



LM 50 LITHO HT

High performance grease used in a wide range of applications in motor vehicles. Specifically recommended for fast spinning bearings with high load such as wheel bearings. Provides excellent wear protection and high-pressure absorbance capacity

- high capacity
- wide operating temperature range
- highest load-carrying capacity
- optimum stability to aging
- friction and wear reducing
- good corrosion protection
- universal application

SIZE	QTY/CS	MFG #	PART #
0.40-kg	12	20248	746092



LONG-LIFE GREASE + MOS2

A high-performance grease suitable for a wide range of applications in all motor vehicles and for general machine lubrication. Thanks to added MoS2 it provides excellent protection during extreme loads and high heat while providing excellent dry-run properties. Designed as a CV-joint lubricant it's also recommended for high-load bearings and joints

- optimizes engine performance
- prevents corrosion in the fuel system
- reduces residue
- environmentally friendly
- increases operational reliability
- for carburetor and fuel-injection engines
- highly economical
- reduces the risk of knocking combustion
- normalizes fuel consumption and exhaust emissions

SIZE	QTY/CS	MFG #	PART #
0.10-kg	12	2003	746088



LM 508 ANTI-SEIZE COMPOUND

A release agent, specifically designed for high temperature applications on threaded connections and parting surfaces which are exposed to high temperatures, high pressures and corrosive effects in turbines, compressor equipment, exhaust systems, spark plug threads etc.

- outstanding thermal resistance
- resistant to acceleration forces
- outstandingly adherent
- long-term corrosion protection
- lubricant and release effect
- prevents brake noise
- universal application
- protects from welding and seizing

SIZE	QTY/CS	MFG #	PART #
0.10-kg	12	2012	746089

LM 48 INSTALLATION PASTE



A unique, state-of-the-art combination of acceleration-enhancing, cleaning, dispersing and is used for assembly of engines, gearboxes, industrial machinery or for press fitting etc. Very adherent on polished surfaces. Use on engine bearings, piston skirts, camshaft lobes etc. Prevents dry-run damage at start-up.

- outstanding emergency-running properties
- outstandingly adherent
- high capacity
- high wear resistance
- good corrosion protection
- low coefficient of friction
- easy to use
- highly economical

SIZE	QTY/CS	MFG #	PART #
0.5-kg	12	20216	746090

CLEANER AND POLISH



MOTORBIKE VISOR CLEANER

Preserves and cleans helmets, visors and protective goggles. Active anti-misting agent for common glass and plastic surfaces. The product has a long-term effect. Removes dirt, insects, oil and silicone layers. For a clear view and increased safety.

Used especially for cleaning, care and anti-misting for common glass and plastic surfaces.

SIZE	QTY/CS	MFG #	PART #
100ml	12	20160	746299

CHAIN CARE



LIQUI MOLY MOTORBIKE CHAIN LUBE .40 LITER

Fully synthetic, adherent and waterproof chain spray with a wide application range. Suitable for both on- and off-road driving. Offers an outstanding creep and lubricating effect, reduces chain elongation, and extends the chain's service life. With complex ester technology.

For initial and maintenance lubrication of power-transmission chains with and without O-rings and X-rings.

SIZE	QTY/CS	MFG #	PART #
400ml	12	20350	746296

FILTER CARE



MOTORBIKE FOAM FILTER CLEANER

Water-miscible cleaning concentrate specially formulated for air filters. Excellently dissolves dust, dirt and grease and cleans gently, without damage to the foam pores. Has high capacity and is therefore economical to use.

For all standard foam air filters in the 2 and 4-stroke range.

SIZE	QTY/CS	MFG #	PART #
400ml	12	20218	746297



MOTORBIKE FOAM FILTER OIL

Special oil for wetting foam air filters. Thanks to the outstanding adhesive properties of the liquid, sand and dust are reliably trapped in the filter, preventing greater wear on the engine. Increases engine service life. Water-repellent effect. Does not resinify or foam. The blue color when the filter is wetted helps to ensure uniform application.

Suitable for use on all 2-stroke and 4-stroke motorbikes with air or water-cooled engines using foam air filters.

SIZE	QTY/CS	MFG #	PART #
1000ml	12	20308	746298

LUBRICANTS



DRAIN COCK DIN 61 WITH DISPOSABLE SEAL

Suitable for all LIQUI MOLY oil canisters in 20-liter containers with ventilation and DIN 61 thread. Drain cock without ventilation. Spare seals (sealing rings (4 pieces), part no. 29130).

SIZE	QTY/CS	MFG #	PART #
1 pc PE Bag	12	7924	746093



PROUDLY DISTRIBUTED BY

**AUTOMATIC
DISTRIBUTORS**



ELECTRICAL CONTACT GREASE

Electrical Contact Grease is a state-of-the-art product which is characterized by exceptional mechanical stability. The very high load carrying ability, excellent resistance to water, oxidation and corrosion, and outstanding performance in a wide temperature range, make it a high performance premium grease. It contains no heavy metals or other harmful or environmentally undesirable additives, such as phosphorus, chlorine, zinc, phenols, antimony, barium or lead. Sold each.

DESC	QTY/CS	MFG#	PART #
2 oz Tube	12	11755	LB11755



HIGH-VISCOSITY 80W/90 GEAR LUBE

Ideal for modern outboard and stern drive lower units. Meets or exceeds API-MT-1 and GL-5 ratings. Will not void manufacturer's warranties. Sold each.

DESC	QTY/CS	MFG#	PART #
1 Quart	12	11552	LB11552



STORAGE FOGGING OIL

Protects internal components of 2- and 4-cycle engines from rust, corrosion or seizing during seasonal storage. Displaces moisture on all electrical motors, wet engines and equipment. Frees and loosens rusted nuts, bolts and parts in a super penetrating action. Lubricates and silences irritating squeaks. Cleans and protects metal surfaces. Sold each.

DESC	QTY/CS	MFG#	PART #
9.75 oz Can	12	11412	LB11412



V-TWIN MINERAL ENGINE OIL



High-quality mineral-based oil for V-Twin engines, offering excellent viscosity retention and anti-wear protection. Keeps engines clean and meets Harley-Davidson warranty requirements. Sold per bottle.

DESCRIPTION	QTY/CS	PART #
10w40-32 oz	12	930132
20w50-32 oz	12	930133
20w50-128 oz	4	930134
25w60-32 oz	12	930137

V-TWIN MINERAL ENGINE OIL



This mineral-based oil protects Pre-Evolution® V-Twin engines from breakdown. Its shear-stable formula meets Harley-Davidson warranty requirements. Sold per bottle.

DESCRIPTION	QTY/CS	PART #
50 WT-32 oz	12	930138
60 WT-32 oz	12	930139
70 WT-32 oz	12	930140

V-TWIN SYNTHETIC BLEND ENGINE OIL



This semi-synthetic oil for V-Twin engines reduces wear and maintains viscosity, ensuring engine cleanliness while meeting Harley-Davidson warranty requirements.

DESCRIPTION	QTY/CS	PART #
20w50-32 oz	12	930141

V-TWIN FULL SYNTHETIC ENGINE OIL



Ester-based full synthetic oil for H-D V-Twin engines, providing superior protection, reduced wear, and excellent viscosity retention. Prevents sludge buildup for smooth operation.

DESCRIPTION	QTY/CS	PART #
20w50-32 oz	12	930142

SXS FULL SYNTHETIC ENGINE OIL



Full synthetic, ester-fortified 4-stroke engine oil for side-by-side (SXS) engines, ensuring excellent viscosity stability and film thickness. Advanced additives reduce temperatures, enhance power, and extend engine life.

DESCRIPTION	QTY/CS	PART #
0w-40 Liter Bottle	12	930178

SXS SIDE-X-SIDE ENGINE OIL



High-performance 4-cycle engine oil for side-by-side vehicles that lowers temperatures, boosts power, and ensures engine cleanliness. Safe for wet clutch systems.

DESCRIPTION	QTY/CS	PART #
10w40 Liter/bot	12	930095
10w40 128 oz/bot	4	930096
5w50 Liter/bot	12	930151

530MX



Triple-ester synthetic oil boosts horsepower, torque, and clutch feel, with advanced protection and stable viscosity. Safe for wet clutches, meets API SG and JASO MA standards. Sold per bottle.

DESCRIPTION	QTY/CS	PART #
5w30 Liter Bottle	12	930037

ATV PREMIUM



ATV-specific multi-grade oil with advanced additives ensures stable viscosity, anti-scurf protection, and high performance in 4-cycle engines. Sold per bottle.

DESCRIPTION	QTY/CS	PART #
10w40 Liter Bottle	12	930025



SCOOTER 4T

Maxima Scooter 4T is formulated for modern scooters and mopeds, offering protection against stop-and-go traffic and idling. It features antiwear additives for smooth engine performance. Sold per bottle.

DESCRIPTION	QTY/CS	PART #
10w40 Liter Bottle	12	930130



SYNBLEND4

Ester-based synthetic blend protects engines, reduces wear, and stabilizes viscosity for 4-cycle motorcycles. Exceeds JASO-MA, API SG/CC. Sold per bottle.

DESCRIPTION	QTY/CS	PART #
10w40 Liter Bottle	12	930016
10w40 128 oz Bottle	4	930092
20w50 Liter Bottle	12	930020
20w50 128 oz Bottle	4	930093



EXTRA4

100% synthetic motorcycle oil with ester blend for reduced wear, lower temps, and smooth shifting. Exceeds JASO-MA, API SG/CC. For wet clutches. Sold per bottle.

DESCRIPTION	QTY/CS	PART #
5w40 Liter Bottle	12	930090
10w40 Liter Bottle	12	930014
10w40 128 oz Bottle	4	930084
10w60 Liter Bottle	12	930085
15w50 Liter Bottle	12	930015
15w50 128 oz Bottle	4	930087



PREMIUM 4

Multi-grade motorcycle oil for "Wet" clutches, ensuring viscosity stability and protection for 4-cycle engines. Features advanced anti-wear and anti-shear additives. Exceeds JASO-MA M/C 4T and API SG/CC specs. Sold per bottle.

DESCRIPTION	QTY/CS	PART #
5w30 Liter Bottle	12	930021
5w30 128 oz Bottle	4	930094
10w40 Liter Bottle	12	930017
10w40 Gallon Bottle	4	930018
20w50 Liter Bottle	12	930019
20w50 Gallon Bottle	4	930022



PRO PLUS+

Ester-fortified synthetic 4T oil for engines with wet clutches, minimizing deposits and protecting critical components. Exceeds JASO MA, API SL/SJ/SH/SG. Sold per bottle.

DESCRIPTION	QTY/CS	PART #
10w30 Liter Bottle	12	930078
10w30 128 oz Bottle	4	930079
10w40 Liter Bottle	12	930080
10w40 128 oz Bottle	4	930081
20w50 Liter Bottle	12	930082
20w50 128 oz Bottle	4	930083
10w50 Liter Bottle	12	930152
10w50 128 oz Bottle	4	930153



PREMIUM 2

Low-smoke synthetic blend with ashless additives for clean performance. Exceeds API TC, ISO-E-GD, JASO-FC standards. For 2-cycle engines, mix 20:1 to 60:1. Sold per bottle.

DESCRIPTION	QTY/CS	PART #
Liter Bottle	12	930004
128 oz Bottle	4	930106



MLT TRANSMISSION FLUID

For 2- & 4-cycle transmissions with wet clutches and brakes. Advanced additives extend clutch life and reduce slippage. Sold per bottle.

DESCRIPTION	QTY/CS	PART #
75 WT Liter Bottle	12	930028
80 WT Liter Bottle	12	930027
85 WT Liter Bottle	12	930026



MARINE PRO

Petroleum-based 2-cycle oil for personal watercraft and outboards. Exceeds NMMA TC-W3 and API TC standards, offering rust, corrosion, and anti-wear protection. Suitable for premix or oil injection. Sold per bottle.

DESCRIPTION	QTY/CS	PART #
128 oz Bottle	4	930012



CASTOR 927



Unique castor-synthetic blend with additives for reduced carbon, rust protection, and high-temp lubrication. Ideal for premix; biodegradable. Sold per bottle.

DESCRIPTION	QTY/CS	PART #
16 oz Bottle	12	930007
Liter Bottle	12	930006
64 oz Bottle	6	930008

FORMULA K2



100% synthetic 2-cycle oil with advanced esters for top protection, reduced wear, and minimal carbon buildup. Premix only. Sold per bottle.

DESCRIPTION	QTY/CS	PART #
16 oz Bottle	12	930103
Liter Bottle	12	930005
64 oz Bottle	6	930104

TUNDRA SNOWMOBILE



Tundra 2-cycle oil, low-smoke, anti-wear formula for snowmobile engines. API-TC, JASO-FC, ISO-E-GD. For oil injection or premix. Sold per bottle.

DESCRIPTION	QTY/CS	PART #
128 oz Bottle	4	930010

PWC MARINE



PWC-specific multi-grade oil with advanced additives for stability and performance. Viscosity stable, reduces wear and friction, and exceeds FC-W specifications. Designed for wet clutches. Sold per bottle.

DESCRIPTION	QTY/CS	PART #
10w40 Liter Bottle	12	930013

SUPER-M



Super-M is a high-performance, clean-burning, smokeless 2-cycle racing oil with advanced anti-scoff protection. Environmentally friendly. Sold per bottle.

DESCRIPTION	QTY/CS	PART #
16 oz Bottle	12	930001
Liter Bottle	12	930000
64 oz Bottle	6	930002



SXS PREMIUM TRANSMISSION

SXS TRANS transmission oil for side-by-side vehicles reduces drag, extends gear life, and protects against wear and rust. For wet rear brakes and clutch systems. Sold per bottle.

DESCRIPTION	QTY/CS	PART #
80 wt. Liter Bottle	12	930110

BREAK-IN OIL



MAXIMA PREMIUM BREAK-IN OIL provides high-zinc protection for flat tappet cams, ideal for racing engines during break-in. Sold per bottle.

DESCRIPTION	QTY/CS	PART #
10w30 Liter Bottle	12	930074

QUICK 2 MIX BOTTLE



Maxima Quick 2 Mix™ bottle allows precise gas/oil ratio mixing from 24:1 to 100:1. Compact, durable, easy to measure. Sold per bottle.

DESCRIPTION	QTY/CS	PART #
20 oz Bottle	20	930070

PREMIUM GEAR OIL 80W90



High-Shear Gear Oil: Long-lasting, for hypoid gears and separate clutch systems. Sold per bottle.

DESCRIPTION	QTY/CS	PART #
Liter Bottle	12	930029

SUPER-M INJECTOR



Super-M Injector Oil for oil injection systems or premix, meets JASO-FC, ISO-E-GD, API-TC standards. Sold per bottle.

DESCRIPTION	QTY/CS	PART #
Liter Bottle	12	930105
Gallon Bottle	4	930003



SXS PREMIUM GEAR OIL

SXS GEAR is a hypoid differential oil for side-by-side vehicles, offering top wear and shock protection for off-road use. Exceeds API GL-5 specs. Sold per bottle.

DESCRIPTION	QTY/CS	PART #
80w90 Liter Bottle	12	930111



MPPL PENETRANT LUBE

Penetrating, moisture-displacing spray with rust protection. Safe for plastic and painted surfaces. Sold each.

DESCRIPTION	QTY/CS	PART #
14.5 oz Aerosol Can	12	930054



ATV/SNOWMOBILE CHAINCASE LUBE

100% synthetic chain case oil for snowmobiles and ATVs, with low-temperature flow and rust protection. For enclosed chain cases. Sold per bottle.

DESCRIPTION	QTY/CS	PART #
16 oz Bottle	12	930048



SYNTHETIC RACING SHOCK FLUID

Ester-based synthetic shock fluid for extreme temperatures and racing demands. Sold per bottle.

DESCRIPTION	QTY/CS	PART #
Light 3wt. 32 oz Bottle	12	930120



SYNTHETIC GEAR OIL 75W90

Maxima Synthetic Gear Oil: For motorcycle shaft drives, enhances shifting, GL4/GL5 compatible. Sold per bottle.

DESCRIPTION	QTY/CS	PART #
Liter Bottle	12	930030



HITEST OCTANE BOOSTER

Increases octane and prevents engine knocking. Mixes with gasoline or alcohol, safe for 2- and 4-cycle engines. Sold per bottle.

DESCRIPTION	QTY/CS	PART #
16 oz Bottle	12	930064



RACING FORK FLUID

Zero Drag Fork Fluid: Smooth fork action with anti-stiction, anti-foam, and rust protection. Sold per bottle.

DESCRIPTION	QTY/CS	PART #
5 WT Liter Bottle	12	930034
7 WT Liter Bottle	12	930035
10 WT Liter Bottle	12	930036
15 WT Liter Bottle	12	930113



COOL-AIDE READY-TO-USE

Ready-to-use or concentrated coolant for racing, reduces engine temperature, biodegradable. No freeze protection. Sold per bottle.

DESCRIPTION	QTY/CS	PART #
64 oz Ready to Use	6	930127



FORK OIL

Reduces friction, wear, and stiction, with stable viscosity for smooth fork action. For all suspension types. Sold per bottle.

DESCRIPTION	QTY/CS	PART #
5 WT 16 oz Bottle	12	930039
10 WT 16 oz Bottle	12	930040
10 WT Liter Bottle	12	930043
15 WT 16 oz Bottle	12	930041
15 WT Liter Bottle	12	930044
20 WT 16 oz Bottle	12	930042



V-TWIN FORK OIL

Premium oil with Lubricinol for smooth operation, reduces stiction, and protects against corrosion. Available in 5WT, 10WT, 20WT. Sold per bottle.

DESCRIPTION	QTY/CS	PART #
10 WT-32 oz	12	930148
20 WT-32 oz	12	930149



MAXIMA ASSEMBLY LUBE

Anti-wear, rust-protecting lube for initial startup; non-foaming. Mixes with all oils. Sold per bottle.

DESCRIPTION	QTY/CS	PART #
4 oz Bottle	-	930150



ASSEMBLY GREASE

Specialty high performance assembly grease that excels in a multitude of heavy duty and light duty applications, from building engines to building chassis.

DESCRIPTION	QTY/CS	PART #
16 oz Jar	12	930268



CLEANUP

Emulsion cleaner for chains, safe on rubber o-rings; spray, rinse with water. Not for painted surfaces or clear plastic. Sold each.

DESCRIPTION	QTY/CS	PART #
15.5 oz Aerosol Can	12	930058



SPEED WAX

All-in-one detailer for painted surfaces, chrome, and plastic; easy to apply/remove, provides high shine. Sold each.

DESCRIPTION	QTY/CS	PART #
15.5 oz Aerosol Can	12	930077



SUSPENSION CLEAN

Fast-drying cleaner for internal/external suspension, safe for o-rings, moisture-resistant, residue-free. Sold each.

DESCRIPTION	QTY/CS	PART #
13 oz Aerosol Can	12	930053



WATERPROOF GREASE

Multi-purpose, high-temperature grease for extreme conditions, clings to metal, resists water, ideal for bearings/boat trailers. Sold per jar.

DESCRIPTION	QTY/CS	PART #
16 oz Jar	12	930057



RACING SHOCK FLUID

High-performance petroleum shock fluid with a 350+ viscosity index, low pour point, and reduced friction, suitable for steel or aluminum suspension. Sold per bottle.

DESCRIPTION	QTY/CS	PART #
Light Liter Bottle	12	930032
Medium Liter Bottle	12	930033
Heavy 32 oz Bottle	12	930122



FFT FOAM FILTER TREATMENT

Synthetic polymer filter oil that boosts airflow, resists water/gas washout, and retains contaminants. Sold per bottle.

DESCRIPTION	QTY/CS	PART #
16 oz Bottle	12	930045
Liter Bottle	12	930046



ELECTRICAL CONTACT CLEANER

Removes grease/oil quickly, safe on plastics, dries residue-free, VOC compliant. Ideal for engines, throttle bodies, etc. Sold each.

DESCRIPTION	QTY/CS	PART #
13 oz Aerosol Can	12	930051



BIO WASH

Biodegradable cleaner for delicate surfaces; safe on paint, plastic, chrome, aluminum; VOC compliant. Sold per bottle.

DESCRIPTION	QTY/CS	PART #
32 oz Bottle	12	930071



AIR FILTER CLEANER SPRAY

Effective spray cleaner for foam/fabric filters; washes out with water, no CFCs. Not for clear plastic. Sold each.

DESCRIPTION	QTY/CS	PART #
15.5 oz Aerosol Can	12	930052



FAB-1

Synthetic formula for foam/fabric filters; highly tacky, water-resistant, prevents washout, blocks dirt. Sold each.

DESCRIPTION	QTY/CS	PART #
13 oz Aerosol Can	12	930047



AIR FILTER CARE COMBO KIT

Includes Air Filter Cleaner (15.5 oz) and FAB-1 Spray (13 oz); maximizes airflow, cleans/oils foam and fabric filters. Sold each.

DESCRIPTION	QTY/CS	PART #
2 Pack Aerosol Cans	6	930125



CHAIN WAX

waxy coating for long-term protection, anti-fling, reduces chain wear. Sold each.

DESCRIPTION	QTY/CS	PART #
5.5 oz Aerosol Can	20	930049
13.5 oz Aerosol Can	12	930050



CHAIN GUARD

Synthetic, waterproof lubricant for o-ring and standard chains, anti-fling, rust-resistant. Sold each.

DESCRIPTION	QTY/CS	PART #
6 oz Aerosol Can	20	930055
14 oz Aerosol Can	12	930056



CHAIN WAX CHAIN CARE KIT

Includes Clean-Up degreaser, MPPL spray lubricant, Chain Wax; extends chain/sprocket life. For on and off-road use.

DESCRIPTION	QTY/CS	PART #
3 Pk Aerosol Cans	4	930123

3 PACK CONTAINS: - Clean-Up 15.5 oz - MPPL 14.5 oz - Chain Wax 13.5 oz



CHAIN WAX CHAIN CARE KIT FEATURING SYNTHETIC CHAIN GUARD

Includes Clean-Up degreaser, MPPL spray lubricant, Chain Wax; extends chain/sprocket life. For on and off-road use.

DESCRIPTION	QTY/CS	PART #
3 Pk Aerosol Cans	4	930124

3 PACK CONTAINS: - Clean-Up 15.5 oz - MPPL 14.5 oz - Chain Guard 14 oz



DOT 4 RACING BRAKE FLUID

Zero-fade formula for extreme conditions, prevents vaporization, oxidation-resistant. Dry BP 622°F, Wet BP 399°F.

DESCRIPTION	QTY/CS	PART #
MAXIMA Dot 4 Racing Brake Fluid 16.9 oz	24	930221



SC1 DETAILER

High-gloss finish for Powersports plastics, fiberglass; resists water, repels mud/dirt. Sold each.

DESCRIPTION	QTY/CS	PART #
4 oz. Can	12	930261
12 oz Aerosol Can	12	930062



DOT 4 BRAKE FLUID

High-performance fluid with anti-vapor lock, resists corrosion, compatible with multiple rubbers. Dry BP 469°F, Wet BP 318°F.

DESCRIPTION	QTY/CS	PART #
MAXIMA Dot 4 Brake Fluid 16.9 oz	24	930220



DOT 5 BRAKE FLUID

Silicone-based, ideal for finishes protection, anti-vapor lock, corrosion-resistant. Dry BP 572°F, Wet BP 429°F.

DESCRIPTION	QTY/CS	PART #
MAXIMA DOT 5 BRAKE FLUID 16.9OZ	24	930222



DOT 5.1 BRAKE FLUID

Multi-spec fluid, anti-vapor lock, corrosion-resistant, compatible with various rubbers. Dry BP 516°F, Wet BP 369°F.

DESCRIPTION	QTY/CS	PART #
MAXIMA DOT 5.1 BRAKE FLUID 16.9OZ	24	930223



SCOOTER GEAR OIL

Mineral-based gear oil specifically formulated for use in 2-stroke or 4-stroke scooters and mopeds.

DESCRIPTION	QTY/CS	PART #
180ml / 6.1oz	-	930186



BIOFOAM

Biodegradable, ultra-stable foam stays in place and works quickly to penetrate dirt, oil and other debris. Fast acting solution lifts debris from the surface, allowing easy removal with water. Proprietary formula promotes better foam adhesion to the surface, allowing for a more effective wash that saves time and money.

DESCRIPTION	QTY/CS	PART #
Biofoam	-	930428



FOAM CANNON

Foam cannon sprayer attaches directly to most pressure washer trigger sprayers via 1/4" quick connect allowing for application of Maxima Racing Oils Bio Foam (or desired solution).

DESCRIPTION	QTY/CS	PART #
Foam Cannon	-	930427



55 GALLON SERVICE DRUM

High-quality petroleum-based, with advanced additives for 4-cycle engines, wet clutches, and integrated transmissions. Suitable for motorcycles, ATVs, and UTVs. API SL and JASO MA2.

DESCRIPTION	QTY/CS	PART #
10w 30	-	930224
10w 40	-	930225
20w 50	-	930226



FULL SYN TECH SERVICE DRUM

Mineral based 4-stroke engine oil designed to ensure optimum protection, peak performance and positive clutch feel.

DESCRIPTION	QTY/CS	PART #
5W-50	-	930230



5 GALLON PAIL PUMP

The economical plastic pump fits on all Maxima 5-gallon pails and 55-gallon drums.

DESCRIPTION	QTY/CS	PART #
Plastic Pump	-	930069



SC1 AIR FRESHENER

Enjoy the scent of Maxima's SC1 with this convenient hanging air freshener. Perfect for your car, garage or gear bag.

DESCRIPTION	QTY/CS	PART #
Air Freshener	-	930259



COOLANOL

Ready-to-use antifreeze blend with anti-rust, anti-foam agents for motorcycles and ATVs, protects from -34°F to 265°F. Biodegradable. Sold per bottle.

DESCRIPTION	QTY/CS	PART #
64 oz Bottle	6	930059



MILWAUKEE-EIGHT SYNTHETIC 20W-50 ('17-CURRENT MILWAUKEE-EIGHT ENG)

V-Twin Oil Change Kits are designed to ease the oil change process in your H-D® motorcycle. Each kit comes with all necessary products to complete a full oil change.

DESCRIPTION	QTY/CS	PART #
Full Kit 20W-50 Black	-	930234
Full Kit 20W-50 Chrome	-	930235
Quick Kit 20W-50 Black	-	930236
Quick Kit 20W-50 Chrome	-	930237



SPORTSTER SYNTHETIC 20W-50 ('86-CURRENT SPORTSTER ENG)

V-Twin Oil Change Kits are designed to ease the oil change process in your H-D® motorcycle. Each kit comes with all necessary products to complete a full oil change.

DESCRIPTION	QTY/CS	PART #
Full Kit 1986-PRE-SENT20W-50 Black	-	930189
Full Kit 1986-PRE-SENT20W-50 Chrome	-	930190



TWIN CAM SYNTHETIC 20W-50 ('99 - CURRENT TWIN CAM ENG)

V-Twin Oil Change Kits are designed to ease the oil change process in your H-D® motorcycle. Each kit comes with all necessary products to complete a full oil change.

DESCRIPTION	QTY/CS	PART #
Full Kit 1999-PRESENT 20W-50 Black	-	930187
Full Kit 1999-PRESENT 20W-50 Chrome	-	930188
Quick Kit 1999-PRESENT 20W-50 Black	-	930193
Quick Kit 1999-PRESENT 20W-50 Chrome	-	930194



EVOLUTION MINERAL 20W-50 ('84-'99 EVOLUTION ENG)

V-Twin Oil Change Kits are designed to ease the oil change process in your H-D® motorcycle. Each kit comes with all necessary products to complete a full oil change. Exceeds OEM specifications.

DESCRIPTION	QTY/CS	PART #
Black	-	930191
Chrome	-	930192



SPORTSTER MINERAL 20W-50 ('84-'99 EVOLUTION ENG) ('99-CURRENT SPORTSTER ENG)

V-Twin Oil Change Kits are designed to ease the oil change process in your H-D® motorcycle. Each kit comes with all necessary products to complete a full oil change.

DESCRIPTION	QTY/CS	PART #
Quick Kit 20W-50 Black	-	930195
Quick Kit 20W-50 Chrome	-	930196



SXS QUICK CHANGE KIT SYNTHETIC W/ BLACK FILTER

Kit includes all products necessary to complete an oil change on your Polaris Side-by-Side. Engine oil, ProFilter oil filter and a drain plug crush washer.

DESCRIPTION	QTY/CS	PART #
5W50	-	930238
10W50	-	930239



EVOLUTION MINERAL 20W-50 ('84-'99 EVOLUTION ENG)

V-Twin Oil Change Kits are designed to ease the oil change process in your H-D® motorcycle. Each kit comes with all necessary products to complete a full oil change.

DESCRIPTION	QTY/CS	PART #
Full Kit 1986-PRE-SENT20W-50 Black	-	930189
Full Kit 1986-PRE-SENT20W-50 Chrome	-	930190



SXS - CAN-AM MAVERICK X3 QUICK CHANGE KIT

Can-Am Maverick X3 Quick Change Kit includes all products necessary to complete an oil change on your Can-Am Maverick X3 Side-by-Side. 4 liters of Maxima SXS Full Synthetic 5W-40 or 10W-50 engine oil, ProFilter Premium Cartridge Oil Filter (PF-152), 2 drain plug crush washers and oil filter cover O-ring.

DESCRIPTION	QTY/CS	PART #
5W-40	-	930254
10W-50	-	930253



SXS - POLARIS TURBO QUICK CHANGE KIT

Polaris RZR Turbo Quick Change Kit includes all products necessary to complete an oil change on your Polaris RZR Turbo Side-by-Side.

DESCRIPTION	QTY/CS	PART #
5W-50	-	930263
10W-50	-	930264



SXS - HONDA TALON QUICK CHANGE KIT

Honda Talon Quick Change Kit includes all products necessary to complete an oil change on your Honda Talon Side-by-Side. 7 liters of Maxima SXS Premium 10W-40 engine oil, ProFilter Premium Cartridge Oil Filter (PF-114), 2 drain plug crush washers and oil filter cover O-ring.

DESCRIPTION	QTY/CS	PART #
10W-40	-	930430



SXS - KAWASAKI TERYX QUICK CHANGE KIT

Kawasaki Teryx Quick Change Kit includes all products necessary to complete an oil change on your Kawasaki Teryx Side-by-Side.

DESCRIPTION	QTY/CS	PART #
5W-40	-	930431



RACING FORK FLUID

Mineral based racing fork oil designed for all high performance cartridge and standard-type forks. Shear-stable, high viscosity index formulation maintains film strength and utilizes industry-leading anti-wear chemistry to reduce wear.

DESCRIPTION	QTY/CS	PART #
5WT 5 Gallons/19 Liters	-	930258



SCOOTER PRO

Semi-synthetic, ester-based 2-stroke engine oil designed to ensure optimum protection and peak performance for scooters and mopeds.

DESCRIPTION	QTY/CS	PART #
33.8oz	-	930182



V-TWIN HEAVY DUTY TRANSMISSION/GEAR OIL

Maxima V-Twin Heavy-Duty Transmission & Gear Oil is a high-quality, mineral based motorcycle gear oil. Recommended for use in 4-, 5- and 6-speed high performance gear boxes.

DESCRIPTION	QTY/CS	PART #
85W140 32oz	-	930143
80W90 32oz	-	930144



V-TWIN SPORTSTER GEAR/CHAIN CASE OIL

Mineral-based motorcycle gear oil formulated specifically for use in high performance V-Twin Sportster transmissions and primary chain cases.

DESCRIPTION	QTY/CS	PART #
32oz	-	930145



V-TWIN PRIMARY OIL

Mineral-based motorcycle gear oil formulated specifically for use in high performance V-Twin Sportster transmissions and primary chain cases.

DESCRIPTION	QTY/CS	PART #
32oz	-	930146



V-TWIN SYNTHETIC PRIMARY FLUID

Full synthetic, ester-based motorcycle gear oil formulated specifically for use in high performance V-Twin transmissions and primary chain cases.

DESCRIPTION	QTY/CS	PART #
32oz	-	930154



PREMIUM

Mineral based 4-stroke engine oil designed to ensure optimum protection, peak performance and positive clutch feel.

DESCRIPTION	QTY/CS	PART #
10W30 33.8oz	-	930180
10W30 128oz	-	930181



SNOW 4T

Full synthetic, ester-fortified 4-stroke engine oil specifically formulated for snowmobiles and work/utility machines operating in cold climate extremes.

DESCRIPTION	QTY/CS	PART #
0W-40	-	930260



ATV FULL SYN

Full synthetic ATV engine oil formulated for sport and utility applications. Provides superior protection, oxidative stability, and shear resistance. Reduces engine temperature, increases power, and maintains viscosity with ester-fortified, surface-active chemistry.

DESCRIPTION	QTY/CS	PART #
10W-40	-	930433
5W-50	-	930434



SXS DRIVE

Kit includes all products necessary to complete an oil change on your Polaris Side-by-Side. Engine oil, ProFilter oil filter and a drain plug crush washer.

DESCRIPTION	QTY/CS	PART #
80WT 16oz	-	930240
80WT 55 Gal	-	930242



EXTRA 4

The finest 4-cycle motorcycle specific oil available on the market today by using today's most advanced additive systems and high-performance synthetic ester based stocks

DESCRIPTION	QTY/CS	PART #
0W-10	-	930088



SXS ENGINE

Ester-fortified, 4-stroke engine oil formulated specifically for SXS engines.

DESCRIPTION	QTY/CS	PART #
5W-40	-	930246
10W-50	-	930252



FORK OIL STANDARD HYDRAULIC

Mineral based fork oil designed for cartridge and standard-type forks. Shear stable, high viscosity index formulation maintains film strength and reduces wear.

DESCRIPTION	QTY/CS	PART #
5WT 1L	-	930115
20WT 1L	-	930119



SXS GEAR

Formulated specifically for use in modern side-by-side vehicles. Exceeds API GL-5 specifications.

DESCRIPTION	QTY/CS	PART #
75W-140 1 Liter	-	930249
75W-90 1 Liter	-	930425



SYNTHETIC GEAR OIL

Semi-synthetic based 4-stroke engine oil specifically formulated for Personal Watercraft, Outboards, Inboards and Stern Drives.

DESCRIPTION	QTY/CS	PART #
75W-140 1 Liter	-	930424



MARINE 4T SYN BLEND

Semi-synthetic based 4-stroke engine oil specifically formulated for Personal Watercraft, Outboards, Inboards and Stern Drives.

DESCRIPTION	QTY/CS	PART #
10W-40 4 Liters	-	930273



COOL-AIDE CONCENTRATE

Ready-to-use or concentrated coolant for racing, reduces engine temperature, biodegradable. No freeze protection. Sold per bottle.

DESCRIPTION	QTY/CS	PART #
16 oz Concentrate	12	930060



GRIP GLUE AND MULTIPURPOSE ADHESIVE



Motion Pro Grip Glue delivers pro-level performance with a strong, flexible, waterproof bond. Easy to apply and remove, it sets in 15 minutes, works with grip heaters, and outperforms rubber cement and silicones. Bonds to metal, plastic, rubber, and more. 20g tube for multiple uses.

DESCRIPTION	Man Item #	Part #
Grip Glue	15-0003	682147

CABLE LUBE



Motion Pro Cable Lube combines Redline synthetic lubricant and rust inhibitors for ultra-smooth cable operation and extended cable life. Works in all weather conditions. For best results, use with Cable Luber V3.

DESCRIPTION	Man Item #	Part #
Cable Lube	15-0002	144307

CABLE LUBE, CASE OF 6



Motion Pro Cable Lube, formulated with Redline synthetic lubricant and rust inhibitors, ensures smooth cable operation in all conditions and extends cable life. For optimal use, pair with Cable Luber V3 (P/N 08-0609).

DESCRIPTION	Man Item #	Part #
Cable Lube Case of 6	15-0001	682243

FUEL INJECTOR CLEANER



Designed for use with all Motion Pro Fuel Injector Cleaner Kits, this formula safely removes deposits from fuel injectors, improving mileage and reducing emissions. Safe for all gasoline engines and won't harm O-rings or injector parts.

DESCRIPTION	Man Item #	Part #
Fuel Injector Cleaner	15-0004	682202

FUEL INJECTOR, CASE OF 6



Motion Pro Cable Lube, formulated with Redline synthetic lubricant and rust inhibitors, ensures smooth cable operation in all conditions and extends cable life. For optimal use, pair with Cable Luber V3 (P/N 08-0609).

DESCRIPTION	Man Item #	Part #
Fuel Injector Case of 6	15-0005	682203



2 STROKE OIL



FORMULA 2T

- Synthetic blend.
- Suitability for use with catalytic converters checked.
- Minimal combustion residues.
- Especially low smoke.
- For pre-mix and separate lubrication.

SIZE	QTY/CS	MFG #	PART #
1-L	10	308244	746180



POWER SYNT 2T

- Fully synthetic high-performance engine oil for 2-stroke supersport motorcycles.
- This lubricant offers optimum performance and maximum protection as well as extremely clean combustion.
- JASO FD, API TC, ISO-L-EGD.

SIZE	QTY/CS	MFG #	PART #
1-L	10	308248	746216



CROSS POWER 2T

- Fully synthetic.
- Especially formulated for Off-Road use.
- Racing quality.
- Reduces combustion residues.
- Low-smoke formula, for pre-mix and separate lubrication.
- JASO FD, API TC, ISO-L-EGD.

SIZE	QTY/CS	MFG #	PART #
1-L	10	308092	746164
4-L	4	303359	746167
20-L	1	309642	746165
60-L	1	303385	746166



SCOOTER FORZA 2T

- Fully Synthetic.
- Reduces combustion residues.
- Optimum cold starting characteristics.
- Ideal for stop-and-go traffic.
- Catalytic converter tested.
- JASO FD, API TC, ISO-L-EGD.

SIZE	QTY/CS	MFG #	PART #
1-L	10	308266	746269



SCOOTER 2T

- Synthetic-blend.
- Low-smoke formula.
- Reduces combustion residues.
- Optimum cold starting characteristics.
- Ideal for stop-and-go traffic.
- Catalytic converter tested.
- API TC, ISO-L-EGC, JASO FD

SIZE	QTY/CS	MFG #	PART #
1-L	10	308263	746265



OCEAN FS 2T BIO

- Quickly biodegradable, fully synthetic two-stroke motor oil.
- Specially developed for petrol engines in the marine sector.
- The high-performance additives combined with synthetic base oils guarantee perfect lubrication – even under difficult operating conditions.

SIZE	QTY/CS	MFG #	PART #
1-L	12	301530	746212



TOP SPEED 4T SAE 5W/40 MA2

- Synthetic performance.
- Excellent wear protection.
- Particularly good thermal and shear stability.
- Reduces oil consumption.
- Catalytic converter tested.

SIZE	QTY/CS	MFG #	PART #
1-L	10	308272	746283
20-L	1	305595	746284



TOP SPEED 4T SAE 10W/30 MA2

- Synthetic performance.
- Excellent wear protection.
- Particularly good thermal and shear stability.
- Reduces oil consumption.
- JASO MA2; API SL, SM, SN

SIZE	QTY/CS	MFG #	PART #
1-L	10	308270	746273
20-L	1	305591	746274



TOP SPEED 4T SAE 10W/40 MA2

- Top Speed 10W40 is a fully synthetic engine oil is designed for use in 4-stroke motorcycle engines.
- JASO MA2; API SL, SM, SN

SIZE	QTY/CS	MFG #	PART #
1-L	10	308271	746277
4-L	4	304973	746276
20-L	1	305592	746281
200-L	1	304961	746275



TOP SPEED 4T SAE 15W/50 MA2

- Synthetic performance.
- Excellent wear protection.
- Particularly good thermal and shear stability.
- Reduces oil consumption
- JASO MA2; API SL, SM, SN.

SIZE	QTY/CS	MFG #	PART #
1-L	10	308096	746280
4-L	4	304975	746279
20-L	1	305594	746282
200-L	1	304980	746278



POWER SYNT 4T SAE 5W/40

- Fully synthetic.
- Serious power delivery.
- Racing quality.
- Optimum wear protection.
- Extremely good thermal and shear stability.
- Catalytic converter tested.
- Ideal for wet multi-disc clutches.

SIZE	QTY/CS	MFG #	PART #
1-L	10	308093	746227
4-L	4	305658	746223
20-L	1	305655	746228
200-L	1	305652	746226



POWER SYNT 4T SAE 10W/50

- Fully synthetic high-performance 4-stroke engine oil, specially developed for demanding use in hyper-sport motorcycles with powerful engines.
- These lubrications provide engines, gearboxes and clutches with optimum protection over the entire range of applications.
- JASO MA2 approval guarantees the fault-free functioning of wet multi-disc clutches.

SIZE	QTY/CS	MFG #	PART #
1-L	10	308249	746219
4-L	4	305664	746218
20-L	1	305661	746224
200-L	1	305660	746217

POWER SYNT 4T SAE 10W/60



- Fully synthetic high-performance 4-stroke engine oil, specially developed for demanding use in hyper sport motorcycles with powerful engines.
- These lubrications provide engines, gearboxes and clutches with optimum protection over the entire range of applications.
- JASO MA2; API SL, SM, SN

SIZE	QTY/CS	MFG #	PART #
1-L	10	308252	746220
4-L	4	306210	746222
20-L	1	306209	746225
200-L	1	306207	746221



CROSS POWER 4T SAE 5W/40

- Fully synthetic.
- Especially formulated for the toughest Off-Road use.
- Racing quality.
- Extremely high thermal and shear stability.
- Catalytic converter tested.

SIZE	QTY/CS	MFG #	PART #
1-L	10	308243	746175
4-L	4	305678	746177
20-L	1	305677	746176

CROSS POWER 4T SAE 10W/60



- Fully synthetic.
- Especially formulated for the toughest Off-Road use.
- Racing quality.
- Extremely high thermal and shear stability.
- Catalytic converter tested.
- JASO MA2; API SL, SM, SN

SIZE	QTY/CS	MFG #	PART #
1-L	10	308242	746172
4-L	4	306217	746173
20-L	1	306216	746174



CROSS POWER 4T SAE 10W/50

- Fully synthetic.
- Especially formulated for the toughest Off-Road use.
- Racing quality.
- Extremely high thermal and shear stability.
- Catalytic converter tested.
- JASO MA2; API SL, SM, SN.

SIZE	QTY/CS	MFG #	PART #
1-L	10	308241	746171
4-L	4	305692	746169
20-L	1	305687	746170
200-L	1	305685	746168

BOXER 4T SAE 5W/40



- Synthetic high-performance engine oil, specifically for use in water-cooled boxer engines.
- Guarantees a stable lubricating film and a constantly high oil pressure under all operating conditions and lowers the friction in the engine significantly.
- JASO MA2; API SL, SM, SN

SIZE	QTY/CS	MFG #	PART #
1-L	10	308239	746143
4-L	4	304678	746145
20-L	1	305605	746144



BOXER 4T SAE 15W/50

- Synthetic high-performance engine oil, specifically for use in 4-stroke boxer engines.
- Guarantees a stable lubricating film and a constantly high oil pressure under all operating conditions and lowers the friction in the engine significantly.
- JASO MA2; API SL, SM, SN

SIZE	QTY/CS	MFG #	PART #
1-L	10	308240	746140
4-L	4	300273	746141
20-L	1	305606	746142



RACING PRO 4T SAE 0W/40



- Fully synthetic.
- Developed and used by MOTOREX Racing Support.
- Tested and proven under the most extreme racing conditions.
- Exceptionally high shear strength and friction reduction.
- Optimal wear protection.

SIZE	QTY/CS	MFG #	PART #
1-L	10	308255	746256
4-L	4	303105	746257

RACING PRO 4T SAE 15W/50



- Fully synthetic.
- Tested and proven under the most extreme racing conditions.
- Exceptionally high shear strength and friction reduction.
- Optimal wear protection.
- Withstands the highest loads during races.

SIZE	QTY/CS	MFG #	PART #
1-L	10	308256	746258
4-L	4	303106	746259

FORMULA 4T SAE 10W/40



- High-quality synthetic blend motor oil for four-stroke motorbikes.
- This oil offers a very good level of protection for engines, gears and clutches in all fields.
- JASO MA2; API SL, SJ, SH, SG

SIZE	QTY/CS	MFG #	PART #
1-L	10	308273	746181
4-L	4	306189	746183
20-L	1	306184	746186
200-L	1	306186	746182

FORMULA 4T SAE 15W/50



- High-quality synthetic blend motor oil for four-stroke motorbikes.
- This oil offers a very good level of protection for engines, gears and clutches in all fields.
- JASO MA2; API SL, SJ, SH, SG

SIZE	QTY/CS	MFG #	PART #
1-L	10	308274	746184
4-L	4	306183	746185
20-L	1	306174	746188
200-L	1	306176	746187

ATV QUAD 4T SAE 10W/40 MA2



- Offers a good level of shear stability and a short lubrication rise time, even at low temperatures.
- Formulated for tough conditions in the four-stroke engines of ATVs.

SIZE	QTY/CS	MFG #	PART #
1-L	10	308237	746139

SCOOTER 4T SAE 10W/30 MB



- Optimal cold-starting properties.
- Very good wear protection.
- Ideal for stop-and-go traffic.

SIZE	QTY/CS	MFG #	PART #
20-L	1	306260	746266

SCOOTER 4T SAE 10W/40 MA2



- Optimal cold-starting properties.
- Very good wear protection.
- Ideal for stop-and-go traffic.
- JASO MA2; API SL, SJ, SH, SG

SIZE	QTY/CS	MFG #	PART #
1-L	10	308264	746268
20-L	1	306256	746267

SCOOTER GEAR OIL ZX SAE 80W/90



- Superior load-carrying capacity.
- Highly comfortable shifting across the entire temperature range.
- Excellent wear protection.
- Good viscosity-temperature behavior.
- Excellent oxidation stability and resistance to aging.

SIZE	QTY/CS	MFG #	PART #
130-ML	12	301158	746270

ATF DEXRON III



- Designed for KTM 50cc motorcycles 2008 and newer
- High thermal and shear stability
- Smooth clutch engagement
- Steady, controllable power

SIZE	QTY/CS	MFG #	PART #
1-L	10	308063	746137

TRIAL GEAR OIL 75W



- Trial Gear Oil 75W is a fully synthetic transmission oil designed for the specific clutch engagement requirements of trial motorcycles.
- Highly effective additive composition for optimal clutch feel and engagement.
- Smooth and consistent clutch modulation under constant, extreme loads.
- Recommended for and developed with Gas Gas trials.

SIZE	QTY/CS	MFG #	PART #
1-L	10	308875	746286
20-L	1	309799	746285

GEAR OIL HYPOID SAE 80W/90



- Gear Oil Hypoid 80W90 is a API GL-5 Gear Oil is designed to increase resistance to breakdown under high temperature and the mechanical pressure produced by hypoid gear boxes and universal joints.
- API GL-5

SIZE	QTY/CS	MFG #	PART #
1-L	10	308064	746190

MOTO GEAR OIL SAE 10W/30



Gear Oil 10W30 is a synthetic oil developed for separately lubricated gearboxes with wet-clutch.

- SAE 10W/30 (SAE 80W/85) API GL-4

SIZE	QTY/CS	MFG #	PART #
1-L	10	308237	746139

PRISMA ZX SAE 75W/90



- Guarantees optimum lubrication over a large temperature range, even under extreme conditions, both in synchronised and unsynchronised manual gearboxes in axles.
- Guarantees reliable lubrication in axle drives and end drives subject to high loads, while at the same time offering flawless functioning of manual gearbox synchronisation.
- API GL-4, GL-5

SIZE	QTY/CS	MFG #	PART #
20-L	1	306260	746266



ATF SUPER

- Synthetic automatic transmission fluid designed for ATF Dexron II applications.
- Designed for KTM 50cc motorcycles 2007 and older.
- High thermal and shear stability.
- Smooth clutch engagement.

SIZE	QTY/CS	MFG #	PART #
1-L	12	300146	746138



RACING GEAR OIL SAE 10W/40

- Synthetic (Synthetic Performance) with MC technology.
- Developed and used by MOTOREX Racing Support.
- Tested under the most extreme racing conditions.
- Optimal wear protection.
- Withstands maximum loads during races.

SIZE	QTY/CS	MFG #	PART #
1-L	12	303086	746253



GEAR OIL 10W30 API GL-4

Gear Oil 10W30 is a synthetic oil developed for separately lubricated gearboxes.

- Optimal clutch engagement without clutch slip.
- High pressure wear protection.
- Smooth gear selection.

SIZE	QTY/CS	MFG #	PART #
1L	10	301044	746189



PRISMA ZX SAE 75W/90 API GL-4+5

Prisma ZX is a synthetic gear oil designed for manual gearboxes and axle drive systems.

- Optimum lubrication over a large temperature range
- Reliable high load capacity
- Flawless function in manual gearbox synchronization
- Meets GL4 and GL5 specifications

SIZE	QTY/CS	MFG #	PART #
1L	10	301960	746229

CLEAN & CARE



MOTO QUICK CLEANER

- Beading effect.
- 360-degree spraying system (500 ml).
- Cleans plastics, visors, windscreens and varnished surfaces.
- Removes insects, dirt, dust etc.
- Particularly stubborn contamination is easily removed.
- Quick and easy cleaning – perfect for on the road too.
- Does not require additional water.

SIZE	QTY/CS	MFG #	PART #
60-ML	12	304994	746210
500-ML	12	304379	746208
5-L	4	304458	746209



MOTO CLEAN PLUS

- Lower pH value formula, has a better distribution over surfaces.
- Excellent compatibility with rubber, plastics and metal.
- Can be used overhead thanks to the MOTOREX 360° technology and special spray head.
- Ready to use but can also be used diluted to a ratio of 1:3 for cleaning small amounts of dirt.
- Pump spray bottle can be reused multiple times with the 5-litre refill.

SIZE	QTY/CS	MFG #	PART #
1-L	6	304371	746202
5-L	4	304372	746203
20-L	1	309685	746201

RACING FORK OIL 2.5W



- Improved breakaway torque (stick-slip).
- Fork oil specially developed for modern fork systems.
- Significantly improved thermal stability.
- Adaptation of the viscosity index in the maximum range.
- Improved shear stability.
- Optimum air release.

SIZE	QTY/CS	MFG #	PART #
1-L	6	306402	746241
20-L	1	309719	746242
60-L	1	305415	746243

RACING FORK OIL 5W



- Improved breakaway torque (stick-slip).
- Fork oil specially developed for modern fork systems.
- Significantly improved thermal stability.
- Adaptation of the viscosity index in the maximum range.
- Improved shear stability.
- Optimum air release.

SIZE	QTY/CS	MFG #	PART #
1-L	6	306406	746244
20-L	1	309720	746245
60-L	1	305424	746246

RACING FORK OIL 10W



- Improved breakaway torque (stick-slip).
- Fork oil specially developed for modern fork systems.
- Significantly improved thermal stability.
- Adaptation of the viscosity index in the maximum range.
- Improved shear stability.
- Optimum air release.

SIZE	QTY/CS	MFG #	PART #
1-L	6	306410	746235
20-L	1	309724	746236
60-L	1	305492	746237

RACING SHOCK OIL



- Formulated with 3D response technology for optimal low friction damping at all temperatures.
- Designed for use in modern fork systems and available in various weights for all applications.
- Fade-free formula withstands high thermal loads
- Low friction performance

SIZE	QTY/CS	MFG #	PART #
1-L	6	307516	746261
20-L	1	309769	746262
60-L	1	307513	746264

RACING FORK OIL 4W



- Improved breakaway torque (stick-slip).
- Fork oil specially developed for modern fork systems.
- Significantly improved thermal stability.
- Adaptation of the viscosity index in the maximum range.
- Improved shear stability.
- Optimum air release.

SIZE	QTY/CS	MFG #	PART #
1-L	6	306404	746250
20-L	1	309714	746251
60-L	1	305365	746252

RACING FORK OIL 7.5W



- Improved breakaway torque (stick-slip).
- Fork oil specially developed for modern fork systems.
- Significantly improved thermal stability.
- Adaptation of the viscosity index in the maximum range.
- Improved shear stability.
- Optimum air release.

SIZE	QTY/CS	MFG #	PART #
1-L	6	306408	746247
20-L	1	309721	746248
60-L	1	305456	746249

RACING FORK OIL 15W



- Improved breakaway torque (stick-slip).
- Fork oil specially developed for modern fork systems.
- Significantly improved thermal stability.
- Adaptation of the viscosity index in the maximum range.
- Improved shear stability.
- Optimum air release.

SIZE	QTY/CS	MFG #	PART #
1-L	6	306412	746238
20-L	1	309723	746239
60-L	1	305478	746240

RACING SHOCK OIL SD-1



- Shock oil that has superb damping performance.
- Optimum corrosion protection.
- Excellent air separation abilities.
- Outstanding protection against aging.
- Reliable wear protection.

SIZE	QTY/CS	MFG #	PART #
5-L	4	301994	746260



COPPER PASTE



- Application range -40 °C / +1200 °C.
- Protection against metal contacts, prevents nuts from jamming and resistant to frictional corrosion.
- Good high-pressure properties.
- Contains no graphite, molybdenum disulfide and no lead.

SIZE	QTY/CS	MFG #	PART #
100-G	18	301806	746161
850-G	12	301805	746162

FETT (GREASE) 2000



- Incredibly adhesive calcium soap grease with a high level of oxidation resistance.
- Features excellent resistance to water and outstanding pres sure-bearing capacity

SIZE	QTY/CS	MFG #	PART #
400-G	10	300787	746192
850-G	12	300746	746191

ANTI SEIZE



- Special mounting paste for metal and aluminum connections including any parts that need to be press-fit, aluminum supports in metal frames and all screw connections.

SIZE	QTY/CS	MFG #	PART #
100-G	12	309922	746134
850-G	12	309921	746135

HYDRAULIC FLUID 75



- High seal compatibility.
- Outstanding resistance to ageing.
- Not hygroscopic.
- More reliable, fast response behaviour.
- High viscosity index.
- Outstanding operating temperature range.

SIZE	QTY/CS	MFG #	PART #
250-ML	12	308841	746198
1-L	12	300230	746197

WHITE GREASE



- Lithium-based white lubricant grease especially for bicycles.
- MOTOREX WHITE GREASE has outstanding wear-reducing properties and remains malleable at cold temperatures.
- Ideal for slide bearings and crank sets.

SIZE	QTY/CS	MFG #	PART #
850-G	12	300775	746288

FETT (GREASE) 3000



- High-performance lithium complex grease based on a high-quality mineral oil.
- Suitable for challenging lubrication points.
- Specially designed for use in heavily loaded roller bearings.
- However, this high-pressure grease can also be used in smaller, fast-turning ball bearings and needle bearings.

SIZE	QTY/CS	MFG #	PART #
850-G	12	300766	746193

ETHANOL TREATMENT



- Properties reduce phase separation/ separation, optimize fuel efficiency and reduce corrosion.
- Ensures that the engine runs more easily, removes deposits in the combustion chamber, regenerates old fuel and helps to remove water from the system.

SIZE	QTY/CS	MFG #	PART #
250-ML	12	305642	746179

TYRE MOUNTING FLUID



- Special, fast-drying and economical tyre mounting fluid for effortless mounting and removal of all conventional tyres.
- Tested for tyre pressure monitoring systems. (TPMS).
- Does not leave any visible residues after mounting.

SIZE	QTY/CS	MFG #	PART #
100-ML	12	305514	746287



COOLANT M3.0 READY TO USE

- Silicate-, nitrite-, amine- borate- and phosphate-free.
- Free from 2-ethylhexanoic acid.
- Extremely effective corrosion protection for the entire cooling system.
- Excellent compatibility with all commercially available seals and cooler hoses.
- Excellent thermal conductivity.
- Extended usage duration

SIZE	QTY/CS	MFG #	PART #
1-L	10	308100	746157
20-L	1	309680	746158



COOLANT M5.0 READY TO USE

- Nitrite, amine, and borate-free.
- Does not contain 2-Ethylhexanoic acid.
- Good corrosion protection for metals and alloys in the cooling system.
- Good compatibility with commercially available elastomer and plastics high chemical stability.
- Recommended usage duration 3 years.

SIZE	QTY/CS	MFG #	PART #
1-L	10	308275	746160
20-L	1	309672	746159

AIR FILTER OIL 206



- Specially developed air filter oil for foam air filter elements with good adhesion.
- Keeps out sand, dust and water.
- Guaranteed optimal air flow.
- Very good adhesion.

SIZE	QTY/CS	MFG #	PART #
1-L	12	300052	746132



AIR FILTER CLEANER

- Cleaning agent for foam filter elements.
- Free of sol-vents, biodegradable and non-combustible.

SIZE	QTY/CS	MFG #	PART #
1-L	12	300044	746131
4-L	4	300043	746130

RACING BIO AIR FILTER OIL



- Air filter oil specially developed for off-road motorbikes and quads (ATVs) that feature a reusable foam air filter.
- This biodegradable special oil has excellent absorption capacity with regards to dust and dirt.
- Thanks to the special substances it contains, harmful foreign bodies are prevented from entering the engine – even in the toughest usage conditions.

SIZE	QTY/CS	MFG #	PART #
1-L	12	303816	746233



RACING BIO AIR FILTER CLEANER

- A cleaner in powder form specially developed for off-road motorbikes and quads (ATVs) that feature a reusable foam air filter.
- Thanks to its active substances, it also quickly dissolves the most stubborn dirt

SIZE	QTY/CS	MFG #	PART #
900-ML	12	305062	746232



RACING BRAKE FLUID



- Exceptionally high wet boiling point.
- Tested and proven under the most extreme racing conditions.
- Can be used in all ABS and ADS systems without any problems.

SIZE	QTY/CS	MFG #	PART #
500-ML	12	303274	746234

BRAKE FLUID DOT 5.1



- For hydraulic brake and clutch systems with a boiling point of at least 260 °C and an extremely high wet boiling point of at least 180 °C. Because of the low viscosity at low temperatures, particularly suitable for additional systems, such as ABS and ASR

SIZE	QTY/CS	MFG #	PART #
250-ML	12	300287	746149
1-L	12	303261	746148

YAMAHA YZ450F/FX (2020-2023) OIL CHANGE KIT



Oil changes made easy with exact fill kits for Yamaha YZ450F/FX motorcycles (previous year models).

- Exact fill - .65L of Top Speed SAE 10W40 synthetic engine oil
- JASO MA2 certified
- High quality oil filter
- OEM spec crush washer or o-ring
- Meets or exceeds all manufacturers' specifications and will not void new vehicle warranty

SIZE	QTY/CS	MFG #	PART #
.65L	10	311239	746302

HONDA CRF250R/RX OIL CHANGE KIT



Oil changes made easy with exact fill kits for Honda CRF250R/RX motorcycles.

- Exact fill - 1.08L of Top Speed SAE 10W30 synthetic engine oil
- JASO MA2 certified
- High quality oil filter
- OEM spec crush washer or o-ring
- Meets or exceeds all manufacturers' specifications and will not void new vehicle warranty

SIZE	QTY/CS	MFG #	PART #
1.08L	10	311234	746304



BRAKE FLUID DOT 4

- High-performance, premium brake fluid of outstanding quality, with a high wet boiling point and thus extreme safety reserve against vapor lock.

SIZE	QTY/CS	MFG #	PART #
250-ML	12	300280	746147
1-L	12	300296	746146

YAMAHA YZ250F/FX OIL CHANGE KIT



Oil changes made easy with exact fill kits for Yamaha YZ250F/FX motorcycles.

- Exact fill - .75L of Top Speed SAE 10W40 synthetic engine oil
- JASO MA2 certified
- High quality oil filter
- OEM spec crush washer or o-ring
- Meets or exceeds all manufacturers' specifications and will not void new vehicle warranty

SIZE	QTY/CS	MFG #	PART #
.75L	10	311237	746301

YAMAHA YZ450F/FX (2023+) OIL CHANGE KIT



Oil changes made easy with exact fill kits for Yamaha YZ450F/FX motorcycles (newer models).

- Exact fill - .96L of Top Speed SAE 10W40 synthetic engine oil
- JASO MA2 certified
- High quality oil filter
- OEM spec crush washer or o-ring
- Meets or exceeds all manufacturers' specifications and will not void new vehicle warranty

SIZE	QTY/CS	MFG #	PART #
.96L	10	311240	746303

HONDA CRF450R/RX OIL CHANGE KIT



Oil changes made easy with exact fill kits for Honda CRF450R/RX motorcycles.

- Exact fill - 1.04L of Top Speed SAE 10W30 of synthetic engine oil
- JASO MA2 certified
- High quality oil filter
- OEM spec o-ring
- Meets or exceeds all manufacturers' specifications and will not void new vehicle warranty

SIZE	QTY/CS	MFG #	PART #
1.04L	10	311236	746305

KAWASAKI KX250F/X OIL CHANGE KIT



Oil changes made easy with exact fill kits for Kawasaki KX250F/X motorcycles.

- Exact fill - .8L of Top Speed SAE 10W40 synthetic engine oil
- JASO MA2 certified
- High quality oil filter
- OEM spec crush washer or o-ring
- Meets or exceeds all manufacturers' specifications and will not void new vehicle warranty

SIZE	QTY/CS	MFG #	PART #
.8L	10	311241	746306

KAWASAKI KX450F/X OIL CHANGE KIT



Oil changes made easy with exact fill kits for Kawasaki KX450F/X motorcycles.

- Exact fill - .9L of Top Speed SAE 10W40 synthetic engine oil
- JASO MA2 certified
- High quality oil filter
- OEM spec crush washer or o-ring
- Meets or exceeds all manufacturers' specifications and will not void new vehicle warranty

SIZE	QTY/CS	MFG #	PART #
.9L	10	311242	746307

SPRAYS AND AEROSOLS

JOKER 440 SYNTHETIC SPRAY



- Fully synthetic, universal lubricating and corrosion protection spray.
- Leaves behind a highly effective protective film.
- Creeps under water, protects against corrosion, takes effect electrically and cleans and maintains metals and plastics

SIZE	QTY/CS	MFG #	PART #
500-ML	12	302317	746200

OIL SPRAY BIO



- Biodegradable oil spray for industry, the trade sector, household and hobbies.
- Lubricates all moving parts, protections against corrosion and leaves behind a colourless, thin, protective film.

SIZE	QTY/CS	MFG #	PART #
500-ML	12	302323	746213



ANTIRUST SPRAY

- Rust remover and screw releaser with outstanding creep effect.
- Quickly loosens seized-up metal parts.
- Protects against corrosion and repels moisture.
- Rust-loosening, water-repellent and lubricating.

SIZE	QTY/CS	MFG #	PART #
500-ML	12	302338	746136



POWER BRAKE CLEAN SPRAY

- Brake cleaner decreases and cleans all brake and coupling parts under high pressure without leaving any residue.
- Reliably dissolves and removes oil, grease, tar, brake fluid, dirt, etc.
- Does not attack rubber, plastic or paint.

SIZE	QTY/CS	MFG #	PART #
750-ML	12	302291	746214



MOTO PROTECT SPRAY

- Repels moisture and the fine oil film protects the treated surfaces against corrosion.
- It is also easy to apply, since the 0.5-litre spray can also be used upside down.

SIZE	QTY/CS	MFG #	PART #
500-ML	12	304250	746207



MOTO SHINE MS 1

- Special gloss spray for the perfect finish after cleaning a vehicle.
- Gives a lasting shine to varnish, plastic, chrome, etc. and forms an anti static film with drop-repellent effect.

SIZE	QTY/CS	MFG #	PART #
500-ML	12	309451	746211



POWER CLEAN SPRAY

- Cleans and degreases even in the event of stubborn dirt.
- Reliably dissolves oil, grease, tar etc. without leaving behind any residues.
- Cleans ignition plugs, battery terminal posts, electrical connections and contacts.
- Safe for rubber, plastic and varnish.

SIZE	QTY/CS	MFG #	PART #
500-ML	12	302327	746215



SPRAY WITH PTFE

- A dry-film lubricant; it can be used as an anti-friction agent and separating agent that does not leave behind any oily marks.
- With a particle size of 5 µm, the wafer-thin PTFE layer prevents parts from sticking together in designs or systems with machine tools.
- Almost absolute chemical resistance and a very broad service temperature range (+265°C). Anti-static

SIZE	QTY/CS	MFG #	PART #
500-ML	12	302349	746231



CHAINLUBE OFF ROAD

- Chain Lube Off-Road is a full synthetic, water-repellent, clear chain lubricant specifically engineered for off-road motorcycles

SIZE	QTY/CS	MFG #	PART #
500-ML	12	302281	746154



CHAINLUBE RACING SPRAY

- Chain Lube Racing is a light-weight water resistant, white chain lubricant specifically road racing applications.

SIZE	QTY/CS	MFG #	PART #
500-ML	12	302336	746155



CHAINLUBE ROAD STRONG

- Chain Lube Road Strong is a thick, water resistant, white chain lubricant specifically engineered for road riding applications.

SIZE	QTY/CS	MFG #	PART #
500-ML	12	302347	746156



CHAINLUBE ADVENTURE

- Water-resistant, extremely adhesive lubricating film.
- O-ring and X-ring tested.
- Low dirt adhesion.
- High-pressure and sling-off resistant.
- Reduces wear and tear

SIZE	QTY/CS	MFG #	PART #
200-ML	12	307861	746153
500-ML	12	306442	746152



AIR FILTER OIL SPRAY 655

- Specially developed air filter oil spray for foam air filter elements.
- Keeps out sand, dust and water.
- Guaranteed optimal airflow.
- Very good adhesion.

SIZE	QTY/CS	MFG #	PART #
750-ML	12	303080	746133



ACCU PROTECT SPRAY 200 ML

- Protects battery terminal posts, pole terminals, connectors and starter connection cables.
- Prevents corrosion and oxidation.

SIZE	QTY/CS	MFG #	PART #
200-ML	12	302288	746129



CARBURETOR SPRAY

- Cleans air passages, inlet flaps, Venturi tubes, adjustment screw seats and carburetor housings.
- Suitable for all types of carburetor.
- Tested and found suitable for use in carburetor.

SIZE	QTY/CS	MFG #	PART #
500-ML	12	302293	746150



PROTEX SPRAY

- Textile and leather impregnation.
- Highly effective, long-lasting protection against wet conditions and oil.
- Suitable for leather, textiles and microfibers, preserves the natural breath ability of the fabric.

SIZE	QTY/CS	MFG #	PART #
500-ML	12	302329	746230



EASY CUT SPRAY

- Spray for all high-alloyed steel grades as well as non-ferrous metals and aluminum. Increases the machining speed, reduces wear and extends the service life of tools.
- Optimum cooling and lubricating properties

SIZE	QTY/CS	MFG #	PART #
250-ML	12	303792	746178



GUN CARE SPRAY

- Tested and found suitable for use in O-ring and X-ring chains.
- Cleans, lubricates and preserves all metal parts on an ongoing basis.
- Dissolves powder residues and protects against rust.
- Repels moisture and prevents corrosion caused by hand perspiration

SIZE	QTY/CS	MFG #	PART #
300-ML	12	302301	746195

COPPER SPRAY



- Preventing the fusing/sticking of parts subject to high thermal stress such as exhaust screws, ignition plugs, brake pads and heat exchangers.
- Noise-absorbing, oxidation-stable, protects against corrosion, very adhesive, salt-water-resistant and extremely temperature-stable.
- Application range: -40 °C to +1200 °C.

SIZE	QTY/CS	MFG #	PART #
300-ML	12	308778	746163

SILICONE SPRAY



- Lubricant, maintenance product and protecting agent for rubber, plastic and all metal parts
- Temperature-stable from -50 degree C to +200 degree C
- Water-repelling
- Prevents oxidation
- Anti-static

SIZE	QTY/CS	MFG #	PART #
500-ML	12	303082	746271

SPRAY 2000



- Long-acting, fully-synthetic, high-pressure-resistant lubricant for universal application.
- Penetrates rapidly and protects from corrosion.
- Thermally stable against -30°C to +200°C.
- Adhesive, water resistant, silicone free, pressure and impact resistant, colorless.

SIZE	QTY/CS	MFG #	PART #
500-ML	12	302272	746272

HELMET CARE SPRAY



- Cleaning and care foam for helmet shell and inner padding.
- Effective and fast.
- Deodorizes and refreshes colors.
- Protects the surfaces.

SIZE	QTY/CS	MFG #	PART #
200-ML	12	303204	746196

GREASE SPRAY



- Viscous grease spray with a good level of adhesive power; can be used as an alternative to a grease brush.
- Water and salt-water-resistant. Excellent corrosion and wear protection.

SIZE	QTY/CS	MFG #	PART #
500-ML	12	302297	746194

INTACT MX 50 SPRAY



- Universal lubricating and corrosion protection spray.
- Leaves behind a highly effective protective film.
- Repels and undermines water, has outstanding creep properties and prevents corrosion.

SIZE	QTY/CS	MFG #	PART #
500-ML	12	302312	746199

CHAIN CLEAN DEGREASER



- Effectively removes caked on residue
- Tested with X-rings and O-rings

SIZE	QTY/CS	MFG #	PART #
500-ML	12	303087	746151

SUSPENSION CLEANER



- Effective cleaner designed for use on fork legs/stanchions, fork seals, and shock shafts
- Safe for rubber, plastic, and paint
- Removes oil, grease, tar, and other stubborn residues without damaging any seals or o-rings

SIZE	QTY/CS	MFG #	PART #
500-ML	12	310707	746300

MOTUL

300V FACTORY LINE ROAD RACING

Pioneer in synthetic lubricants, Motul has developed the 300V Motorsport range based on the unique ESTER Core® technology that gives you unrivalled power increase, outstanding lubrication and optimal protection, the best conditions for ultimate victory!

*"S" Special Order Only



WEIGHT	SIZE	QTY/CS	MFG#	PART #
5W30	1 LITER	12	104108	987057
5W40	1 LITER	12	104112	987058
5W40	4 LITER	4	104115	987059
5W40	20 LITER	1	104116	987060
5W40	60 LITER S	1	104117	987061
5W40 4T	1 LITER	12	104134	987075
5W40 4T	4 LITER	12	104135	987076
10W40	1 LITER	12	104118	987063
10W40	4 LITER	4	104121	987064

WEIGHT	SIZE	QTY/CS	MFG#	PART #
10W40	20 LITER S	1	104123	987065
10W40	60 LITER S	1	104124	987066
10W40	208 LITER S	1	104370	987067
15W50	1 LITER	12	104125	987068
15W50	4 LITER	4	104129	987069
15W50	20 LITER S	1	104131	987070
15W50	60 LITER S	1	104132	987071
15W50	208 LITER S	1	104133	987072
15W60	1 LITER	12	104137	987077

MOTUL 800 FACTORY LINE 2T

High-rev 2-stroke racing formula, compatible with up to 124-octane gas. For motocross, use MOTUL 800 2T OFF ROAD; for oil injectors, use MOTUL 710 2T.

Road Racing

DESC	QTY/CS	MFG #	PART #
1 LITER	12	104041	987084

Off Road

DESC	QTY/CS	MFG#	PART #
1L	12	104038	987082
4L	12	104039	987083



MOTUL 3000 PLUS 4T 10W40

HC-TECH® 4-stroke engine lubricant for street, off-road bikes, scooters, ATVs, and mopeds, with or without catalytic converters. Works with wet or dry clutches, integrated or non-integrated gearboxes.

*"S" Special Order Only

WEIGHT	SIZE	QTY/CS	MFG#	PART #
10W40	1 LITER	12	107672	987045
10W40	4 LITER	4	107693	987046
10W40	208 LITER S	1	107694	987047
20W50	1 LITER	12	107318	987048
20W50	4 LITER	4	107319	987049
20W50	208 LITER S	1	107305	987050

MOTUL 510 2T

For high-performance 2-stroke engines on bikes, trails, off-road, and enduro bikes. Compatible with oil injectors, premix, leaded/unleaded fuel, biofuels, and catalytic converters.

SIZE	QTY/CS	MFG#	PART #
1 LITER	12	104028	987078
4 LITER	4	104030	987079



MOTUL 710 2T

Synthetic ester-based 2-stroke oil for modern engines with direct injection or carburetors. Anti-smoke, suitable for oil injectors, premix, and catalytic converters.

SIZE	QTY/CS	MFG#	PART #
1 LITER	12	104034	987080
4 LITER	4	104035	987081



MOTUL 7100 4T MOTOR OIL

Synthetic 4-stroke ester-based oil with strong shear resistance, ensuring engine and gearbox protection and smooth shifting. JASO MA2 certified for wet clutches, catalytic converter compatible.

S Special Order Only



WEIGHT	SIZE	QTY/CS	PART #
5W40	1 LITER	12	987000
5W40	4 LITER	4	987001
5W40	20 LITER	1	987002
5W40	208 LITER S	1	987003
10W30	1 LITER	12	987167
10W30	4 LITER	12	987168
10W40	1 LITER	12	987004
10W40	4 LITER	4	987005
10W40	20 LITER S	1	987006
10W40	208 LITER S	1	987007
10W50	1 LITER	12	987008
10W50	4 LITER	4	987009

WEIGHT	SIZE	QTY/CS	PART #
10W50	208 LITER S	1	987010
10W60	1 LITER	12	987015
10W60	4 LITER	4	987016
15W50	1 LITER	12	987011
15W50	4 LITER	4	987012
15W50	20 LITER S	1	987013
15W50	208 LITER S	1	987014
20W50	1 LITER	12	987017
20W50	4 LITER	4	987018
20W50	208 LITER S	1	987019

MOTUL 5100 4T MOTOR OIL

Reliable 4-stroke engine oil for street and off-road bikes, supporting both wet/dry clutches and integrated gearboxes. Ideal for motorcycles with catalytic converters or air injection systems.

S Special Order Only



WEIGHT	SIZE	QTY/CS	PART #
10W30	1 LITER	12	987021
10W30	4 LITER	4	987022
10W30	60 LITER S	1	987023
10W30	208 LITER S	1	987024
10W40	1 LITER	12	987027
10W40	4 LITER	4	987028
10W40	60 LITER S	1	987030
10W40	208 LITER S	1	987031
10W50	1 LITER	12	987032
10W50	4 LITER	4	987033

WEIGHT	SIZE	QTY/CS	PART #
10W50	60 LITER S	1	987034
10W50	208 LITER S	1	987035
15W50	1 LITER	12	987039
15W50	4 LITER	4	987040
15W50	20 LITER S	1	987041
15W50	60 LITER S	1	987042
15W50	208 LITER S	1	987043
10W40	208 LITER USA	1	987026
15W50	208 LITER USA S	1	987038
20W50	1 LITER	12	987162

SCOOTER EXPERT 4T 10W-40 MA

4-stroke scooter oil with wet clutch compatibility, ideal for daily commuting. Works with any gasoline, biofuels included.

WEIGHT	SIZE	QTY/CS	PART #
10W40 MA	1 Liter	12	987089



SCOOTER EXPERT 4T 10W-40 MB

4-stroke oil for scooters without wet clutch. Suitable for all fuels, ideal for urban riding.

WEIGHT	SIZE	QTY/CS	PART #
10W40 MB	1 Liter	12	987090





SCOOTER POWER 2T

100% synthetic Ester oil for 2-stroke scooters at high revs; minimizes wear, smoke, and friction.

WEIGHT	SIZE	QTY/CS	PART #
-	1 LITER	12	987093



TWIN 20W50 MOTOR OIL

100% synthetic, ester-based oil for high-temp twin engines; reduces wear and friction, suitable for primary cases and integrated transmissions. "S" Special Order Only

DESC	QTY/CS	MFG#	PART #
20W50 1 QT	12	108061	987051
20W50 208 L S	1	109609	987052



**SCOOTER POWER 4T
5W-40 MA**

High-performance 4-stroke oil with integrated gearbox and wet clutch, suitable for modern scooters. Compatible with all fuel types.

WEIGHT	SIZE	QTY/CS	PART #
5W40 MA	1 Liter	12	987087



TWIN GEAR & CHAIN CASE OIL

100% ester-based, protects primary drive and transmission, reduces drag, enhances clutch grip.

DESC	QTY/CS	MFG#	PART #
20W50 1 QT	12	108063	987053



SCOOTER EXPERT 2T

Synthetic-based oil for high-rpm 2-stroke scooters, offering strong wear protection and reduced smoke.

WEIGHT	SIZE	QTY/CS	PART #
-	1 LITER	12	987092



GEAR COMPETITION 75W-40

Ester-based, ideal for limited-slip systems under heavy loads and extreme temperatures.

DESC	QTY/CS	MFG#	PART #
1 L	12	105779	987116



**TWIN PRIMARY
& CHAIN CASE OIL**

Primary Drive Fluid: Designed for Big Twin Harley-Davidson wet clutches; enhances lubricity, reduces wear, extends bearing and chain life.

WEIGHT	SIZE	QTY/CS	PART #
1 QT	12	108066	987055



**TWIN GEAR OIL
75W90**

100% synthetic ester fluid for high-temp, shock-resistant performance in Big Twin, 4- to 6-speed transmissions; ideal for Harley-Davidson and similar models.

WEIGHT	SIZE	QTY/CS	PART #
75W90 - 1 QT	12	108064	987054



MOTUL SNOWPOWER SYNTH 2T

100% Synthetic – Ester high performance lubricant specially formulated for snowmobile with 2 Stroke engines working under the most extreme weather conditions: polar cold.

DESC	QTY/CS	MFG#	PART #
1L	12	108209	987108
4L	12	108210	987109



GEAR 300 75W-90

For racing transmissions, 0% shear loss, handles shocks and heavy loads; suitable for extreme conditions.

DESC	QTY/CS	MFG#	PART #
1 L	12	105777	987114
20 L	1	103994	987115



MOTUL SNOWPOWER 4T 0W-40

Specially designed for high performance snowmobiles 4 Stroke engines: Yamaha, Ski-doo/BRP, Artic Cat, Lynx...

DESC	QTY/CS	MFG#	PART #
1L	12	105891	987110
4L	12	105892	987111



GEARBOX 80W90

For heavy loads and noise reduction in mechanical transmissions, SAE 90 grade.

DESC	QTY/CS	MFG#	PART #
1	12	105787	987121



MOTUL 90 PA

Specially formulated for limited-slip differentials : Racing cars, 4WD, Passenger cars, forester and construction vehicles. All types of hypoid differential with or without limited-slip system operating under shocks, heavy loads and low revolution speed or moderate load and high revolution speed.

DESC	QTY/CS	MFG#	PART #
1L	12	111922	987164



TRANSOIL 10W-30

For separate gearbox cases in various motorbikes and ATVs, suitable for SAE 10W-30 or SAE 80.

DESC	QTY/CS	MFG#	PART #
10W30 1L	12	105894	987117



HD 80W90

High-pressure formula for mechanical transmissions; reduces friction and wear, meets API GL-4/GL-5 standards.

DESC	QTY/CS	MFG#	PART #
1L	12	105781	987119



TRANSOIL EXPERT 10W-40

For integrated wet clutch gearboxes, ideal for high-stress conditions.

DESC	QTY/CS	MFG#	PART #
10W40 1L	12	105895	987118



SHOCK OIL FACTORY LINE

For extreme racing conditions, developed with French racing shock manufacturers.

DESC	QTY/CS	MFG#	PART #
1L	6	105923	987131



RBF 600 FACTORY LINE

Extreme High-Performance Brake Fluid: DOT 4 polyglycol fluid, nitrogen-sealed to prevent contamination. Boiling points: 594°F dry, 401°F wet.

DESC	QTY/CS	PART #
RBF 600 500 ml	12	987133



FORK OIL EXPERT

Specially designed for any type of fork, upside-down ("USD") forks or conventional ("right-side-up") forks.

DESC	QTY/CS	MFG#	PART #
5W - Light 1L	12	112950	987169
10W - Medium 1L	12	112952	987170
15W - Medium/Heavy 1L	12	112954	987175
20W - Heavy 1L	12	112948	987176



DOT 5.1

100% Synthetic Brake Fluid: Polyglycol-based, compatible with DOT 5.1, DOT 4, and DOT 3 systems, ABS-specific. Boiling points: 270°C dry, 185°C wet. Standards: FMVSS 116, SAE J 1703.

DESC	QTY/CS	PART #
500 ml	12	987132



MOTUL FORK OIL FACTORY LINE

Hydraulic fluid for high performance applications. Specially developed for SHOWA, KAYABA, OHLINS, WP, MARZOCCHI, FOX, MUPO, and all types of inverted or conventional front suspensions.

DESC	QTY/CS	MFG#	PART #
VL 2.5W 1L	12	112974	987177
L 5W 1L	12	112956	987178
LM 7.5W 1L	12	112968	987179
M 10W 1L	12	112971	987180



RBF 660 FACTORY LINE

High-Performance Brake Fluid: Non-silicone fluid with high boiling points (617°F dry, 400°F wet), designed for extreme temperatures in racing brake systems.

DESC	QTY/CS	PART #
RBF 660 500 ml	12	987134



C5 CHAIN PASTE

High-performance chain grease for road bikes, protecting against wear and corrosion, effective in extreme temperatures.

DESC	QTY/CS	MFG#	PART #
150 ml	12	103513	987147



C1 CHAIN CLEAN

Quickly cleans all chain types, removing dirt and grease. Safe for O-ring, X-ring, and Z-ring chains.

DESC	QTY/CS	MFG#	PART #
400 ml can	12	103243	987143



MOTUL MC CARE C2 CHAIN LUBE ROAD US

All types of chains: standard and with O-RING, X-RING, Z-RING. Street motorcycles, go-karts. Specially recommended for very fast motorcycles, MOTUL CHAIN LUBE ROAD adheres to the chain even at high speeds.

DESC	QTY/CS	MFG#	PART #
400 ml	12	111819	987163



E9 WASH & WAX SPRAY

Waterless cleaner for motorcycle bodies. Removes dirt and stains while depositing a protective wax layer, enhancing shine.

DESC	QTY/CS	MFG#	PART #
400 ml	12	103258	987148



MOTUL MC CARE C3 CHAIN LUBE OFF ROAD US

All types of chains: standard and with O-RING, X-RING, Z-RING. Cross, enduro, trial, trail motorcycles or quads, ATVs.

Specially recommended for off road use: MOTUL CHAIN LUBE OFF ROAD repels sand and soil.

DESC	QTY/CS	MFG#	PART #
400 ml	12	111820	987165



E10 SHINE & GO SPRAY

Silicone-based polish that revives and protects plastic and painted surfaces. Leaves a non-stick, water-repellent film for lasting protection.

DESC	QTY/CS	MFG#	PART #
550 ml	12	108093	987151



E2 MOTO WASH

Biodegradable deep cleaner for motorcycles. Removes grease, dust, and residues while leaving a protective anti-corrosion film. Safe for paint and varnish.

DESC	QTY/CS	MFG#	PART #
1L CAN	12	104881	987149



MOTOCOOL EXPERT

- Ready to use cooling liquid, anti-freeze and anti-corrosion for bikes cooling systems.
- Based on monoethyleneglycol
- Protects the cooling system from freezing (-37°C / -35°F) and metallic parts from corrosion.
- Avoid engine overheating with its high boiling point: 135°C / 275°F (at +1.5 bar).

DESC	QTY/CS	MFG#	PART #
1 QUART	12	111764	987135
60 LITERS	1	105919	987137



E7 INSECT REMOVER

Quickly dissolves insect residues, bird droppings, and organic stains on cars and motorcycles. Safe for glass, plastic, and paint.

DESC	QTY/CS	MFG#	PART #
400 ml	12	103002	987153



MOTOCOOL FACTORY LINE

- Organic Formula
- Ready to use coolant (do not dilute) for motorcycles.
- Nitrite free, amine free, phosphate free, borate free, silicate free
- System must be flushed prior to use
- Super high boiling point: 277oF (136oC)
- Exceptional freezing protection -31°F(-35°C)

DESC	QTY/CS	MFG#	PART #
20 LITERS	1		987138



ROAD CHAIN CARE KIT

A complete kit for drive chain cleaning and lubrication, for either road or offroad applications

Kit Includes:

- 9.3oz can of chain lube
- 9.8 can of chain clean
- Chain brush
- Black nitrile gloves
- Motul sticker

DESC	QTY/CS	MFG#	PART #
Chain Care Kit	-	109767	987160



MOTUL MC CARE C4 CHAIN LUBE FACTORY LINE US

All types of chains:

standard and with O - RING, X-RING, Z-RING. A result of Motul's experience in motorcycle racing, only for road use (sticky product), MOTUL CHAIN LUBE Factory Line is a lubricant specifically developed to lubricate racing motorcycle chains: Road Racing and Endurance. Specially recommended for very fast bikes, MOTUL CHAIN LUBE Factory Line adheres to the chain even at high speeds.

DESC	QTY/CS	MFG#	PART #
400 ml	12	111821	987166



OFF ROAD CHAIN CARE KIT

The Motul Off-Road Chain Care Kit is the right solution to maintain your powersports machine and equipment.

Kit Includes:

- Motul C1 Chain Clean
- Motul C3 Chain Lube Off Road
- Chain Brush
- Nitrile Gloves
- Motul Logo Sticker

DESC	QTY/CS	MFG#	PART #
Chain Care Kit	-	109788	987161



MOTUL MC CARE C4 CHAIN LUBE FACTORY LINE US

Neutral and non-aggressive cleaner for the outside of the helmet and visor. Cleans helmet exteriors and visor without leaving streaks.

DESC	QTY/CS	MFG#	PART #
250 ml	12	103250	987155



MOTUL KART GRAND PRIX 2T

Formula specially developed for racing GO KARTS. Suitable for all kinds of gasoline fuels, leaded or unleaded, biofuels.

DESC	QTY/CS	MFG#	PART #
1L	12	105884	987085



MOTUL POWERJET 2T

For Jet Ski, Water Scooter, PWC – Personal Water Craft, Watercraft,... 2 Stroke engines, Direct Injection or carburetors, lubricated by premix or by oil injector: KAWASAKI, YAMAHA, POLARIS, BRP.

DESC	QTY/CS	MFG#	PART #
4L	12	105873	987103



MOTUL ATV POWER 5W-40 4T

Suitable for all type of gasoline fuels, leaded or unleaded, with or without Ethanol, biofuels.

DESC	QTY/CS	MFG#	PART #
1L	12	105897	987094



MOTUL SNOWPOWER 2T

Specially formulated for snowmobile with 2 stroke engines working under the most extreme weather conditions: polar cold.

DESC	QTY/CS	MFG#	PART #
1L	12	105887	987105
4L	12	105888	987106



MOTUL ATV-UTV 4T 10W-40

Suitable for all type of gasoline fuels, leaded or unleaded, with or without Ethanol, biofuels.

DESC	QTY/CS	MFG#	PART #
4L	12	105879	987102



MOTUL ATV SXS POWER 10W-50 4T

Suitable for all type of gasoline fuels, leaded or unleaded, with or without Ethanol, biofuels.

DESC	QTY/CS	MFG#	PART #
4L	12	105901	987097





MYSTIK JT-6 HIGH PERFORMANCE MARINE GREASE #2 1 LB



Mystik JT-6 Marine Multi-Purpose #2 Grease is a smooth but tacky blue grease with outstanding water resistance. It is designed to provide excellent lubrication for greased chassis points and other wet-environment applications.

Features

- Premium high-performance extreme pressure (EP) marine grease.
- Outstanding water washout resistance and protection against saltwater corrosion.
- Excellent wear protection and load-carrying capability.
- Polymer-fortified for excellent metal adhesion.
- Lubricates well over a wide temperature range (0 to 250°F).

DESC	MFG#	PART #
Marine Grease 1lb	665065002038	422001



LUBRIPLATE L0034-094 NO. 105 MOTOR ASSEMBLY GREASE, 10 OZ

The LUBRIPLATE “100” Series Products are excellent water-resistant lubricants designed for plain bearings, cams, slides and similar applications up to operating temperatures of 150°F. LUBRIPLATE No. 100 and No. 105 are excellent lubricants for coating engine parts when assembling either a new or rebuilt engine. They are excellent rust preventive greases. Specifications Fluid Type mineral ISO Viscosity Grade of Base Oil 68 NLGI Grade 0 Thickeners Calcium Food Grade - NSF H1 No Color White Dropping Point (F°) 170 Dropping Point (C°) 77 Operating Temp Range -25 to 140”

DESC	MFG#	PART #
Motor Assembly Grease 10oz	LBRP105	422002



8-OZ NOVUS PLASTIC POLISH #1: CLEAN & SHINE



NOVUS Plastic Polish #1 Clean and Shine gently cleans and polishes plastic and acrylic surfaces without harsh chemicals. Ideal for helmet shields, windshields, and more, it resists smudges and fingerprints for a lasting, clear shine.

DESC	QTY/CS	MFG#	PART #
8 oz	12	7020	NO7020
2 oz	12	7026	NO7026

8-OZ NOVUS PLASTIC POLISH #2: FINE SCRATCH REMOVER



NOVUS Plastic Polish #2 Fine Scratch Remover eliminates fine scratches and abrasions, restoring clarity and shine to worn plastic surfaces. Perfect for shields, headlamps, and equipment, it brings surfaces back to like-new condition.

DESC	QTY/CS	MFG#	PART #
8 oz	12	7030	NO7030
2 oz	12	7033	NO7033

8-OZ NOVUS PLASTIC POLISH #3: HEAVY SCRATCH REMOVER



NOVUS Plastic Polish #3 Heavy Scratch Remover eliminates deep scratches and damage on heavily worn plastic surfaces. Ideal for restoring clarity to weathered acrylics, it's the perfect first step before fine polishing.

DESC	QTY/CS	MFG#	PART #
8 oz	12	7080	NO7080
2 oz	12	7081	NO7081

NOVUS POLISH MATES 6 PACK



Avoid scratches when cleaning plastics—use NOVUS Polish Mates instead of paper towels or synthetic cloths. Sold in a 6-pack, these soft, low-lint, durable wipes are highly absorbent and abrasion resistant for safe, effective cleaning.

DESC	QTY/CS	MFG#	PART #
Polish Mates	6	7069	NO7069



ORIGINAL BIKE SPIRITS SPRAY CLEANER & POLISH – CLEANS, POLISHES & PROTECTS – 14 OZ

Original Bike Spirits Spray Cleaner and Polish is the ultimate “detailer in a can” for any motorcycle, ATV, scooter, or power equipment. With its unique, waterless formula, this motorcycle cleaner makes cleaning your bike simple, leaving a stunning shine. Designed to clean, polish, and protect surfaces, it’s perfect for on-the-go detailing with anti-static properties that help repel dirt and dust.

DESC	MFG#	PART #
Spray Cleaner and Polish 14 oz	1039615	650621

PERFORMANCE TOOL



MULTI-PURPOSE LITHIUM GREASE

Lubricate a wide range of equipment with this multipurpose lithium grease.



- Multi-purpose lithium based grease is designed for light duty applications which require extended lubrication.
- For light duty automotive, industrial, agricultural or commercial equipment.
- Smooth consistency, water resistant and extremely stable.
- Use on springs, water pumps, bearings, chassis fittings and any general lubrication projects.
- National Lubricating Grease Institute (NLGI) #2

DESC	MFG#	PART #
2-Pack 3 oz. Multi Purpose	W54206	260068



FAST ORANGE PUMICE AND SMOOTH LOTION HAND CLEANER

Biodegradable citrus-based waterless hand cleaner with pumice for tough dirt. Gentle on skin with aloe, lanolin, and glycerin. Also works on stains, scuff marks, tile, and odors.



PUMICE LOTION

DESC	QTY/CS	MFG#	PART #
7.5 Fluid oz Bottle	12	25108	AG25108
1 Gallon Bottle w/ Pump	4	25219	AG25218

SMOOTH LOTION

DESC	QTY/CS	MFG#	PART #
7.5 Fluid oz Bottle	12	23108	AG23108
1 Gallon Bottle w/ Pump	4	23218	AG23218



FAST ORANGE PUMICE BAR HAND SOAP

Fast Orange® Pumice Bar Hand Soap, 5.75 oz, removes oil, grease, grime, paint, and more. Contains fine pumice for deep cleaning while leaving hands soft. Ideal for automotive technicians.

DESC	MFG#	PART #
5.75 oz Bar	25575	AG25575



ULTRA-BLACK GASKET MAKER

Ultra Black® OEM-specified gasket maker for drivetrain warranty compliance. Fast-curing, sensor-safe, low odor, noncorrosive, and oil-resistant. Retains flexibility, resists fluids, vibration, and temps from -65°F to 500°F.

DESC	MFG#	PART #
3.35 oz Tube, Carded	82180	AG82180



ULTRA-BLUE RTV SILICONE GASKET MAKER

OEM-specified RTV gasket maker for high-torque, high-vibration import engines. Sensor-safe, low odor, noncorrosive, and leak-proof. Resists oils, coolant, and fluids with max vibration protection. Withstands -65°F to 500°F.

DESC	MFG#	PART #
3.35 oz Tube, Carded	81724	AG81724



ANTI-SEIZE LUBRICANT

A highly refined blend of aluminum, copper and graphite lubricants. Use during assembly to prevent galling, corrosion and seizing due to weathering or chemicals. Anti-Seize assures easier disassembly. Temperature range: -60° F to 1600° F (-51° C to 871° C). Salt, corrosion and moisture resistant – ideal for marine use.

DESC	MFG#	PART #
1 oz Tube, Carded	81343	AG81343
4 oz Brush Top Bottle	80071	AG80071



MEDIUM STRENGTH THREADLOCKER BLUE GEL

OEM-specified medium-strength gel threadlocker with GEL TWIST™ applicator for precise use. Locks and seals 1/4”–3/4” fasteners, prevents vibration loosening, and protects against corrosion. Removable with hand tools. Meets ASTM D 5363 AN0321 specs.

DESC	MFG#	PART #
10g Gel Twist Applicator, Carded	24010	AG24010



ELIMINATOR II® ENGINE DEGREASER

Quickly dissolves and removes grease, oil and dirt from all types of equipment. Cleans iron, steel, aluminum, magnesium and copper. Not harmful to metal, rubber, plastic, or concrete. Rinses off easily with water. Suggested applications: engines, garage floors, tools, machinery. Sold each.

DESC	MFG#	PART #
15 oz. Aerosol	80043	AG80043



HIGH STRENGTH THREADLOCKER RED GEL

OEM-specified high-strength gel threadlocker with GEL TWIST™ applicator for precise use. Permanently locks 3/8”–1” fasteners, studs, and press fits with 3,000 PSI holding power. Resists vibration loosening; may require heat or tools for removal. Meets ASTM D5363 AN0221 specs.

DESC	MFG#	PART #
10g Gel Twist Applicator, Carded	27010	AG27010



CHAIN LUBE

Cleans, lubricates, extends life and protects all types of roller chains, gears and cables that operate under exposed conditions. Easy-to-apply foaming action assures effective application. Repels dirt, sand, dust. Minimal “throw - off”. Contains no ODC’s. Suggested Applications: Ideal for any chain-driven tool or vehicle such as motorcycles, mopeds, chainsaws, lawnmowers and bicycles. Sold each.

DESC	MFG#	PART #
5 oz. Aerosol	80075	AG80075



NON-CHLORINATED BRAKE & PARTS CLEANER

Penetrates, dissolves and removes dirt and oil from brake systems and metal parts. Safer for aluminum. Leaves no contaminant-attracting residue or chlorinated solvent run-off. Helps manage EPA halide limits. *NFPA Fire Code 30B.

DESC	MFG#	PART #
20oz Aerosol Can	82220	AG82220



BATTERY CLEANER

Spray it on and wash corrosion off. Works in just three minutes. Suggested applications: automotive, marine, farm machinery and motorcycle batteries. Sold each.

DESC	MFG#	PART #
5.75 oz. Aerosol Can	80369	AG80369



“ORIGINAL” SPRAY CLEANER DETAILER

Pig Spit restores and brightens dull or faded motors, trim, and components. Easy to apply with no rubbing, it leaves a clean, like-new finish that lasts even outdoors. Safe for nearly all surfaces.

DESC	QTY/CS	MFG#	PART #
9 oz spray	6	PSO	232005



SPIT GLASS AND PLEXI CLEANER

PIG SPIT Glass Cleaner delivers advanced clarity with a streak-free formula that removes dirt and grime for a crystal-clear finish. Quick to apply and safe for most glass surfaces, it enhances visibility and promotes safer driving.

DESC	QTY/CS	MFG#	PART #
13 oz spray	6	PSGP	232099



FAST DETAIL SPRAY BOTTLE

Pig Spit Fast Detail is a quick-cleaning spray for light dust, smudges, and fingerprints. It delivers instant shine to metal, chrome, plastic, and paint while leaving a protective layer that repels dust and water. Easy to use and ideal for all types of vehicles.

DESC	QTY/CS	MFG#	PART #
16 oz spray	6	PSFD16	232100



LEATHER CLEANER AND CONDITIONER

This versatile leather cleaner and conditioner is perfect for motorcycles, cars, RVs, boats, and more. It deeply cleans without damage, conditions to prevent cracking, and adds UV protection to preserve color. Easy spray-on application for fast, effective care.

DESC	QTY/CS	MFG#	PART #
16 oz spray	6	PSLC16	232101



WHEEL CLEANER

This versatile wheel cleaner is safe for all wheel types—chrome, aluminum, painted, and alloy. Its powerful, pH-balanced formula removes brake dust and grime, while leaving a protective barrier to keep wheels cleaner longer. Just spray, wait, and rinse for a brilliant finish.

DESC	QTY/CS	MFG#	PART #
16 oz spray	6	PSWC16	232102



PJ1 PRIMER

PJ1 PRIMER is a fast-dry primer that provides maximum rust protection and adhesion for a finishing top coat. PJ1 PRIMER is available in both WHITE & GRAY and can be used with lacquer, enamel, and acrylic paints. It is a multi-purpose product and can be used on metal, fiberglass, wood, and most plastic surfaces.

DESC	QTY/CS	MFG#	PART #
Gray 12 oz.	6	18-PRMG	909085
White 12 oz.	6	18-PRMW	909086



GOLDFIRE MOTOR OIL

PJ1 Goldfire Synthetic 4T Motor Oil is formulated for modern air- and water-cooled 4-stroke engines. With detergents, anti-corrosion, and anti-wear additives, it ensures optimal lubrication for engine, transmission, and clutch—preventing issues caused by automotive oils.

DESC	QTY/CS	MFG#	PART #
10W-40 1L	6	9-50	909006



PJ1 RENEW AND PROTECT

Restores the original luster to old weathered surfaces. Re-New & Pro-Tect guards against the deteriorating effects of smog, UV Rays, moisture and weather which can bleach, dull or harden materials exposed to the elements.

DESC	QTY/CS	MFG#	PART #
8 oz.	6	23-8	909049



PJ1 FAST BLACK PORCELAIN HARD EPOXY PAINT

SUPER TOUGH EPOXY PAINT

Dries to an extremely hard and durable finish. Gloss black. 250oF. Sold each.

DESC	QTY/CS	MFG#	PART #
11 oz	6	16-GLS	909054



SILVERFIRE PETROLEUM 4T MOTOR OIL

PJ1 Silverfire Petroleum 4T Motor Oil is designed for modern air- and water-cooled 4-stroke engines. Its detergents, anti-corrosion, and anti-wear additives ensure proper lubrication of engine, transmission, and clutch, preventing problems caused by automotive oils.

DESC	QTY/CS	MFG#	PART #
10W-40 1 Liter	6	9-50-PET	909010
10W-40 1 Gallon	6	9-50-1G-PET	909011



PJ1 WRINKLE BLACK

HIGH TEMPERATURE TEXTURED FINISH PAINT

Withstands 350°F (177°C). Has wrinkle textured finish. Sold each.

DESC	QTY/CS	MFG#	PART #
11 oz	6	16-WKL	909055





PJ1 FILTER CLEANER

CLEANS FOAM AND FABRIC FILTERS

For foam and fabric filters. Easy to use: spray on - wash off. Won't harm glues. Sold each.

DESC	QTY/CS	MFG#	PART #
15 oz	6	15-22	909036



PJ1 FOAM FILTER CARE KIT

Includes (1) 13 oz can of Foam Filter Cleaner and (1) 13 oz can of Foam Filter Treatment Spray. Easy to use spray-on cleaner quickly dissolves dirt and grime. Super tacky formula traps more dirt yet enables maximum air flow.

DESC	QTY/CS	MFG#	PART #
28 oz	6	15-202	909037



PJ1 FAST BLACK 1,500^o F EXHAUST PAINT

SPECIFICALLY DESIGNED FOR EXHAUST SYSTEMS

Withstands 2000°F (1093°C). Flat finish. Sold each.

DESC	QTY/CS	MFG#	PART #
11 oz	6	16-HIT	909051

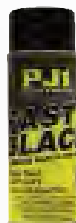

PJ1 500[®] F FAST BLACK ENGINE AND CASE PAINT

FOR ENGINES AND CRANK CASES

Withstands up to 500°F (260°C). Sold each.

DESC	QTY/CS	MFG#	PART #
Gloss Black, 11 oz	6	16-ENG	909052
Black Satin, 11 oz	6	16-SAT	909053



PJ1 PROFESSIONAL CARTRIDGE PRO FORK FLUID

FOR HIGH PERFORMANCE SUSPENSION

Meets or exceeds OEM specifications for Showa and Kayaba cartridge/twin chamber forks. Improves damping and rebound action of all conventional and inverted cartridge fork units. PJ1's Ultra High Viscosity Index formula far exceeds all OEM specifications for a noticeable improvement in suspension response and handling, translating to better lap times. Contains special additives that reduce "stiction" by controlling seal swelling, providing a smoother more sensitive response from the forks. Will not fade or change viscosity due to hot or cold climates nor break down like other cartridge fork oils. Sold per bottle.

DESC	QTY/CS	MFG#	PART #
1 Liter	6	10-32KS	909032



PJ1 BLUE LABEL CHAIN LUBE

OPTIMIZED FOR O-RING/X-RING CHAINS

Clear formula won't fly off. Has a "memory" that bounces back to absorb chain lash. Reduces chain stretch and the requirement for frequent adjustments. Lubricates between roller and sprocket. Preserves O-Rings. Can also be used on standard chains. Sold each.

DESC	QTY/CS	MFG#	PART #
5 oz	12	1-08	909002
13 oz	6	1-22	909003



PJ1 CLUTCH TUNER 2 T GEAR OIL

FOR NON-MOTOR OIL WET CLUTCH APPLICATIONS

Penetrates deep into the chain. Lubricates pins, rollers, side plates, and sprocket. Reduces chain stretch and the requirement for frequent adjustments. Has a "memory" to bounce back to absorb the shock that other chain lubricants can't. Protects chain against the elements. Sold each.

DESC	QTY/CS	MFG#	PART #
5 oz	12	1-06A	909000
13 oz	6	1-20	909001



PJ1 OCTANE PLUS®

OCTANE BOOSTER AND FUEL STABILIZER

Increases fuel octane. Stabilizes fuel. Increases horsepower. Lead substitute for engines requiring leaded fuel. Reduces "Knock" and "Ping". Alleviates dieseling. Helps prevent gas line freeze-up. For 2 and 4 stroke engines. Sold per bottle.

DESC	QTY/CS	MFG#	PART #
16 Fluid oz	6	13-16	909039



PJ1 RENEW AND PROTECT®

NON OILY SURFACE TREATMENT

Unique, super silicone formula provides a penetrating moisturizer. Restores original appearance. Leaves satin not glossy finish. For rubber, vinyl, plastic, wood and treated leather. Sold per bottle.

DESC	QTY/CS	MFG#	PART #
16 Fluid oz	12	23-16	909050



PJ1 SUPER CLEANER

MULTI-APPLICATION NON-RESIDUE DEGREASER

High pressure blasts. Powerful solvents melts grease and grime away. Dries quickly. Leaves no residue. Sold each.

DESC	QTY/CS	MFG#	PART #
13 oz	6	3-21	909041



PJ1 PROFESSIONAL CONTACT CLEANER

PROFESSIONAL CONTACT CLEANER

Powerful spray. Removes Carbon and contaminants from plugs, points, and electrical components. Sold each.

DESC	QTY/CS	MFG#	PART #
13 oz	6	40-3-1	909048

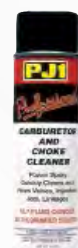

PJ1 PROFESSIONAL CARBURETOR AND CHOKE CLEANER

EXTERNAL CARBURETOR AND CHOKE CLEANER

Powerful spray that quickly cleans and frees valve, injector jets, and linkages. Not harmful to rubber, vinyl or neoprene. Sold each.

DESC	QTY/CS	MFG#	PART #
16 oz	6	40-1	909044



PJ1 FABRIC AIR FILTER TREATMENT

FUEL SYSTEM CLEANER AND TREATMENT

Filters airborne debris to protect your engine. Easy to use - no waste. Water proof. Sold each.

DESC	QTY/CS	MFG#	PART #
15 oz	6	4-20	909033

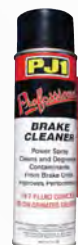

PJ1 PROFESSIONAL BRAKE CLEANER

PROFESSIONAL POWER BRAKE CLEANER

Powerful spray that cleans and degreases contaminants from brake units. Evaporates quickly and leaves no residue. Improves braking performance. Sold each.

DESC	QTY/CS	MFG#	PART #
13 oz	6	40-2-1	909046



PJ1 FOAM AIR FILTER OIL

Available in liquid and aerosol package for quick, easy application. Petroleum and synthetic oil soluble. Sold each.

DESC	QTY/CS	MFG#	PART #
Aerosol, 13 oz	6	5-20	909034
Liquid, 16 Fluid oz	6	5-16	909035



PJ1 CABLE LUBE

PJ1 CABLE LUBE is specially formulated with extreme pressure lubricants to extend the life of all clutch, brake and throttle cables providing smoother and more precise operation.

DESC	QTY/CS	MFG#	PART #
11 oz.	6	1-12	909057



PJ1 PRO CONTACT CLEANER

PJ1 PROFESSIONAL CONTACT CLEANER removes carbon and other contaminants from spark plugs, ignition points, generator parts and all other electrical components.

DESC	QTY/CS	MFG#	PART #
13 oz.	6	40-3	909089



PJ1 SPRAY & WASH DEGREASER

PJ1 SPRAY & WASH DEGREASER quickly penetrates to dissolve grease, dirt and soil. PJ1 SPRAY & WASH DEGREASER can be used on any surface of equipment without leaving residue or other build-up. It's safe and easy to use on all your machines mechanical parts.

DESC	QTY/CS	MFG#	PART #
15 oz.	6	15-20	909079



PJ1 FABRIC FILTER CARE KIT

PJ1 FABRIC AIR FILTER OIL SPRAY will increase the efficiency of your air filter and comes equipped with PJ1 special formulation dye to let you know when gauze-type filter elements need to be serviced. It's easy to apply, improves performance of all gauze-type filter elements, repels water and filters out sand and dirt.

DESC	QTY/CS	MFG#	PART #
30 oz.	6	15-204	909080



PJ1 SUPER CLEANER

PJ1 SUPER CLEANER can be used for pre-assembly of motors, carburetors and brake systems to quickly clean and evaporate leaving no residue or moisture on a prepared surfaces.

DESC	QTY/CS	MFG#	PART #
13 oz.	6	3-20	909087



PJ1 HIGH GLOSS CLEAR ACRYLIC

PJ1 HIGH GLOSS CLEAR ACRYLIC provides a high gloss clear coat for your newly painted metal surfaces. PJ1 is corrosion and chemical resistant and provides UV protection to your coated surface.

DESC	QTY/CS	MFG#	PART #
12 oz.	6	17-CLR	909081



PJ1 PRO BRAKE CLEANER

PJ1 PROFESSIONAL BRAKE CLEANER removes harmful contaminants from motorcycle disc or drum brake components by cleaning, degreasing and evaporating to leave a clean, dry surface.

DESC	QTY/CS	MFG#	PART #
13 oz.	6	40-2	909088



PJ1 OEM COLOR MATCH PAINT

PJ1 OEM COLOR MATCH PAINTS are custom formulated to produce an extremely tough, long lasting, rust resistant finish. PJ1 was designed to provide factory color match capabilities for various powersports frame applications.

DESC	QTY/CS	MFG#	PART #
Honda® Red 12 oz.	6	17-HRO	909082
Kawasaki® Green 12 oz.	6	17-KGO	909083
KTM® Orange 12 oz.	6	17-KTM	909090
Yamaha® Blue 12 oz.	6	17-YB8	909084



PLEXUS PLASTIC CLEANER PROTECTANT & POLISH

- Plexus seals the pores in plastic surfaces with a micro-thin layer of shiny, protective wax, making it resistant to debris, oil, scratches, and eventual yellowing
- Developed for use in the aviation industry - specifically, for cleaning and protecting aircraft windshields and painted surfaces, people quickly discovered it could be used on a limitless variety of plastic surfaces
- Use it on your vinyl windows, hatch covers, mirrors, laminated surfaces, eyeglasses, sunglasses, computer screens; just about any place you would normally use plastic cleaner
- Its convenient aerosol applicator prevents dripping, leaking, evaporating, and coagulating at the tip of the nozzle (as is common with pumps and squeeze bottles)
- Plexus makes colored plastics vibrant, makes clear plastic virtually transparent, and leaves plastic paints gleaming like new

DESC	MFG#	PART #
Plexus 7oz	20207	PL20207
Plexus 13oz	20214	PL20214



S100 TOTAL CYCLE CLEANER

If you've been using a bucket of car suds or a quick detailer, chances are you been missing the most important and threatened places on your bike...those hidden nooks and crannies where dirt can hide.

DESCRIPTION	QTY/CS	PART #
1 Liter Deluxe Kit	12	650283
1 Liter Refill	12	650284
5 Liter Canister	2	650285
500 ml Starter	12	650286
21 oz. Aerosol	12	650287
Sprayer for 5 Liter Canister w/6 ft. Hose	1	650300



S100 CYCLE CARE GIFT SET

The S100 Cycle Care Set is the ideal gift for any bike owner! This organized kit includes five top S100 products to keep a bike in peak condition, all in a convenient carry case—perfect for ultimate bike care.

DESCRIPTION	QTY/CS	PART #
Cycle Care Gift Set	4	650296



S100 WHEEL CLEANER

S100 Gel Wheel Cleaner offers powerful, safe cleaning for tough brake dust, clinging to wheels for a like-new shine on all finishes.

DESCRIPTION	QTY/CS	PART #
500 ml	12	650291



S100 DETAIL & WAX

S100 Detail + Wax is perfect for light cleanups, removing dust, spots, and bug residue while adding a carnauba-beeswax shine. Just spray, wipe, and enjoy a polished finish—ideal for quick touch-ups on the go.

DESCRIPTION	QTY/CS	PART #
10 oz.	12	650294



S100 DETAILING SET & SWABS

The S100 Detailing Set makes precision bike care easy with 25 flexible swabs for polishing. Perfect for applying S100 cleaners and protectants!

DESCRIPTION	QTY/CS	PART #
Detailing Set	12	650297
Detailing Swabs	12	650298



S100 FINISH RESTORER

S100 Finish Restorer is your go-to for tough stains, dulling, and corrosion. It restores metals to a brilliant shine and even helps remove small plastic scratches—all without harsh smells.

DESCRIPTION	QTY/CS	PART #
3.56 oz.	15	650293



S100 POLISHING SOAP

S100 Polishing Soap makes quick work of dulling and tarnish on large metal surfaces. Just wet the sponge, apply, and rinse for a fast, brilliant shine—no residue, and it lasts longer than regular polish.

DESCRIPTION	QTY/CS	PART #
10.6 oz.	12	650299



S100 ENGINE BRIGHTENER

Restore your bike's faded black engine to a factory-new look with S100 Engine Brightener. The easy mist spray reaches deep into fins and crannies, bringing back lasting black and durability through multiple washes.

DESCRIPTION	QTY/CS	PART #
6.2 oz.	12	650295

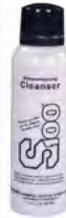

S100 SHINE-ENHANCING CLEANSER

Achieve the ultimate shine with the S100 two-step Cleanser and Paste Wax system. Start with the Shine-enhancing Cleanser to remove water spots and road film, ensuring a flawless surface for a stunning finish without scratching.

DESCRIPTION	QTY/CS	PART #
350 ml	12	650289



S100 CARNAUBA PASTE WAX

Get a stunning shine with S100 Carnauba Paste Wax, made from the hardest carnauba and beeswax. This easy-to-apply wax eliminates powdering and white stains, enhancing dark surfaces without hassle.

DESCRIPTION	QTY/CS	PART #
6.2 oz.	12	650288



S100 SPECIAL SURFACES CLEANER

S100 Special Surfaces Cleaner is a waterless spray that quickly restores plastics, fairings, and windshields. It removes bugs and road film for a crystal-clear finish—perfect for your saddlebag!

DESCRIPTION	QTY/CS	PART #
300 ml	12	650301



RENTHAL GRIP GLUE

Highly developed grip glue, specially formulated to give a secure bond without damaging the grip. Eliminates grips slipping and sliding in the heat of the action. A must when using medium or soft compound Renthall grips.

DESCRIPTION	QTY/CS	PART #
Grip Glue	6	941482



RENTHAL QUICK BOND GRIP GLUE

Secure in just three minutes, Fast-acting liquid adhesive is chemically engineered to bond grips to all handlebars in a matter of minutes, Specially formulated to allow users to apply glue to bar and grip, fit the grip and position into the best position before creating a safe and secure bond between the grips and handlebar

DESCRIPTION	QTY/CS	PART #
Grip Glue Quick Bond	6	941483



STA-BIL MARINE FORMULA ETHANOL TREATMENT

WITH EXTRA CORROSION PROTECTION & FUEL SYSTEM CLEANING TO HELP PREVENT CORROSION DAMAGE AND IMPROVE ENGINE PERFORMANCE YEAR-ROUND

Designed to fight many of the damaging effects of ethanol in gasoline in marine fuel systems (from fuel tanks which vent to the air), and the marine environment (more moisture in the air), which can result in greater problems with: Corrosion - from ethanol-induced water attraction & condensation from temperature changes; Fuel System Deposits - ethanol acts as a solvent on accumulated deposits, causing engine performance problems

Compared with regular STA-BIL, new MARINE Formula STA-BIL has: - Extra Corrosion Protection: DOUBLE the corrosion preventer – to prevent corrosion damage to fuel tanks, fuel pumps, fuel lines, carburetors and injectors, - Extra Fuel System Cleaning: A COMPLETE fuel system cleaner, with more than 4 TIMES the cleaner – to clean-up power-robbing deposits from fuel lines, carburetors, fuel injectors and intake valves

DESC	MFG#	PART #
Quick Measure 8 oz, Sold Each	22239	STA22239
Quick Measure 32 oz, Sold Each	22240	STA22240



FUEL STABILIZER

WITH EXTRA CORROSION PROTECTION & FUEL SYSTEM CLEANING TO HELP PREVENT CORROSION DAMAGE AND IMPROVE ENGINE PERFORMANCE YEAR-ROUND

- Eliminates the need to drain fuel prior to storage
- Ensures quick, easy starts after storage
- Prevents gum and varnish build-up
- Effective in all gasoline, including Ethanol blends up to E-85
- For all gasoline engines, including 2-cycle
- Perfect for collector cars, generators, lawn mowers, snow blowers, etc.
- Does not contain alcohol

USAGE DIRECTIONS:

1 oz. treats up to 2½ gallons of fuel. Use STA-BIL® only with FRESH FUEL, and keep gas can or tank 95% full to avoid condensation build up in tank during storage. Run engine for 5 minutes after adding product to treat entire fuel system.

DESC	QTY/CS	MFG#	PART #
4 oz Carded, Sold Each	24	22204	STA1104
Quick Measure 8 oz, Sold Each	12	22208	STA1118
Quick Measure 1 qt, Sold Each	12	22214	STA1132



STA-BIL ETHANOL TREATMENT AND PERFORMANCE IMPROVER

- Prevents Ethanol fuel related damage in vehicles and small engines
- Prevents corrosion damage and helps remove water
- Stabilizes fuel to keep it fresh during storage
- Cleans fuel system for improved in-season performance
- For use at every fill up for optimal protection
- Use in all gasoline-powered vehicles including: cars, trucks, small engines, lawnmowers, chainsaws, snowmobiles, snow blowers
- Product does not contain alcohol

USAGE DIRECTIONS:

For in-season use: 1 oz. (30mL) treats up to 5 gallons (19L) of fuel

For storage: Use 1 oz. (30mL) to 2½ gallons (9.5L)

DESC	QTY/CS	MFG#	PART #
10 oz, Sold Each	24	22264	452002



ISO-HEAT WATER REMOVER AND FUEL SYSTEM ANTIFREEZE

#1 selling Brand of premium gas-line antifreeze. Absorbs 5 times more water than regular gas-line antifreeze. Designed for year round use in all 2-cycle and 4-cycle gas & diesel engines. Removes water from fuel system. Prevents rust and corrosion. Sold per bottle.

DESC	QTY/CS	MFG#	PART #
16 oz, Sold Each	6	10406	STA10406



ISO-HEAT WATER REMOVER AND FUEL SYSTEM ANTIFREEZE

#1 selling Brand of premium gas-line antifreeze. Absorbs 5 times more water than regular gas-line antifreeze. Designed for year round use in all 2-cycle and 4-cycle gas & diesel engines. Removes water from fuel system. Prevents rust and corrosion. Sold per bottle.

DESC	QTY/CS	MFG#	PART #
12 oz, Sold Each	24	28202	STA5360



HEET #1 GAS-LINE ANTIFREEZE & WATER REMOVER

#1 selling Brand of gas-line antifreeze and water remover. Safe for use in all 4-cycle engines including fuel injected engines. Prevents gas-line freeze-up. Removes water from fuel system. Prevents rust and corrosion. Sold per bottle.

DESC	QTY/CS	MFG#	PART #
12 oz, Sold Each	24	28201	STA5120



FOGGING OIL

Coats internal engine components to prevent corrosion. Displaces moisture from metal to protect engine. Lubricates cylinders to prevent cylinder damage (scuffing) at start up. For all 2-cycle and 4-cycle gasoline engines. Use in all gasoline-powered vehicles including: cars, trucks, small engines, lawnmowers, chainsaws, snowmobiles, snow blowers. Sold per can.

DESC	QTY/CS	MFG#	PART #
12 oz, Sold Each	6	22001	STA1210



CARBURETOR & CHOKE CLEANER

Dissolves gum, varnish, dirt and carbon deposits. Assures faster starts, smooth idling. Extension tube included. Helps restore performance and gas mileage. Sold per can.

DESC	QTY/CS	MFG#	PART #
12.5 oz, Sold Each	12	22005	452005



FORK AND SHOCK FLUID

- The highest quality in suspension fluid
- Designed for longer lasting fluid life
- Same fluid used by many top riders
- Imported from Japan
- Sold in 32 oz. bottles

DESC	PART #
12 oz, Sold Each	STA5120
12 oz, Sold Each	STA5120



Starbrite® STARTRON



STAR TRON SEF ENZYME FUEL TREATMENT

DESC	QTY/CS	MFG#	PART #
8 fluid oz Sold Each	6	14308	904500
SHOOTER 1 fluid oz. sold each	24	14324	904684
MINI DISPLAY 8 fluid oz. Display (6)	1	14616	904501
COUNTER DISPLAY 8 fluid oz. Display (24)	1	14625	904685
FLOOR DISPLAY 8 fluid oz. Display (48)	1	14649	904686

- Makes all engines start easily, run smoothly; improves performance
- Removes and prevents gum, carbon and varnish
- Works in all engines and in all fuel
- Helps prevent phase separation by dispersing water throughout fuel as submicron-sized droplets that are safely eliminated while the engine operates
- Stabilizes fuel for up to 2 years; helps rejuvenate old fuel
- 1 fl. oz. treats 6 gallons of fuel (8oz. bottle treats up to 48 gallons)
- Reduces smoke and all other emissions
- Keeps fuel delivery system clean
- Overdosing not harmful



STAR TRON SEF ENZYME FUEL TREATMENT

- Engineered to remove tough deposits in fuel systems
- Cleans Injectors, carburetors, fuel pumps, valves & rings
- Simple to use; add to fuel and run engine
- Combines Star Tron enzymes with powerful cleaning agents
- Treats up to 40 gallons

DESC	QTY/CS	MFG#	PART #
Fuel System & Injector Cleaner 4 oz	6	96604	904699



STAR-COOL PREMIUM SYNTHETIC PG ENGINE COOLANT

MAXIMIZES HORSEPOWER SUPER-EXTENDED SERVICE LIFE

- Revolutionary PCT additive package maintains engine temperature to develop maximum horsepower
- Reduces operating temperatures faster than other coolants
- Meets or exceeds all OEM and appropriate ASTM specs
- Formulated to seal pinhole leaks or fissures
- Non-toxic propylene glycol formula will not clog radiators
- Ideal for year-round use; Protects against boilover to 265°F and freezing down to -26°F
- Compatible with all other coolants; can be used to top off or as a flush & fill
- Packaging is legal in all 50 states

DESC	QTY/CS	MFG#	PART #
HI-PERF Extended Life Pg Coolant - 50/50 64 oz	4	33264	904681



ULTIMATE CORROSION BLOCKER

- Creates an invisible, non-sticky barrier against corrosion
- Non-aerosol formula is safe for all painted, chromed and bare metal surfaces
- PTFE® polymers bond to treated surfaces to help repel moisture, dirt, grime and more
- Easy to use; spray on and let dry
- Ideal for protecting bikes as well as cars, trucks, tools, trailers and all other metal surfaces

DESC	QTY/CS	MFG#	PART #
ULTIMATE Corrosion Blocker 22 oz	6	95422	904697



ULTIMATE CITRUS CLEANER & DEGREASER

- Uses the power of citrus to remove the toughest grime, dirt, fish blood, grease stains and more
- Biodegradable formula works on all surfaces
- Removes gummy residue from decals
- Begins breaking up stains on contact
- Ideal for boat, home & garage use

DESC	QTY/CS	MFG#	PART #
ULTIMATE Citrus Cleaner & Degreaser 32 oz.	6	96432	904698



MICROFIBER REGGAE WASH MITT

- The fastest way to remove stains, scuffs and streaks from fiberglass and vinyl surfaces.
- Use wet for washing, dry for dusting
 - Machine washable

DESC	QTY/CS	MFG#	PART #
Microfiber Reggae Wash Mitt	12	40105	904706



ULTIMATE MAGIC SPONGE XL

- The fastest way to remove stains, scuffs and streaks from fiberglass and vinyl surfaces.
- For home, auto, Rv, boat & more
 - Instantly erases dirt, grime, scuff marks and streaks
 - Removes scuffs and stains from vinyl, plastic and fiberglass
 - Ideal for walls, appliances, baseboards, showers, tubs and tiles

DESC	QTY/CS	MFG#	PART #
Magic Sponge XL	8	41008	904709
Magic Sponge	18	41018	904708



STAR BRITE SALT OFF CONCENTRATE

PTEF (Protective Polymer Barrier Coating)

- Removes salt deposits from all marine surfaces
- Use as a motor flush in I/O and outboard engines
- Rinses away salt buildup on hulls, decks, rails, towers, diving equipment, rods, reels and more
- Wash away roadsalt on trailers and equipment used in winter weather.

DESC	QTY/CS	MFG#	PART #
SALT OFF Protector with Ptef Gal.	4	93900	904693
SALT OFF Protector with Ptef 22 Oz.	12	93922	904694
SALT OFF Protector with Ptef Concentrate 32 oz	12	93932	904695
SALT OFF Protector Kit with Ptef 32 Oz w/Applicator	6	94000	904696

Salt Off[®] Concentrate is specifically formulated to quickly and effectively remove salt deposits from metal, fiberglass, plastic or painted surfaces. It contains special polymers that bond to the treated surface to help prevent the formation of future deposits. Depending on the application, Salt Off[®] can be sprayed directly onto the surface to be treated and then rinsed with fresh water, or simply left in place.

The formula is safe for use on all boats, vehicles, trailers, marine parts, engines, fishing and dive gear and more. It will not etch, stain or otherwise damage metal or plastic surfaces. It is ideal for removing salt water deposits from boats and fishing gear, as well as for protecting cars or trailers from the damage caused by exposure to road salt.

Salt Off[®] is also very effective at protecting marine engines used in salt water; when used with the Salt Off[®] Applicator, it will flush deposits from the engine's cooling system to help insure maximum performance and service life. The Applicator can also be used to more easily apply Salt Off[®] to large areas.

Salt Off[®] is available in convenient, Ready to Use, 22 ounce spray bottles as well as in concentrated form, in 32 ounce and 1-gallon containers.

**Removes Salt Deposits
& Leaves a Protective
PTFE Coating**



ULTIMATE XTREME CLEAN



- New gallon size for easy refill of 22 fl. oz. spray container
- Removes even the toughest dirt and greasy stains, even on tough-to-clean porous surfaces
- Special chelating agents break the bond that holds dirt or stains to surface without heavy scrubbing
- Cleans fiberglass, vinyl, plastic, metal and even inflatable boats
- Phosphate-free, safe for use on or near the water; runoff won't harm sealife or cause algae blooms

DESC	QTY/CS	MFG#	PART #
ULTIMATE Xtreme Clean Gallon	4	83200	904688
ULTIMATE Xtreme Clean 22 oz bottle	6	83222	904689

Starbrite's ULTIMATE XTREME CLEAN is formulated with the latest technology ingredients to be the toughest crud-buster ever. The special chelating agents attack road grime, bug bits, bird deposits, greasy smears and more, breaking the bond that holds them to the surface so they can be wiped away without heavy scrubbing. However, unlike most all-

surface cleaners that use cheap, harsh ingredients, Xtreme Clean does not contain caustic, dangerous chemicals that can damage the finish. Xtreme Clean is safe for use on all metal, fiberglass, plastic, chrome, stainless, wrapped, leather and rubber surfaces.



ULTIMATE BIKE GUARD

PROFESSIONAL GRADE

- Spray on, wipe off to enhance the shine of painted surfaces and polished metals
- Protective polymers bond to surface to help repel dirt and UV damage
- Safe for all clearcoats, wraps and metalflake paints on bikes and helmets (avoid overspray onto visors)
- A waterless cleaner that removes light road grime, bug debris, greasy fingerprints and more
- For tough stains and road grime, use ULTIMATE Xtreme Clean cleaner & degreaser as Step 1 in detailing the bike

DESC	QTY/CS	MFG#	PART #
ULTIMATE Bike Guard 22 Oz Spray	6	98022	904702



ULTIMATE WATER SPOT REMOVER

- Safe for use on all painted, plastic, fiberglass and polished metal surfaces
- Spray on & wipe off to remove spots and add shine
- PTEF® polymers help repel future deposits and protect against damaging UV rays
- The easiest way to remove unsightly water spots

DESC	QTY/CS	MFG#	PART #
Water Spot Remover 22 oz	6	92022	904692



ULTIMATE FABRIC GUARD

- Helps restore water repelling action
- Helps block UV rays that cause fading & weathering
- Won't affect color, feel or breathability
- For use on all outdoor fabrics

DESC	QTY/CS	MFG#	PART #
Fabric Guard 32 Oz Spray	6	97532	904701



ULTIMATE MATTE FINISH DETAILER & PROTECTANT

- Specifically formulated to enhance matte, denim, flat, satin and other non-glossy finishes
- Protective polymers bond to treated surface to help repel dirt and UV damage
- Removes road grime, dirt, greasy smudges, bug debris and more
- Safe for all metal, plastic, wrapped and painted surfaces

DESC	QTY/CS	MFG#	PART #
Ultimate Matte Finish Detailer & Protectant 22 Oz.	6	98122	904703



ULTIMATE LUBRICATING FLUID WITH CERFLON®

- Can be applied to all metal parts to prevent grass, dirt, hay, snow, ice, dirt and more from adhering
- Ideal for use on agricultural equipment such as bush hogs and cultivators as well as snow blowers, hedge trimmers, tools, fishing gear, firearms, motorcycles, ATVs, snowmobiles, cars, outboard engines and more
- Forms a micro-thin film that “seals” the treated surface for long-lasting lubrication and protection against corrosion
- CERFLON® nanoparticles bond to treated surfaces for long-lasting lubricity of all metal moving parts
- Deep-penetrates to loosen frozen bolts; displaces moisture; prevents further corrosion of rusted surfaces
- Trigger spray version is solvent-free

DESC	QTY/CS	MFG#	PART #
Ultimate Lubricating Fluid Aerosol 11.75 Oz	12	98212	904704



CHROME & STAINLESS POLISH

- Cleans and shines all chrome and stainless steel surfaces in one easy step.
- Protects against pitting, discoloration, staining and/or rusting.
- Easy to use. Wipe on, wipe off formula.
- Resists salt and water spray.
- Bonds to metal for long lasting protection.
- Also good for copper, tin and brass.
- Leaves a dazzling shine.
- Quickly removes surface corrosion
- Provides a barrier to future stains and corrosion
- Removes dirt, grime, salt deposits, surface rust
- No hard buffing needed to clean surface

DESC	QTY/CS	MFG#	PART #
Chrome & Stainless Polish 8 oz	12	82708	904687



SNAP & ZIPPER LUBRICANT

- Apply to boat snaps, metal and plastic zippers to protect against corrosion, reduce wear and friction, prevent binding and repel salt spray deposits
- Non-toxic, non-staining
- Will not wash off

DESC	QTY/CS	MFG#	PART #
SNAP & ZIPPER Lubricant 1.75 oz	12	89102	904691

ThreeBond



RTV SEALANT - GRAY

- RTV sealant (gray) high viscosity gasket maker.
- OEM specified product
- Good elasticity
- Temperature, chemical, oil, water, coolant, and gasoline resistant
- Excellent as a general purpose LGM
- High resistance to heat and cold
- Sold each

DESC	QTY/CS	MFG#	PART #
3.8 oz	6	TB1200GAU3Z	414000



GASKET MAKER - GRAY

- High viscosity FIPG (form-in-place-gasket) gasket-maker
- OEM specified product
- Good adhesion properties in power-train and small engine applications
- Allows immediate service after application
- Non-slumping formulation 'holds-in-place'
- High resistance to engine and gear oil
- FIPG properties allow for greater 'gap' fill
- Sold each

DESC	QTY/CS	MFG#	PART #
5.3 oz	6	TB1217H	414001



GASKET MAKER - BLACK

- High performance
- High viscosity
- High temp resistance
- High adhesion.
- High torque endurance
- High vibration endurance
- Liquid gasket maker used on more than 5 Million engines
- Non-slumping paste
- Highly effective In continuous vibrating conditions
- Good adhesion to plastic
- Sold each

DESC	QTY/CS	MFG#	PART #
3.5 oz	12	TB4207B	414002



SUPER GLUE

- ThreeBond Super Glue attains practical use strength in a matter of seconds
- Contains no evaporative elements, so there's never any shrinkage to weaken bonding points
- Excellent for non-porous materials
- Sold each

DESC	QTY/CS	MFG#	PART #
2 Grams	36	1742BT020	TB1720



LIQUID GASKET

- Excellent padding properties make this semi-drying, visco-elastic sealer the perfect product for sealing joint surfaces with large clearance
- Special synthetic rubber provides excellent cushion to absorb vibrations and impacts without failure, esp. where coolants are involved
- O.E. motorcycle manufacturers have successfully used this high reliability liquid gasket in numerous applications
- Comes in 3.5 oz. tubes
- Sold each

DESC	QTY/CS	MFG#	PART #
3.5 oz	24	1194A100GA	TB1184



SILICONE LIQUID GASKET

- ThreeBond 1211 Silicone Liquid Gasket is a tough durable sealer utilizing silicone rubber as a primary component
- White in color, its solventless, semi-drying and visco-elastic properties make it ideal for numerous applications where a long lasting, faultless seal is absolutely critical; as it comes in contact with air, it forms a rubberized, elastic mass impervious to vibrations and impacts
- Can be applied to flange surfaces and screw sections to prevent water, oil, gasoline and chemical leaks
- 100% effective over a wide temperature range - 760 to 4820 F. Tack-free in 90 minutes; fully cured and bonded within 24 hours; attains optimum strength in three days
- Recommended for: motorcycle, personal watercraft, ATV engines
- Sold each

DESC	QTY/CS	MFG#	PART #
3.5 oz	6	1211AT100	TB1211



SYNTHETIC RUBBER ADHESIVE

- ThreeBond 1521 is a contact cement which is a multi-purpose, rubber based adhesive that gives excellent bonding characteristics to a wide variety of materials including rubber, plastic, vinyl, metal, leather, woods, ceramics and more
- Provides a strong, waterproof bond and sets up within 5-10 minutes depending on temperature and humidity
- Sold each

DESC	QTY/CS	MFG#	PART #
75 Grams	12	7731521A75G	414004

RTV SEALANT GRAY, LOW VISCOSITY, SOLVENTLESS



- High performance gasket maker
- Excellent heat/chemical and gear oil resistance
- Sold each

DESC	QTY/CS	MFG#	PART #
8.8 oz	6	TB1215	414003

GRIPLOCK



- A high adhesive specially formulated to keep grips in place without damaging the rubber
- Griplock puts an end to grips twisting or sliding off
- Ideal for motorcycle, personal watercraft, snowmobiles and ATVs
- Sold each

DESC	QTY/CS	MFG#	PART #
1 oz	12	1501CT100	TB1501
10 Grams	24	1501CT102	TB1505

HI STRENGTH RETAINING



ThreeBond's High strength retaining properties for various threads, screws, bolts, piping joints, gears, pulleys and fans which are not frequently removed or must remain secure for safety and/or structural integrity reasons. Sold each.

DESC	QTY/CS	MFG#	PART #
10 ml	6	1303AT000	TB1303
50 ml	12	1303A50C	TB2303

LOW STRENGTH/ FREQUENT REPAIR



- ThreeBond's Low Strength Frequent Repair product is perfect for small screws and bolts which are frequently removed and require a force of only 10-20% greater than that used for tightening. Sold each.

DESC	QTY/CS	MFG#	PART #
10 ml	6	1342AT002	TB1342
50 ml	12	1342A50C	TB2342



BEARING AND STUD LOCK

ThreeBond's Bearing & Stud Lock includes high strength retaining properties for bearings and studs which are not frequently removed and must remain secure for safety or structural integrity reasons. Sold each.

DESC	QTY/CS	MFG#	PART #
10 ml	6	1333BT001	TB1333
50 ml	12	1333B50C	TB2333



HI TEMPERATURE

- ThreeBond's Hi Temperature Thread Lock is a new sealing and locking agent made to withstand extreme temperatures without weakening. Incorporates various strengths of anaerobic locking agents which makes it ideal for sealing engine and exhaust components. Sold each.

DESC	QTY/CS	MFG#	PART #
10 ml	6	1360AT003	TB1360
50 ml	12	1360A50C	TB2360

ThreeBond

SEALANTS and GASKET MAKERS





ORM-D
GROUND ONLY
This product cannot be shipped by Air.



SYSTEM MAINTENANCE KIT

- Keep your Twin Air Filter in top condition
- Kit includes exclusive Liquid Power filter oil (1 Lt) and Dirt Remover filter cleaner (1 Lt) plus a cleaning tub (with cage), oiling tub, contact cleaner and gloves
- Liquid Power filter oil also available separately in a hand 500 ml spray can
- Also available with Bio Filter care products

DESC	MFG#	PART #
Maintenance Kit	159000	630838

ORM-D
GROUND ONLY
This product cannot be shipped by Air.



OILS AND CLEANERS

- The original formula that sets the standard of excellence in our filter oils
- Starts thin for even distribution, then turns super tacky to trap dirt, grit and dust
- Dirt remover, removes all oil for easy clean up

DESC	MFG#	PART #
Contact Cleaner (500 ml)	159003	630840
Power Filter Oil (1 Lt)	159015	630847
Dirt Remover Filter Cleaner	159002	630839
Dirt Remover Spray (500 ml)	159006	630842
Dirt Remover and Oil Kit	159007	630843
Filter Oil Spray (500 ml)	159016M	630848

OILING TUB



Submerge your clean filter in this tub for easy even oiling. Then massage out the excess oil and reseal to store your unused filter oil. Filter Oil sold separately.

DESC	MFG#	PART #
Oiling Tub	159010	630844

CLEANING TUB



This resealable tub comes with a filter tray that allows dirt to sink to the bottom away from your filter. Filter cleaner sold separately.

DESC	MFG#	PART #
Cleaning Tub	159011	630845
Replacement Cleaning Cage	159013	630846



BIO OILS AND CLEANERS

- Bio oils and cleaners are formulated for superior performance and to be friendly to our environment
- Easy clean up in your washing machine or sink

DESC	MFG#	PART #
BIO Dirt Remover (1 lt)	159004	630841
Liquid BIO Power (1 lt)	159017	630849
BIO Pack - Bio Dirt Remover and Liquid BIO Power Oil	159020	630851
BIO Power Spray (500 ml)	159018M	630850
BIO System (Complete Air Filter Maintenance)	159017	630849

BIO OIL & CLEANER MAINTENANCE

Full filter biodegradable care solution includes everything you need in a sturdy storage box with handles. Kit Includes: Twin Air cleaning tub with cage Oiling tub BIO dirt cleaner BIO Liquid power filter oil Contact cleaner Rubber gloves

DESC	MFG#	PART #
Filter System Care	15900BIO	631854



TWIN AIR FOAMING POWERWASH

Twin Air Foaming PowerWash is a deep-penetrating, biodegradable powerhouse formulated to cut through grime, grit and grease throughout your garage, workshop and home.

DESC	MFG#	PART #
Powerwash	159050	632136



BIO AIR FILTER SEALANT

Waterproof and resistant to dust and dirt, Twin Air Bio Sealant, unlike air filter grease, does not dissolve at high temperatures and does not harden in extreme cold. Twin Air Bio Sealant ensures excellent sealing even when used with oiled air filters.

DESC	MFG#	PART #
Air Filter Sealant	159030	631865



HEAVY DUTY WET POWER WIPES

Use these durable, damp, highly absorbent wipes to take on—bare-handed—heavy industrial grime including oil, grease, paints, glues, varnishes and sealants. They work without solvents, smell like eucalyptus, and don't leave a sticky feeling. Tough on grime, gentle on hands.

DESC	MFG#	PART #
Wet power wipes	159055	632138

ICEFLOW HIGH PERFORMANCE COOLANT

This ready-to-use coolant provides long lasting protection of all metals inside today's liquid-cooled systems, without harming the water pump seals. It reduces and maintains the operating temperature to prevent over-heating, offers the added assurance of an extreme freezing point (-26°C / -14.8°F) and boosts reliability.

DESC	MFG#	PART #
Engine Coolant 2.2L	159040	631867





**UNI FOAM FILTER CLEANER
AEROSOL (16 OZ)**

Designed to be used on all OEM and performance foam air filters• Resists dripping and drain-off• Formulated to trap dirt particles and will not affect the air flow when properly applied

DESC	QTY/CS	MFG#	PART #
16 oz	6	UFC-300	UFC300



**UNI FOAM FILTER OIL
AEROSOL (5.5 OZ)**

Designed to be used on all OEM and performance foam air filters• Resists dripping and drain-off• Formulated to trap dirt particles and will not affect the air flow when properly applied

DESC	QTY/CS	MFG#	PART #
5.5 oz	6	UFF-100	UFF100



**UNI FOAM FILTER OIL LIQUID
(16 OZ)**

Helps trap dirt particles for better filtration
Excellent for original equipment and replacement air filters

DESC	QTY/CS	MFG#	PART #
16 oz	6	UFF-16	UFF16



**UNI FOAM FILTER SERVICE KIT
(CLEANER & OIL)**

Uni Filters deliver top-tier performance and superior filtration, even in extreme conditions, thanks to their dual-layer design. For maximum protection and airflow, always use UNI Foam Filter Oil and Cleaner specially formulated to maintain filter performance and extend engine life. Trusted by pro racers for decades.

DESC	QTY/CS	MFG#	PART #
5.5 oz	6	UFF-100	UFF100



TABLE OF CONTENTS

ALL BALLS	298
BEADBUSTER	299
BRONCO	300-301
CALIBER TRAILER	302-303
COUNTERACT	304-305
DAPCO	305
EMGO	306-307
EPI PERFORMANCE	308-309
HELIX	310-312
HOTCAMS	313-314
KIBBLEWHITE	315
KLUBER LUBRICATION	316
SNOW STUFF	317
MAXIMA	318
MOTIONPRO	319-366
MOTORSPORT	367-369
PERFORMANCE TOOL	370-405
POLISPORTS	406
PSYCHIC.....	407
RATIO RITE	408
RISK	409-413
RM STATOR	414-416
SPI	417-419
SLP	420
SUSPA	421
TERAPUMP	422-423
VP RACING	424-426
WOODYS	427-428



ALL BALLS BATTERY ISOLATOR KIT



- Automatically isolates secondary auxiliary battery from primary battery for running accessories
- Prevents primary battery from draining when vehicle is stopped while maintaining a charge in both batteries when vehicle is running
- Kit includes battery isolator module, wiring kit, mounting hardware

138608



ALL BALLS BATTERY CABLE CRIMPING TOOL

- CRIMPS 16 TO 4 GAUGE WIRES (USED WITH HAMMER OR VICE)

132250



BeadBuster



873000

BEADBUSTER XB-455 TIRE BEAD BREAKER ATV/UTV

- Up for sale is BEADBUSTER XB-455 TIRE BEAD BREAKER ATV/UTV. The vender part number is BB4. Please read title carefully to know what you are getting and here is the catalog description?
 - The quality of this tool is exceptional, BeadBuster works to maintain strict quality control, to ensure a final product that will deliver years of reliable use. With the home mechanic and trail rider in mind, it was specifically designed for difficult-to-remove ATV tires, but we soon realized that it worked just as well on just about every kind of tire there is including motorcycle tires. No adjustment is needed for different tire/wheel sizes. It is small, portable, and perfect for stashing in your glove box or toolbox.
 - Save time, money, and frustration by quickly and easily changing your own tires whenever, and wherever you want.
- ATVs, UTVs
 - Motorcycles: Street & Dirt, Scooters
 - Cars: Passenger & Race Cars (ie. Sprint, Dirt Track)
 - Trucks, 4x4s, Jeeps
 - Trailers
 - Lawn Mowers, Garden Tractors Go Karts,
 - 1/4 Midgets
 - Light Aircraft

BeadBuster

BRONCO®

ATV & UTV COMPONENTS

BRONCO CV BOOT BANDING TOOL



- CV Boot installation made easy with the one tool
- This new banding tool will tighten bands and cut, making installation fast and easy
- Made from high quality steel
- Black powder coated with red PVC handles

120036

BRONCO CV BOOT CLAMP PLIERS



- CV Boot Clamp Pliers for low profile flat clamps manufactured from steel. Black powder coat with red handles.

120037

BRONCO CV BOOT BANDING TOOL, RATCHET TYPE



- Ratchet style allows maximum tension.

121974

BRONCO CV BOOT CLAMP KIT W/TOOL



- Clamp: 25mm x 254mm x 2 pieces; 6.3mm x 482mm x 2 pieces
Banding tool (AT-08520A) x 1 piece with instruction sheet
Stainless steel 430

121975

BRONCO S.S. CV BOOT CLAMP 10"



- UNIVERSAL CV BOOT CLAMP. Used to replace missing clamps or to re-clamp boot after CV Joint service work. Available in two different lengths.

121977

BRONCO CV BOOT GREASE PACK



- CV BOOT GREASE PACK

121978



**BRONCO 16 PACK HOSE BENDER
1" O.D. HOSE**

- Length: 119.2mm. Width: 31.5mm. Fit O.D. 1" fuel line. Material: abs

128662



**BRONCO CYLINDER HONING
BRUSH**

A Bronco Cylinder Honing Brush is a tool used to finish the surface of engine cylinders, typically after boring or other machining processes. It is a flexible honing tool, resembling a bottle brush with abrasive spheres at the end of each bristle. The honing process creates a cross-hatched pattern on the cylinder wall, which helps with lubrication and proper piston ring seating.

SIZES	PART #
FIT 45-57 MM	999781
FIT 57-70 MM	999782
FIT 63-76 MM	999783
FIT 76-89 MM	999784
FIT 89-102 MM	999785



BRONCO
ATV & UTV COMPONENTS



**CALIBER FLEX & FOLD FUNNEL - 3
PC. BUNDLE SMALL, MEDIUM &
LARGE**



- Fold-flat innovation allows your funnel to easily fit in vehicles and toolboxes
- Flexible material conforms for hard-to-reach areas
- Magnets keep the funnels closed and the fluids inside
- Safe for all powersports and motorsports fluids
- Used for a variety of applications: DEF Fluid, Brake Fluid, Coolant, Fuel, Wiper Fluid, and more
- This Masterpack includes one of each size: Small, Medium, Large.

362100

**CALIBER FLEX & FOLD FUNNEL -
SMALL - BLUE**



- Fold-flat innovation allows your funnel to easily fit in vehicles and toolboxes
- Flexible material conforms for hard-to-reach areas
- Magnets keep the funnels closed and the fluids inside
- Safe for all powersports and motorsports fluids
- Used for a variety of applications: DEF Fluid, Brake Fluid, Coolant, Fuel, Wiper Fluid, and more

362101

**CALIBER FLEX & FOLD FUNNEL -
MEDIUM - YELLOW**



- Fold-flat innovation allows your funnel to easily fit in vehicles and toolboxes
- Flexible material conforms for hard-to-reach areas
- Magnets keep the funnels closed and the fluids inside
- Safe for all powersports and motorsports fluids
- Used for a variety of applications: DEF Fluid, Brake Fluid, Coolant, Fuel, Wiper Fluid, and more

362102

**CALIBER FLEX & FOLD FUNNEL -
LARGE - PURPLE**



- Fold-flat innovation allows your funnel to easily fit in vehicles and toolboxes
- Flexible material conforms for hard-to-reach areas
- Magnets keep the funnels closed and the fluids inside
- Safe for all powersports and motorsports fluids
- Used for a variety of applications: DEF Fluid, Brake Fluid, Coolant, Fuel, Wiper Fluid, and more

362103



CALIBER SCREW PACK MULTI GRIP PACKAGE - 33/PACK

- Screw Pack Multi Grip Package
- Pack of 33

362098



CALIBER SCREW PACK MULTI GRIP - 8/PACK

- CALIBER MULTI GLIDES STAINLESS STEEL FASTENERS. Each 5' section requires one screw pack. Package of 8.

PD0103

CALIBER PIVOT PRO UNIVERSAL DOLLY



- Multi-faceted design provides solutions for multiple vehicle types
- When placed under the track of a snowmobile the PivotPro becomes the perfect companion to Caliber SledWheels – providing 360 deg. rotational ability for shops and garages
- Designed notches allow you to place this dolly under your snowmobile skis
- With a 500lb. capacity – and a set of four – you can utilize the incorporated dish to provide mobility to both ATVs and UTVs
- With the incorporated recess – and Caliber's TraxSaver – you have a secure storage solution to prevent lug compression of your track in the off-season
- Durable 4" caster wheels provide the ability to move the vehicles on various surface types
- Includes Caliber's Lifetime Warranty

362067



CALIBER SLEDWHEELS - SNOWMOBILE TRANSPORT KIT - 2021

- Provides amazing mobility for snowmobiles.
- Universal modular design works with most all snowmobiles.
- Lifts your carbide and protects from excessive wear.
- Protects your floor and ground surfaces from destruction.
- Innovative design provides fast engagement and disengagement.
- Locking pin keep Sled Wheels attached so you can drive up to speeds of 12 mph.
- Comes with Caliber's lifetime warranty

362070

CALIBER MR20K WHEEL CHOCKS



Caliber Mr20K Red Wheel Chocks 13596 Wheel chocks are a great tool to prevent accidents and keep everyone safe when loading, unloading or servicing your vehicle.

362106

CALIBER ROVER 360 SNOWMOBILE CASTERS



- The Caliber Rover 360 snowmobile casters are designed to provide effortless 360-degree mobility for snowmobiles in garages and shops. They feature 3-inch caster wheels and a center channel that suspends keels up to 2.5 inches deep, minimizing the risk of damage to the skis. Durable rubber dolly pads increase surface contact and grip on the skis, ensuring full control of movement.



QTY	PART #
3 / PACK	362120
2 / PACK	362121



COUNTERACT DIY KITS

- No more external weights!
- Made from micro-glass beads
- Increases tire life, improves fuel economy
- Reduced vibration and heat build up
- Tires are balanced all the time, not just at over 30 mph like other products
- No rebalancing every time you come to a stop
- No dust to clog valve cores
- Guaranteed safe for all tire pressure monitoring systems (TPMS)
- Can be used in tube type and tubeless tires
- Simply throw in a bag when mounting a new tubeless tire or use the DIY kit for “on the bike” and tube type installation



DESCRIPTIONS	PART #
Motorcycle, 2 - 1oz. bags	746100
Motorcycle, one - 1 oz bag, one - 2 oz bag	746101
Motorcycle, one - 1 oz bag, one - 3 oz bag	746102
Motorcycle, two - 2 oz bags	746103
Motorcycle, one - 2 oz bag, one - 3 oz bag	746104
Spyder, two - 2 oz bags, one - 3 oz bag	746105
Trike, one - 2 oz bag, two - 3 oz bags	746106
ATV/UTV, four - 2 oz bags	746107
ATV/UTV, two - 2 oz bags, two - 3 oz bags	746108
ATV/UTV, four - 3 oz bags	746109
ATV/UTV, four - 4oz bags	746110
ATV/UTV, four - 6oz bags	746111
ATV/UTV, four - 8oz bags	746112
ATV/UTV, four - 10oz bags	746113

**DIY kit includes premeasured bead bags, applicator bottle with tube, valve core remover, valve caps and valve cores.

APPLICATION CHART	AMOUNT PER TIRE
MOTORCYCLE	
Front 80mm - 120mm tire width	1 oz
Front 130mm - 240mm tire width	2 oz
Front 240mm & up tire width	3 oz
Rear 130mm - 240mm tire width	2 oz
Rear 250mm - 360mm tire width	3 oz
195 - 205 car tire on rear width	3 oz
SCOOTERS	
Up to 10" rim diameter	1 oz
12" & Up rim diameter	2 oz
DIRT/DUAL SPORT BIKES W/O RIM LOCKS	
Front 80mm - 120mm tire width	1 oz
Rear 130mm - 230mm tire width	2 oz
DIRT/DUAL SPORT BIKES W/RIM LOCKS	
Front 80mm - 120mm tire width	2 oz
Rear 130mm - 230mm tire width	3 oz
TUBE TYPE TIRE, WIRE SPOKE RIM	
80mm - 120mm tire width	2 oz
130mm - 240mm tire width	2 oz
ATV/UTV	
23"-29" tire	4 oz
30"-33" tire	6 oz
33"-37" tire	8 oz
37" and up tire	10 oz



SIZES	PART #
1 oz bags / 20 pk bucket	746097
2 oz bags / 20 pk bucket	746098
3 oz bags / 20 pk bucket	746099

**Shop packs include pre-measured bags, caps and cores

SHOP PACKS

- Enhanced vehicle performance.
- Easy to use application.
- Increases tire life.
- Reduce rolling resistance with centrifugal force, reducing and providing a more even wear across your tire.



1oz

746094



2oz

746095



3oz

746096

COUNTERACT BALANCING BEAD SHOP PACK 4

- No more external weights!
- Made from micro-glass beads
- Increases tire life, improves fuel economy
- Reduced vibration and heat build up
- Tires are balanced all the time, not just at over 30 mph like other products
- No rebalancing every time you come to a stop
- No dust to clog valve cores
- Guaranteed safe for all tire pressure monitoring systems (TPMS)
- Can be used in tube type and tubeless tires
- Simply throw in a bag when mounting a new tubeless tire or use the DIY kit for "on the bike" and tube type installation



DAPCO INDUSTRIES
CARBURETOR LEAK DETECTOR

- Provides a simple method of checking needle and seat pressure as well as impulse diaphragms, etc.

LD1075





EMGO BIT SET (4)



- All items sold individually unless otherwise specified.
- Contains one (1) each of the following bits: #2 & #3 Phillips #8 & #10 Slotted short shank Set of 4

EM03801

**EMGO CUP TYPE OIL FILTER
WRENCH**



- Fits spin on oil filters
- Order by filter diameter or Emgo oil filter number

SIZES	PART #
64.7MM	EM04181
67MM	EM04182

**EMGO FUSE HOLDER WITH 20
AMP FUSE**



- Universal In-line fuse holder. 16 Gauge wire. Bakerlite with 20 amp fuse.

EM93320

EMGO CHAIN BREAKER



- Repair shop chain breaker for 420, 428, 520, 530 and most 630 chains. Screw off handle for easy storage.
- Easy to use

826367

EMGO FILTER WRENCH



- Wafer thin wrench fits easily in tool kits
- Fits many Honda, Kawasaki, Yamaha, and Polaris models

826356

**EMGO PLUG WRENCH (10-12-
14MM)**



- 10mm - 14mm
- 3 way tip to fit all ATV spark plugs
- Chrome finish
- 2-7/8 in. length

EM04100



EMGO T-HANDLE SPARK PLUG WRENCH

- 12mm wrench
- Fits all D size NGK spark plugs
- Zinc plated
- 4-5/8 in. length

EM04110



EMGO IMPACT DRIVER WITH SHORT BIT SET

- Heavy duty design for general shop use
- Tightens or loosens screws or bolts on impact
- Complete with four bits and metal storage case
- 3/8" square drive

824744



EMGO SPOKE WRENCH 6-WAY

- Fits 6 different sizes - 1, 2, 3, 4, 5 and 6
- Durable black finish
- Made of forged steel
- Stock Location 6

826350



EMGO TIRE GAUGE TO 8 PSI (PACKAGE OF 10)

- Emgo low pressure tire gauge
- Pocket sized (2.5") with key ring and chain
- Marked in 1/2 lb. increments
- Accurately measures tire pressure up to 8 lbs.

EM68508



EMGO LOW PRESSURE TIRE GAUGE - 1-20 PSI

- Available in 0-8 psi and 1-20 psi versions

EM68520



EMGO PLUG WRENCH HONDA 89216-MR1-0

- HONDA OEM: 89216-MR1-000
- 18MM 145MM LONG

826343

EPI

PERFORMANCE

EPI WHEEL BEARING GREASER - 40 MM



- High-quality CNC machined with precision-drilled grease channel and dual O-ring seals
- Quick and easy way to extend the life of your wheel bearings
- Simply remove the wheel, brake caliper and hub (also spindle or wheel shaft for models that need 30mm greaser); insert greaser tool and use your grease gun to pack your wheel bearings
- 30mm EZ Greaser is designed to service Can-Am 30mm ID wheel bearings
- 39mm EZ Greaser is designed to service Can-AM 39mm ID wheel bearings with removing the wheel shaft
- 40mm EZ Greaser is designed to service Polaris 40mm ID wheel bearings without removing the wheel shaft
- 44mm EZ Greaser is designed to service Polaris 44mm ID wheel bearings without removing the wheel shaft

378218

EPI WHEEL BEARING GREASER - 44 MM



- Designed to allow servicing of Polaris 44mm ID wheel bearings without removing the wheel shaft
- Works with Polaris bearings 3514822, 3514699, 3514924 & 3514627, EPI bearing WE301438 or any equivalent
- High quality CNC machined with precision drilled grease channel
- Simply remove the wheel, brake caliper and hub. Insert Greaser Tool and use your grease gun to pack your wheel bearings
- Quick and easy way to extend the life of your wheel bearings

378219

EPI WHEEL BEARING GREASER - 30 MM



- Designed to allow servicing of Can-Am 30MM ID wheel bearings
- Works with Can-Am Bearings 293350040 and 293350118, EPI Bearing WE301411 or equivalent
- High quality CNC machined with precision drilled grease channel
- Simply remove the wheel, brake caliper, hub and spindle or the wheel shaft. Insert greaser tool and use your grease gun to pack your wheel bearings
- Quick and easy way to extend the life of your wheel bearings
- This part will not fit over the wheel shaft. On some models the spindle or the wheel shaft will need to be removed to gain access to the bearing

378220

EPI WHEEL BEARING GREASER - 39 MM



- Designed to allow servicing of the Can-Am 39MM ID wheel bearings without removing the wheel shaft
- Works with Can-Am bearing 293350109 and 293350129. EPI Bearing WE301451 or any equivalent
- High quality CNC machined with precision drilled grease channel
- Simply remove the wheel, brake caliper and hub. Insert the greaser tool and use your grease gun to pack your wheel bearings
- Quick and easy way to extend the life of your wheel bearings

378221

EPI CV BOOT CLAMP KIT WITH ECONOMY BANDING TOOL



- Includes 4 clamps and an economy banding tool
- Used to replace missing clamps or to re-clamp boot after CV Joint service work

WE145000

EPI ECONOMY UNIVERSAL CV BOOT BANDING TOOL



- Used to tighten boot clamp
- Sold each

WE145020



EPI PERFORMANCE PISTON PIN PULLER

- Universal Piston Pin Puller easily removes all sizes of piston pins without any damage to pistons
- Includes 2 different size plungers (14mm & 17mm)
- Can also help to prevent bent and damaged rods
- Use in conjunction with our clutch bushing installation tool kit to make clutch rebuilding quicker and easier

378493





HELIX MAGNETIC BOLT TRAY

- Magnetic parts tray, stainless steel, 6" round super strong bowl is handy to keep all the small parts and pieces together for projects so they won't get lost!
- Keeps small parts where you put them.
- Stainless steel

920041



HELIX RADIATOR FIN STRAIGHTENER

- This 6-in-1 handy tool will save a lot of time cleaning radiator and oil cooler fins
- Sections are marked to align proper fin sizes
- Tool is compact to fit in tight spaces, removable handle for even more space in tight spaces
- Straightens fin size 8,9,10,12,14 & 15 fins per inch.

920040



HELIX HEAVY DUTY MUFFLER PACKING

- Helix Racing Heavy Duty Muffler Packing 160-1112 Super high-density needle mat with enough packing to fine tune your exhaust more than once. Increases exhaust back pressure.
- 1,200 Degree F protection
- 1x16x11
- Made in USA

920033



LOW DENSITY MUFFLER PACKING, 1"X11"X16"

- This fluffy low density fiberglass works best with 2 stroke mufflers to control sound and oil residue.

920032



HELIX SCREWDRIVER HANDLE VALVE CORE TOOL

- Screwdriver handle valve stem core extractor, professional quality and perfect size for the shop.

920037



HELIX SPRING PULL TOOL

- Spring pull tool, this lightweight flexible design can reach tight spaces to install and remove extension springs on exhaust systems, kickstands, brake pedals and other extension springs on your machine.

920038

Buy 16 and get a free display



HELIX SAFETY WIRE .032 DIA STAINLESS

.032 Diameter stainless steel safety lock wire, 1/4lb spool, a must for every tool kit, required by most racing organizations to safety wire parts that may come loose or fall off. Also great for repairs on the trail.

920046



HELIX TIRE IRON WITH RIM PROTECTOR - 380MM

Special design with bonded plastic on one side to protect rims from damage. 15" Long, drop forged and zinc plated, tapered and curved ends.

920051



HELIX JET CLEANING TOOL

- Jet cleaning tool to clean clogged jets and passageways inside the carburetor. Kit has ten wire sizes to cover the most common jet sizes. Comes in Helix storage case. Small enough to keep on the bike or in the shop.
- An invaluable tool kit for cleaning carburetor jets and small holes
- Small enough to keep in any toolbox
- Ten pin sizes cover the most common jet sizes

920043



HELIX GASKET SCRAPER TOOL

- Gasket Scraper Tool, 25mm Wide, 280mm Long

920044



HELIX EXHAUST WRAP

- Insulates exhaust pipe on the inside to achieve maximum fuel burn, increase horsepower and improve exhaust flow
- Dampens exhaust sound and protects from contact with hot pipes
- Application of Helix High Temp Exhaust System Paint is recommended to extend the life of the wrap and help retain color



HELIX FOOT PUMP

- Compact foot pump with gauge, folds flat to save space, poor mans compressor can be a life saver when you need some remote air.

920049

DESCRIPTIONS	PART #
Insulating Exhaust Wrap Tan 2"X 25'	920081
Exhaust Wrap Tan 2"x25'	920082

HELIX HEAT SHIELD WITH ADHESIVE



- Aluminized fiberglass heat shield w/adhesive.
- This adhesive material works great where exhaust system and hot engine components come in close contact with plastic body panels.

SIZES	PART #
2" X 3FT	920092
2" X 15FT	920093





HOTCAMS VALVE SHIM 5PK



- Made from 4140 cold rolled steel, Hot Cams shim kits and refill packs make the perfect addition to any toolbox for keeping any valvetrain in perfect working order
- Replacement packs of shims to refill Valve Shim Kits
- Valve shim packs includes five shims of the same size

SIZES	PART #
13 X 2.70	144915
13 X 2.75	144916

HOTCAMS STANDARD CAM-SHAFT INSTALLATION KIT



- STANDARD CAMSHAFT INSTALLATION KIT
- Contains degree wheel, standard unit indicator, adjustable magnetic stand and three positive stops (10mm, 12mm and 14mm threads)
- Can be used to install and adjust timing of any cam
- Comes with wooden carrying case

870818

HOTCAMS VALVE SHIMS



HOTCAMS VALVE SHIMS CONTINUED

7.48mm		8.90mm		9.48mm		10.00mm		13.00mm	
SIZES	PART #	SIZE	PART #	SIZES	PART #	SIZES	PART #	SIZES	PART #
1.20mm	870848	1.72mm	870895	1.20mm	870918	1.85MM	870820	1.85mm	871041
1.25mm	870849	1.80mm	870897	1.25mm	870919	1.90MM	870821	1.90mm	871042
1.30mm	870850	1.84mm	870898	1.30mm	870920	1.95MM	870822	1.95mm	871043
1.35mm	870851	1.88mm	870899	1.35mm	870921	2.00MM	870823	2.00mm	871044
1.40mm	870852	1.92mm	870900	1.40mm	870922	2.05MM	870824	2.10mm	871046
1.45mm	870853	1.96mm	870901	1.45mm	870923	2.15MM	870826	2.15mm	871047
1.50mm	870854	2.00mm	870902	1.50mm	870924	2.20MM	870827	2.20mm	871048
1.55mm	870855	2.04mm	870903	1.55mm	870925	2.25MM	870828	2.25mm	871049
1.60mm	870856	2.08mm	870904	1.60mm	870926	2.30MM	870829	2.30mm	871050
1.65mm	870857	2.12mm	870905	1.65mm	870927	2.35MM	870830	2.35mm	871051
1.70mm	870858	2.16mm	870906	1.70mm	870928	2.40MM	870831	2.40mm	871052
1.75mm	870859	2.20mm	870907	1.75mm	870929	2.45MM	870832	2.45mm	871053
1.80mm	870860	2.24mm	870908	1.80mm	870930	2.50MM	870833	2.50mm	871054
1.85mm	870861	2.32mm	870910	1.85mm	870931	2.55MM	870834	2.55mm	871055
1.90mm	870862	2.36mm	870911	1.90mm	870932	2.60MM	870835	2.65mm	871057
1.95mm	870863	2.40mm	870912	1.95mm	870933	2.65MM	870836	2.80mm	871060
2.00mm	870864	2.44mm	870913	2.00mm	870934	2.70MM	870837	2.85mm	871061
2.05mm	870865	2.52mm	870915	2.05mm	870935	2.75MM	870838	2.90mm	871062
2.10mm	870866	2.60mm	870917	2.10mm	870936	2.80MM	870839	2.95mm	871063
2.15mm	870867			2.15mm	870937	2.85MM	870840	3.00mm	871064
2.20mm	870868			2.20mm	870938	2.90MM	870841	3.05mm	871065
2.25mm	870869			2.25mm	870939	2.95MM	870842	3.10mm	871066
2.30mm	870870			2.30mm	870940	3.00MM	870843	3.15mm	871067
2.35mm	870871			2.35mm	870941	3.05MM	870844	3.20mm	871068
2.40mm	870872			2.40mm	870942	3.15MM	870846		
2.45mm	870873			2.45mm	870943	3.20MM	870847		
2.50mm	870874			2.50mm	870944	3.25mm	871040		
2.55mm	870875			2.55mm	870945				
2.60mm	870876			2.60mm	870946				
2.65mm	870877			2.65mm	870947				
2.70mm	870878			2.70mm	870948				
2.75mm	870879			2.75mm	870949				
2.80mm	870880			2.80mm	870950				
2.85mm	870881			2.85mm	870951				
2.90mm	870882			2.90mm	870952				
2.95mm	870883			2.95mm	870953				
3.00mm	870884			3.00mm	870954				
3.05mm	870885			3.05mm	870955				
3.10mm	870886			3.10mm	870956				
3.15mm	870887			3.15mm	870957				
3.20mm	870888			3.20mm	870958				
3.25mm	870889			3.25mm	870959				
3.30mm	870890			3.30mm	870960				
3.40mm	870892			3.40mm	870962				
3.45mm	870893			3.45mm	870963				
3.50mm	870894			3.50mm	870964				



**KPMI VALVE GUIDE BALL HONE
TOOL**



- Kibblewhite Precision Machining (KPMI) offers valve guide hones, including their Flex-Hone tools, designed to size and finish valve guides in cylinder heads, particularly those made of C630 nickel bronze. These hones are used to create a cross-hatch finish, which improves oil retention and reduces wear on the valve stem and guide. KPMI also provides carbide reamers for sizing valve guides, including manganese guides.
- Sold each
- Made in the U.S.A.

SIZES	PART #
4mm up to 3/8in	960277
4.00mm	961303
4.50mm	961304
5.00mm	961305
6.00mm	961308
7.00mm	961309
5/16	961316
9.50mm	961320

KPMI VALVE GUIDE REAMER



- High speed steel
- These reamers have been specifically designed for KPMI Manganese Bronze and Cast Iron valve guides
- Also, once a reamer is used on Cast Iron, it is not advisable to then use it on a bronze guide

SIZES	PART #
HHS, 0.2357	961307
HHS, 0.2770	961310
HHS, 0.3100	961312
HHS, 0.3115	961314
HHS, 0.3400	961317
HHS, 0.3410	961318
HHS, 0.3730	961319
HHS, 0.3770	961321
HHS, 0.3775	961322
HHS, 0.3780	961323
HHS, 0.3790	961324

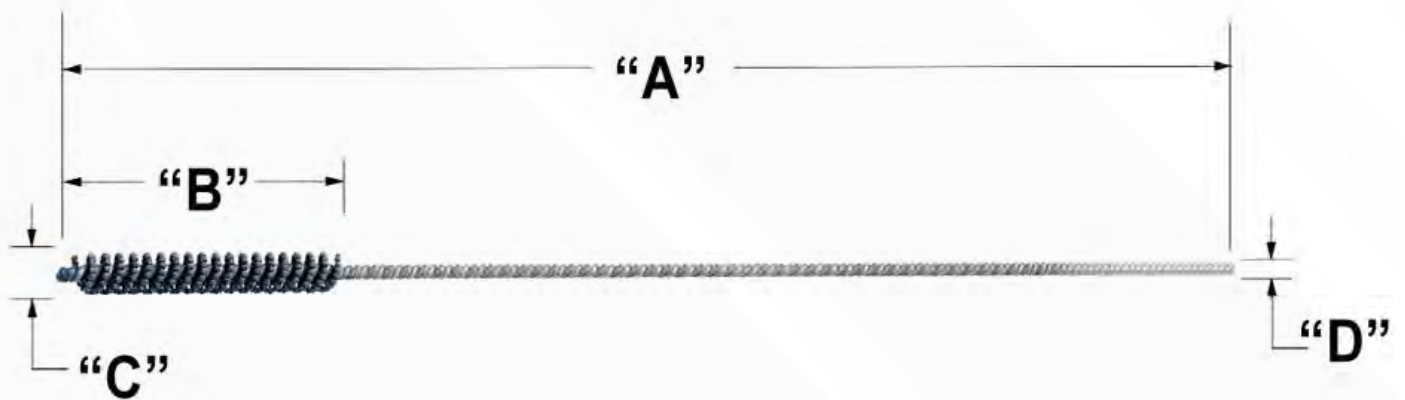

KLÜBER LUBRICATION



KLUBER ISO FLEX GREASE TOPAS NB52 (50 GRAMS)

- Klüber Isoflex Topas NB 52 is a lubricating grease with a wide service temperature range for plain and rolling bearings
- Klüber ISOFLEX TOPAS NB 52 is the grease specified by manufacturers such as Bombardier and Ski-Doo and include applications such as engine bearings in snowmobiles and one-way clutches in ATV
- Designed for long term lubrication of ball and roller bearings and plain bearings
- Consists of a synthetic hydrocarbon oil and barium complex soap
- Wide temperature range -60Å° to 250Å° F
- Suitable for low temperaturesÅ
- Resistant to water and ambient media
- Good corrosion protection
- Resistance to oxidation and ageing
- Good pressure absorption
- Speeds up to 850,000 dN
- 1.76 ounce tube

989001

KLÜBER LUBRICATION



SNO STUFF

KORONIS SNO STUFF DELUXE SPRING TOOL



- Exhaust spring hook tool
- Designed to remove/ install exhaust springs
- Made from tough 3/8in. steel rod
- Available as a single tool or in a five-piece kit
- Single tool measures 12in. long with a 20 degree ergonomic bend

214091

KORONIS SNO STUFF DELUXE SPRING TOOL MULTI-PACK



- Contains a selection of exhaust spring hook tools
- Includes: 10 1/2" curved tool with perpendicular hook; 12 1/4" angled tool with parallel hook; 9 3/4" straight tool with parallel hook; 5 1/2" straight tool with parallel hook; and 5 1/2" straight tool with perpendicular hook

214092





MAXIMA QUICK 2 MIX BOTTLE

- The Maxima Quick 2 Mix™ bottle has been calibrated to give you the ability to accurately mix in ratios of 24:1 to 100:1. Mixes ounces/cc's; gallons/liters. Simply choose the ratio of oil you wish to use and the amount of gas you are going to mix. Fill oil to the mark corresponding to the amount of gas you will use. Also features ounce and CC calibrations—located on the right side. Use these for your own custom ratios, filling transmission oil, fork oil, etc. For example: To mix 4 gallons of gas at 32:1, fill oil to the 4.0 gallon mark under 32:1 ratio. To mix 6 gallons of gas at 50:1, fill oil to 6.0 gallon mark under 50:1 ratio. etc. . . . If you are using liters of gas, follow the same procedure. Convenient cap keeps inside clean. Durable polypropylene. Easy to measure. Compact size.
- Oil/gas ratio mixing bottle
- Easy calibration - accurately mix ratios 24:1 to 100:1
- Durable polypropylene - accurate, convenient, easy, compact

930070





**MOTION PRO STANDARD STEEL
TIRE IRONS**

- Cold forged steel
- Tire iron fit in tool bag or tool pack
- Easy to use
- Set includes a vinyl storage pouch



SIZES	PART #
8.5 in.	142015
8.5 in. card of 10	142016
11.5 in. single	678005
11.5 in. pair	678006



**MOTION PRO OIL FILTER &
CLUTCH HUB SPANNER**

- Equivalent to large end of Honda OEM tool 07716-0020100
- Premium quality high carbon steel
- Heat treated for strength and durability
- Durable hot black oxide finish |
- Use with a 3/8 inch driver
- Inside diameter is 24mm
- Designed to fit oil filter & clutch hub nut on many Honda models (single and twin-cylinder machines)
- Use "Search by Vehicle" to determine the proper spanner nut socket for your specific application



142023

**MOTION PRO DELUXE
AUXILIARY TANK**

- For use with new fuel-injected models with external fuel pumps as well as standard carburetor type motorcycles
- Upgraded petcock for easier opening and closing
- Built-in fuel return (for fuel-injected models) and breather on cap
- Not designed for fuel storage
- Graduated scale located on the side of bottle
- Includes 4 ft. of 1/4 inch fuel line
- Holds up to 2000cc or 1/2 gallon of fluid
- Tank can also be used for refilling transmission oil on some late model MX bikes



142150

**MOTION PRO CARB TOOL 90
DEGREE W/BITS**

- Precision made of aircraft grade aluminum and stainless steel
- Designed for hard-to-reach areas and air/fuel mixture screws on
- multi-cylinder motorcycles
- Gear driven 1/4" hex drive
- Includes five 1/4" hex drive bits (all 1/2" long) - Straight-slot, Phillips, D-shaped air/fuel mixture screw bit, 6 mm hex jet bit and 1/4" -hex-to- 1/4" -drive bit
- Can be used with any 1/4" or 6mm hex bits
- Strongest tool of its type on the market
- Max torque is 60 in. lbs.
- 17.5" long
- Replaceable drive gears
- Limited 1-year warranty
- Replaces OEM Harley-Davidson® #HD-33413-A



142164



MOTION PRO PLIERS, MASTER LINK CLIP

- Designed to simplify installation and removal of clip-type master links
- One tip is shorter and notched to be placed on the pin which allows the longer end to push the clip

142165



MOTION PRO WHEEL BEARING REMOVER 8 PIECE METRIC SET

- 8 piece metric set includes large and small drivers, 10 mm, 12 mm, 15 mm, 17 mm, 20 mm, and 25 mm removers
- Dependable split collet design
- Also available as individual components
- Heat treated for durability and long service life
- One year warranty against manufacturing and material defects

142204



MOTION PRO BEARING DRIVER SET

- Fits bearing with 12-25 mm I.D. and 32-47 mm O.D.
- Adapters can be changed quickly to accommodate a wide range of bearing combinations
- Durable steel handle and anodized aluminum drivers
- Can be used with a hammer or shop press
- Laser etched adapters for easy identification
- Comes with protective blow molded case

144168



MOTION PRO WHEEL BEARING REMOVER

- Dependable split collet design 20mm, 25mm
- Heat treated for durability and long service life

SIZES	PART #
20mm	142201
25mm	142202



MOTION PRO FORK SEAL BULLET

- Protects the fork seal and wiper of inverted forks from damage by the bushing groove during installation
- Eliminates the need to wrap the fork tube with tape
- Fitment size is marked on each bullet for easy identification

SIZES/COLORS	PART #
41MM - BLUE	142209
43MM - GREEN	142210
45MM - YELLOW	142211
46MM - BLACK	142212
47MM - WHITE	142213
48MM - ORANGE	142256
SET - 8PCS	682165



MOTION PRO DELUXE SUSPENSION BEARING SERVICE TOOL



- Designed for quick and easy removal and precise installation of suspension linkage and swingarm pivot bearings
- Designed for use on 20 & 22 mm I.D. bearings
- Fits most off-road motorcycles & ATV's
- Includes blind bearing collet for removal of 20 mm blind bearings (other collet sizes available)
- Anodized aluminum mandrels reduce the possibility of damaging bearing surfaces
- Laser etched markings for easy size identification
- Eliminates the need for a shop press
- Protective blow-molded case for easy storage
- A must have time saving tool for professional technicians, serious racers and home mechanics

142228

MOTION PRO CR SEAL RETAINER AND KTM FORK CAP TOOL



- Versatile design features a 22 mm hex and 3/8" square drive.
- This tool allows removal and replacement of the accessory fork cap KTM part# 48600074S
- The tool is slotted to allow removal and replacement of caps with the P/N 11-0081 Micro Bleeders™
- Also replaces the OEM Honda tool 41231-430-000 to remove and replace wheel bearing/seal retainer rings



142224

MOTION PRO BELT TENSION GAUGE

- Compact design
- Scale for easy reference
- Designed to work with all belt drive models with a 10lb specification

142270

MOTION PRO T6 TRAIL BEAD BUDDY



- No more fighting to keep the bead down while installing or repairing your off-road tires
- Holds the tire bead down in the drop center of the rim during tire changes
- Machined from tough 6000 series aluminum with blue anodized finish and laser engraved logo
- Light weight and compact enough for any tool pack
- Delrin® securing thumb screw keeps rims scar free
- NOT recommended for use with Bib Mousse tube

142304



MOTION PRO OIL FILTER REMOVAL TOOL



- For easy removal of recessed KTM oil filters
- Conical point screw pierces and grabs the sheet metal end cap on filter
- Contoured handle provides a secure grip
- Reduces potential damage to the engine cases
- Not for use on reusable oil filters

142314



MOTION PRO WHEEL BEARING REMOVER SET FOR HD (3/4", 1" & 25 MM)

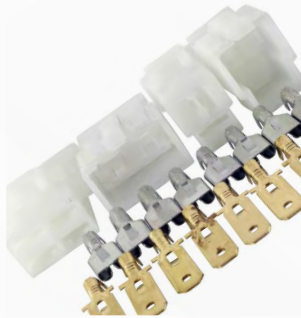

- Set uses a split collet design to remove radial ball bearings on Harley-Davidson® and American V-Twin motorcycles
- Kit includes large driver, 3/4", 1", and 25 mm collets
- All 2007 Softail models, except Springer models, use a 25 mm radial ball bearing on the front wheel
- Heat treated for durability and long service life
- One year warranty against manufacturing and material defects

142321



MOTION PRO FORKTRU™ - FORK ALIGNMENT TOOL

- Quick and easy to use tool for aligning front forks to ensure they are parallel from top to bottom
- Knurled adjustment screws for easy setup
- Reduces stiction and improves the performance of your front suspension
- Reduces seal and bushing wear
- Fits most MX and off-road motorcycles (does not work on most sport bikes due to large brake rotor diameter and 17 inch wheel diameter)
- Will work on 27 mm - 62 mm fork legs and tubes
- Works on forks that are 140 mm to 220 mm on center
- Patented design

142323

MOTION PRO COMPRESSION BOLT REMOVAL TOOL FOR WP 4860 MXMA CC



- Fits 2007 through 2017 KTM models with WP 4860 MXMA CC forks
- For removing and installing the compression valve assembly from the fork cap
- Also works for installation and removal of compression unit on RH fork on WP AER 48 mm fork, commonly found on 2019 through 2023 KTM SX/F, XC/F models
- Allows you to properly torque the compression valve assembly during installation
- 17mm hex head
- Made from billet 6061 T-6 aluminum
- Anodized finish with laser engraving
- Caution: fork cap assembly under pressure! Always wear safety glasses and refer to the fork manufacturer for correct assembly and disassembly procedures.

142346



MOTION PRO TIPROLIGHT™ TITANIUM COMBINATION WRENCH

- Made from tool-grade titanium alloy
- Extremely lightweight and compact design is perfect for trail tool packs
- Exclusive Motion Pro design for optimized strength and performance
- Titanium alloy will never rust or corrode
- Ergonomic handle
- Laser etched markings for easy identification
- Patented design

SIZES	PART #
10mm - 16g	142367
12mm - 18g	142368
13mm - 20g	142369



SIZES	PART #
Set of 4 (8,10,12,14mm)	142371
Set of 4 (8,10,12,13mm)	142382



MOTION PRO FORK CAP SOCKET, SHOWA BPF



- Used to remove aluminum fork cap on Showa BPF 43mm forks
- Fits 8 sided 45 mm fork cap
- Durable blue anodized finish
- Replaces Honda oem tool 07AMA-MGPA100
- Replaces Kawasaki oem tool 57001-1741
- Replaces Suzuki oem tool 09941-53670-LPT

142377

MOTION PRO AIR GAUGE HOLDER

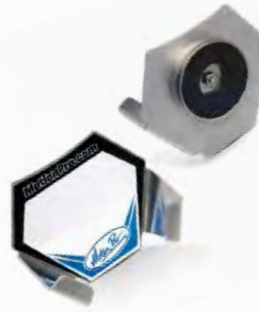

- Aluminum Gauge holder designed for use with Motion Pro Professional and Digital Tire Gauges
- Magnet on back allows for quick mounting to any metal surface or can be used without magnet for permanent mounting
- Eye catching number plate graphics with space for personalized race numbers

142379

MOTION PRO STEPLESS CLAMP FUEL LINE FITTINGS KIT



- Convenient kit includes 70 pcs of hardware, a Motion Pro Side Jaw Pincer tool, and a convenient fuel line clamp size chart
- Kit includes following items packed in a convenient storage box:

143504

Contains:

SIZES	PART #
7.8mm to 9.5mm range, 10 pcs	142612
9.6mm to 11.3mm range, 10 pcs	143502
10.3mm to 12.8mm range, 10 pcs	142613
10.8mm to 13.3mm range, 10 pcs	142614
12.0mm to 14.5mm range, 10 pcs	142615
13.2mm to 15.7mm range, 10 pcs	143503

MOTION PRO SHOCK SPANNER PUNCH



- Ideal tool for turning hard to reach lock ring and preload ring on rear shocks
- Angled brass tip gives secure bite and protects ring from damage
- Heavy duty construction
- Long shaft to reach hard to get at shocks

143457

MOTION PRO BEARING REMOVER



- Dependable split collet design, 22mm
- For use with 142195 Bearing Removal Driver, Large
- Great addition to 142204 Metric Driver Set
- Heat treated for durability and long service life

144152



MOTION PRO RINGER® FORK SEAL DRIVER



- Innovative design makes tool easier and safer to use than old fashioned pin aligned drivers
- Anodized aluminum locking ring features knurled finish for secure no-slip grip and positively locks body halves together during use
- No more worrying about part of the tool falling off and damaging the fork leg or hitting your feet
- Perfectly weighted to drive seals
- Body halves are machined from durable carbon steel and feature high quality protective black e-coat with laser engraved markings
- Lifetime Limited Warranty
- Patented design

SIZES	PART #
35-36mm	143460
37mm	143461
39mm	143462
41mm	143463
43mm	143464
45mm	143465
46/47mm	143466
48mm	143467
49mm	682109
50mm	682110



MOTION PRO T6 COMBO LEVER ADAPTERS

- New, improved version of original RimShield
- Made with genuine DuPont™ Zytel® super tough nylon resin for unmatched strength and durability
- Prevents rim damage from tire levers during tire changes
- Dual raised beads facilitate inserting tire lever under tire bead and prevents tire lever from slipping



DESCRIPTIONS	PART #
Lever Hex Adapter, 32mm to 27mm/22mm	144361
Lever Hex Adapter, 32mm to 27mm/17mm	144375
Lever Set, 32mm, 10/12mm, 22/27mm Adapter	682164
Lever Adapter 32 mm to 3/8" Drive	678370
Lever Adapter 27mm to 3/8 In Drive	678327
Lever Adapter 24mm to 3/8" Drive	678326

MOTION PRO BEADPRO™ TIRE BEAD BREAKER AND LEVER TOOL SET



- Innovative multi-use tire tool set
- Breaks the bead on most street and off road motorcycle tires
- Integrated tire spoons for tire removal and installation
- Light weight and compact size is perfect for tool packs (just 9 ounces for set of 2)
- Length of each lever is 249 mm (9.8")
- Ergonomic handles with crossguard to keep hand from riding forward
- Forged 7075-T6 aluminum construction for strength and durability
- Black anodized finish
- Patented Design

143834

MOTION PRO MINI BLEEDER



- Combines wrench and bleeder valve into one convenient and compact tool
- Bleeds brake systems and hydraulic clutch systems
- Internal check valve for fast easy bleeding
- Anodized billet aluminum handle with chromoly steel body
- Compact size for tight spaces
- High quality internal seal
- Multi-position handle

SIZES	PART #
8mm	143835
10mm	144149



MOTION PRO FORK CAP TOOL FOR KYB, 49MM



- For removing the fork cap and compression cartridge on twin chamber KYB forks found on late model Honda, Husqvarna, Kawasaki, and Yamaha off-road motorcycles
- Outer ring fits 49 mm octagonal fork cap
- Inner body holds cartridge so it can be removed from fork cap
- Outer ring can be clamped in vise to hold fork cap securely while cartridge is being removed
- Provides more secure grip on fork cap and cartridge and reduces risk of damage during disassembly
- Easier and faster to use than any other tool now available
- Billet 6061 aluminum construction with anodized blue finish
- 1/2" square drive
- Lifetime limited warranty
- Patented design

144151

MOTION PRO VALVE STEM SEAL INSTALL TOOL



- Properly aligns valve stem seal to valve guide so seal snaps on straight every time
- Holds four valve guide seals at one time for quick and easy installation on multi valve cylinders
- Contoured design in bottom of handle cradles and protects the delicate inner lip of the valve stem seal while directing tool force to the sturdy outer rim.
- Slim profile allows easy access to valve guides even on modern compact heads with deep lifter bores
- Rounded tip will not damage inner lip of valve stem seal or valve guide bore
- Anodized aluminum handles with stainless steel pilot shafts
- Lifetime Limited Warranty

SIZES	PART #
5.5mm	144153
Set, 4pc 4, 4.5, 5 & 5.5mm	144156
4.0mm	144277
4.5mm	144278
Hayabusa 5.0mm	144280

MOTION PRO BEADPRO™ FS (FORGED STEEL)



- Heavy-duty shop version of our innovative BeadPro™ tire tool
- Innovative multi-use tire tool set
- Breaks the tire bead on most street and off-road motorcycles and ATVs
- Integrated tire spoons for tire removal and installation
- 16" long handles makes removing and installing tires a breeze
- Ergonomic design with crossguard to keep hand from riding forward
- Chrome vanadium forged steel construction for heavy-duty shop use
- Durable satin chrome finish
- Weight of set is 2 lbs
- Patented Design

144155

MOTION PRO AXIS™ TRUING-BALANCE STAND



- Precision built tool for building, truing, and balancing wheels
- Innovative single sided design allows easy access to spokes and nipples
- High quality bearings allow precise wheel balancing
- 15 mm axle fits most modern street and dirt bikes and many mini bikes
- Hub cones hold wheel firmly in place. Cones work with wheel bearing I.D. from 18 mm to 32 mm
- Adjustable pointer for truing wheels
- Simple folding design for easy storage when not in use
- Can be used with dial indicators (not included)
- Durable powder coat finish
- Not designed for use with single-sided swingarm wheels or wheels with centerless hub

144157



MOTION PRO T6 COMBO LEVER SET, 27 MM & 12/13 MM



- Tire spoon with axle nut hex wrench and tire spoon hex wrench for rim lock nut set
- Both levers have perfectly contoured tire lever on one end
- One lever has unique combination stepped 12/13 mm box end wrench on other end for turning rim lock nuts
- Unique no-pinch tip on one lever helps protect inner tube during tire installation
- Second wrench has hex box wrench for 27 mm axle nuts on other end
- Made from lightweight forged 7075-T6 aluminum
- Hard anodized finish
- Under 10 inches in length and weigh only 3.5 oz.
- Hex ends for axle nuts are rated for a maximum torque of 90 lb/ft

144160

MOTION PRO STEERING STEM BEARING TOOL



- Removes and installs tapered roller bearing at base of steering stem
- Fits most full size motorcycles with tapered roller bearing at base of steering stem
- Includes 26 mm, 28 mm, 30-31 mm, 35-36 mm race protectors for installing bearing
- Blue anodized bearing protectors are made from 6061 billet aluminum and laser etched for easy identification
- Compact design will fit within most steering stops on lower triple clamp
- Protects steering stem during bearing removal and installation process
- Will not work on applications using loose ball-bearing or caged ball-bearing type steering bearings

144163

MOTION PRO COMBO Y-DRIVE WRENCH



- Innovative dual-use design combines 6 tools into one
- 8 mm, 10 mm and 12 mm hex socket
- 4 mm, 5 mm and 6 mm hex drive
- Padded Y-shape for excellent grip and leverage
- Compact design is ideal for trail tool packs
- Chrome-Vanadium tool steel
- Lifetime Limited Warranty

144164



MOTION PRO MINI SPRING HOOK

- Compact size for easy access
- Ergonomic handle provides a secure grip at every angle
- For use on exhaust pipe springs, seat or tank holding springs, cotter pins, side stand springs and more

144166

MOTION PRO CLASSIC SPOKE WRENCH 5.0 / 7.0MM



- Chrome-vanadium tool steel with a hard nickel pewter finish
- Square-end openings which grip the spoke nipple on all four sides
- Offset slotted ends make it easy and quick to use

6780296

MOTION PRO REAR BRAKE KIT/BLASTER (EA)



- YAMAHA BLASTER REAR BRAKE CABLE.
- This cable will eliminate the stock cable from the handlebar.
- Cable wire goes from the rear brake cable to the caliper.

MFG	PART #
MFG 01-0298	671298
MFG 01-0299	671299



MOTION PRO SPINNER T-HANDLE, BIT DRIVER



- Low friction bushing mounted spinner provides faster and easier removal and installation of bolts and nuts
- 1/4 inch hex drive head accepts most common driver bits
- For use with non-quick release 1/4" hex bits only
- Not compatible with 08-0590 Magnetic Nut Driver Set
- Magnet inside drive head holds drive bits firmly in place
- Narrow drive head profile fits into tight spaces
- Padded grip handle
- Chrome vanadium handle and shaft
- Durable chrome finish on shaft and handle
- Blue anodized spinner with laser engraved Motion Pro logo
- Shaft is 8 inches long
- Bits not included
- Lifetime Limited Warranty

144171

MOTION PRO T-HANDLE BIT DRIVER WITH NO. 1, 2, 3 JIS CROSS-POINT BITS



- High quality Motion Pro standard bit driver T-handle
- Features three 1/4 inch drive heads, one at end of shaft and two at each end of handle with magnets to hold drivers firmly in place
- Includes high grade S2 tool steel JIS cross-point bits no. 1, no. 2, and no. 3, but also accepts all common driver bits
- The included JIS cross-point bits are a must have for most Japanese made bikes and work equally well on traditional Phillips head screws. Use of traditional Phillips driver on JIS cross head screws will damage screw head.
- For use with non-quick release 1/4" hex bits only
- Narrow drive head profile fits into tight spaces
- Chrome vanadium handle and shaft
- Durable chrome finish on shaft and handle
- Shaft is 8.5 inches long
- Lifetime Limited Warranty

144172

MOTION PRO MICRO BLEEDER™



- Ultra-compact, low profile design is only 11 mm high installed
- Stainless steel body is stronger and will not corrode
- Easy to install, simply replace the OE bleeder screw with the Micro Bleeder
- Reduces harshness caused by air build-up
- Allows bleeding of air pressure without tools
- One of the easiest bolt-on upgrades you can make to your forks
- Kit includes two bleeder valves



MOTION PRO STEPLESS EAR CLAMPS

- 8.8MM TO 10.5MM RANGE, 10 PCS
- Convenient kit includes 70 pieces of hardware, a Motion Pro Side Jaw Pincer tool, and a convenient fuel line clamp size chart
- Narrow 5mm wide band provides concentrated seal compression
- 360° Stepless? design with no gaps on inner surface
- Specially formed strip edges reduce the risk of damage to the part being clamped
- Lightweight design
- Tampering is visible
- Kit includes 10 each of the clamps listed below in a convenient storage box
- Individual clamp sizes available separately in 10-pack for restocking

144296

SIZES/COLORS	PART #
M5x0.8 for Showa (Gold)	144190
M5x0.8 for KYB (Silver)	144194
M4x0.7, WP 4860 MXMA, 4CS Black	144292
M4x0.7, WP 43-48 W/O Ext Preload, Orange	144293



MOTION PRO PIVOT SUSPENSION VISE



144374

- Designed to make suspension service simple and quick
- Holds shocks and forks securely while you change oil, re-valve, or change seals
- Pivoting head holds parts in any position, with mechanical stops every 45 degrees
- Aluminum Soft Jaw Vise holds cylindrically shaped parts utilizing a 4 point grip system
- Large side holds 39 mm to 69 mm diameter parts
- Small side holds 14 mm to 39 mm diameter parts
- Steel Frame is rigid yet has a small footprint, with 4 pre-drilled holes in the base for secure mounting to a bench
- Movable fluid catch pan with mesh insert, and threaded drain bung

HOW IT WORKS ON FORKS

- Soft Jaw Fork Peg holds fork slider up for removal of dust seal and seal retaining clip
- Repositionable bottom slide bar holds forks compressed while bleeding air (priming cartridge) during reassembly and is an excellent platform for adding, adjusting and taking fork oil level measurements
- Can be used to assist in removing compression valve assembly (use of stock front axle required)

HOW IT WORKS ON SHOCKS

- Holds shock firmly around shock body, shaft or shock reservoir
- Facilitates removal of piston rod and seal head
- Facilitates removal of shock reservoir caps, chamber pistons or bladder
- Holds shock to remove spherical bearings or needle bearings
- Holds shocks for removal of shock spring



MOTION PRO CRANKSHAFT PULLER



- Precision tool used to install press-in crank shafts into an engine case
- Time saving method maintains crank shaft true during installation
- Universal steel nut adapter works on virtually all crankshafts
- 25mm and 40mm billet aluminum face plate adaptors ensure crankshaft is pulled perfectly straight into bearings
- Reversible pull stud with both M10x1.25 and M12x1.25 threads
- Eliminates the need for a shop press to install crankshaft
- Machined brass thrust washer for extra durability

144379

MOTION PRO 36MM AXLE SOCKET FOR H-D®



- Facilitates loosening and tightening of hard to reach rear axle nut on HD baggers
- Fits 36 mm axle nuts
- Captive swivel extension with 1/2 inch drive
- Rated for up to 175 pound-feet of torque
- Durable plastic sleeve protects exhaust system
- Corrosion resistant black oxide coated
- Lifetime limited warranty

144380



MOTION PRO COUNTERSHAFT SEAL PULLER



- Safely removes countershaft seals with an ID of 29 mm to 47 mm
- Works on off road, street and ATV engines
- Unique expansion mechanism ensures seal is pulled straight and will not damage engine cases during extraction
- The only puller designed specifically for countershaft seals
- Durable steel construction

144381

MOTION PRO T-6 VALVE SPRING COMPRESSOR W/ 24 MM ADAPTER



- Quick release system presses straight against the retainer to eliminate side loading the valve and keepers
- Works on all motorcycle, ATV, UTV, and small engine cylinder heads
- Billet 6061 aluminum frame provides unmatched strength and stiffness and lower weight
- Fully adjustable top and bottom
- Aluminum lower adjuster will not damage or scratch valves
- Includes universal fork style tip (24mm outside diameter)
- Durable blue anodized finish with laser engraved markings
- Simple, fast, and easy to use

144382

MOTION PRO SPROCKET JAMMER™



- Prevents rotation of chain and sprockets for easy removal or installation of counter shaft nut
- Can be used to pull rear wheel against chain blocks when tightening rear axle
- CNC billet aluminum construction
- Blue anodize and laser etching for easy identification
- Patented Design

144383

MOTION PRO 5 IN 1 DAMPER ROD BLEED TOOL



- Tool design allows for effortless retrieval of damping rod after spring installation
- Perfect for working on Kayaba, Showa and WP inverted forks
- One piece design means no lost parts
- Rod includes downward facing bleed port to prevent oil splatter
- Five thread sizes in one tool: M10 x 1.0, M10 x 1.25, M12 x 1.0, M12 x 1.25 and M14-1.0
- Precision billet aluminum construction with durable blue anodized finish and laser engraved markings

144384





MOTION PRO TWO-STROKE LEAK DOWN TESTER (DETECTOR)



- Designed to check for air leaks in 2-stroke engines
- Includes air pressure gauge, pump-up bulb and most fittings and adapters for single and twin cylinder 2-stroke motorcycle engines
- Packed in a convenient carry box, complete with instructions

678071

MOTION PRO DEGREE WHEEL



- Manufactured from .052 in. thick aluminum with a 6 3/4" outside diameter and a 6mm center hole
- Black anodized finish with easy to read numbers
- Check or set ignition and/or cam timing
- May be used on 2 & 4-stroke engines

678092

MOTION PRO HEAVY-DUTY SPRING HOOK



- The T-handle adds security to your grip when applying tension to the spring
- Used to remove exhaust pipe springs, seat or tank holding springs, cotter pins, sidestand springs and other parts

678127

MOTION PRO DUAL IGNITION SYSTEM TESTER



- Test the integrity and strength of your ignition system
- Spark gap is adjustable from 0 to 10mm
- The larger the gap your ignition will jump, the stronger your system is
- Will test the ignition on most motorcycles, watercraft, ATVs & snowmobiles

678122

MOTION PRO T-HANDLE SOCKETS



- Metric T-Handles feature a durable nickel pewter finish
- Deep 6-point sockets
- Limited lifetime warranty

SIZES	PART #
8mm	678093
10mm	678094
12mm	678095
19mm	678099

MOTION PRO CLASSIC SPOKE WRENCH



- Chrome-vanadium tool steel with a hard nickel pewter finish
- Square-end openings which grip the spoke nipple on all four sides
- Offset slotted ends make it easy and quick to use

SIZES	PART #
6/6.3mm	6780133
6.5/6.8mm	6780157



MOTION PRO QUAD-STAKE RIVET KIT



- This accessory for the 08-0135 Jumbo Chain Tool will safely and properlypeen soft-nose-type master link pin tip
- Specifically designed for use in the 08-0135 Jumbo Chain Tool
- Retain that factory quad stake look

678142

MOTION PRO HYDRAULIC BRAKE BLEEDER



- Makes bleeding your brakes a one-person job
- Billet aluminum body with internal check valve
- Will not bleed air from a dry system
- Instructions included

678143

MOTION PRO T-HANDLE DRIVES



- Use any 1/4" or 3/8" drive attachments such as sockets hex drives crows foot or swivels
- Chrome vanadium tool steel shafts
- Durable nickel pewter finish

SIZES	PART #
1/4" Drive / 8-1/2" Long	678158
3/8" Drive / 10-1/2" Long	678159

MOTION PRO SPARK PLUG SOCKET 18MM



- Thin wall design to fit into low clearance plug cavity
- Socket can be driven with various tools including the Motion Pro spark plug ratchet wrench, 3/8" ratchet, 13/16" wrench, tool kit bar, or a Phillips screwdriver placed through the 8.5 mm hole at the top of the socket
- Outer diameter 23.94mm (0.943")
- Has a length of 110mm (4.3")
- Lifetime Limited Warranty
- Use Search By Vehicle to determine the proper spark plug socket for your specific application

678175

MOTION PRO BALL END ALLEN SET



- Made of chrome-vanadium tool steel
- Ball end allows for better access to allen-head bolts (up to 25° working angle)
- Convenient holder included
- Sizes: 1.5, 2, 2.5, 3, 4, 5, 6, 8 and 10mm

678185

MOTION PRO SNAP RING PLIERS



- Economical pliers that easily work with both inside and outside opening snap rings or clips
- Set includes four interchangeable tip sets. (Straight and 45°) for eight different internal and external use combinations
- Effective range 10 mm – 50 mm (3/8" – 2")
- Non-slip rubber grip handles

678186



MOTION PRO T6 COMBO LEVERS



- Perfectly contoured tire spoon on one end
- Lightweight forged 7075-T6 aluminum
- Hard anodized finish
- Under 10 inches in length and weigh only 3.5 oz.
- Hex end is rated for a maximum torque of 90 lb/ft

SIZES	PART #
T6 Combo Lever 12/13mm	678284
T6 Combo Lever 22mm	678286
T6 Combo Lever 24mm	678287
T6 Combo Lever 27mm	678288
T6 Combo Lever 32mm	678289

MOTION PRO FLYWHEEL PULLER, YFM, M35X1.5 R.H. INTERNAL THREAD X 75 MM



- Equivalent to Yamaha tool YM-01404, Kawasaki tool 57001-1223, Suzuki 09930-34960
- Used for removal of the flywheel or rotor if applicable
- Premium quality high carbon steel
- Heat treated for strength and durability
- Durable hot black oxide finish
- Laser etched with Motion Pro logo and part number
- Use "Search by Vehicle" to determine the correct flywheel puller for your specific application
- Lifetime Limited Warranty

678349

MOTION PRO FLYWHEEL PULLER, M28 X 1.0 R.H. INTERNAL THREAD W/M14 CAP



- Equivalent to Honda tool 070MC-HP1A100 with crankshaft protector 070MC-HP1A110
- Used for removal of the flywheel or rotor if applicable
- Premium quality high carbon steel
- Heat treated for strength and durability
- Durable hot black oxide finish
- Laser etched with Motion Pro logo and part number
- Use "Search by Vehicle" to determine the correct flywheel puller for your specific application
- Lifetime Limited Warranty

678372

MOTION PRO HEX AXLE TOOL 17,19,22,24 MM, CHROMOLY



- Fits internal axle hex on many late model sportbike and some dirt bikes
- Four metric hex sizes: 17, 19, 22 and 24mm
- 3/8" square drive on both ends
- Heavy duty chromoly steel construction for shop use
- 3/8" square drive on both ends rated to 150 lb/ft
- Use wrench on external hex of tool for situations exceeding 150 lb/ft

678397

MOTION PRO NITROGEN SHOCK GAUGE & FILLER



- 300 PSI capacity
- Bleeder valve & T-handle plunger pin chuck
- Swivel chuck has a 12" flexible hose
- Instructions, carrying box and Schrader valve extension included (required on some Showa shocks)

680072



MOTION PRO RACK FOR T-HANDLE SET



- Easily hangs on the side of most tool boxes
- Precision cut steel construction
- Chrome plated for durability
- Keeps T-Handles accessible and ready for action
- Holds up to 11 T-Handles

680144

MOTION PRO WALL BRACKET FOR T-HANDLE RACK



- Features a quick release pin for removing and attaching the T-Handle rack
- Includes built in bottle opener
- Made from heavy-duty 12 gauge zinc plated steel
- Wall Bracket works only with our new one piece design style T-Handle rack

680435

MOTION PRO U-JOINT SEPARATOR



- Designed to press bearing cups out without damage to the bearings or the yoke
- Compact design allows U-Joints to be disassembled on the vehicle
- Durable hardened steel construction with black oxide coating
- Fully adjustable arms will fit most UTV and ATV applications
- Original Motion Pro Design
- Not for use with impact guns
- Tool used for U-joint disassembly only
- Lifetime limited warranty

682746

MOTION PRO - PRO SPARK PLUG SOCKET™ - 14 MM



- Fits 14 mm spark plugs
- Ultra-strong tool steel construction
- Slim skeleton profile
- Use with a 3/8" square drive or 17 mm wrench
- Innovative internal plug retention system
- Protective black oxide coating
- Easy to read laser etched markings
- Can be used as an axle holding tool on bikes with 17 mm internal hex axles. Through hole allows use of screwdriver or holding rod
- Light weight
- Outer diameter 19.25 mm (0.758")
- Lifetime limited warranty
- Patented Design

682178

MOTION PRO HEAVY DUTY PIN SPANNER



- Designed for removal and installation of shock reservoirs, screw-in seal heads, fork caps, and bearing retainers.
- Freely pivoting arms span a range of 10.5 mm to 150 mm
- Interchangeable 3 mm, 4 mm, and 5 mm hardened steel pins
- 3/8" square drive for use with a breaker bar or torque wrench
- Curved, low profile arms easily fit tight areas
- Billet heat treated steel construction for increased strength, rigidity and durability
- Durable black oxide finish with laser engraved markings
- Replacement pins available (part number 08-0705)
- Maximum torque rating of 70 lb-ft
- Patented design
- Lifetime limited warranty on body of tool (warranty excludes pins)

682191



MOTION PRO - PRO FORK OIL LEVEL TOOL



- Use this tool to check and adjust the oil level on conventional and single chamber cartridge forks
- Adjustable ring will measure oil levels from 0 to 300 mm in 5 mm increments
- Syringe has a capacity of 60 ml
- New plunger head design features two fluorocarbon elastomer X-Ring seals that provide superior sealing and chemical resistance
- Billet aluminum plunger knob with durable black anodized finish
- New plunger head design allows easy cleaning and replacement of seals
- Can be used on bicycles equipped with front suspension

682244

MOTION PRO SHOCK BEARING PULLER



- Safely removes and installs the upper spherical bearing on rear shocks
- Fits 24mm OD bearings
- Durable hardened tool steel construction
- Corrosion resistant black oxide coating
- Laser etched for easy identification
- Reversible puller cup with cutaway fits a wide variety of shock reservoir and compression adjuster configurations
- Durable brass thrust washer
- 1 year limited warranty

682193

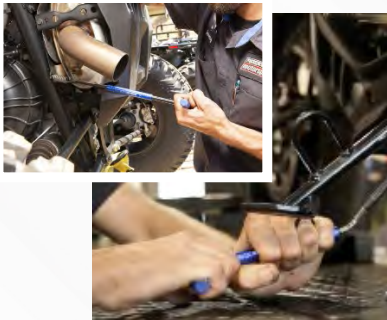

MOTION PRO TUFF HOOK™

- Heavy-duty design for use on large exhaust and kickstand springs
- Multi-function tip easily pulls or pushes large springs on and off mounts
- Flexing shaft is ideal for hard to reach springs with minimal working space
- Locking shaft slider allows the center of the shaft to be rigid or flex
- A must have for UTV and snow machine exhaust systems
- Billet aluminum construction handle and locking shaft slider
- Steel shaft with heavy-duty stainless steel flex insert
- Lifetime Limited Warranty

682208



MOTION PRO YAMAHA IDLE KIT



- Used to install a standard Mikuni idle adjuster into the carburetor body
- For use on Yamaha Banshee and Blaster models
- Idle adjuster is necessary if carburetor top has been replaced with a standard Mikuni cap
- Kit includes a drill bit (#6), thread tap (6 mm x .75 mm), 2 idle screws with lock nuts and instructions
- Drill press or mill should be used to drill holes in the carburetor bodies

678045

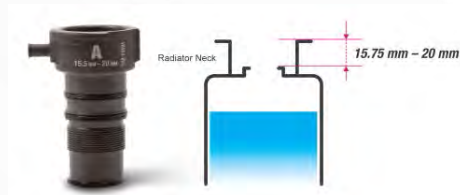

Measure your radiator neck to confirm correct size for your application.

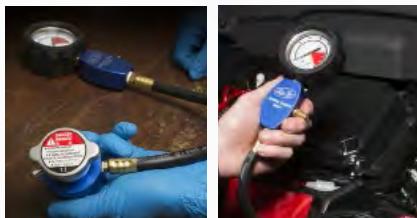

MOTION PRO COOLING SYSTEM TESTER, TYPE A

Designed to work on radiator necks ranging from 15.75 mm - 20 mm

Specified range is most commonly found on Japanese manufactured radiators and can also be found on some late model water-cooled American V-Twin.

- Pressurize motorcycle or ATV cooling system to check for leaks
- Tests radiator and radiator cap for leak and correct pressure release limit
- Use with a common hand pump to pressurize a non-running system (pump not included)
- Remote, accurate, easy to read gauge makes readings and diagnosis easy
- Unique design allows you to test the cooling system on a running engine to check for leaks or excessive pressure when system is hot
- Unique radiator adapter will work with most motorcycle, ATV and UTV applications equipped with a 30 mm spout
- Type-A kit is designed to work on radiator necks ranging from 15.75 mm - 20 mm
- Specified range is most commonly found on Japanese manufactured radiators, 2016 and up KTM, and can also be found on some late model water-cooled American V-Twins
- Measure your radiator neck to confirm correct size for your application

682204

MOTION PRO COMPRESSION TESTER WITH 10 MM, 12 MM AND 14 MM ADAPTERS



- Helps you to quickly and easily inspect engine compression on both 4 stroke and 2 stroke engines
- Redesigned and Improved billet gauge manifold with integrated pressure release valve
- Easy to read precision 0-300psi analog gauge with protective rubber boot
- Hose and adapters included for 10 mm, 12 mm and 14mm spark plugs
- Integrated quick disconnect fitting for easy hose installation and removal
- Nylon storage pouch

682245

MOTION PRO DIGITAL 4-STROKE LEAK DOWN TESTER



- Accurately displays the total percentage of leakage past the rings, head gasket, intake and exhaust valves
- Speeds up troubleshooting and helps to isolate bad components
- Precision digital display provides accurate, easy to read results
- Easy to use precision pressure regulator built into body of tool
- Rugged rubber boot protects digital gauges
- Tests at 80, psi cylinder pressure. Requires 90 PSI air source.
- Includes 1/4" male industrial quick connector
- Meets FAA leak down test specifications for cylinders below 5.00" (127 mm) bore diameter
- Hose and adapter fits 10 mm, 12 mm, 14 mm spark plug threads
- Includes convenient molded tray and instructions
- Patent pending

682247



MOTION PRO - PRO FUNNEL™



- Integrated shutoff valve allows precise amount of liquid to be dispensed
- Graduation marks for cubic centimeters, fluid ounces and premix ratio
- 800 cc capacity
- 26 oz capacity
- Easy to understand premix ratio graduations for 32:1, 40:1, 50:1, and 60:1 for 1 to 3 gallons
- Adjustable ball-pivot spout allows easy, spill-free filling
- Top cover keeps dust and dirt out when not in use
- Magnet allows funnel to be stored conveniently on the side of your tool box
- Large molded handle for secure grip
- Reduced neck keeps funnel from dripping residue when funnel is laid on its side
- Made from ultra-durable HDPE plastic
- Tip size can be trimmed to fit your application

682296

MOTION PRO STEERING HEAD RACE PULLER II



- Designed to quickly and precisely remove outer bearing race from the steering head without the use of a hammer and punch
- Puller design ensures bearing is pulled perfectly straight to eliminate possible damage to frame
- Fits tapered bearing races with OD from 47 mm to 55 mm and ID from 37.5 mm to 45 mm
- Precision machined anodized aluminum cup will not damage seal surface
- Brass bearing washers for easy use and long life
- Hardened steel jaws engage securely on inner bearing lip
- Lifetime limited warranty

682307

MOTION PRO COMPRESSION ADJUSTER, KYB AOS



- Designed to fit motorcycles fitted with KYB AOS/SSS forks without toolless compression adjuster
- Allows for easy adjustments to compression damping without the use of tools
- Fits Stark Varg and allows clicker adjustment with phone mount in place
- Includes Motion Pro Micro Bleeder Set Part No. 11-0095 to allow for tool-free fork bleeding
- Anodized billet 6061 aluminum construction with stainless steel adjuster knob
- Requires 10 mm handlebar clearance above top of fork cap
- Kit includes complete set to fit both fork legs

682308

MOTION PRO HEAVY-DUTY CLUTCH HOLDING TOOL



- Securely holds clutch hubs on most motorcycles and ATVs
- Can be used to remove the locking ring on UTV fuel cells to remove fuel pumps
- Reversible blades work on conventional square spline and on round spline style (KTM/Husqvarna) clutch hubs
- Aircraft grade billet aluminum body with durable blue anodized finish
- Precision machined stainless steel blades are strong and durable
- Billet aluminum clamp knob for fast and easy installation and removal
- Extended knurled handle provides sure grip when removing or torquing the clutch hub nut
- Tool jaws have a range of 75 mm (2.9 in) to 120 mm (4.72 in)

682309



**MOTION PRO XR BEARING
RETAINER TOOL**



- Replaces OEM tool 07710-0010100 to remove and replace the rear wheel bearing / seal retainer ring, part number 41231-429-000 and 41231-286-000
- Design features a 19 mm hex
- Precision design prevents damage to the retainer ring after peened stakes have been removed by drilling
- For use on: XR650L 93-07, XR600R 85-00, XR500 79-84, XR350R 83-85, XR250R 84-95, XR200R 81-02, XL200R 83-84, XL250K 72-76, MR250 76, CR250M 76

142162

**MOTION PRO 44MM CR
BEARING RETAINER TOOL**



- Versatile design features a 22 mm hex and 3/8" square drive
- Precision design prevents damage to the retainer ring after peened stakes have been removed by drilling
- 44 mm, to remove and replace the rear wheel bearing/seal retainer ring, part number 41231-KZ4-000
- For use on; CR125/250R 84-99 and CR500R 84-01

142163

**MOTION PRO 47MM CR SEAL /
BEARING RETAINER TOOL**



- Features a 22 mm hex
- Precision design prevents damage to the retainer ring after peened stakes have been removed by drilling
- For use on 47 mm lock rings
- Premium quality high carbon steel
- Durable hot black oxide finish
- Replaces OEM tools 07HMA-KS70100, and 07YMA-KZ40100 to remove and replace the rear wheel bearing / seal retainer rings, part numbers 41231-KZ4-J20 and 41231-KS6-700
- For use on CR125/250R 00-07, CRF450R 02-07, CRF450X 05-08, CRF250R 04-07, CRF250X 04-07

142191

**MOTION PRO SEAL MATE FORK
SEAL CLEANER**



- Easy way to keep your fork seals clean and debris free
- Extracts dirt and debris trapped between fork seal and tube
- Will work on conventional and up-side down forks

QTY	PART #
card of 12	142275
each	142311

**MOTION PRO TEE CONNECTOR
3/8 PK/10**



- White fuel-resistant plastic (Acetal)
- Fitting used to run two hoses into one
- May be used with O-Clips or hose clamps
- Sold in packs of 10
- Warning: Not for use with fuel injected engines

142561

**MOTION PRO - PRO SEAL
PULLER™**



- Easily remove stubborn seals without damaging engine cases or wheel hubs
- Includes 3 interchangeable puller tips to accommodate a wide range of seal sizes
- Wide tip footprint aids easy seal removal
- Knurled handle provides secure grip and leverage
- Machined from heat treated 6061-T6 billet aluminum for superior strength and durability
- Anodized finish with laser etched logos
- Patented design

682172



MOTION PRO BLIND BEARING REMOVER KIT



- High quality blind bearing puller you will be proud to use and own
- Includes 8, 10, 12, 15, 17, 20, 25, 30, and 35 mm collets
- Collets are precision machined for perfect fit and durable performance
- Collets have a innovative new design that improves durability and pulling strength
- Pull tests in our lab show our collets are 2x to 3x stronger than conventional collets
- Kit includes high quality slide hammer designed by Motion Pro with excellent weight and balance
- Slide hammer and individual collets are also available separately from Motion Pro
- Lifetime limited warranty

682960

MOTION PRO MASTER CYLINDER SNAP-RING PLIERS



- Allows removal of internal snap rings used in hydraulic master cylinders
- Replaces Honda# 07914-SA50001
- Can be used to remove and replace small to medium internal snap rings up to 50 mm deep, including those used for transmission gear locating, bearing retention, and oil seal retention
- Applicable to some fork seal retaining rings
- Hardened tool steel with durable black finish
- Grip covers provide secure grip

142214

MOTION PRO BRAKE CALIPER PISTON TOOL



- Ultra low profile design removes pistons from monoblock disc brake calipers
- Fits pistons with a center bore of 15 mm to 28 mm
- Easy to use single locking screw
- Works on aluminum, steel, and titanium pistons
- Non marring design will not harm pistons or caliper
- Billet aluminum and stainless steel construction
- Durable blue anodized finish

144356

MOTION PRO PILOT SCREW ADJ. TOOL



- Designed for those hard-to-reach air/fuel mixture screws on most multi-cylinder motorcycles
- Straight-slot blade tip can be rotated by rotating the handle
- Length is 17 inches with a 110 degree angled head to extend reach 1 inch.
- Equivalent to Honda OEM #07908-4220201

142087





MOTION PRO VACUUM ADAPTERS



- Brass w/Cap 5mm x P0.80mm (Ea)
- Can be permanently installed on motorcycles that only have a plug in the vacuum port
- Eliminates the need to install adapters before every carburetor synchronization
- Rubber caps are included to seal vacuum

142156



MOTION PRO IDLE SCREW ONLY MIK CARB

- Mikuni Carb idle screw
- Thread size is M6 x P0.75

671026

MOTION PRO MAIN JET WRENCH 6M HEX



- High-quality die-cast construction
- Fits 6 mm hex jets
- Cap compartment will hold a few spare main jets

678023



MOTION PRO FCR CARB TOOL

- Contains longer bits for reaching into recessed cavities to adjust Keihin FCR carburetors
- Ideal for trail riders and garage mechanics alike
- Includes 6 mm hex for main jets, long-reach straight slot for pilot jets & a 3 mm hex for removing the float bowl
- Cap compartment will hold a few spare main jets

678181



MOTION PRO PIN FOR PBR CHAIN TOOL

- May be supported in a vise or held with included handle
- Great for the professional technician or DIY mechanic
- Compact and light enough to carry in a tool bag for trail side repairs
- Includes spare pin
- Patent pending

144330



MOTION PRO VALVE CORE REMOVER



- Allows for easy removal and installation of standard valve cores in tubed or tubeless valve stems (Schrader valve)
- Perfect tool pack accessory
- One year limited warranty

678183

MOTION PRO PBR HOLLOW NOSE RIVET TIP



A replacement part for the Motion Pro PBR Chain Tool (Part Number: 08-0470). It's designed with a hollow nose to effectively rivet motorcycle chains. This specific tip is made of high-quality steel and is a crucial component for chain riveting operations using the Motion Pro PBR Chain Tool.

144335

MOTION PRO AUXILIARY TANK



- For use when tuning a motorcycle with the gas tank removed
- Includes 4 ft. of 1/4 inch fuel line and an inline fuel valve with a 5/16 inch tank side fuel barb and 1/4 inch engine side fuel barb
- On fuel-injected motorcycles, use our 08-0189 Deluxe Auxiliary Tank
- Tank can also be used for refilling transmission oil on some late model MX bikes
- Holds up to 2000cc or 1/2 gallon of fluid
- NOTE : if a 5/16 inch engine side fuel barb is required, use 12-0036 inline fuel valve (sold separately)
- Not designed for fuel storage

142037

MOTION PRO HOSE CLAMP



- Made of corrosion-resistant stainless steel
- Conventional-type worm drive hose clamps
- 1/4 " hex head with screwdriver slot
- Sold in packs of 10

SIZES	PART #
1/4" to 5/8", Pk/10	142562
7/16" to 25/32", Pk/10	142563

MOTION PRO DAMPING ROD HOLDER



- Holds damping rod for inner fork cartridge removal
- Fits damping rod diameters of 10 mm to 14 mm
- 6061-T6 aluminum
- Anodized finish with laser engraving
- Lifetime limited warranty

682866

MOTION PRO PINKLAW PUSH PIN TOOL



- Easily removes plastic push pins from body panels found on UTVs, Motorcycles, ATVs, Cars & Trucks
- Works on all push pins 20 mm diameter and smaller
- Durable, lightweight aluminum construction
- Raised logo on handle provides extra grip
- Small tool size designed for tight spaces
- For use on plastic push pins only

682944

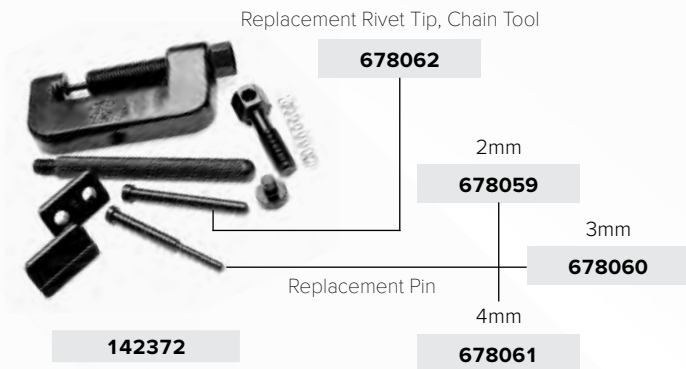

MOTION PRO CHAIN BREAKER, PRESS AND RIVETING TOOL

- Complete chain tool for most 520, 525 and 530 standard, O-ring and X-ring chains
- Break, press, and rivet your chain with one compact tool
- Will rivet hollow nose master links (will not rivet solid soft-nose pins)
- Will push pin completely through link/side plate
- Hardened body, riveting tip and breaker pin for strength and durability
- Removable handle for compact storage
- Perfect for your trail/road tool pack if you have a chain with a rivet master link
- One year limited warranty

MOTION PRO PBR CHAIN TOOL



- Innovative design will Press, Break & Rivet 520, 525, & 530 chains with one convenient tool
- Versatile design will remove chain pins, press master-link plates and rivet hollow nose & soft nose (quad stake) master link pins on O-ring and non O-ring type chains
- Easy to use design allows you to change tool functions by simply moving the position of the anvil block
- Indexing letters on movable anvil and body ensures correct tool configuration. Simply line up the letter on the anvil to the letter on the body to get the configuration you need!
- All components conveniently store on tool when not in use
- Includes protective plastic case for convenient storage of the PBR tool and all its components
- All steel construction with heat treated components for strength and durability
- May be supported in a vise or held with included handle
- Great for the professional technician or DIY mechanic
- Compact enough to carry in a travel tool box, perfect for track side use
- Includes spare pin
- One year limited warranty against defects in workmanship and materials
- Patented design

143820

MOTION PRO JUMBO CHAIN TOOL



- Designed to break roller chain up to 630 (Fits all standard & O-ring chain sizes 520 to 630)
- Designed to rivet chain up to 530 (not 630)
- Master link side plate press kit included to press on side plates on chains up to 530 (not 630)
- Screws & attachments are heat treated for strength and durability
- The extractor pin is precisely guided by a removable guide, ensuring long pin life
- May be bolted to a work bench, supported in a vise or held by handle
- When bolted to a solid surface, air or electric wrenches may be used to break chain
- Recommended for heavy-duty use
- For riveting hollow nose master links
- Requires 08-0142 Quad Stake Rivet Kit (not included) to rivet soft-nose type master link pin tip

678135



MOTION PRO TRAIL TASK™ ADV CHAIN TOOL

- Versatile, light and super compact chain tool for adventure touring and long-distance trail riding
- Complete tool weighs only 230 grams (8 oz)
- Will break 520, 525, and most 530 chains and master links (maximum link width of 20 mm)
- Included steel press plate for removing and installing clip-style press-on master link plates
- Innovative dovetail closure provides ease of use and superior strength
- Tough and strong machined 6061 billet aluminum body
- Hardened steel thread insert on the body provides strength and durability
- High-quality blue anodized finish and black oxide coated drive components
- Includes durable cloth pouch for easy transport on your adventure
- Requires use of 12 mm and 14 mm wrenches (not included)
- Does not rivet master links. We recommend using the Motion Pro PBR Chain Tool part no. 08-0470 if you have a rivet-style master link

682764



Replacement Pin

678002

MOTION PRO CHAIN BREAKER WITH FOLDING HANDLE

- Original Motion Pro design
- Fits 420 to 530 chain
- Will push link pin completely through link / side plate
- Handle folds away for easy storage
- Durable drive pin is heat treated for strength and wear resistance
- Will not work on EK 530 MVO/MVX chain
- Max pin extension to drive out chain links is 18mm. The maximum pin extension required to drive out the chain link is determined by measuring your chains width from outside face plate to outside face plate.
- Beware of imitations! This tool was originally designed by Motion Pro over 30 years ago. Since then, many of our competitors have tried to copy this tool, but none of them have got it quite right. Over the years we have added several new, not so obvious features that enhance the function and durability of this tool. You won't find those features on the copycat versions. You can only get the original and best folding chain tool from Motion Pro.

678001



MOTION PRO CHAIN BREAKER & RIVETING TOOL

- Versatile enough to be used on drive chains and some cam chains
- Will break chains from #35 to #630
- For chain #520 and up, it is recommended to grind the rivet head
- Can assemble 50 series press on master links
- Can rivet hollow nose master links up to #630.
- Each kit includes 3 pin sizes to fit most chains (2mm, 3mm, 4mm)
- Investment-cast, hardened body and redesigned body bolt
- Recommended for light to medium-duty use
- For riveting hollow nose master links only
- Kit includes press plates to rivet 50 series chain only
- For riveting solid nose master links such as those found on EK and Regina chains, use 08-0135 Jumbo Chain tool in conjunction with 08-0142 Quad-Stake Rivet Kit or the 08-0470 PBR Chain Tool.

678058

MOTION PRO BEAD BUDDY® II

- New and improved design of the original Bead Buddy®
- Durable 6061 aluminum with blue anodized finish and laser engraved logo
- A must for installing Bib Mousse tubes
- Used to push the tire bead down into the drop center of the rim on off-road wheels while using tire tools to change tires
- Hooks over spoke and pushes bead down on opposite side of tire from tire irons
- No more fighting to keep bead down while installing off-road tires
- Patented design



6780471

MOTION PRO CHAIN ALIGNMENT TOOL

- Quick and accurate alignment
- Tool body clamps squarely to rear sprocket so the alignment rod will indicate sprocket alignment to chain
- Lifetime Limited Warranty



678048



MOTION PRO MINI CHAIN PRESS TOOL



- Fits most 520 and 530 standard and O-ring chains
- Designed to press side plates onto the master link
- Hex key wrench is included with tool
- Perfect addition for tool packs
- Does not rivet together rivet type master links

678070

MOTION PRO CHAIN BRUSH



- Double ended brush for cleaning chains and other components
- Three sided brush to clean chain rollers and side plates in one operation
- Long straight bristles on opposite end to clean hard to reach areas
- Durable nylon brush and high quality plastic handle

682751

MOTION PRO CHAIN MASTER LINK PRESS TOOL



- Easily presses on and off master link plates for clip style chains
- Works on most 50 series chains
- Maximum master link width 24.8 mm
- Presses on side plates with roller pins up to 5.25 mm (0.207") diameter
- Will not damage master links
- Hardened steel pins for reliable use
- Light weight billet aluminum construction
- Durable blue anodized finish with laser engraved markings
- Not for use in breaking rivet master links
- Original Motion Pro Design

682748

MOTION PRO SLACKSETTER PRO™



- Accurately and quickly measures chain slack
- Two scales measure both chain slack and chain to swingarm clearance in millimeters
- Setting chain slack properly dramatically improves chain life
- Light weight compact design fits easily in your tool box or road kit
- Works on most street and dirt bike applications up to 75mm chain slack
- Made from engineered nylon with aluminum measuring scale
- Anodized laser etched precision measuring scale
- Refer to your owner's manual for proper chain slack and procedure
- Does not work on motorcycles with Gullwing type swingarms
- Patented Design

682106

MOTION PRO WYE CONNECTOR 3/16 PK/10



- White fuel-resistant plastic (Acetal)
- Fitting used to run two hoses into one
- May be used with O-Clips or hose clamps
- Sold in packs of 10
- Warning: Not for use with fuel injected engines

142554

MOTION PRO COOLING SYSTEM TESTER, TYPE A ADAPTER



- Type-A adapter is designed to work on radiator necks ranging from 15.75 mm - 20 mm
- Specified range is most commonly found on Japanese manufactured radiators, 2016 and up KTM, and can also be found on some late model water-cooled American V-Twins. Measure your radiator neck to confirm correct size for your application.
- Adapter only

682206



MOTION PRO CLUTCH HOLDING TOOL



- Made from medium carbon steel with hardened jaws
- Hold clutch hubs, flywheels, gears, sprockets, etc.
- Features 8mm spanner pins
- Jaws open up to 5 inches wide
- Recommended for square tooth style clutch hubs
- Not recommended for v-groove or half round style clutch hubs
- Will not work on clutch baskets with reversed inner clutch hubs where the integrated clutch faceplate is facing outward
- Replaces HD tool #HD-91042, Used on 1984 and later 1340cc models and 1984 and earlier XL models

678008

MOTION PRO CHAIN TENSIONER HARDWARE KIT



- Replacement chain tensioner hardware for most stock applications of street and off-road motorcycles
- Metric class (grade) 8.8 for outstanding wear and durability
- Durable zinc plated finish for ultimate corrosion protection
- Kit contains the following class 8.8 hardware:
2 each - M8x50 bolts with 10mm hex head
2 each - M8 flange nuts with 12mm hex head

682810

MOTION PRO ROTOR AND SPROCKET HOLDER



- Keeps flywheels, rotors and sprockets from rotating during removal and installation
- Holds sprockets and rotors with holes center to center at a minimum distance of 13mm and a maximum distance of 230mm
- Features 5 and 9mm pins
- Adjustable stop-screw keeps tool open at set distance

142205

MOTION PRO U-JOINT PRESS TOOL



- Easiest way to service and replace U-Joints
- Floating press plate allows the use of a hammer for stubborn joints
- 16 mm, 22 mm and 27 mm adapters fit most ATV and UTV applications
- 16 mm & 20 mm drive tips made of durable hardened steel
- Laser etched size marking on adapters and tips
- Heavy duty steel construction
- Heat treated for strength and durability
- Durable black oxide coating

682154

MOTION PRO GEAR JAMMER™



- Locks gears in place for easy installation and removal
- Allows tightening lock nuts to proper torque setting
- Works on virtually any motor
- Powerful magnet holds tool in place during use
- Billet 6061 T-6 aluminum construction
- Blue anodized finish with laser engraved Motion Pro logo
- Originally developed for removing and installing the primary gear on a Honda CRF 450
- Not for use with impact guns
- Patented design

142338

MOTION PRO ROCKER BOX WRENCH 3/16" FOR HD



- Designed to reach the hard to get to 3/16" Hex Screw on the rocker boxes of Evo Big Twin, Sportster® & Buell® motorcycles
- Features a 3/8" drive for use with torque wrench
- Vinyl cover offers comfort and minimizes chances of damage to finished surfaces

142158



**MOTION PRO COUNTER
BALANCER & CLUTCH HUB SPANNER FOR HONDA 20MM**



- Equivalent to 20 mm end of Honda OEM tool 07716-0020100
- Used to remove Honda OEM nut 90231-KY4-900
- Premium quality high carbon steel
- Heat treated for strength and durability
- Durable hot black oxide finish
- Inside diameter is 20 mm
- Use with a 3/8" driver
- Use "Search by Vehicle" to determine the proper spanner nut socket for your specific application

142301

**MOTION PRO BIT, D-SHAPE F/
USE WITH 08-0229**



- D-shaped bit, replacement
- Durable nickel pewter finish

142177

**MOTION PRO DELUXE PISTON
PIN PULLER**



- Interchangeable piston adapters
- Made of durable 6061 aluminum
- Fits all piston pins from 13 mm (0.511") to 24 mm (1 inch)
- Works on both full skirt and short skirt (slipper) pistons
- Non marring aluminum pin adapters
- Durable blue anodized finish with laser engraved logo
- Patented Design

142376

**MOTION PRO DOWEL PIN
PULLER SET**



- Kit includes 8 mm, 10 mm, 12 mm, and 14 mm collets
- Puller rod can be used to remove slightly stuck pins
- Slide hammer attachment for severely frozen pins
- Durable hardened steel construction
- Laser etched for easy identification
- Includes handy storage tray to keep pieces organized and ready for use
- Additional dowel pin collet sizes available separately - 08-0707 (21mm), 08-0708 (19mm), 08-0709 (17mm), 08-0710 (13.8mm), 08-0711 (12.5mm)
- Lifetime limited warranty
- Patented Design

682732

**MOTION PRO COOLANT
RECOVERY TANK, 275CC**



- Prevents loss of coolant due to overheating
- Works on most water-cooled motorcycles, snowmobiles, and ATV's
- Designed for hot weather and/or high-altitude riding conditions
- Compact, versatile, high density polyethylene bottle
- Built in mounting holes provide multiple mounting options
- Bottle cap is constructed from chemical-resistant rubber for durability and easy installation/removal
- Includes 275cc bottle, hose, clamps, mounting ties and instructions
- Bottle dimensions: H (w/cap) 5 1/2" x W 3 3/4" X D 1 7/8"

144196



MOTION PRO - PRO SPARK PLUG SOCKET™



- Ultra-strong tool steel construction
- Slim skeleton profile
- Use with a 3/8" square drive or 17 mm wrench
- Innovative internal plug retention system
- Protective black oxide coating
- Easy to read laser etched markings
- Through hole allows use of screwdriver or holding rod
- Light weight
- Lifetime limited warranty
- Patented Design

SIZES	PART #
16mm	144425
18mm	144426
21mm	144427

MOTION PRO SPARK PLUG GAP TOOL



- Ideal tool for checking and setting spark plug gap on almost any spark plug
- Includes 0.5 mm, 0.6 mm, 0.7 mm, 0.8 mm, 0.9 and 1.0 mm gap gauges
- Machined from billet 6061 aluminum
- Includes handy bottle opener
- Durable blue anodizing
- Laser etched markings for easy identification
- Designed by Motion Pro

144362

MOTION PRO REAR WHEEL ALIGNMENT TOOL FOR HD



- For use on Softail, Sportster®, and Dyna®
- Designed to help set rear wheel alignment on models with solid rear axles
- Fast, accurate and easy to use
- Eliminates the need to use a tape measure
- Proper wheel alignment extends chain/sprocket and belt life

142287

MOTION PRO ADJUSTABLE TORQUE WRENCH ADAPTER



- Torque any fastener with a combination wrench or hex wrench
- Will work with most 6 mm through 19 mm metric and most 1/4" through 3/4" SAE wrenches
- Will work with 6 mm to 12 mm and 1/4" to 3/8" hex wrenches
- Tool has clamping range between 6.5 mm and 24 mm
- 3/8" square drive is rated for a maximum torque of 100 lb/ft
- Heat-treated steel with a black oxide finish

142296

MOTION PRO T-HANDLE SET, 7 PC METRIC



- Includes 8mm, 10mm, 12mm, 13mm, 14mm, 17mm & 19mm T-Handles
- Durable nickel pewter finish
- Deep 6-point sockets
- Lifetime limited warranty

142082

MOTION PRO MINI-PRO T-HANDLE SET 8,10,12,13, 14 MM

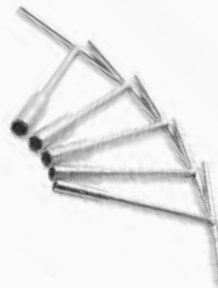

- Five piece set includes 8, 10, 12, 13, and 14 mm sizes
- Compact size for easy access and transport
- 6 3/4" shaft length
- Chrome-vanadium tool steel shaft
- Durable nickel pewter finish
- Lifetime limited warranty

142262



MOTION PRO TAPPET ADJUSTERS



- Allows precise valve lash adjustment without disturbing the setting when the lock nut is fastened
- Knurled knob on adjuster drivers ensure a precise and secure grip
- Integrated repositionable wrench handle holds the lock nut while the drivers are used to loosen or tighten the valve adjustment screw

SIZES	PART #
Tappet Adjuster Set	682237
3mm Sq., w/9mm Socket Wrench	682238
Straight Slot w/10mm Socket Wrench	682239
3mm Sq., w/10mm Socket Wrench	682240

MOTION PRO TIMING PLUG WRENCH



- Fits the straight-slot timing plugs on most motorcycles and ATVs
- Blade sizes are 16mm (5/8"), 22mm (7/8") and 38mm (1 1/2")

678087

MOTION PRO T6 VALVE SPRING COMPRESSOR



- Quick release system presses straight against the retainer to eliminate side loading the valve and keepers
- Works on all motorcycle, ATV, UTV, and small engine cylinder heads
- Billet 6061 aluminum frame provides unmatched strength and stiffness and lower weight
- Fully adjustable top and bottom
- Aluminum lower adjuster will not damage or scratch valves
- Includes two universal fork style tips (24mm and 28mm outside diameter)
- Durable blue anodized finish with laser engraved markings
- Simple, fast, and easy to use

SIZES	PART #
24mm and 18mm Adapter	682752
24mm and 28mm Adapter	682753

MOTION PRO T6 VALVE SPRING COMPRESSOR 18 MM AND 28 MM ADAPTER SET (ADAPTERS ONLY)



- Alternate adapter sizes for the 08-0641 T-6 Valve Spring Compressor
- Kit includes 18mm and 28mm adapters
- Requires use of 08-0641 Valve Spring Compressor, not included

682155

MOTION PRO FUEL INJECTOR CLEANER PIGTAIL FOR HON-F2 INJECTORS, PIGTAIL ONLY



- Fits most oem HON-F2 fuel injectors used on motorcycle engines
- For use with Motion Pro Fuel Injector Cleaner

682738



MOTION PRO 2-STROKE TIMING KIT FOR WATER COOLED ENGINES



- Kit includes a dial indicator with extensions and a 14 mm spark plug thread adapter
- Allows inspection and adjustment of ignition timing
- Scaled in millimeters
- Designed to clear frame tubes on most recent water cooled models
- Gauge face size 1 1/2"
- Due to limited space between the cylinder head and upper frame rails, Two stroke timing kit 08-0250 with adapter kit 08-0249 does not fit on Yamaha RD two stroke twins with the engine installed in the frame. Adapter kit 08-0249 with two stroke timing kit 08-0250 does work on Yamaha RD two stroke twins with engine out of frame.

142189

MOTION PRO T-HANDLE, BALL-END HEX DUAL DRIVE, METRIC SET (4,5,6,8MM)



- Four piece set
- Use T-Handle hex to tighten/loosen fasteners and ball-end hex on shaft for quick installation/removal of fasteners
- Ball end allows for better access to hard to reach socket head hex bolts (up to 25-degree working angle)
- Compact 6 3/4" shaft lengths for tight spaces and easy transport
- Chrome-vanadium tool steel shaft and T-Handle
- Durable nickel pewter finish
- Lifetime Limited Warranty

142299



Kit for ND

682119

MOTION PRO FUEL INJECTOR CLEANER KIT FOR ND

- Easily cleans most fuel injectors
- Fits most oem Nippon Denso fuel injectors used on motorcycle engines
- Will flush and back flush injectors for best possible cleaning process
- No compressed air required
- For best results use Motion Pro Fuel Injector Cleaner 15-0004, it's specifically formulated not to harm O-rings and other fuel injector moving parts
- Push button switch to turn fuel injector on with LED battery condition indicator light
- Durable anodized billet aluminum construction
- Built tough for everyday shop use
- 9 volt battery included
- Patented Design



Pigtail for HYB Injectors

382306

Kit for HYB

382305

MOTION PRO FUEL INJECTOR CLEANER KIT FOR HYB

- Easily cleans most fuel injectors
- Fits most oem HYB fuel injectors used on motorcycle engines
- Will flush and back flush injectors for best possible cleaning process
- No compressed air required
- For best results use Motion Pro Fuel Injector Cleaner 15-0004, it's specifically formulated not to harm O-rings and other fuel injector moving parts
- Push button switch to turn fuel injector on with LED battery condition indicator light
- Durable anodized billet aluminum construction
- Built tough for everyday shop use
- 9 volt battery included
- Patented Design



MOTION PRO FUEL INJECTOR CLEANER KIT FOR EV6



- Easily cleans most fuel injectors
- Fits most EV6 fuel injectors
- Specific model application information available on Motion Pro website
- Will flush and back flush injectors for best possible cleaning process
- No compressed air required
- For best results use Motion Pro Fuel Injector Cleaner 15-0004, it's specifically formulated not to harm O-rings and other fuel injector moving parts
- Push button switch to turn fuel injector on with LED battery condition indicator light
- Durable anodized billet aluminum construction
- Built tough for everyday shop use
- 9 volt battery included
- Patented Design

MOTION PRO FUEL INJECTOR CLEANER KIT FOR EV1



- Easily cleans most fuel injectors
- Fits most EV1 fuel injectors
- Specific model application information available on Motion Pro website
- Will flush and back flush injectors for best possible cleaning process
- No compressed air required
- For best results use Motion Pro Fuel Injector Cleaner 15-0004, it's specifically formulated not to harm O-rings and other fuel injector moving parts
- Push button switch to turn fuel injector on with LED battery condition indicator light
- Durable anodized billet aluminum construction
- Built tough for everyday shop use
- 9 volt battery included
- Patented Design

MOTION PRO FUEL INJECTOR CLEANER KIT FOR HV2



- Easily cleans most fuel injectors
- Fits most oem HV2 fuel injectors used on motorcycle engines
- Will flush and back flush injectors for best possible cleaning process
- No compressed air required
- For best results use Motion Pro Fuel Injector Cleaner 15-0004, it's specifically formulated not to harm O-rings and other fuel injector moving parts
- Push button switch to turn fuel injector on with LED battery condition indicator light
- Durable anodized billet aluminum construction
- Built tough for everyday shop use
- 9 volt battery included
- Patented Design



MOTION PRO MP TOOL METRIC



- A must-have for on-the-trail repairs or adjustments
- Can be used to remove 8, 10, 12 & 14 mm bolts, #2 & #3 Phillips screws, small & medium straight-slot screws and 5 & 6 mm Hex bolts
- Includes a 1/4" and 3/8" socket driver
- 10 mm & 12 mm 1/4" drive sockets included
- Enhance it by adding your own 1/4" or 3/8" drive socket attachments
- Includes convenient carrying case
- Hard nickel pewter finish
- Replacement bits available separately

678030

MOTION PRO MINI-PRO DUAL DRIVE T-HANDLE



- Use T-Handle drive to tighten/loosen fasteners and shaft drive for quick installation/removal of fasteners
- Chrome-vanadium tool steel shaft and T-Handle
- Durable nickel pewter finish
- Lifetime limited warranty

SIZES	PART #
1/4"	142278
3/8"	142279

MOTION PRO DAMPER ROD FORK TOOL



- Aids in assembly and disassembly of most 41, 43, 46 & 47 Kayaba and Showa inverted forks
- Is used in applications where the manufacturer recommends the following tools: Honda; OEM tool # 07PMB-KZ4010A/ Yamaha; OEM tool# YM-01423
- Check your owner's/service manual for the above OEM part number prior to purchasing this tool
- Not required on the 1991 Honda CR models
- Does not fit 1998 and later KYB 46U cartridge forks.
- Hardened steel with black finish

142086

MOTION PRO ADAPTER KIT FOR AIR-COOLED ENGINE



- Kit includes an extended thread adapter and dial indicator extension.
- Allows Water-Cooled 2-Stroke Timing Kit (08-0250) to be used on air cooled engines with 14mm spark plugs.
- Adapter kit does not allow two stroke timing kit 08-0250 to be installed on Yamaha RD two stroke twins when the engine is in the frame. Adapter kit 08-0249 with two stroke timing kit 08-0250 does work with engine out of frame.
- Adapter length installed is 55 mm. Outside diameter is 19 mm.
- Durable anodized aluminum finish

142188

MOTION PRO MOTOSPADE™



- 2-ended design combines brush/pick and a curved spade to help you keep your vehicle clean of mud and debris
- Curved spade helps remove the big stuff
- Brush is ideal for cleaning radiator and controls, the pointed tip helps remove build-up in foot pegs and hard to reach areas
- Ergonomic handle is made from durable ABS plastic
- Built-in hanger hole or compact enough to store in your toolbox
- Patented design

142380

MOTION PRO PEDAL ANCHOR KIT



- Prevents brake pedal from catching on berms, branches, rocks, etc.
- Includes 3 cables, 3 special crimp fittings and 12" of 1/8" clear PVC
- Made in the USA

142495



**MOTION PRO RATCHET/
SOCKET SPARK PLUG WRENCH
KIT 13/16"**



- Designed to fit in limited space on many water-cooled 2-stroke engines
- Ratchet mechanism works one way, turn over to reverse
- Fits standard 13/16" plugs
- Kit includes Ratchet Spark Plug Wrench (08-0147) and 13/16" Extension Socket (08-0291)
- 13/16" Extension Socket (08-0291) allows the 08-0147 Ratchet Spark Plug Wrench to be used on recent models where the water neck prevents the use of the 08-0147 alone

142250

**MOTION PRO TRI-DRIVE
MINI T-HANDLE KIT, 1/4"
W/8,10,12,13 MM SOCKETS**



- Use T-Handle drive to tighten/loosen fasteners and shaft drive for quick installation/removal of fasteners
- 1/4" drive has a compact 6 inch drive shaft length
- Compact size for use in tight spaces and is easy to carry
- Includes 8 mm, 10 mm, 12 mm and 13 mm sockets
- Use with 1/4" drive sockets, hex drives, crowfoot, swivels, etc.
- Chrome-vanadium tool steel shaft and T-Handle
- Durable nickel pewter finish
- Lifetime Limited Warranty

142305

**MOTION PRO ATV AXLE
WRENCH SET, 45.5MM &
56MM**



- Sold as set
- Fits most Honda TRX 250X, 300X, 300EX, 400X, 400EX, 450R, and 450EX
- Made from heat-treated steel
- Includes a 1/2" - drive slot for use with a torque wrench or breaker bar

143455

**MOTION PRO PUSH BOLT FOR
08-0058**



- For riveting hollow nose master links only.
- Versatile enough to be used on cam chains or drive chains
- Will break chains from #35 to #630
- Each kit includes three pin sizes to fit most chains
- Features new and improved investment-cast, hardened body and redesigned body bolt
- Includes press plates P/N 150123
- Recommended for light- to medium-duty use
- For chain 520 and up, it is recommended to grind the rivet head.

143783

**MOTION PRO FITTING SG-145
PK/10**



- Replacement clips
- Sold in packs of 10

140225

**MOTION PRO FITTING BS-1201
PK/10**



- Sold in packs of 10

140227



MOTION PRO SPINNER T-HANDLE II



- Unique 2-step drive head offers swivel or fixed drive
- Low friction bushing mounted spinner provides faster and easier removal and installation of bolts and nuts
- Padded grip handle
- Chrome vanadium handle and shaft
- Durable chrome finish on shaft and handle
- Blue anodized spinner with laser engraved Motion Pro logo
- Lifetime Limited Warranty

SIZES	PART #
1/4" Drive - 8.5in L	682148
3/8" Drive - 12in L	144175

MOTION PRO SPANNER NUT SOCKET



- Used for removal and installation of spanner (castle) lock nuts
- Premium-quality high-carbon steel
- Heat-treated for strength and durability
- Durable hot black oxide finish
- Laser-etched with Motion Pro logo and part number

SIZES	PART #
34mm / 50mm	144178
20mm / 34.5mm	144179

MOTION PRO BPF ROD GUIDE WRENCH



- Used to remove internal rod guide on Showa BPF 41 and 43 mm forks
- The actual size of the tool's hex is 33mm and 35mm
- Black oxide finish
- 43mm side replaces Honda OEM tool 070MB-MGPA100, Kawasaki OEM tool 57001-1758 and Suzuki OEM tool 09940-84710
- 41mm side replaces Honda OEM tool 070MB-MCJ0100, Kawasaki OEM tool 57001-1742 and Suzuki OEM tool 09940-84711

682750

MOTION PRO TORX BIT SET



- Double ended Torx Bits
- Sizes T25/T30 and T40/T45
- Durable nickel pewter finish
- Rubber O-ring keep bits securely in place
- Bits compatible with MP Tool Metric (part no. 08-0161)
- Also fits 1/4" drive by 5/16" socket (part no. 08-0384)

682760

MOTION PRO CABLE ADJUSTER



- Black epoxy finish, die-cast aluminum housing
- Fits any Honda CR type throttle cable with ball end
- Designed for 34mm or smaller carburetors
- High grade steel allen bolts
- Use special Motion Pro cable or Honda CR cable
- Uses 4-1/2 sleeve with grip retaining ring

671018

MOTION PRO CARB. ADJUST SCREW



- It is designed for use with Motion Pro TORS eliminator carb caps on Mikuni carburetors.
- This screw is also included in Motion Pro throttle kits for some Yamaha ATVs.
- The thread size is M6 x 0.75 x 21mm.

671013



MOTION PRO PIN SPANNER WRENCH



- Unique curved billet aluminum arms provide clearance and ease of use
- Stainless steel shoulder bolt pivot
- Replaceable hardened tool steel pins
- Includes 4 mm and 3 mm pins
- Low profile pins provide added clearance on fork caps
- Durable blue anodized finish with laser engraved markings
- Designed for use on many forks and shock absorbers
- For low torque use only
- Original Motion Pro design

144352

MOTION PRO MAGNETIC NUT DRIVER SET



- High quality 9 pc. 1/4 inch hex-drive metric-socket bit set
- Includes sizes 5, 5.5, 6, 7, 8, 9, 10, 12 & 13mm
- Sockets are constructed from Chrome-Vanadium (CR-V) alloy steel for excellent strength and durability
- Magnet inside sockets retains bolt head or nut in socket
- Durable black finish
- Includes convenient holder to keep bits organized
- For use with quick release drivers only
- Not compatible with 08-0556 Spinner T-Handle Bit Driver

144353

MOTION PRO SPANNER NUT SOCKET



- Equivalent to Suzuki tool 09940-14940
- Socket dimensions: 43.2mm OD x 33.15mm ID x 5.25mm Pin Width/4 pins
- Used for removal and installation of spanner (castle) lock nuts
- Premium quality high carbon steel
- Heat treated for strength and durability
- Durable hot black oxide finish
- 1/2 inch drive
- Laser etched with Motion Pro logo and part number
- Lifetime Limited Warranty
- Use "Search by Vehicle" to determine the proper spanner nut socket for your specific application

144354

MOTION PRO CRANKCASE SPLITTER V2



- This new tool from Motion Pro is the fastest and easiest to use case splitter ever devised!
- Unique design makes it easy to center puller over crankshaft
- Grooved puller studs are fast and simple to install
- Captured retaining collars in puller arms allow quick adjustment and set up
- Durable tool steel body with protective black finish
- Billet 6061 aluminum arms with blue anodized finish
- Includes 5, 6 and 8 mm threads on puller studs to fit various engine case sizes
- Includes molded tray for s

144358

MOTION PRO VALVE STEM SEAL INSTALL TOOL SET, 4PC 4, 4.5, 5 & 5.0BUA



- 4pc. set includes three common sizes for use on most modern street bikes, 4.0mm, 4.5mm & 5.0mm and one additional 5.0mm specially designed for the Suzuki Hayabusa and other Suzuki models that use the same seal
- Properly aligns valve stem seal to valve guide so seal snaps on straight every time
- Provides for quick and easy installation of valve stem seals on multi valve cylinders
- Contoured design in bottom of handle cradles and protects the delicate inner lip of the valve stem seal while directing tool force to the sturdy outer rim
- Slim profile allows easy access to valve guides even on modern compact heads with deep lifter bores
- Rounded tip will not damage inner lip of valve stem seal or valve guide bore
- Anodized aluminum handles with stainless steel pilot shafts
- Lifetime Limited Warranty

144281



MOTION PRO TORQUE WRENCH ADAPTER



- Chrome-vanadium tool steel with hard nickel pewter finish
- Properly torque two-stroke cylinder base nuts and hard-to-reach fasteners
- Fits 12 mm and 14 mm nuts and bolts
- Extends the reach of any 3/8 inch drive torque wrench by 3 inches
- Chart supplied for torque conversions
- Check owners manual for proper torque specifications
- Rated for a maximum torque of 75 lb-ft

678134

MOTION PRO RATCHET SPARK PLUG WRENCH



- Designed to fit in limited space on many water-cooled 2-stroke engines
- Ratchet mechanism works one way, turn over to reverse
- Fits standard 13/16 inch plugs (21 mm)
- Optional 13/16 inch Extension Socket (p/n 08-0291) allows the 08-0147 Ratcheting Spark Plug Wrench to be used on recent models where the water neck prevents the use of the 08-0147 alone (sold separately)

678147

MOTION PRO SUPERLIGHT T6 HEX AXLE TOOL



- Fits internal hex axles on many late model sportbike and some off-road bikes
- Four metric hex sizes: 17, 19, 22 and 24 mm
- Made from billet 7075-T6 aluminum
- Weighs only 2.5 oz
- Ideal for touring and trail side use
- 3/8" square drive on both ends rated to 90 lb/ft
- Use wrench on external hex of tool for situations exceeding 90 lb/ft
- Use 08-0397 CrMo steel version for shop use

678355

MOTION PRO MAGNETIC PICK UP TOOL



- Low profile tip fits in tight spaces
- Bendable housing retains its shape to access hard to reach areas
- Powerful magnet
- Protective rubber coating won't scratch aluminum or plastic surfaces
- 18 inches long
- Billet aluminum laser etched handle

682149

MOTION PRO GASKET SCRAPER



- Brass blade included safely removes paper gaskets from aluminum engine cases
- Steel blade included for difficult to remove paper gaskets
- Narrow, angled blades designed specifically for small, thin engine cases
- Convenient blade storage in handle
- Ergonomic billet aluminum handle
- Replacement blades available, Part No. 08-0657
- Patented design

682150

Replacement Blade Set

682742

MOTION PRO HOSE REMOVAL TOOL



- Facilitates removal of fuel, oil and cooling system hoses
- Two tools in one. One end is used to loosen stuck hose, the other end assists in pulling the hose off the fitting
- Reduces the possibility of damage to hoses and related components
- Lock nut at base of both tips allows for removal of either side for use in tight spaces
- Compact aluminum handle provides solid grip and excellent control
- High-quality steel tips with durable black oxide coating
- Designed by Motion Pro

682151



MOTION PRO PUSHROD TOOL FOR HD

- Designed to remove and install the clip on Harley-Davidson® collapsible push rod tubes on Twin Cam and earlier Models
- Flat portion of tool fits under the cylinder head while cupped end fits over the bell in the tube and then compresses the spring allowing for easy access to the spring cap retainer
- No more cut knuckles & scratched engine parts from using a screwdriver between the fins
- New improved design with shoulder bolt pivot for smoothness and durability

682246



MOTION PRO CLIP-ON HANDLEBAR ALIGNMENT TOOL

- Ideal for aftermarket clip-on handlebar installation
- Adjustable arm allows exact position match
- Lightweight 6061 billet aluminum construction
- Collapsible compact design can be stored in almost any toolbox
- Knurled thumb screw
- Designed by Motion Pro

682722

MOTION PRO JIS CROSS POINT 1/4" HEX-DRIVE BIT, SIZE NO.1, (2-PACK)



- Designed to fit JIS cross-head screws commonly found on Japanese bikes
- Made from high grade S2 tool steel
- Hardened for maximum durability
- JIS cross point bits are a must have for most Japanese made bikes and work equally well on traditional Phillips head screws. Use of traditional Phillips driver on JIS cross head screws will damage screw head.

682723



MOTION PRO ERGO SPOKE WRENCH™, SPLINE DRIVE

- Unique combination wrench design has open end and semi-closed end designed to fit spline drive spoke nipples
- Use open end for quick adjustment of spoke nipples and semi-closed end for those hard to turn nipples that require more torque
- Specially designed ergonomic handle allows larger turning radius and excellent grip and feel
- Polished finish with laser engraved logo and size markings
- Lifetime limited warranty
- Patented design

682726

MOTION PRO BARREL NIPPLE (MIN 10)



- Universal Cables & Cable Fittings
- Pack of 10

SIZES	PART #
6 X 10mm for 1.5mm wire	671010
6 X 7mm for 1.5mm wire	671011



MOTION PRO CARB. END NIPPLE - (MIN 10)

- Cable fittings for repairing or custom cable fabrication
- This cable adjuster/adaptor can be used on the MOTION PRO or CR COMPETITION throttles to adapt a standard type cable to a Honda type throttle.
- Throttle nipple, carb end, for 1.5 mm wire.
- Sold in 10-pks.

671012



MOTION PRO HARDWARE KIT, METRIC EURO 54 PIECE SET



- 54 piece assortment of the most popular KTM and Husqvarna style replacement hardware
- Metric grade 8.8 for outstanding wear and durability
- Durable Dacromet coating or zinc plated finish for ultimate corrosion protection
- Perfect size to carry in your tool box or saddle bag
- Kit contains the following items:

- Dacromet Coated
- 4x M6x20 Euro Style Shroud Screw
- 4x M6x12 Euro Style Fork Guard Bolt
- 4x M6x12 Euro Style Torx Hex Head Flange Bolts
- 4x M6x16 Euro Style Torx Hex Head Flange Bolts
- 4x M6x20 Euro Style Torx Hex Head Flange Bolts
- 4x M6x30 Euro Style Torx Hex Head Flange Bolts
- 6x M6x12 Euro Style Torx Hex Head Large Flange Bolts
- 6x M6x20 Euro Style Torx Hex Head Large Flange Bolts
- 3x M5x12 Euro Style Hex Head Flange Bolt
- 4x M8x30 Euro Style 10mm Hex Head Flange Bolts

- Zinc Plated
- 2x M6 Euro Style Convex Washers
- 2x M6x16mm Fender Washer
- 1x M8-1.25 Flange Nut
- 1x M6-1.0 Flange Nut
- 2x M5x10 Pan Head Screw
- 3x Brembo Style Brake Pin Clip

144376



MOTION PRO CABLE BALL FITTINGS - 10/PACK



- (Fittings sold only in package of 10-priced per package) Ball throttle nipple 7/32" for 1.5mm wire.
- For all the custom applications or rare models that standard cables won't fit
- No matter if you're running different carbs, custom bars or low clip-ons, the Motion Pro Cable Fittings offer the most common cable fittings for all your custom or replacement cable jobs

671000

MOTION PRO BARREL NIPPLE



- 5/16 (8x9) for 2mm wire
- Cable fittings for repairing or custom cable fabrication
- This cable adjuster/adaptor can be used on the MOTION PRO or CR COMPETITION throttles to adapt a standard type cable to a Honda type throttle.

671003

MOTION PRO HOUSING END, 7M - (10 PKG)



- Cable fittings for repairing or custom cable fabrication
- This cable adjuster/adaptor can be used on the MOTION PRO or CR COMPETITION throttles to adapt a standard type cable to a Honda type throttle.
- Sold in 10-pks.

671005



**MOTION PRO CARB. ANGLE
ADJ. - (MIN 10)**



- Cable angle screw, Mikuni carb top
- For use with inner wire with nipple size no greater than 3 mm x 3 mm

671014



**MOTION PRO CABLE HOUSING
BLACK - 50'**

- Cable Wire 100' bulk steel cable wire for custom cable fabrication. Cable Housing. Bulk cable housing for custom cable fabrication 50' L.
- Bulk cable housing for custom cable fabrication

SIZES	PART #
7mm OD Black 50' X Roll	671103
5mm OD Black 50' X Roll	671104
6mm OD Black 50' X Roll	671105

**MOTION PRO FORK CAP TOOL
FOR SHOWA SFF, 50MM**



- For removing the fork cap and compression cartridge on Showa SFF forks
- Outer ring fits 50mm octagonal fork cap
- Inner body holds cartridge so it can be removed from fork cap
- Outer ring can be clamped in vise to hold fork cap securely while cartridge is being removed
- Provides more secure grip on fork cap and cartridge and reduces risk of damage during disassembly
- Easier and faster to use than any other tool now available
- Billet 6061 aluminum construction with anodized blue finish
- 1/2" square drive
- Lifetime limited warranty
- Patented design

144180



**MOTION PRO FORK CAP TOOL
FOR SHOWA, 50MM**

- For removing and assembling the fork cap and compression cartridge on twin chamber Showa forks found on late model Honda, Kawasaki, and Suzuki off-road motorcycles (Use SBV function for exact listings)
- Outer ring fits 50 mm octagonal fork cap
- Inner body holds cartridge so it can be removed from fork cap
- Outer ring can be clamped in vise to hold fork cap securely while cartridge is being removed
- Provides more secure grip on fork cap and cartridge and reduces risk of damage during disassembly
- Easier and faster to use than any other tool now available
- Billet 6061 aluminum construction with anodized blue finish
- 1/2" square drive
- Lifetime limited warranty
- Patented design

144177

MOTION PRO STEERING STEM BEARING TOOL FOR HD



- Removes and installs tapered roller bearing OEM #48300-60 at base of steering stem
- Fits most Harley-Davidson® motorcycles with tapered roller bearing at base of steering stem, see application listing for your specific model.
- Durable black oxide finish with laser engraved logo
- Compact design will fit within steering stops on lower triple clamp
- Removes bearing without damaging steering stem
- Bearing driver adapter installs new bearing without damage to bearing or steering stem

144173



METRIC HARDWARE KIT 52 PCS



- 52 piece assortment of the most popular OE style replacement hardware for street and off-road motorcycles and ATV's.
- Metric class (grade) 8.8 for outstanding wear and durability
- Durable zinc plated finish for ultimate corrosion protection
- Perfect size to carry in your tool box or saddle bag
- Kit contains the following items:
 - 4x Flange Bolt M6x1.0x20
 - 8x Flange Bolt M6x1.0x16
 - 4x Flange Bolt M6x1.0x12
 - 4x Flange Bolt M6x1.0x25
 - 4x Flange Bolt M6x1.0x30
 - 2x Flange Bolt M8x1.25x16
 - 2x Flange Bolt M8x1.25x20
 - 4x Phillips Pan-Head Screw M5x0.8x10
 - 2x Flange Nut M6x1.0
 - 2x Flange Nut M8x1.25
 - 6x Fender Washer 6mmx22mm
 - 10x Fender Washer 6mmx16mm

682811

MOTION PRO NITRO TAPE BLACK



- Self-fusing silicone tape that leaves no residue
- Stretches 300%
- Withstands a temperature range of 65 degrees to 500 degreesF
- Insulates 8,000-Volts per layer
- Waterproof
- Resists UV, oil, salt and corrosive chemicals
- Dimensions: 20mm x 1 wide x 10 ft
- roll

144294

MOTION PRO FORK SPRING TOOL FOR HD



- Assists in the disassembly and assembly of springer-type front forks on Harley-Davidson® motorcycles
- Made in the USA

142112

MOTION PRO FORK COMPRESSION VALVE REMOVAL TOOL



- Replaces Yamaha OEM YM-01500 and Honda 07OMB-MENA100
- For removing the compression valve from cartridge
- 19mm hex drive/ 36mm octagon
- Manufactured out of billet 6061 T-6 aluminum Application:
 - Honda: CRF250R 2010 - 2012, CRF450R 2009-2012
 - Kawasaki KX 250F 2011 - 2013, KX 450F 2009-2012
 - Yamaha: YZ 125/250 2005-2017, YZ 250F/450F 2006-2017, YZ250FX 2015-2017, YZ450FX 2016-2017

142290

MOTION PRO SWINGARM/ RISING RATE LINKAGE BEARING INSTALL TOOL



- Designed for installation of the swingarm bearings on late-model Japanese off-road motorcycles
- 200 mm long threaded installation bolt
- Puller draws bearing into the swingarm
- Includes three drivers for use with common bearing sizes
- Kit includes driver sizes I.D. 20 mm / O.D. 26 mm, I.D. 21 mm / O.D. 26 mm & I.D. 22 mm / O.D. 27 mm

142151



MOTION PRO FORK CAP WRENCH, 49MM DUAL CHAMBER



- 49 mm, 8 point box wrench for removing the fork cap (cartridge) on dual chamber closed cartridge forks on late-model Yamaha's
- 12 mm slot for holding the damper rod for removing the rebound bolt. This allows for the removal of the cartridge from the lower fork leg
- Made of billet 6061-T6 and anodized Motion Pro blue
- Laser engraved markings with Motion Pro logo
- Original Motion Pro design

142340

MOTION PRO WHEEL ALIGNMENT TOOL FOR M8 SOFTTAILS



- Innovative tool helps you check rear wheel alignment quickly and easily
- Conveniently use without removal of most exhaust systems
- Correct wheel alignment is essential for safe handling and reduces wear on drive belt and pulley
- Designed for use on 2018 and up M8 Softails®
- Precision stainless steel indicator rod
- Lifetime limited warranty

682763

MOTION PRO T6 COMBO LEVER SET



- Tire spoon with axle nut hex wrench and tire spoon hex wrench for rim lock nut set
- Both levers have perfectly contoured tire lever on one end
- One lever has unique combination stepped 10/12 mm box end wrench on other end for turning rim lock nuts
- Unique no-pinch tip on one lever helps protect inner tube during tire installation
- Made from lightweight forged 7075-T6 aluminum
- Hard anodized finish
- Under 10 inches in length and weigh only 3.5 oz.
- Hex ends for axle nuts are rated for a maximum torque of 90 lb/ft

SIZES	PART #
30 mm, 10/12 mm	682946
30 mm	682948

T6 COMBO LEVER HEX ADAPTER, 30/19/17



- For use with Motion Pro 08-0690 30 mm T6 Combo Lever
- Adapter fits 17 mm and 19 mm axle nuts
- CNC machined aluminum for precise fit and function
- Laser etched markings for hex sizes
- Weighs only 1 oz. (28.5 grams)
- Patented Design

682951

MOTION PRO ARMOR RIM STRIP TAPE



- Ultra tough and durable material protects tubes
- Won't shift or move like rubber rim strips
- Self -adhesive backed for easy no mess installation
- Pre cut hole for valve tube
- Protects inner tube like no other rim strip

SIZES	PART #
21 INCH WHEELS	142540
18 - 19 INCH WHEELS	142541



MOTION PRO FORK CAP SOCKET, WP4CS FORK



- Fits 2014 KTM XC models and all 2013-2016 Husaberg with WP 4860 4CS forks
- For removing and installing LH and RH adjustable fork caps
- Allows you to properly torque the fork cap assemblies during installation
- 19 mm hex head
- Made from billet 6061 T-6 aluminum
- Anodized finish with laser engraving
- Caution: Always wear safety glasses and refer to the fork manufacturer for correct assembly and disassembly procedures.

144184

MOTION PRO SHOCK SPRING COMPRESSOR



- Safely removes the spring on most coilover shocks
- Includes adapters for both clevis and eyelet type shocks
- Clevis inside width is 40mm, Eyelet width is 17mm
- Adapter plates adjust to fit spring retaining collars from 56 mm to 96 mm
- Innovative, compact, easy to use design
- Low friction radial thrust bearing
- Lifetime limited warranty

144359

MOTION PRO NITROGEN NEEDLE KIT



- Nitrogen needle is used to fill shocks with self-sealing rubber valve (Some Yamaha, Fox & Ohlins)
- Can be used in conjunction with our Nitrogen Shock Gauge (08-0072)
- Instructions included
- Made in the USA

670075

MOTION PRO MICRO BLEEDER™, WP AER



- For use on WP AER48 inverted forks with one each M4 x 0.7 and M8 x 1.0 air bleed screws in the fork caps
- New ultra-compact, low profile design is only 11 mm high installed
- Stainless steel body is stronger and will not corrode
- Easy to install, simply replace the OEM bleeder screw with the Micro Bleeder
- Reduces harshness caused by air build-up
- Allows bleeding of air pressure without tools
- One of the easiest bolt-on upgrades you can make to your forks
- Kit includes two bleeder valves

682116

MOTION PRO SAG SCALE II



- New and improved version of the original Motion Pro Folding Sag Scale
- Can be used to check front or rear sag
- New swing out design is compact and fits in most tool boxes
- Adjustable zero set point for direct scale reading (no subtracting required)
- Cone shaped axle locating pin fits hollow axles up to 20mm with repeatable precision
- 0-120mm measurement scales in 1mm increments
- Reversible multi-scale design accommodates most mini and full size motorcycles
- Made from 6061-T6 aluminum with durable blue anodized finish and laser engraved markings
- Extended length 28 3/8" (720 mm)
- Folded length 15 3/4" (400 mm)
- Designed by Motion Pro
- Replacement axle cone and screw assembly available, Motion Pro Part No. C08-0613A

682117



MOTION PRO FORK CAP WRENCH - 46MM / 50MM

- For removing the caps on Showa MX Forks
- One end is 46mm, the other is 50mm
- Can be used for removal of the compression stack
- CNC machined for precise fit and tolerance
- 6061 aluminum material is non-marring on fork caps
- See Search by Vehicle for model applications

682133



MOTION PRO 22MM SHOWA SFF AIR FORK HEX TOOL

- Removes the lower sealing bolt from Showa SFF Air Fork
- Nonmarking 6061 billet aluminum construction
- Anodized finish

682731



MOTION PRO AMERICAN V-TWIN STEERING RACE TOOL

- 2-In-1 Design quickly and precisely removes and installs outer bearing race from the steering head without the use of a hammer and punch
- Puller design ensures bearing is pulled perfectly straight to eliminate possible damage to frame
- Precision machined anodized aluminum cup will not damage frame
- Utilizes brass thrust washer for easy use and long life
- Hardened steel puller jaws engage securely on inner bearing lip for race removal
- Hardened steel driver precisely fits tapered bearing race during installation
- Works on most Harley Davidson Dyna's, FXR's and early model Baggers, will not work on most Softails and 2014 and up Baggers
- Lifetime limited warranty

682737



MOTION PRO FORK CAP WRENCH, 50MM/14MM

- For use on Showa 49mm Twin Chamber MX Forks
- 50mm, 8-point box wrench for removing fork cap
- 6-point box wrench for removing base valve from cartridge
- 14 mm slot for holding the damper rod for removing the rebound bolt. This allows for the removal of the cartridge from the lower fork leg
- CNC machined for precise fit and tolerance
- Constructed of 6061-T6 aluminum material that is non-marring on fork caps
- Durable blue anodized finish with laser engraved markings
- See Search by Vehicle on Motionpro.com for model applications

682754



MOTION PRO HD FORK CAP SOCKET, 41MM

- Used in the removal and installation of fork caps on 1948 and later Wide Glide models
- Reduces the risk of damage to the fork caps during removal and installation
- 1/2 inch square drive
- Machined from 6061-T6 aluminum with durable blue anodizing and laser engraved markings

682962



MOTION PRO SPOON TIRE IRON SET OF 2

- Curved end fits securely in the hand
- Hard nickel pewter finish
- Each lever is 10 inches long and weighs 71 ounces
- Width at spoon is 25 mm

142320



MOTION PRO STEERING BEARING INSTALLER



- Fits tapered steering bearings 41-42 mm, 47-48 mm, 51-52 mm and 55-56 mm
- Innovative double sided drivers
- Safely installs tapered bearing races in motorcycles and ATV frame
- Made of durable 6061-T6 anodized aluminum and hardened tool steel
- Precision brass thrust bearing for increased durability and smooth operation
- Quick adjustment slotted puller rod for quick installation
- Works on all frames with head tube between 100 mm to 240 mm in length
- Laser etched drivers for easy identification

682310

MOTION PRO FORK CAP WRENCH - 50MM WP



- Box wrench for removing the fork cap (cartridge) on WP 4860 MXMA dual chamber closed cartridge (WP USD 48 mm) forks on late-model KTM's
- Precision 50 mm six-point hex. Protects fork cap from damage during removal and installation
- 12 mm slot for holding the damper rod for removing the rebound bolt. This allows for the removal of the cartridge from the lower fork leg
- Made from billet 6061-T6 and anodized Motion Pro blue
- Laser engraved markings with Motion Pro logo

682950

MOTION PRO HD FORK CAP SOCKET, 39MM



- Use for removal and installation of the fork cap nut (1 3/8" hex)
- Fits most Big Twin® and Sportster® models
- Thin socket measures only 9/32" deep by 5/8" tall
- O-ring insert to help protect the top of the cap
- 1/2 inch square drive
- Machined from 6061-T6 aluminum with durable blue anodizing and laser engraved markings

682963

MOTION PRO HD 49MM FORK CAP HEX TOOL



- Used in the removal and installation of fork caps on HD touring models with 49 mm forks
- Protective O-ring reduces the risk of damage to the fork caps during removal and installation
- 1/2 inch square drive
- Machined from 6061-T6 aluminum with durable blue anodizing and laser engraved markings

682961

MOTION PRO ERGO SPOKE WRENCH™



- Unique combination wrench design has 3-sided open end and semi-closed end
- Use open end for quick adjustment of spoke nipples and semi-closed end for those hard to turn nipples that require more torque
- Specially designed ergonomic handle allows larger turning radius and excellent grip and feel
- Polished finish with laser engraved logo and size markings
- Lifetime Limited Warranty
- Patented design

SIZES	PART #
5.0 mm	143836
6.0 mm	143837
6.5 mm	143839
6.8 mm	143840
7.0 mm	143841
6 pc set	143842



**MOTION PRO SHOCKSETTER™
14MM**

- Quickly and easily adjusts rear shock compression and rebound
- Portable design allows for convenient trackside or trailside adjustments
- Fits common 12mm and 14mm and 17mm high speed compression adjusters
- Made from durable stainless steel and anodized 6061-T6 aluminum

682965

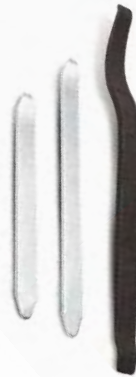

**MOTION PRO TIRE IRON SET 8
IN, 11 IN, 16 IN**

- Includes one 8 1/2 inch tire iron, one 11 inch tire iron and one 16 inch double compound curved tire iron

142047



MOTION PRO SPOON TIRE IRON

- Curved end fits securely in the hand
- Hard nickel pewter finish
- 10 inches long and weighs 7.1 oz.
- Width at spoon is 25mm
- Recommended by top tire changers

142084



**MOTION PRO ENDURO PRO
TIRE IRON PR**

- Hot-forged chrome-vanadium tool steel
- Designed for the professional I.S.D.E rider as well as the Off-Road weekend warrior
- 8 1/2 inches long and weighs just 4 1/2 oz
- Slender curve
- Sold as a pair

142048



**MOTION PRO RIM
PROTECTORS**

- Protects your wheel from scratches and dings caused by tire changing tools
- Retrieval cords are included for easy use
- Made with new and improved nylon material that is tougher, stronger, and more flexible
- Replaces HD tool #HD-1289
- For even more protection and faster tire changes on rims that are 18" or larger, check out our new RimShield II (p/n 08-0546) with its unique design that protects rims and makes changing tires a lot easier

142276



**STEERING STEM BEARING TOOL
FOR '14 AND UP BAGGER**

- Fits 2014 and later Harley-Davidson® touring models
- Removes and installs tapered roller bearings on both steering stems
- Compact design will fit within steering stops on lower triple clamp
- Removes bearing without damaging steering stem
- Bearing driver adapter installs new bearing without damage to bearing or steering stem
- Constructed of heat-treated alloy steel
- Durable black oxide finish with laser engraved logo

682747



MOTION PRO RIMSHIELD™ II



- Designed to protect wheels from damage during tire removal and installation
- Made with genuine DuPont™ Zytel® Super Tough nylon resin for unmatched strength and durability
- Integrated channel design helps guide tire iron and prevents slipping
- Won't mar wheels
- Finger holes make it easy to insert and remove
- Long apron protects hands and spokes
- Sold in set of 2
- Not for use on HD cast rims. Use P/N 08-0357 for HD cast rims
- Patented design

144100

MOTION PRO CLASSIC SPOKE WRENCH SET



- 3 pc., 6/6.3, 6.5/6.8 & 5.0/7.0mm
- 3 piece set of classic combination size spoke wrenches
- Chrome-vanadium tool steel with a hard nickel pewter finish
- Square-end openings which grip the spoke nipple on all four sides
- Offset slotted ends make it easy and quick to use

144285

MOTION PRO TIRE IRON CURVED - 15 INCH



- Cold forged steel
- 15 inch long double-compound-curved tire iron
- Sold individually

6780007

MOTION PRO NEEDLE, N2 FILLER 22 GA. X 1"



- For use with Motion Pro shock filler only

142383

MOTION PRO DIGITAL TIRE PRESSURE GAUGE 60 PSI



- New valve provides higher flow rate and features larger, ergonomically shaped bleeder button for precise pressure adjustment and ease of use
- High precision, accurate to +/- 0.6 psi
- Precise digital readout to 0.1 psi
- Continuous pressure reading, no need to reset when activating bleed valve
- Four selectable scales (PSI, BAR, KG-CM2, kPa)
- Large easy to read display with back light for low light applications
- Billet aluminum trapezoid body
- Billet aluminum air chuck provides tight, leak free seal to tire valve and is specially designed for reading air pressure
- 15 inch long high pressure hose with dual swivels and Motion Pro design air chuck
- Heavy duty anti-shock protective rubber boot on gauge
- Battery powered (1000 tests) with battery strength indicator
- Auto off to extend the battery life
- Batteries not included (Needs Qty. 2 AAA size)
- Two year limited warranty

682874



**MOTION PRO - PRO AIR™
GAUGE CHUCK**



- Specifically designed for use with air pressure gauges to measure tire pressure without leakage that causes imprecise readings.
- Billet aluminum construction for light weight and precise fit and function.
- 1/4" NPT female inlet allows use of common air hose couplings and fittings found on Motion Pro tire pressure gauges and many other tire pressure gauges.
- Blue anodized finish with laser engraved Motion Pro logo.
- Perfect complement for Motion Pro air gauges.
- Not for use to add air or fill tires.

682123

**MOTION PRO T6 COMBO LEVER
10/12MM**



- Perfectly contoured tire spoon on one end
- Unique No-Pinch lip on tire spoon is designed to avoid tube pinch when installing tires
- Unique combination stepped 10/12 mm box end wrench on other end for turning rim lock nuts
- Lightweight forged 7075-T6 aluminum
- Hard anodized finish
- Under 10 inches in length and weigh only 3.5 oz.
- Hex end is rated for a maximum torque of 50 lb/ft

144360

MOTION PRO - PRO FILL™ AIR CHUCK



- New head design provides easier angle adjustment and keeps head oriented in its adjusted position during use
- New O-ring sealing system and thrust washer provides reliable airtight seal
- Stainless steel banjo pivot bolt provides durable performance
- Pivoting angled head design allows access to difficult to reach tire valves
- Unique design provides added hand clearance between filler and hot brake rotors
- Billet aluminum construction for light weight and precise fit and function
- 1/4 inch NPT female inlet allows use of common air hose couplings and fittings
- Blue anodized finish with laser engraved Motion Pro logo
- Perfect complement for Motion Pro air gauges and compressed air systems
- US Patent No. 9,649,898
- Lifetime limited warranty

144357

**MOTION PRO ADAPTER, CARB.
TOP (MIN 10)**



- Carburetor top adapter, fits Mikuni throttle cable to late type Honda carburetor

671019

**MOTION PRO NITROGEN
TRANSFER HOSE 6 FT**



- Is a 6-foot universal hose for transferring nitrogen, a product that is well-crafted from industry-leading materials by Motion Pro, known for its racing experience and high-quality tools. It is a standard nitrogen transfer hose, likely intended for applications in the powersports or automotive industry, designed for reliable performance.

142324



MOTION PRO SYNCPRO™ CARB TUNER



- Precise four channel vacuum indicator designed specifically for intake synchronization of engines with multiple carburetors or throttle bodies (maximum vacuum rating for this tool is 40cm Hg)
- Mercury-free design
- For use with any 2, 3 or 4 cylinder four stroke motorcycles
- Spill proof design allows tool to be stored in a horizontal or vertical position
- Easy to read scale for precise synchronization
- Unaffected by ambient pressure changes
- Includes hang hook to clip onto the handlebars for easy use
- Rugged, impact resistant ABS enclosure with convenient storage area for adapters
- Rubber feet on enclosure bottom helps prevent sliding
- Includes hoses, 5mm adapters, in-line restrictors and instructions
- 5mm adapters are used on many Honda and Suzuki models
- Optional 6mm adapters are available for use on most Yamaha models
- Most Kawasaki models do not need adapters
- Patented design

678411

MOTION PRO SYNC PRO CARB TUNER BRASS ADAPTERS



- Precise four-channel vacuum indicator designed specifically for intake synchronization of engines with multiple carburetors or throttle bodies
- Mercury-free design
- For use with any two-, three- or four-cylinder 4-stroke engines
- Spill-proof design means the tool can be stored in a horizontal or vertical position
- Easy-to-read scale for precise synchronization
- Unaffected by barometric pressure changes
- Includes hang hook to clip onto the handlebars for easy use
- Rugged, impact-resistant ABS enclosure with convenient storage area for adapters, etc.
- Rubber feet on enclosure bottom help prevent sliding
- 5mm adapters are used on many Honda and Suzuki models
- Optional 6mm adapters are available for use on most Yamaha models
- Most Kawasaki models do not need adapters

SIZES	PART #
6MM	678040
5MM - 4/PACK	142021

MOTION PRO SYNCPRO™ FLUID REFILL



- Manometer fluid refill for 08-0411 SyncPro™ Carb Tuner
- Proprietary petroleum-based mineral oil blend
- Mercury free
- Motion Pro blue color
- Bottle contains approximately 6 ml of fluid
- SyncPro™ Manometer Fluid Refill does NOT work with older Motion Pro mercury carburetor synchronizers

678415



MOTORSPORT PRODUCTS ENGINE STAND OFF-ROAD

Engine Stand can be used with almost all vertical-type single cylinder 2- or 4-stroke motorcycle engines; Frame assembles quickly with no tools and breaks down in just seconds for compact storage Swing frame allows engine to tilt to 8 different angles, allowing engine to be at the correct position for any job Spring loaded quick-lock pin adjusts tilt angle with engine mounted Engine will mount to either side of the swing frame for access to the right or left side of engine Engine is secured to stand with a t-handle lock down tool Front engine mount arm can be adjusted to fit a variety of engines using four different adjustment holes on the swing frame Comes with removable oil drip pan, which slides out of either side for easy cleaning Grab handle slots on each side for moving the stand with engine mounted Black and gray powdercoat finish Note: Will not work with lay-down engines/horizontal cylinders

556008

MOTORSPORT PRODUCTS OIL TUB BLACK



- Designed to work with Motorsport Products stands, including the Pro Panel, Diamond Moto and X-Stand.
- Easy-Clean Smooth Smoked Black finish.
- Carry handle and no-drip pour spout for quick pouring
- Holds 3qts.

556177



MOTORSPORT PRODUCTS HANDLE JUG ADVOCATE

- Nylon 1-1/2" tie-down webbing strap wraps around the lower portion of a 5-gallon cans
- Tight fit by use of a loop ring on one end and hook-in-loop sewn on the other end
- Sewn-in grab handle gives you an extra control at the bottom of the can to control pouring
- Lift and control heavy 5-gallon jugs

556179



MOTORSPORT PRODUCTS TOOL T-HANDLE COMBO



- Seven T-Handle Set
- Kit comes with 8mm, 10mm, 12mm, 14mm, and 17mm deep-wall, six-point metric sockets, plus a #2 and #3 cross tip Phillips drivers
- Quality mechanics' tools made of chrome vanadium plated steel alloy for maximum product strength
- Electroplated bright chrome finish keeps them from corroding and gives them a shiny, long-lasting appearance
- Set comes with a heavy-duty reusable vinyl pouch to keep your T-handles together and organized
- Great for shop, home, or use at the track

556002



MOTORSPORT PRODUCTS TIRE IRON 10" SPOON

- Spoon-Shaped Tire Iron Levers
- Made of hardened carbon steel, heat-treated
- Spoon-shape helps prevent pinching of tube
- Rubber-coated handle allows for a firm grip
- Silver zinc for long-lasting finish
- Available in two sizes
- Come in a reusable vinyl package
- Sold as each

556004



MOTORSPORT PRODUCTS TIRE IRON 13.5" SPOON



- Made of hardened carbon steel, heat treated
- Spoon-shaped helps prevent pinching of tube
- Rubber coated handle allows for a firm grip
- Silver zinc for long lasting finish
- Available in two sizes
- Come in a reusable vinyl package
- Sold each

556005

MOTORSPORT PRODUCTS TIRE IRON 15" CURVED



- Made of hardened carbon steel, heat treated
- 15in. dual purpose lever curved shaped on one end and straight on the opposite end
- Black oxide coated for a long lasting finish
- Comes in a reusable vinyl package
- Sold as each

556006

MOTORSPORT PRODUCTS TIRE IRON 16" STRAIGHT



- Multi-use lever - flat spoon shaped end and a narrow hooked-shape end
- Heat-treated carbon steel
- Long lasting zinc finish
- Reusable vinyl package
- Sold each

556007

MOTORSPORT PRODUCTS SHORT PORTABLE TIRE CHANGER



- Holds wheel in place during tire change
- Makes changing tires an easier job
- Compatible with wheels from 17" and up
- Breaks down for easy storage
- Great for trackside or shop use

556009

MOTORSPORT PRODUCTS CHANGER TIRE PORTABLE (TALL)



- Change tires at a comfortable work height. Great for trackside or shop use, you can change tires at a comfortable work height. Holds wheel in place during tire change and makes changing tires an easier job. Comes with a reducer mini-ring for changing smaller tires.
- Holds wheel in place & helps make tire changing a lot easier
- Quick-pins allow for fast, tool-less assembly
- Accommodates wheel sizes from 10" – 21"
- Use reducer ring included for wheel sizes from 10" – 14"
- Openings in both rings allow for better access to rim locks and valve stems
- Pry point area for rim locks located directly below large ring opening
- Storage area incorporated for tire irons
- Extra wide 4 ft. base for maximum stability
- Center threaded rod has different sizes on each end to accept wheel bearings of all sizes
- Two different size wing-nuts included to fit each end of the threaded rod to help secure wheel
- Breaks down to a compact size for easy storage & transportation
- Frame is powder-coated black and all hardware is zinc-plated for long lasting durability

556011



MOTORSPORT PRODUCTS TIRE CHANGER - BEAD BREAKER



- Tire Changing Stand with Bead Breaker
- Makes tire changing a breeze
- Great for shop or portable enough for track use
- Fits most motorcycle wheels from 16" to 21" in diameter
- Heavy-duty steel construction, long handle for maximum force for breaking the toughest beads
- Solid wide base makes for solid foundation during use
- Rubber-coated top ring helps protect wheel from scratching
- Adjustable bead popper
- Black powder-coated finish and zinc-plated for years of use
- Center post with wing nut keeps rim locked down during procedure

556010





**TIRE REPAIR AND
MAINTENANCE KIT**



- 8 pcs chrome hex valve caps
- 8 pcs high temp valve cores
- 2 pcs each long rubber tire valves and short rubber tire valves
- 8 pcs each plastic valve caps and plastic valve extensions.
- 1 pc each valve core remover, tire chuck and dual foot tire pressure gauge
- 20 pcs tubeless tire repair plugs
- 1 pc each ergonomic grip reamer and ergonomic grip plugger
- For patching, 1 tube rubber cement, 1pc metal scuffer, 2pcs rectangular patches, 2 pcs large round patches and 15pcs small round patches

260000

35 PC TIRE HARDWARE KIT



- 4pcs chrome hex valve caps
- 4pcs high temp valve cores
- 4pcs plastic valve stems
- 1pc 4 way valve tool
- 1pc tire pressure gauge
- 1pc rubber cement tube
- 1pc metal scuffer
- 10pcs round patches
- 3pcs tubeless tire repair plugs
- 1pc reamer
- 1pc plugger

260001



**TUBELESS TIRE REPLACEMENT
PLUGS**

- Repair punctures in tubeless tires with these 4-inch tire plugs.
- 4" long tire repair plugs.



QTY	PART #
30 PK	260003
5 PK	260004

12V COMPACT TIRE INFLATOR



- Plugs into 12-Volt Accessory Outlet
- Includes Two Nozzle Adapters and Sport Needle
- Great for Tires, Toys and Sporting Goods
- 10 Ft. Power Cord
- 18 in. Hose Length with Universal Valve Adapter
- Handy on/off switch
- Easy to read pressure gauge
- High output 250 PSI motor

260006

MINI TIRE INFLATOR



- 100 PSI high pressure air compressor inflates standard car tire in under 8 minutes
- Compact size for easy storage with convenient storage compartment.
- 9' power cord with fused 12V power plug
- 12V power cord plugs into vehicle power outlet
- Built in dial pressure gauge
- Accessories include sports ball needle, raft and toy inflator nozzles and Presta valve adapter
- 17.5" high pressure hose

260007

TIRE INFLATOR W/LED



- 100 PSI high pressure
- air compressor
- Large easy to read built in dial pressure gauge
- 3 Super bright LEDs for night time emergencies
- 15" high pressure hose with screw on chuck
- 10' power cord with fused 12V power plug
- 12V power cord plugs into vehicle power outlet
- Inflates standard car tire in under 4 minutes (Performance based upon 175/70 R13 tire to 30 PSI)
- Accessories include sports ball needle, raft and toy inflator nozzles and Presta valve adapter

260008

4 LB SLEDGE HAMMER



- Heavy duty fiberglass handles for strength and durability
- Anti-shock, rubber cushion grips
- Mirror polish heads

260009

3 PC LOCK GRIP PLIERS SET



- Drop forged steel construction
- Hardened and tempered milled teeth
- Wire cutters and quick release levers
- Includes three popular sizes - 5", 7" and 10"

260010

9-1/2" GROOVE JOINT PLIERS



- Drop forged steel
- Cushion grips
- Fully polished head

260011

16 OZ BALL PEIN HAMMER



- Drop forged high carbon steel head
- Heavy duty hardwood handle

260012



RUBBER MALLET

- Rubber head
- Tubular chrome plated handle
- Rubber grip for comfort
- Many uses around home and shop

SIZES	PART #
16 OZ	260013
8 OZ	260014



10 PC SAE HEX BIT SOCKET SET

- Chrome vanadium steel construction
- Heat treated for strength
- Bonus storage rail included
- SAE sizes: 3/32", 7/64", 1/8", 9/64", 5/32", 3/16", 7/32", 1/4", 5/16" and 3/8"

260015



10 PC MET HEX BIT SOCKET SET

- Chrome vanadium steel construction
- Heat treated for strength
- Bonus storage rail included
- Metric sizes: 2, 3, 4, 5, 5.5, 6, 7, 8, 9 and 10mm

260016



FOLDING LB UTILITY KNIFE

- Strength of a fixed blade w/convenience of pocket knife
- Change blades with the push of a button
- Compact design folds down to 3 9/16" for easy storage & portability
- Blade locks in open position for safety
- Handy belt clip
- Available in red or blue handle

COLORS	PART #
RED	260017
BLUE	260018



3 PC PRY BAR SET

- Curved blade design provides extra leverage
- Capped ends allow user to strike with a hammer without damaging the head
- Blade protection for added safety
- Sizes: 8", 12" and 17-3/4"

260020



5 PC SP SOCKET SET

- Recessed edges.
- Socket openings are designed to reduce fastener rounding.
- Chrome vanadium alloy steel construction for strength and durability.
- Polished nickel chrome plated finish resists corrosion.
- Large stamping for quick identification.
- SAE Sizes: 5/8, 3/4 and 13/16".
- Metric Sizes: 14 and 18mm.
- Spark Plug Sockets

260021

9 PC 1/2" DR SAE SOCKET SET



- Recessed edges.
- Socket openings are designed to reduce fastener rounding.
- Chrome vanadium alloy steel construction for strength and durability.
- Polished nickel chrome plated finish resists corrosion.
- 6pt std. Sizes: 1/2, 9/16, 5/8, 11/16, 3/4, 13/16, 7/8, 15/16 and 1".

260022



1/2" DR. 15" FLEX HANDLE

- Chrome vanadium alloy steel construction for strength and durability.
- Polished nickel chrome plated finish resists corrosion.
- 15" Length.

260024

3/8" F X 1/2" M ADAPTER



- Chrome vanadium alloy steel construction for strength and durability.
- Polished nickel chrome plated finish resists corrosion.

260048



3 PC 1/2" DR EXTENSION SET

- Chrome vanadium alloy steel construction for strength and durability.
- Polished nickel chrome plated finish resists corrosion.
- Sizes: 3, 5 and 10".

260026

3 PC 1/2" DR WOBBLE EXT SET



- Chrome vanadium alloy steel construction for strength and durability
- Polished nickel chrome plated finish resists corrosion
- Increased angle flexibility
- Sizes: 3", 5" and 10"

260027



3/8" F X 1/2" M ADAPTER

- Chrome vanadium alloy steel construction for strength and durability
- Polished nickel chrome plated finish resists corrosion

260028



9 PC 1/2" DR MET SOCKET SET

- Recessed edges
- Socket openings are designed to reduce fastener rounding
- Chrome vanadium alloy steel construction for strength and durability
- Polished nickel chrome plated finish resists corrosion
- 6pt std. sizes: 12, 13, 14, 15, 16, 17, 18, 19 and 22mm

260029



8 PC 1/2" DR SAE DW SOCKET SET

- Recessed edges
- Chrome vanadium alloy steel construction for strength and durability
- Polished nickel chrome plated finish resists corrosion
- Large stamping for quick identification
- 6pt deep sizes: 1/2", 9/16", 5/8", 11/16", 3/4", 13/16", 7/8", and 15/16"

260030



DR SOCKET RAIL

- 18" overall length.
- Holds 14 sockets.

SIZES	PART #
1/4"	260032
3/8"	260042



DR QR TEARDROP RATCHET

- Quick Release feature for quick and easy socket changes.
- Chrome vanadium alloy steel construction for strength and durability.
- Polished nickel chrome plated finish resists corrosion.
- 72 gear teeth.
- Larger gear teeth for higher torque and added gear strength.

SIZES	PART #
1/2"	260023
1/4"	260034
3/8"	260044



1/4" DR UNIVERSAL JOINT

- Chrome vanadium alloy steel construction for strength and durability
- Polished nickel chrome plated finish resists corrosion

260035



1/4" F X 3/8" M ADAPTER

- Chrome vanadium alloy steel construction for strength and durability
- Polished nickel chrome plated finish resists corrosion

260036

10 PC 1/4" DR 6 PT MET SOCKET SET



- Recessed edges
- Socket openings are designed to reduce fastener rounding
- Chrome vanadium alloy steel construction for strength and durability
- Polished nickel chrome plated finish resists corrosion
- Large stamping for quick identification
- Packaged on plastic slide rail for storage
- Sizes: 4, 5, 6, 7, 8, 9, 10, 11, 12, and 13mm

260037

10 PC 1/4" DR 6 PT SAE DW SOCKET SET



- Recessed edges
- Socket openings are designed to reduce fastener rounding
- Chrome vanadium alloy steel construction for strength and durability
- Polished nickel chrome plated finish resists corrosion
- Large stamping for quick identification
- Packaged on plastic slide rail for storage
- Sizes: 5/32", 3/16", 7/32", 1/4", 9/32", 5/16", 11/32", 3/8", 7/16" and 1/2"

260038

36 PC 1/4" DR MECHANIC'S SET



36-piece mechanic's socket set featuring chrome vanadium steel construction. Features a high torque quick release ratchet.

- Socket openings are designed to reduce fastener rounding
- Chrome vanadium alloy steel construction for strength and durability
- Polished nickel chrome plated finish resists corrosion
- Features high torque quick release ratchet with 108 gear teeth for 3.3 degree sweep
- Smaller head for tight areas
- 1.4 in. Dr. spinner handle, universal joint and 3 in. extension bar
- (10) standard SAE socket sizes: 5/32, 3/16, 7/32, 1/4, 9/32, 5/16, 11/32, 3/8, 7/16 and 1/2 in.
- (6) Deep SAE socket sizes: 7/32, 1/4, 5/16, 3/8, 7/16 and 1/2 in.
- (10)c standard MM socket sizes: 4, 5, 6, 7, 8, 9, 10, 11, 12 and 13 mm
- (6) Deep MM socket sizes: 4, 6, 7, 8, 10 and 12 mm

260040

3 PC 1/4" DR EXTENSION SET



- Chrome vanadium alloy steel construction for strength and durability
- Polished nickel chrome plated finish resists corrosion
- Sizes: 2", 3" and 6"

260041

4 PC 3/8" DR EXTENSION SET



- Chrome vanadium alloy steel construction for strength and durability.
- Polished nickel chrome plated finish resists corrosion.
- Lifetime warranty.
- Sizes: 1-3/4in., 3in., 6in. and 8in.

260046



3 PC 3/8" DR. WOBBLE EXTENSION SET

- Chrome vanadium alloy steel construction for strength and durability.
- Polished nickel chrome plated finish resists corrosion.
- Sizes: 1 3/4, 3 and 8".
- Warranty: Lifetime

260047



3/8" F X 1/4" M ADAPTER

- Chrome vanadium alloy steel construction for strength and durability
- Polished nickel chrome plated finish resists corrosion

260049



3/8" DR. 13/16" SPARK PLUG SOCKET

- Recessed edges.
- Socket openings are designed to reduce fastener rounding.
- Chrome vanadium alloy steel construction for strength and durability.
- Polished nickel chrome plated finish resists corrosion.
- Large stamping for quick identification.
- Overall socket length: 3 5/16".
- Spark Plug Socket

260051



10 PC. 3/8 IN. DR. METRIC SOCKET SET

- Packaged on plastic slide rail for storage
- Recessed edges
- Socket openings are designed to reduce fastener rounding
- Chrome vanadium alloy steel construction for strength and durability
- Polished nickel chrome plated finish resists corrosion
- Sizes: 10, 11, 12, 13, 14, 15, 16, 17, 18 and 19 mm

260052



10 PC. 3/8 IN. DR. SAE DW SOCKET SET

- Packaged on plastic slide rail for storage
- Recessed edges
- Socket openings are designed to reduce fastener rounding
- Chrome vanadium alloy steel construction for strength and durability
- Polished nickel chrome plated finish resists corrosion.
- Deep sizes: 3/8", 7/16", 1/2", 9/16", 5/8", 11/16", 3/4", 13/16", 7/8" and 15/16"

260053



3/8" DR. 5/8" SPARK PLUG SOCKET

- U-Joint for accessing hard to reach spark plugs
- Recessed edges.
- Socket openings are designed to reduce fastener rounding.
- Chrome vanadium alloy steel construction for strength and durability.
- Polished nickel chrome plated finish resists corrosion.
- Large stamping for quick identification.
- Overall socket length: 3 1/4".
- Spark Plug Socket

260050

10 PC 3/8" DR MET DW SOCKET SET



- Packaged on plastic slide rail for storage
- Recessed edges
- Socket openings are designed to reduce fastener rounding
- Chrome vanadium alloy steel construction for strength and durability
- Polished nickel chrome plated finish resists corrosion
- Sizes: 10, 11, 12, 13, 14, 15, 16, 17, 18 and 19mm

260055

MINI MULTI TOOL W/MERCH STRIP



- Stainless steel 12 in 1 multi-tool
- Features spring loaded plier jaws, wire cutters, slotted and Phillip screwdrivers, knife blades, bottle opener, nail file and more
- Lightweight and durable anodized aluminum handles
- Spring loaded jaws
- Display packaged

260058

51 PC 3/8" DR MECHANIC'S SET



51-piece mechanic's socket set with a high torque quick release ratchet. Includes a variety of SAE and metric sockets.

- Features high torque quick release ratchet
- 108 gear teeth for 3.3 degree sweep and smaller head for tight areas
- 12pt SAE and Metric standard and deep wall sockets
- Chrome vanadium alloy steel for strength and durability
- Set contents: 3/8 in. dr. quick release ratchet, universal joint, 3 and 6 in. extensions, (2) spark plug sockets, (25) SAE and metric std. sockets and (20) SAE and metric deep sockets.
- Durable storage case also included
- SAE std. Sizes: 1/4, 5/16, 3/8, 7/16, 1/2, 9/16, 5/8, 11/16, 3/4, 13/16, 7/8 and 15/16 in.
- SAE Deep Sizes: 5/16, 3/8, 7/16, 1/2, 9/16, 5/8, 3/4, 13/16, 7/8 and 15/16 in.
- SAE Spark Plug sizes: 5/8 and 13/16 in.
- Metric std. Sizes: 7, 8, 9, 10, 11, 12, 13, 14, 15, 16, 17, 18 and 19mm
- Metric Deep Sizes: 8, 10, 12, 13, 14, 15, 16, 17, 18 and 19mm

260057

19 PC 3/8" DR BLACK SOCKET SET



19-piece socket set with both SAE and metric sockets. Laser-etched for easy reading. Durable chrome vanadium steel core.

- 18 double plated black sockets feature both SAE and Metric sockets in popular sizes.
- Easy to read laser etching.
- Ratchet features indestructible protective coating, chrome vanadium steel core with precision 72 gear teeth.
- 6pt SAE Sizes: 5/16, 3/8, 7/16, 1/2, 9/16, 5/8, 11/16, 3/4 and 13/16".
- 6pt MM sizes: 9, 10, 11, 12, 13, 14, 15, 17 and 19mm.

260054



MINI RAZOR SCRAPER

- Perfect at scraping labels & paint over spray off glass surface
- Tough polypropylene construction
- Protective safety cap
- Ergonomic grip for greater comfort & control
- Includes one standard razor blade

260060



7PC CHISEL & PUNCH SET

- Hardened and tempered high carbon steel construction
- Vinyl covered shank absorbs shock and reduces vibration
- Handy storage pouch
- Pin punch sizes: 3/16" x 6"
- Taper punch sizes: 1/8" and 3/16" x 6"
- Center punch sizes: 3/8"
- Cold chisel sizes: 3/8", 1/2" and 5/8"

260061



22 PC. SAE/METRIC BALL END HEX KEY SET

- Ball end wrenches are perfect for quick and convenient access to screw heads at angles up to 25 degrees
- Alloy steel construction
- Includes plastic holder for storage
- SAE sizes: 0.05, 1/16, 5/64, 3/32, 7/64, 1/8, 9/64, 5/32, 3/16, 7/32, 1/4, 5/16 and 3/8 in.
- Metric sizes: 1.5, 2, 2.5, 3, 4, 5, 6, 8 and 10 mm
- Display packaged

260062



30 PC. HEX KEY WRENCH SET

- Long and short shank hex keys.
- Alloy steel construction.
- Includes handy organizer.
- 15 Metric hex keys, sizes: .7, .9, 1.3, 1.5, 2, 2.5, 3, 4, 4.5, 5, 5.5, 6, 7, 8 and 10 mm.
- 15 SAE hex keys, sizes: .028, .035, .050, 1/16, 5/64, 3/32, 7/64, 1/8, 9/64, 5/32, 3/16, 7/32, 1/4, 5/16, and 3/8"

260063



MINI RAZOR SCRAPER

- Lightweight anodized aluminum body and chrome vanadium steel construction for strength and durability
- Ball end on hex keys allow use at angles up to 25° for obstructed areas
- Star keys work on regular and tamper proof star fasteners
- Keys conveniently fold for compact easy storage
- Coded in high visibility colors for easy identification

SAE hex key sizes:
1/16", 5/64", 3/32", 1/8", 9/64", 5/32", 3/16" and 1/4"

Metric hex key sizes:
1.5, 2, 2.5, 3, 4, 5, 6 and 8mm

Star key sizes:
T9, T10, T15, T20, T25, T27, T30 and T40

260064



PRO PISTOL GRIP GREASE GUN

- Professional quality heavy duty construction for long service life.
- Pistol grip action for easy use in confined, tight spaces.
- Vented zinc die cast head, bulk fill fitting and a comfort grip lever handle.
- Positive lock pull rod for easy filling, and a bleeder valve to eliminate air lock.
- Black Powder coating, knurled barrel provides corrosion protection and positive grip.
- Uses standard 14 oz cartridge or bulk.

260066



MINI GREASE GUN WITH GREASE

- Heavy duty construction. "Pistol Grip" action for easy use in tight spaces.
- Vented zinc die cast head cap.
- Positive lock for easy filling.
- Air bleeder valve eliminates air lock.
- Uses 3 ounce grease cartridge (included).
- Display packaged.

260067



MINI DIAL TIRE PRESSURE GAUGE

- 1 to 60 PSI range
- Measures 1 one pound increments
- 1" easy to read white face dial
- Proper tire maintenance saves money by improving fuel economy and reducing tire wear
- Ideal for cars, trucks, SUV's, bicycles and more

260069



DIGITAL TIRE PRESSURE GAUGE

- Backlit display and convenient lighted tip.
- Triple function display P.S.I., BAR, and KPa.
- Auto off feature: Automatically shuts off in 30 seconds when not in use
- Accurate to +/- 1 PSI
- Requires (5) AG13 button cell batteries (included)

260070



COMBO FINGERNAIL BRUSH W/MAGNET

- Contoured handle for grip
- Works as fingernail, hand or utility brush

260071



100 PC. BIT SET

- Use with screwdrivers, electric drills or socket wrenches.
- Includes bit adapters, magnetic bit holder, "Y" style bits, couplers, Phillips, pozi, square, slotted, spanner, star, torque, tamper resistant star, hex triwing, clutch head and spline bits.

260073



2 TON HYDRAULIC BOTTLE JACK

- Heat treated critical stress areas ensure long life performance
- Steel lifting saddle cleated for better load stability
- Two piece sectional handle for easy assembly and storage
- Oversize cast iron base for extra durability but still easily portable
- Extension top screw adjusts 1.97 in. to accommodate work height
- Weight: 5.6 lb.
- Lift Range: 7-1/8 to 13-1/2 in.
- Load Capacity: 4,000 lb.
- Meets or exceeds ASME PALD-2009

260074

2-1/2 TON GARAGE JACK



- A durable flanged steel frame powder coated and assembled with rust-resistant hardware
- Steel lifting saddle, cleated for better load stability
- Heavy-duty steel front wheels and ball-bearing swivel rear wheels provide easy positioning
- Convenient carry handle and only 28 lbs., a great choice for cars and light-duty trucks
- Lift Range: 5-3/8 to 15-1/4 in.
- Load Capacity: 5,000 lb.
- Meets or exceeds ASME PALD-2005

260075

3 IN 1 STAPLER



- Easy slide open staple loading feature
- Easy smooth squeeze
- Handy storage case
- Includes 300 staples, 300 nails and 300 U-Shaped staples
- Comfort grip handle for extended use

260076

6IN. QUICK RELEASE C-CLAMP



- 6-in. jaw width clamps with a tough enamel finish
- Chrome plated screw threads
- Precision crafted for smooth operation
- Features quick-release button to save time and twisting
- Malleable iron construction

260080

CABLE TIES UV/40 LB.



- Specifications: Measurements - 8 x 0.14 in. (200 x 3.6 mm), Tensile strength: 40 lb. (18 kg), Bundle diameter capacity: 2 in. (50 mm), Temp Range: -40 to 221F (105c)
- Certifications: UL listed - E243263 (Type-21 and 94V-2 flammability), RoHS - UNSPSC 39121703, CE certified - EN 62275:2015, and ISO9001/19001 process certified

SIZES	PART #
100 pc. 8" White	260082
100 pc. 8" Black	260083

50 PC. 11" CABLE TIES



- Self-locking cable ties grip securely and provide a quick, inexpensive way to secure wires, hoses, fencing and more
- Nylon 6/6 resins are UL/CE tested for purity, ISO 9001 manufacturing, and 100% QC inspections guaranteeing outstanding performance and consistency
- UV-stable carbon, added to the nylon resin, is CE lab certified and provides up to 10X the lifespan of non-treated ties when exposed to direct sunlight
- Measurements: 11 x 0.14 in. (279 x 3.6 mm), Tensile strength: 40 lb. (18 kg), Bundle diameter capacity: 3 in. (76 mm), Temperature range: -40 to 185 °F (85 °C)

260081

2 TON JACK STANDS (1 PAIR)



- Constructed of heavy duty steel for strength and durability
- Large saddle surface area provides better contact
- Ratchet style for easy adjustments
- Durable, weather-resistant powder-coated surface
- Lift Range: 10-3/8 to 16-3/8 in.
- Load Capacity: 4,000 lb. (2,000 lb. capacity per jack stand)

260086

4-1/2 IN. ANGLE GRINDER



- Powerful 4.4 Amp Motor with 12,000 RPM No-Load speed
- 5/8-11 spindle with 2 in. head button for mounting the most popular 4 in. to 4.5 in. wheels
- 2-Position side handle for right or left hand use
- Redesigned metal gear case dissipates heat for longer life
- Spindle lock for quick wheel/blade changes
- Bonus pack includes: 4-1/2 in. grinding wheel, 2-type 1 metal cut off wheels, 40, 80 and 120 grit flap discs, side handle
- Also comes with replaceable motor brushes to extend tool life and spindle wrench

260087

4-WAY FOLDING LUG WRENCH



- Heavy duty drop forged steel
- Chrome plated to resist corrosion
- Folds down for compact storage
- Metric sizes 17mm, 19mm, 21mm and 23mm
- SIZES: See included images for sizes and quantities included

260089

40IN. 6-CASTER PLASTIC CREEPER



- Contoured shape for comfort and easy movement.
- Casters swivel 360° for easy movement.
- Blow molded base built-in storage tray.
- Oil and water resistant wheels.
- Fully padded headrest.
- 300lbs capacity.
- Dimensions: 40in x 17in x 4-1/2 in (101.6cm x 43.1cm x 11.4cm)

260090

3 PC. STEP DRILL SET



- 1/4" hex shank 3 bit set replaces 17 individual drill bits.
- Titanium nitride coated high speed steel.
- For use with metal, wood and plastic.
- Starts on contact, no center punch needed.
- Automatically deburrs holes as you drill.
- Sizes: 6 step: 3/16, 1/4, 5/16, 3/8, 7/16, 1/2"; 9 step: 1/4, 5/16, 3/8, 7/16, 1/2, 9/16, 5/8, 11/16, 3/4"; 13 step: 1/8, 5/32, 3/16, 7/32, 1/4, 9/32, 5/16, 11/32, 3/8, 13/32, 7/16, 15/32, 1/2"

260091

29 PC. DRILL BIT SET W/STEEL CASE



- Durable titanium nitride coated high speed steel.
- Sizes: 1/16" through 1/2" in 64th increments.
- Handy steel storage box included.

260092

6 IN. PLASTIC CALIPER



- 4 way measurements for outside, inside, step and depth.

260093

HARDWARE ASSORTMENTS

200 PC SPRING ASSORTMENT



W5200

560 PC COTTER PIN ASSORTMENT



W5205

150 PC COTTER PIN ASSORTMENT



W5206

150 PC HAIR PIN ASSORTMENT

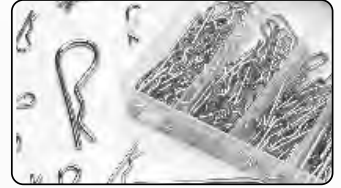

W5210

300 PC E-CLIP ASSORTMENT



W5208

300 PC SNAP RING ASSORTMENT

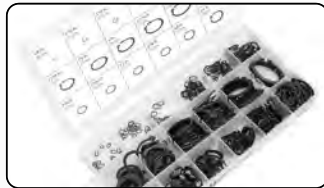

W5212

26 PC. HOSE CLAMP ASSORTMENT



W5348

347 PC. METRIC NUTS & BOLTS ASSORTMENT



W5221

720 PC. WASHER ASSORTMENT



W5218

200 PC. HEX HEAD SELF DRILLING SCREWS



W5220

1200 PC. NUT & BOLT ASSORTMENT



W5226

70 PC. GREASE FITTING ASSORTMENT



W5215

500 PC. RIVET ASSORTMENT SET



W5228

150 PC. WING NUT ASSORTMENT



W5219

347 PC. SAE NUTS & BOLTS ASSORTMENT



W5221

285-PIECE ELECTRICAL REPAIR KITS



W5207

160 PC. WIRE TERMINAL ASSORT.



W52131

120 PC. FUSE ASSORTMENT

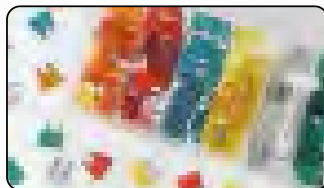

W5368

120 PC MINI FUSE ASSORTMENT



260088

5 PC. TAPERED EXTRACTOR SET

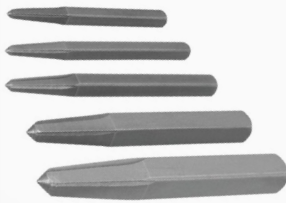

- Removes broken studs, screws, bolts, pipes and pipe fittings.
- Chrome vanadium steel.
- Features flutes for more positive grip.
- Includes handy organizer.
- Sizes: 1/8, 3/16, 15/64, 5/16 and 3/8"

260094

7 PC. BEARING RACE & SEAL DRIVER



- Quickly & easily inserts wheel bearing races and seals without damage to race or axle housing
- Set includes (6) aluminum discs to fit common sizes: 1.565, 1.75, 1.965, 2.325, 2.47 and 2.555 in.

260095

PISTON RING COMP 2-1/8 TO 5"



- Use to install pistons on most passenger cars and truck engines
- Positive compression and adjustable friction brake.
- Instructions included.
- Band Diameter Sizes: SAE 2 1/8 to 5" (Metric 53 to 127mm)

260096

COMPRESSION TESTER - 0-300 PSI



- Compression tester 0-300 psi.
- Tapered rubber tip fits all common spark plug holes.
- Large easy to read gauge.
- SAE (0 PSI to 300 PSI) and Metric (1 to 21 kg/cm2).

260097

6 IN. COMPOSITE DIGITAL CALIPER



- Rugged impact resistant composite material
- Easy to read SAE and metric LCD display
- Low battery warning with 12-month average battery life
- Includes 1.5V AG13 button cell battery
- Specifications: accuracy +/- 0.01 in. (0.2 mm)
- Resolution: 0.01 in. / 0.1 mm
- Throat depth: 1-9/16 in. (39.7 mm)
- Temperature operating range: 32 deg. F to 104 deg. F (0 deg. C to 40 deg. C)
- Overall length: 9-1/2 in. (240 mm)

260098

7 PC. GREASE GUN ACCESSORY KIT



- For all types of grease lubrication applications.
- 1 press on 90 degree angle tip.
- One straight extension tip.
- One 12" hose extension.
- One slide on 90 degree coupler.
- One rubber tipped nozzle.
- One needle nozzle.
- One 360 degree coupler.

260099

SUCTION GUN



- Professional quality heavy duty construction for long service life.
- Perfect for transmissions, differentials, gear cases, lower units, crankcases, etc.
- Zinc head, 12in. flexible hose, and 1 pint total capacity.
- No priming necessary, just submerge the hose end and draw the handle back.
- Black Powder coating, knurled barrel provides corrosion protection and positive grip.

260100

BEARING PACKER



- Quickly and thoroughly packs bearings with new grease while forcing out old grease all in one easy operation
- Accommodates most roller and ball bearings
- Cone diameter is 4-1/2 in.
- Made of high-impact plastic with an aluminum center shaft

260101

12 INCH 4500 PSI FLEXIBLE HOSE



- 12" hose for hard to reach areas.
- For use with hand and air powered grease guns.
- Size: 12"
- Working Pressure (PSI): 4,500
- Burst Pressure (PSI): 12,000
- NPT (IN): 1/8"
- Display packaged

260102

18 INCH 4500 PSI FLEXIBLE HOSE WITH COUPLER



- 18" hose for hard to reach areas
- For use with hand and air powered grease guns
- Size: 18"
- Working Pressure (PSI): 4,500
- Burst Pressure (PSI): 10,000
- NPT (IN): 1/8"
- Display packaged

260103

GREASE GUN COUPLER



- Fits most hand operated grease guns.
- Maximum Working Pressure (PSI): 3,000
- Burst Pressure (PSI): 6,000
- NPT (IN): 1/8"
- Warranty: Lifetime

260104

NEEDLE NOSE ADAPTER



- Dispenses a fine line of grease to confined areas
- Great for 4WD (CV) universal joints
- WARNING: Maximum working pressure - 3,000 PSI
- For use with hand grease guns only

260107



SMALL OIL FILTER PLIERS

- Comfort grip handles
- Safety button locks in place
- Three different positions
- Fits sizes 2" to 3-1/4" diameter

260109



SWIVEL FILTER WRENCH

- 2 15/16 to 3 3/4
- Swivel handle design provides access in confined areas
- Vinyl grip handle
- Studded band for better grip
- Removes most spin on type filters

260111



PLASTIC FUNNEL W/18" SPOUT

- 6 Diameter funnel
- 18 Flexible spout

260112



2 PC. FLEX FUNNEL WITH HANDLE

- Removable spout for multiple applications
- Easy hold handle

260113



DIGITAL TIRE INFLATOR

- Measure tire pressure from 0-150psi, 20-1000 kpa
- Change digital readout between psi, kpa, bar and kg/cm2 with a push of a button
- Back-lit blue LCD display
- Includes 2 AAA batteries, 1/4" male inlet, and valve core tool
- Built-in bleed button for lowering pressure
- Accurate within 0.5 psi

260114



2-IN-1 WIRE STRIPPER/CRIMPER

- Two tools in one - Stripper and Crimper
- One end features a professional grade stripper for AWG sizes 10, 12,14, 16, 18 and 20 gauge wire
- Flip the handles around and you have a full range crimper for 22-18, 16-10 and 310/311/410/411 size terminals
- Precision machined and hardened jaws
- Three position safety lock: open to switch, lock to hold on position, closed to prevent operation
- Comfortable non-slip grips

260115

QUART/GALLON FLUID PUMP



- Unique double threaded cap fits both quart and gallon size containers.
- Convenient and versatile for hard to reach places.
- Eliminates mess and waste.
- Pumps approx. 5cc per stroke
- US Patent 7,857,172

260116



DELUXE RUBBER SIPHON HOSE

- All-purpose for transferring a variety of liquids, including oil, water, gasoline, or diesel
- Perfect for the seasonal transfer, or draining of liquids from lawnmowers or other equipment
- Easy to use, insert the siphon hose into the liquid, pump the bulb, and gravity does the rest
- Used in a wide range of professions, from DIY automotive maintenance to professional mechanic shops
- The 6 ft. PVC hose and rubber bulb are resistant to oil and gas, ensuring long-lasting durability

260117

25' 16-GAUGE ORANGE EXTENSION CORD



- Vinyl covering protects against moisture, abrasion, and direct sunlight and is suitable indoor/outdoor use
- Three-prong plug, grounded for safety
- High visibility orange, with single outlet
- 13 Amp max rating

260121

3AAA LED PENLIGHT



- Super Bright Nichia LED never needs replacing.
- Anodized aluminum housing with pocket clip.
- Compact design fits anywhere. Requires 3AAA batteries (included).
- Specs: 72 Lumens, 4.5 hour run time, 1333cd beam intensity, 73m beam distance.

260123

HANDYMAN FIRST AID KIT



- This kit combines the first aid essentials needed in the event of a minor injury in your work area
- Compact zipper case with handy carabiner clip
- 5 Pieces Fabric bandages - 3 in. x 1 in. (7.5 cm x 2.5 cm)
- 4 Pieces Fabric knuckle bandages
- 4 Pieces Fabric Fingertip bandages
- 0.5 oz (15 ml) Saline solution
- 1 Piece Non-woven triangular bandage
- 2 Pieces Small dressing
- 1 Piece Finger dressing
- 6 Pieces Safety pins
- 2 Pieces Alcohol wipes

260118

FLASHLIGHT W/LASER 43LM 3-IN-1 UV



- Features high output flashlight, UV light and laser pointer
- Super Bright Nichia LEDs never need replacing
- Anodized tactical aluminum housing
- UV light great for fluid and glass leak detection, ID and document verification, currency detection and more
- Specs: 43 lumens, 7.5 hour run time, 41m beam distance, 440cd peak beam intensity
- US Patent D685939

260126



FIREPOINT 1000LM DUOFOCUS

- Produces over 1000 lumens.
- Comparable to a 100 Watt lightbulb.
- Adjustable Duo.
- Focus beam goes from spot to flood.
- Super Bright Cree LED never needs replacing.
- Anodized tactical aluminum housing.
- Water and impact resistant 1068 lumens on high, 209 lumens on low, 13hr runtime, 346m beam.
- 9AA Batteries included.

260132

100 AMP BATTERY LOAD TESTER



- Accurately test the condition of your battery and charging systems.
- Performs both a voltage test and 15-second battery-load test. 100-amp capacity.
- Reliable and highly accurate, works on both 6- and 12-volt batteries
- Extra heavy leads with strain relief and color-coded, insulated, copper plated steel clamps

260133



BATTERY ALTERNATOR TESTER

- Easy to use battery / alternator tester.
- Plug in to the 12V cigarette lighter in your car, the LED indicators will show you the status of your battery and alternator.
- 3 LED indicators to show the battery condition: weak, normal or strong.
- 3 LED indicators to check the status of the alternator voltage: low, normal or high.
- Works on any 12 volt system, compact design for easy storage.
- Compact size, a handy item for your glove box so you know right away if the problem you have is related to the battery or alternator.

260134

12PC RAIL HOOK SET



- This set contains 4 each of the J, L and double loop hooks
- Small hooks provide flexible storage solutions to help organize your work area
- Hooks mount easily onto our bin rail set 260136 or with any of the rails that come with the Dual Position Tilt Bin line
- Easily moved anywhere along your bin rail for maximum flexibility
- Kit

260135



32" BIN RAIL SET (2 PIECES)

- Add on rails can be use with both Dual Position Tilt Bins and standard Performance bins to expand your storage system
- Holes are predrilled at 16" intervals for mounting to wall studs or standard peg board holes
- Rails are 3.5" tall and 31.75" long

260136

CLEAR PLASTIC BIN DIVIDERS

- Use these clear plastic dividers with the Dual Position Tilt Bins and Clear Bins (above) to divide bins in half to make the most of your storage options



6 PIECE DIVIDERS SMALL

260140

Use with Item 260137

4 PIECE DIVIDERS MEDIUM

260141

Use with Item 260138

3 PIECE DIVIDERS LARGE

260142

Use with Item 260139

26 PC. KEY TYPE HOSE CLAMP ASSORTMENT



- Key type hose clamps, no tools needed
- Sizes include: 1/2", 5/8", 3/4", 7/8" and 1"
- Handy storage case keeps sizes organized
- Large easy to turn keys tighten securely

260143

100 PK. UTILITY KNIFE BLADES



- Easy to use blade dispenser
- Fits standard utility knives
- Heavy duty blades precision honed to razor edge
- Indispensable around the home, shop & office
- Includes 100 blades

260145

HIGH VISIBILITY LED BIT DRIVER



- Three bright white LEDs illuminate your work area
- Ergonomic non-slip molded handle
- On-board bit storage
- Includes #1, #2 Phillips bits, and 3/16" and 1/4" slotted bits
- US Patent Number D693201

260148

BOOT & SHOE BRUSH



- Wood blocks with heavy duty steel frame
- Screw down to any surface using the integrated tabs
- Heavy duty poly bristles that last

260149

9.5" CRIMPING PLIERS



- Ergonomic non-slip molded grips for improved comfort and control
- Premium quality drop forged and hardened chrome vanadium steel
- Induction hardened and precision sharpened cutting edges
- Slim nose shape for tight places
- Designed for crimping of both insulated and non-insulated solderless connections and terminals, as well as cutting 10-22 AWG wire
- US Patent Number D704523S1

260150

5 PC. 1/2" DR. THIN WALL IMPACT SOCKETS



- Protective sleeves and plastic inserts prevent scratching of wheels and lug nuts.
- Hollow design allows room for removing longer bolts.
- Color coded for easy identification.
- Heavy duty chrome molybdenum.
- Sizes Include: 17mm, 19mm (3/4), 21mm, 13/16 inch and 7/8 inch.

260151

10 PC IMPACT STAR BIT SOCKET SET



- Impact grade with oil resistant finish Includes socket storage rail
- 1/4" Dr: T10, T15, T20, T25, T27, & T30 3/8" Dr: T40, T45, T47, & T50

260152

9 PC IMPACT SAE HEX BIT SOCKET SET



- Sizes include 1/4" Dr: 1/4, 5/16 & 3/8in
- Sizes include 3/8" Dr: 7/16, 1/2, 9/16, 5/8, 11/16 & 3/4in
- Includes socket storage rail
- Space saving stubby design is 40% shorter than standard bit sockets allowing better access in confined areas
- Heavy duty impact-grade CrMi steel will not split or crack
- Oil resistant black manganese phosphate finish

260153

9 PC IMPACT METRIC HEX BIT SOCKET SET



- Impact-Grade With Oil-Resistant Finish
- Includes Socket Storage Rail
- INCLUDES: 1/4" DR: 6, 7, 8, & 10MM; 3/8" Driver and 12, 14, 17, 18, & 19MM
- SPACE-SAVING STUBBY DESIGN: 40% Shorter For Better Access In Confined Areas
- HEAVY-DUTY IMPACT-GRADE CRMO STEEL: Will not split or crack

260154

DELUXE COMPRESSION TESTER KIT



- Deluxe compression tester for gas engines
- 2-1/2" 300psi gauge with quick disconnect ends
- 5 threaded adapters to cover most gas engines
- Includes: 10mm, 12mm, 14mm, 16mm, and 18mm threaded adapters
- Includes the hard to find 16mm x 1.5 adapter
- Blow molded fitted storage case

260161

ALUMINUM POLISHING KIT



- This polishing kit is designed to be used for softer finishes like aluminum, brass, and copper
- Includes 4-oz black (first stage), brown (second stage) and white (final polish) polishing compounds
- Polishing pads include: 3" mushroom and 2-1/2" tapered cylinder
- Polishing felts include: 3-1/5" bullet, 2-1/5" conical, 2-3/10" cone and 2-3/10" pear
- Polishing wheels include: 2", 3" and 4" and share the same interchangeable shaft
- All have 1/4" round shaft for use with power drills

260155

STAINLESS POLISHING KIT



- This polishing kit is designed to be used for harder finishes like Chrome, Stainless steel and iron
- Includes 4-oz white (first stage), red (second stage) and blue (final polish) polishing compounds
- Polishing pads include: 3" mushroom and 2-1/2" tapered cylinder
- Polishing felts include: 3-1/5" bullet, 2-1/5" conical, 2-3/10" cone and 2-3/10" pear
- Polishing wheels include: 2", 3" and 4" and share the same interchangeable shaft
- All have 1/4" round shaft for use with power drills

260156

SHAKER SIPHON HOSE



- Shaker Siphon helps you transfer fluids with ease.
- Safely transfer fuels, gasoline, diesel, water and many other liquids.
- Great for home, farm, fleet, auto, marine and much more.
- Simply shake the hose up and down to start the transfer.

SIZES	PART #
1/2 in. - Shaker Siphon	260157
3/4 in. - Liquid Transfer	260158

BATTERY OPERATED TRANSFER PUMP



- Easier and more convenient than your standard siphon pump
- This highly versatile battery operated pump is capable of 2.6 gallons per minute
- Pump fuel from your safety can to a generator, car, motorcycle, lawn equipment or any other fuel driven item
- Works well with kerosene for heaters or stoves also
- Chemical fluids, cleaners, water (not for use with drinking water), light oil, etc

260160

ROLLING WORK SEAT



- Lightweight and durable composite seat with 4 swivel casters
- Storage trays and built-in storage compartment
- Great for working around wheels and brakes
- Size: 18" x 13.4" x 12.4"
- Weight capacity 330lb

260162

12" TOOL BAG



- 3 Pockets for easy organization.
- Tough 600 denier fabric construction.
- Reinforced bottom for added strength.
- Heavy duty stitching and bar tacking at stress points.
- Wide zipper opening for easy access.

260163



PLASTIC BOOT TRAY

- Perfect for muddy and wet boots and shoes
- Large enough to hold 3 pairs
- Made of 100% recycled materials

260164



8 PC. METRIC HEX KEY WRENCH SET

- Tough, chrome plated steel. Complete with handy "key ring" style holder to keep wrenches organized.
- Metric sizes: 2mm, 2.5mm, 3mm, 4mm, 5mm, 6mm, 8mm and 10mm.

W1113

5 GALLON AIR TANK



- 125 PSI maximum.
- Light weight, portable with handle for easy transport.
- Safety pressure bypass valve with manual override.
- On/off air adjustment dial.
- Industrial grade air hose with standard tire air chuck.
- High visibility yellow for added safety
- Parts Available Separately: Hose W10057, Manifold W10056, Gauge W10055

SIZES	PART #
5 Gallon Air Tank	W10005
11 Gallon Air Tank	W10011



11 PC. COMBINATION WRENCH SET

- Chrome Vanadium Steel Construction.
- Fully polished finish.
- Handy storage rack.
- SAE sizes: 1/4, 5/16, 3/8, 7/16, 1/2, 9/16, 5/8, 11/16, 3/4, 13/16 and 7/8".
- Metric sizes: 9, 10, 11, 12, 13, 14, 15, 16, 17, 18 and 19mm.

SIZES	PART #
SAE	W1061
METRIC	W1062

RETRIEVER CLAW & FLEXIBLE MAGNETIC RETRIEVER



- Pick up small items from confined areas with its flexible shaft
- Strong durable magnets and powerful claws for easy retrieval
- Carded

SIZES	PART #
24" Retriever Claw	W1184
24" Magnetic Retriever	W1182



2" CUP WIRE BRUSH - FINE

- 1/4" Shank.
- Heavy duty construction.
- Use with any power drill.
- Many utility cleaning uses at home and shop.

W1212



POCKET MAGNETIC PICKUP TOOL

- Telescoping handle extends magnet from 4 3/4" to 18 1/2".
- Compact size with pocket clip.
- Easily retrieves small parts from confined or hard to reach areas.

W1261



TELESCOPING SWIVEL INSPECTION MIRROR

- 2" round mirror with multi direction swivel for visual access to confined areas.
- Chrome plated corrosion resistant shaft extends from 10 to 17 in. (254 - 432 mm).
- Vinyl grip.

W1262



MAGNETIC PARTS TRAY

- High quality heavy duty magnet
- Sticks to almost any metal surface
- Keeps small metal parts and tools from getting lost or misplaced
- Very handy even sideways or upside-down

SIZES	PART #
5 1/2" Round	W1264
9 1/2" x 5 1/2" Rectangle	W1265



METAL BATTERY TERMINAL BRUSH

- All metal construction
- Quality stainless steel brushes
- Cleans both battery post and terminals

W147



PROFESSIONAL BATTERY TESTER

- Precision calibrated
- Color coded indicator float
- Acid resistant

W1653



6 PC. SCREWDRIVER SET

- Popular sizes for a variety of fastening needs.
- Oversized comfort grips for more turning power.
- Heat treated alloy steel blades for durability.
- Plated shafts for corrosion resistance.
- Contents: 3pcs Phillips screwdrivers and 3pcs Slotted screwdrivers.
- Phillips Screwdrivers: #3 x 6", #2 x 4", #1 x 3".
- Slotted Screwdrivers: 5/16" x 6", 1/4" x 4" and 13/16" x 3".

W1703



WIRE CRIMPER/STRIPPER

- Contains wire cutter, bolt cutter, crimper and stripper
- Includes assorted terminals

W190



AUTOMATIC WIRE STRIPPERS

- Cuts and removes insulation from wire with a single squeeze of the handle
- Accepts 18, 14, 12, 10 & 8 GA AWG wire

W200



61 PC. HAND RIVET GUN SET

- Includes riveter with 4 nozzles.
- 15 each of the following aluminum rivets: 3/32 in. 1/8 in., 5/32 in. and 3/16 in..

W2017



3 PC. INSPECTION TOOL SET

- Lighted Magnetic Pickup Tool Lifts up to 8lbs
- Bright LED light helps you find lost tools and parts
- Easily retrieves small objects from confined areas
- Extends from 6 1/2" to 33"
- Handy pocket clip
- Cushion grip handle
- Telescoping Inspection Mirror
- 2" round mirror
- Extends from 6 1/2" to 19"
- Requires (3) AG13 button cell batteries (included)
- US Patent D778473

W1932



CARBON AND GASKET SCRAPER

- Alloy steel construction.
- Plated to resist corrosion.

W234



2-N-1 LED LIGHT & LASER

- Flexible head super bright LED light
- Red laser pointer
- Pocket clip
- Magnetic base
- 3 bonus LR44 Batteries (6 batteries total)

W2380

2 in 1 Light & Laser
(Our Choice of Color)



24 LED WORKLIGHT

- Super bright LEDs never need replacing
- Strong magnet attaches to almost any metal surface
- Swivel hook adjusts to multiple angles and stores away easily
- 3AA batteries included
- Specs: 248 Lumens, 181cd Beam Intensity, 26.9m Beam Distance

W2424



POCKET LED FLASHLIGHT 55 LUMENS

- Super Bright Nichia LED never needs replacing
- Anodized aluminum flashlight
- 85 lumens, 9.5 hour run time, 100m beam

W2450



ALUMINUM LED FLASHLIGHT 55 LM

- Super Bright Nichia LED never needs replacing.
- Anodized aluminum housing.
- 55 lumens, 3.5 hour run time, 100m beam.

W2451



2 PIECE LED POCKET FLASHLIGHT 55 LUMENS

- 2 pack essential LED Flashlights
- Super Bright Nichia LEDs never need replacing
- Anodized aluminum housing
- 55 lumens, 3.5 hour run time, 100m beam

W2459



LED BATTERY TESTER

- For all 12 volt systems
- Easy to read L.E.D. lights
- Determines battery state of charge and level of alternator output

W2980



DIGITAL MULTI-METER TESTER

- Features AC & DC volt measurement, DC current measurement, resistance measurement, diode test & Ohms
- LCD, on/off switch and two 32" test leads
- Low battery and over range indicators
- Automatic zero adjust
- 9V battery included

W2974

CABLE TIE ASSORTMENT - 250 PC



- Self-locking cable ties grip securely and provide a quick, inexpensive way to secure wires, hoses, fencing and more
- Nylon 6/6 resins are UL/CE tested for purity, ISO 9001 manufacturing, and 100% QC inspections guaranteeing outstanding performance and consistency
- UV-stable carbon, added to the nylon resin, is CE lab certified and provides up to 10X the lifespan of non-treated ties when exposed to direct sunlight
- 25 pc. each: 4 in. (101 mm) in yellow and blue; 6 in. (152 mm) in white and black, with 18 lb. (8 kg) tensile strength
- 25 pc. each: 6 in. (152 mm) in red and green, with 40 lb. (18 kg) tensile strength
- 50 pc. each: 8 in. (203 mm) in white and black, with 40 lb. (18 kg) tensile strength
- Includes convenient, reusable, storage tube

W2918

CABLE TIE ASSORTMENT - 1000 PC



- Handy assortment of lengths and colors for the home, office, or shop
- Self-locking cable ties grip securely and provide a quick, inexpensive way to secure wires, hoses, fencing, and more
- Nylon 6/6 resins are UL/CE tested for purity, ISO 9001 manufacturing, and 100% QC inspections guaranteeing outstanding performance and consistency
- UV-stable carbon, added to the nylon resin, is CE lab certified and provides up to 10X the lifespan of non-treated ties when exposed to direct sunlight
- 100 pc. each: 4 in. (101 mm) in red, blue, green, yellow, and white, w/18 lb. (8 kg) tensile strength
- 100 pc. 6 in. (152 mm) in white, w/18 lb. (8 kg) tensile strength
- 100 pc. each: 8 in. (203 mm) in white, red, and yellow, w/40 lb. (18 kg) tensile strength
- 100 pc. 12 in. (304 mm) in white, w/40 lb. (18 kg) tensile strength
- Includes convenient, reusable, storage tube

W2925

DELUXE 12V TESTER



- Checks 12 volt accessory circuits
- For autos, trucks, trailers and boats
- Test lead with alligator clip

W2975C

POCKET MULTI-TESTER



- Tests AC and DC circuits
- Volt and ohm analyzer
- Includes batteries and instructions

W2979

3/8" IMPACT DRIVER WITH 4 BITS



- Ideal for loosening firmly tightened or rusted screws or bolts.
- Removable hex adapter allows use with 3/8" drive sockets & accessories.
- Heavy duty blow molded storage case.
- Phillips sizes: #2 & #3
- Flat sizes: 5/16" & 3/8"
- Replacement bits - see part number W2500-36MM

W2500



**HEAVY-DUTY CIRCUIT TESTER
- 12V**

- Heavy duty test lead with spring clip
- Tests 6, 12 and 24 volt AC and DC circuits
- Reinforcing spring prevents damage to test lead at base of handle

W2981



3 PC. ADJUSTABLE WRENCH SET

- Soft cushion grips with ergonomic shape for safe easy use.
- Precision SAE and Metric rule on wrench heads for accuracy.
- SAE box ends in handles: 3/8, 9/16 and 3/4".
- Machine polished finish and drop forged for long life.
- 6 inch (150mm), 8 inch (200mm) and 12 inch (300mm)

W30703

7 PC. PLIER SET



- Includes 10" groove joint pliers, 7 1/2" diagonal cutter, 8" long nose plier, 8" slip joint pliers, 4 1/2" diagonal cutter, bent nose and end nipper pliers.
- Indispensable pliers set for the home or shop
- Comfort grips with ergonomic shape for safe easy use
- Drop forged alloy steel construction
- Machined jaws for maximum gripping strength
- Cutting pliers feature induction hardened cutting edges for durability

W30759

MULTI-PURPOSE LIFT JACK



- 1,500 lb. capacity.
- 4 1/2" to 16 1/2" lift range.
- Two safety bolts ensure stability.
- Three position locking levers.
- Non-slip rubber foot pedal.
- Easy to roll steel swivel casters.

W41035

**7-IN-1 STUBBY SCREWDRIVER
SET**



- High torque ratchet with 3 settings: forward, locked & reverse
- Ergonomic transparent handle stores 6 bits
- 1" (25mm) Bit Sizes: Phillips, #1, #2, #3, Slotted 5/32 inch (4mm), 1/4 inch (6mm), Star, T15, T20
- 4 colors: blue, green, red and yellow

W38927



2 TON CABLE POWER PULLER



- 2 ton pull capacity (rolling)
- Cable length 12 feet x 5mm diameter with hooks
- Single laminated gear/pawl
- Handle and frame thickness 3.5mm
- Yellow zinc plated

W4000

SAE, METRIC TAP AND DIE SET



- NC, NF and NPT sizes.
- Blow molded plastic storage case.
- Set Includes: 17 taps and 17 dies, tap wrench, T-handle tap wrench, die stock, screwdriver and screw pitch gauge.
- SAE - Die included: 4-40 NC No.43, 6-32NC No.36, 8-32 NC 9/64-inch, 10-24 NC 5/32-inch, 10-31 NF 11/64-inch, 12-24 NC 1/3-inch, 1/4-20 NC 13/64-inch, 1/4-28 NF 7/32-inch, 5/6-18 NC 17/64-inch,
- SAE - Die included (continued): 5/16-24 NF 9/32-inch, 3/8-16 NC 5/16-inch, 3/8-24 NF 21/64-inch, 7/6-14 NC 3/8-inch, 7/16-20 NF 25/64-inch, 1/2-13 NC 27/64-inch, 1/2-20 NF 29/64-inch, 1/8-27 NPT 21/64-inch.
- METRIC - Die sizes: 1/8-inch NPT, M3 x 0.5, M3 X 0.6, M4 x 0.7, M5 x 0.8, M5 x 0.9, M6 x 0.75, M6 x 1.0, M7 x 0.75, M7 x 1.0, M8 x 1.0, M8 x 1.25, M10 x 1.25, M10 x 1.5, M12 x 1.5, M12 x 1.75.

SIZES	PART #
SAE	W4001
Metric	W4002

ALL PURPOSE FUNNELS

- Great for dispensing petroleum based fluids and much more.
- Extra wide mouth prevents spills.
- Comes with hanging hook for convenient storage.
- Easy to use.



1 QUART
W4064



1 PINT
W4015



1/2 PINT
W4007



18"
W40340

PVC ELECTRICAL TAPE



- Black
- UL listed
- Multiple uses around shop, home & auto
- PVC tape
- Withstands temperatures from -7° to 80° C
- Suitable for use at no more than 600V and no more than 176°F (80°C)

SIZES	PART #
7 mil x 3/4 in. x 30 ft.	W501
7 mil x 3/4 in. x 60 feet	W502

DUCT TAPE



- 1-7/8" x 30'
- Sold each

W3103



PRO LEVER ACTION GREASE GUN



- Professional quality heavy duty construction for long service life.
- Short stroke lever action for easy use in tight spaces.
- Vented zinc die cast head , bulk fill fitting and a comfort grip lever handle
- Positive lock pull rod for easy filling, and a bleeder valve to eliminate air lock.
- Black Powder coating, knurled barrel provides corrosion protection and positive grip.
- Uses standard 14 oz. grease cartridge.

W54202

PLASTIC FUNNEL



- 2-quart plastic funnel
- Rugged, corrosion resistant all purpose funnel
- Complete with fine mesh straining screen and handy hanging tab
- Capacity indicates what the funnel will hold when the outlet is blocked

W54276

UTILITY KNIFE & BLADES



- 3 position retractable blade.
- Extra blade included stores in handle.
- Indispensable around the home, shop & office

DESCRIPTIONS	PART #
Knife	W745
Blades (5 pk)	W744

7 PC PROFESSIONAL SCREWDRIVER SET



- Phillips sizes: #1 x 3" and #2 x 4".
- Slotted sizes: 3/16 x 4", 1/4 x 4", 1/8 x 4" and 3/8 x 8".
- #1 x 3", #2 x 4" Phillips
- Heat treated alloy steel blades for durability
- Plated shafts for corrosion resistance

W80007

8 PC PROFESSIONAL SCREWDRIVER SET



- Oversized handles for easy use.
- Magnetic tips.
- Phillips sizes: #1 x 3", #2 x 1 1/2", #2 x 4".
- Slotted sizes: 3/16" x 3", 1/4" x 1 1/2", 1/4" x 4".
- Star: T-15 and T-20 x 4".

W80008

STAINLESS STEEL DIGITAL CALIPER - 6 IN.



- Measures outside, inside, step and depth
- 0 in. to 6 in. (0 mm to 150 mm) range
- SAE to metric conversion with the push of a button
- Large easy to read LCD display
- Zero setting at any position within measuring range
- Thumb wheel with lock
- LR44 button cell battery included

W80152

T-HANDLE HEX, STAR KEY SET - 10 PC.



- Heat treated alloy steel shafts.
- Plastic grips add comfort and turning power.
- Bonus storage tray mounts on wall or bench.
- SAE sizes: 3/32, 7/64, 1/8, 9/64, 5/32, 3/16, 7/32, 1/4, 5/16 and 3/8".
- Metric sizes: 2, 2.5, 3, 4, 4.5, 5, 5.5, 6, 8 and 10mm.
- Star sizes: T7, T8, T9, T10, T15, T20, T25, T27, T30 and T40.

SIZES	PART #
SAE	W80274
METRIC	W80275
STAR	W80276

SPARK PLUG WIRE TESTER



- Identifies damaged spark plug wires easily.
- Tester flashes in sync with spark plug firing until it runs across a break in wire.

W80530

SMALL ENGINE CYLINDER HONE



- Piston cylinder hone 2" - 7"
- Flexible shaft
- Adjustable honing tension
- 2" to 7" diameter range (50.8-177.8mm)
- 2" through 4" and 4" through 7" settings
- Three 220 grit 3" stones

DESCRIPTIONS	PART #
Cylinder Hone	W80560
Set of 3 Repl. Stones	W80561

PISTON RING INSTALLER



- Expanding Pliers allow for safe and quick installation of piston rings 3/64 in. to 1/4 in. on most passenger cars and light trucks
- Vinyl-coated handles with a nonslip rubber grip offer safe and comfortable operation
- Constructed from all steel with tapered jaws for a quick and easy installation process

W80575

2 PC. SPECIALTY PICK SET



- Hardened tips.
- Knurled center grips.
- Also useful for retrieving small parts, nuts, washers, etc.
- Contains 90 degree double end scribe for etching metals and soft materials.
- O-ring and seal pick for easily removing and installing o-rings and seals.

W80750

BAR STOOL W/SWIVEL SEAT



- 30" tall
- Durable, easy to clean, 14" round vinyl padded swiveling seat
- Black powder coated tubular steel legs

W85010





7-WAY CRIMPING TOOL

- Wire cutter, terminal crimper & wire stripper in one handy tool
- Black anodized finish with insulated grips
- Crimp slot on end of tool secures most ignition terminals including “_” type, right angle and “High Tower” terminals
- Crimps 7mm to 8.5mm ignition wire
- Works with 10-22 gauge solderless terminals

W86500



HEAVY DUTY NUT SPLITTER

- Removes rusted, stripped and stubborn nuts.
- Self centering wobble tip.
- Offset design for easier operation.
- Splits nuts 7/16” to 3/4”.
- Drop forged steel construction.
- Plated to resist corrosion.
- Heat treated chisel.

W88030



3/8” DR. 6PT DEEP SOCKET

- Recessed edges.
- Socket openings are designed to reduce fastener rounding.
- Chrome vanadium alloy steel construction for strength and durability.
- Polished nickel chrome plated finish resists corrosion.
- Large stamping for quick identification.

SIZES	PART #
14mm	W886
18mm	W890



TELESCOPING MAGNETIC PICKUP TOOL 8 LB.

- Heavy duty magnetic tip retrieves up to 8 lbs.
- Retriever extends over 24”
- Cushion grip handle
- Handy pocket clip

W9101



POCKET SCREWDRIVER COMBO

- Phillips and slotted screwdriver bits
- Phillips: #1 and #2
- Slotted: 3/16 and 1/4”
- Built in level
- Mini LED light
- Convenient pocket clip
- Includes 3 LR44 batteries



Red, Blue or Yellow
(Our Choice of Color)

W9161



8 PC. SPECIALTY PICK/DRIVER SET

- Chrome vanadium steel shafts with magnetic tips.
- High visibility PVC handles.
- Contains curved hook, 90 degree hook, offset 45 degree hook, 1/8” slotted screwdriver, #0 Phillips screwdriver, straight pick, T15 star driver, T20 star driver.

W941



UTILITY KNIFE BREAK AWAY

- Retractable blade with automatic lock
- End cap detaches to safely break blade tips
- Yellow in color

W972



120 PC. HEAT SHRINK TUBING SET

- Sizes include: 5/32", 3/16", 9/32" and 5/16" diameters
- Set includes: Five different colors with 15 pieces of each size
- Set color-codes; positive, negative and ground for easy identification
- 100% polyolefin construction, UL listed
- Handy divided container keeps pieces organized

260144



SPARK PLUG GAUGE & GAP TOOL

- Accurately set spark plugs with electrode tool included.
- 7 durable round wire blades in decimal and metric sizes.
- SAE Sizes: .020, .025, .028, .030, .032, .035 and .040"
- Metric Sizes: .50, .63, .71, .76, .81, .89, 1.00 mm

W162



LARGE OIL FILTER PLIERS

- Comfort grip handles
- Safety button locks in place
- Three different positions
- Fits sizes 1-7/8" to 4" diameter

260110



THICKNESS GAUGE - 32 BLADES

- Decimal and metric sizes.
- 32 blades 3-1/2 in. long
- .010" brass blade for transistorized ignitions.
- SAE Sizes: .0015, .002, .0025, .003, .004, .005, .006, .007, .008, .009, .010, .011, .012, .013, .014, .015, .016, .017, .018, .019, .020, .021, .022, .023, .024, .025, .026, .028, .030, .032, .035"
- Metric Sizes: .04, .05, .06, .08, .10, .13, .15, .18, .20, .23, .25, .28, .30, .33, .35, .38, .40, .43, .45, .48, .50, .53, .55, .58, .60, .63, .65, .70, .75, .80, .88 mm

W125



THICKNESS GAUGE - 15 BLADES

- Decimal and metric sizes.
- 3" steel rule.
- SAE Sizes: .002, .003, .004, .005, .006, .008, .011, .012, .013, .014, .016, .018, .020, .022 and .025"
- Metric Sizes: .05, .08, .10, .13, .15, .20, .28, .30, .33, .35, .40, .45, .50, .55 and .63 mm

W131



SPARK PLUG GAP GAUGE

- Easy to read markings to set gaps quickly and easily.
- Tapered hole adjusts electrode.
- Carded Sizes: SAE .020 to .100"; Metric 0.5 to 2.5mm.

W80535



SPARK PLUG HOLE CHASER - 14MM/18MM

- Quickly and easily cleans dirt, carbon and metal particles from spark plug hole.
- Not to be used as a tap.
- Sizes: 14mm & 18mm

W80539

7 QT. PLASTIC DRAIN PAN



- Molded handles and pour spout.
- Easy to use.
- Chemical and solvent resistant, won't rust or corrode.
- Dimensions: 13 1/2" x 11" x 4".

260065



PERFORMANCE TECH GLOVE

- Extra large and Large size
- Fits a wide range of hands
- Guards hands from cuts, scrapes & burns
- Designed and tested by mechanics for comfort and durability
- Thick enough to protect, thin enough to handle small objects
- Soft, breathable fabric that's easy to clean

SIZES	PART #
Medium	W88999
Large	W89000
X-Large	W89001

GREASE INJECTOR NEEDLE



- 18 ga. Tempered stainless steel
- Can be easily inserted under or through bearing seals
- Includes protective cover
- WARNING: Maximum working pressure - 3,000 PSI. For use with hand grease guns only

260105



4" GREASE GUN NEEDLE NOSE ADAPTER

- Dispenses a fine line of grease to confined areas
- Includes large and small sleeve to fit standard couplers
- Great for 4WD (CV) universal joints
- WARNING: Maximum working pressure - 3,000 PSI. For use with hand grease guns only

260106

WALL MOUNTED GREASE GUN HOLDER



- Wall mount design
- Center latch locks
- Corrosion resistant finish
- Display packaged

260108

SNAP RING PLIER SET



- Internal and external pliers
- Includes straight, 90 degree and 45 degree, 1.3 mm tips

1725

SOLDERING GUN KIT



- Built in spotlight
- Instant heat
- Includes: Soldering gun, extra soldering wire, soldering paste and extra tip
- Electrical Rating: 120V~ / 60Hz / 60 W. Maximum temperature: 1135°F
- Extra tip, Display packaged.

260119

HEAVY-DUTY 3-JAW GEAR PULLER



- Precision crafted for smooth operation
- Heat treated alloy steel
- Drop forged for strength
- Zinc plated finish

SIZES	PART #
4"	9020
6"	9021

UTILITY WIRE BRUSH



- 14 in. solid wood handle
- Steel bristles
- Cleans rust, paint, dirt, and more, quickly and easily

W1152

1/2 DRIVE SLICK TORQUE WRENCH



- Professional style.
- Chrome plated alloy steel.
- Compact size for tight spots.
- Ratchet style with engraved scale.
- Nickel chrome plated alloy steel.
- Size: 1/2" Dr., 10 to 150 ft. lbs.

W20001



1/2" DRIVE TORQUE WRENCH

- Precision-built, accurate
- 19" long with 1/2" square drive
- Direct reading scale: 0-150 ft.-lb. and metric kilograms 0-20 kg
- Most popular torque wrench size

W3001



DRIVE HEX BIT SOCKET 5/32" X 3/8"

- Recessed edges.
- Chrome vanadium alloy steel construction for strength and durability.
- Polished nickel chrome plated finish resists corrosion.
- Large stamping for quick identification.

W38876



50 PK. BX5 UTILITY KNIFE BLADES

- High quality SK2 steel lasts up to 5X longer than standard steel blades
- Easy to use blade dispenser. Fits standard utility knives
- Heavy duty blades precision honed to razor edge
- Indispensable around the home, shop & office

260146



ROLL AROUND STOOL

- Pneumatic action adjusts seat to 20" height quickly and easily.
- Convenient 15" diameter tool tray.
- Shielded 2 1/2" casters.
- Fully padded 12" diameter seat.
- 2 1/2" replacement caster assembly Performance Tool part # W85003.

W85008



12 PC. STAR BIT SOCKET SET

- Packaged on plastic slide rail for storage.
- Chrome vanadium alloy steel construction for strength and durability.
- Polished nickel chrome plated finish resists corrosion.
- 1/4" Drive sizes: T10, T15, T20, T25, T27 and T30.
- 3/8" Drive sizes: T40, T45, T47, T50 and T55.
- 1/2" Drive sizes: T60.

260056



10 PC. 1/4IN. DR. 6PT METRIC SOCKET SET

- Recessed edges.
- Socket openings are designed to reduce fastener rounding.
- Chrome vanadium alloy steel construction for strength and durability.
- Polished nickel chrome plated finish resists corrosion.
- Large stamping for quick identification.
- Packaged on plastic slide rail for storage.
- Deep Sizes: 4, 5, 6, 7, 8, 9, 10, 11, 12 and 13mm.

260039

3/8" DR. UNIVERSAL JOINT



- Chrome vanadium alloy steel construction for strength and durability.
- Polished nickel chrome plated finish resists corrosion.

260045

120V PORTABLE LED WORK LIGHT



- Ultra high output of more than 1000 lumens LED technology means unit stays cool enough to touch.
- Wide angle LEDs distribute large flood beam of light. 16in.
- 18GA power cable.
- Foam covered S-handle.
- On/off switch.
- Specs: 1030 lumens, Beam distance 65m, Max cd 1050.

260124

10 PC. 1/4" DR. 6PT SAE SOCKET SET



- Recessed edges.
- Socket openings are designed to reduce fastener rounding.
- Chrome vanadium alloy steel construction for strength and durability.
- Polished nickel chrome plated finish resists corrosion.
- Large stamping for quick identification.
- Packaged on plastic slide rail for storage.
- Sizes: 5/32", 3/16", 7/32", 1/4", 9/32", 5/16", 11/32", 3/8", 7/16" and 1/2"

260033

10 PC. 3/8" DR. SAE SOCKET SET



- Packaged on plastic slide rail for storage.
- Recessed edges.
- Socket openings are designed to reduce fastener rounding.
- Chrome vanadium alloy steel construction for strength and durability.
- Polished nickel chrome plated finish resists corrosion.
- Sizes: 1/4, 5/16, 3/8, 7/16, 1/2, 9/16, 5/8, 11/16, 3/4 and 13/16".

260043





MUFFLER PLUGS - BLACK



- Keep water, dirt and debris out of your exhaust while washing your bike or while it is traveling or in storage.
- Sold each.

SIZES	PART #
(2 STROKES) BLACK	992735
(4 STROKES) BLACK	992736
(4 STROKES - 6UNITS / 2 STROKES - 4 UNITS) BLACK	992737

PROOCTANE OIL MIXER 250ML



Prepare your oil/fuel mix with the help of Polisport Oil Mixer Bottle. It comes with a scale to help you prepare the mix. The mixer is available in two different capacities: 250 ml / 8.5 oz and 125 ml / 4.22 oz. Resistant and durable plastic material. Perfect to make the oil mixture. Capacity engraved. Available in different capacities

994608

OIL BEAKER - CLEAR



Plastic oil beakers to make the maintenance of your motorbike. They come in different sizes with the same durable and resistant plastic compound.

SIZES	PART #
1000CC	998987
500CC	998988
250CC	998989
100CC/0,026 GAL	998990





NGK STLYE SPARK PLUG CAP



- NGK resistor covers are manufactured using extremely durable phenolic resin and EPDM rubber
- Ceramic resistors are used to ensure optimum performance and reliability
- Resistor covers will with stand extreme heat, vibration, prevent flashover and are water proof
- 90 degree elbow 5K ohm resistance for terminal stud

MFG #	PART #
LB05EP	999692
LD05FP	999693
LD05F	999694
LB05FP	999696
LB05EZ	999698
XD05F	999700
LB05E	999701



Ratio Rite



RATIO-RITE PERFECT GAS/OIL MIXTURE MEASURING CUP

- Get a perfect mix every time
- Fill your polypropylene Ratio-Rite to the pre-calibrated ratio mark and pour into gas
- Ratios are from 16:1 to 44:1 for 1, 1-1/2, 2, 2-1/2 gal.
- Calibrations also include oz., cc's, and pints on the opposite side for transmission oil, for oil, etc.
- Total capacity is 24 oz.

RR100



REPLACEMENT LID FOR RR100

- Sold separately
- Seals the cup from dirt and spillage
- Lid can be attached to cup handle to keep from being misplaced

RR105

Ratio Rite

RISK



A Fast Flowing Utility Jug with Premium Features & Accessories

SIZES	PART #
EZ5 - 5 Gallon Utility Jug	989330
EZ3 - 3 Gallon Utility Jug	989331

EZ UTILITY JUG

The EZ Utility Jug is exactly what the name implies. It is a 3 gallon (12 liter) or 5 gallon (20 Liter) Utility Jug that is simply easy to use. It has a triple handle design that is completely unique. The top handle and side handle are obvious, but it is the third fingertip handle at the front of the jug that comes in handy during the end of the pour. This triple handle design allows the user to carry and pour at any angle with comfort and control.

Features

- 3 gallon (12 liter) or 5 gallon (20 liter)
- Durable thick-walled HDPE plastic
- 3 ergonomic handle design
- Unique breather allows adjustable venting, prevents leaks/spills & won't fall out or get lost
- Flat surface in center of jug for custom graphics
- Transport safely and securely with the EZ Floor Mount
- Recommended with our "Hose Bender" spout



EZ5 COMBO GALLON JUG BLACK HOSE & FLOOR MOUNT

- 5 gallon (20 liter)
- Durable thick-walled HDPE plastic ergonomic handle design.
- Unique breather allows adjustable venting, prevents leaks/spills and won't fall out or get lost.
- Flat surface in center of jug for custom graphics.
- Transport safely and securely with the EZ Floor Mount.
- Recommended with our "Hose Bender" spout (not included)



SIZES	PART #
EZ5 Combo 3/Gallon Jug	989344
EZ5 Combo 5/Gallon Jug	989345



BLACK HOSE BENDER - UTILITY JUG SPOUT

- Wrestling a full utility jug and getting the spout in and out of small container holes is always a challenge, which usually ends up with spilled liquids. Risk Racing now offers the "Hose Bender" spout, a utility jug spout which uses the cap and lanyard to create a natural bend to the hose.



989346

SEAL DOCTOR



Most dirt bike riders are faced with leaky fork seals several times a year. Riders are then challenged to repair a complicated and sensitive suspension system which requires specialty tools. The alternative is to pay for an expensive repair bill and take time off the bike while it is in the shop. Additionally, it can ruin a race day or an epic trail ride. However, having the ability to quickly and easily repair a leaky fork seal at the track or on the trail can save repair costs, race entry fees, salvage valuable title points or reclaim that weekend trail ride!

SIZES	PART #
LARGE (45MM-55MM)	989326
SMALL (35MM-45MM)	989327

MUD AXE

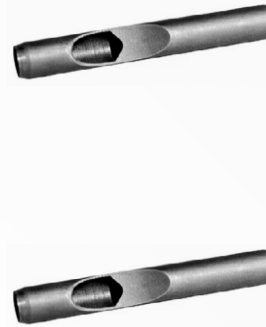

Any person that rides dirt bikes ends up in an intimate relationship with mud. Whether you are riding on the track or on the trails, you are eventually going to pack every nook and cranny of your bike with wet, sticky mud. Because of this, it is vital to understand how mud affects the performance of the bike. An engine packed with mud will tend to overheat quicker, and the added weight from the excess mud will negatively impact your bikes power, suspension tuning and overall handling. Additionally, it covers up your numbers and blocks important sponsor stickers.

989329

FLEXIT HEADLAMP PRO 6.5 650 LUMENS RECHARGEABLE



- Multiple LEDs for spotlight and 240° floodlight illumination
- 650 max lumen output for bright outdoor lighting
- Red night-vision and 360° flashing used for safety warning
- Rechargeable & removeable li-ion battery with 3350mAh capacity offers 12 hours of runtime
- Adjustable spotlight allows you to aim your beam without tilting your head

989354

FLI PRO TELESCOPING LIGHT

- Up to 1200 True Lumens
- Center CREE LED spotlight
- Flood LEDs for area lighting
- Red flood LEDs to preserve night vision
- Wireless Remote Control up to 15' (4.5m)
- Fully adjustable tripod
- USB-C rechargeable
- 4000mAh 21700 Li-ion battery included
- Weather resistant
- Lightweight at only 1lb 14oz (0.86kg) battery included



989355

TRIMOBILE WORK LIGHT WITH TRIPOD MOUNT



- Up to 2000 True Lumens
- Triple Pivoting Light Heads
- Flood area lighting
- Adjustable Brightness
- Dual Color Temperature Light Panel
- Magnetic Base
- Hanging Hook
- Optional Fully adjustable tripod stand
- Rechargeable with battery level indicator
- Weather resistant

989359

STKR FLI OVER-LANDER 10'
TELESCOPING LIGHT WITH
WIRELESS REMOTE



- 360° COB flood LEDs
- Up to 2600 True Lumens
- Fully adjustable brightness setting 0-100%
- Red flood LEDs to preserve night vision
- Wireless Remote Control up to 50' (15.2m)
- 14,000mAh Li-ion battery pack included
- Ability to charge other devices via USB
- USB-C rechargeable
- Weather resistant

989357

STKR FLI-TELESCOPING
AREA LIGHT - 6.5'



- 360° area light that fires a ring of high intensity LEDs down to the ground from a height of up to 6.5 feet, creating a 30ft diameter of light
- Telescoping pole with sturdy base
- Light weight and easy to carry, less than 2lbs
- 700 lumens with 4 modes including red flashing hazard
- Powered by rechargeable 18650 battery

989356



STKR FLEXIT HEADLAMP - 3.0 - LED - 300 LUMENS - MULTI
FUNCTIONAL

- 300 total true lumens; spotlight: 200 lumens, floodlights: 200 lumens
- Positional center CREE LED spotlight
- Side C.O.B. LEDs flood/area lighting - white
- Flexible body with shape-loc spotlight
- Durable ABS battery case
- 3 AAA batteries included
- IPX4 weather resistant
- 6 lighting modes
- Comfort fit foam
- Operation:
- Press Power/Mode to turn on
- Press to cycle through modes:
- 1 - High spot/high flood
- 2 - High spot
- 3 - High flood
- 4 - Low spot
- 5 - Low flood
- 6 - High spot + flashing hazard flood
- 7 - Off
- Runtime:
- Spotlight: high 6 hours, low 13 hours
- Floodlight: high 6 hours, low 13 hours
- Spotlight & floodlight: high 3.5 hours
- High flashing: 5 hours
- Dimensions: Size: 8.9" x 2.7" x 1.1" (22.6 cm x 69 mm x 28 mm)
- Lightweight at only 5.4 oz (153 g) battery included, 4.2 oz (116 g) battery excluded

989368



TELESCOPING 360° AREA LIGHT AND REMOVEABLE SHOPLIGHT

- Up to 2000 True Lumens
- Triple Pivoting Light Heads
- Flood area lighting
- Adjustable Brightness
- Dual Color Temperature Light Panel
- Magnetic Base
- Hanging Hook
- Rechargeable with battery level indicator
- Weather resistant

989358



FLEXIT UNDER HOOD LIGHT - MECHANICS FLEXIBLE WORK LIGHT

- Powerful 1,000 lumens output
- Compact and flexible design
- Dual adjustable straps for secure mounting
- 160° rotatable LED membrane
- 4 neodymium magnets for hands-free operation
- Four power modes including flashing red hazard mode
- Fast charging USB-C port
- High capacity 4400mAh rechargeable battery
- Durable and Weatherproof

989367



MAGNETIC LIGHT MINE - HANDS FREE FLASHLIGHT

- Bright LED
- 12 Neodymium magnets to aim light at many angles
- Use as a pick up tool
- Back slider on/off switch
- Weather resistant

989349



MAGNETIC LIGHT MINE PROFESSIONAL FLASHLIGHT - HANDS FREE LIGHTING!

- 250-lumen Bright white LED
- Rear red night vision/hazard light
- 12 Neodymium magnets to aim light at many angles
- Use as a pick-up tool
- 4 mode button switch
- Weather resistant

989350



FLEXIT POCKET LIGHT

- 400 and 650 True Lumens
- Center CREE LED spotlight
- Flood LEDs for area lighting
- Red flood LEDs to preserve night vision
- USB-C rechargeable
- 2000mAh(4.0) and 3350mAh(6.5) 18650 Li-ion battery included
- Weather resistant
- Lightweight at only 4.7oz (133g) battery included

SIZES	PART #
4.0 - 400 Lumens	989351
6.5 - 650 Lumens	989352



FLEXIT 2.0 - 200 LUMEN FLEXIBLE FLASHLIGHT

- Fully flexible body 3D
- 200 lumens
- Non-marring rubber magnetic base
- Shape-Loc frame
- 4 light modes
- Weather resistant

989353



RISK RACING FLEXIT SOLAR FLEXIBLE FLASHLIGHT 500 LUMENS/SPOT

- 500 lumens
- Center CREE LED spot light
- Dual charging via solar panel or micro-USB
- Red night reading LEDs
- Fully flexible body
- Non-marring rubber magnetic durable base
- Shape-Loc frame
- 5 light modes
- Weather resistant



989338



RISK RACING MPI - MULTI POINT MOTION ACTIVATED LIGHTING SYSTEM

The MPI creates five points of light, all from your existing fixture! These 5 points spread light to all corners of the room, filling the entire space and reducing shadows caused by single-point illumination. This system installs in minutes and is powered by a standard ceiling fixture, eliminating the need to hire an electrician to properly light large spaces like a garage, attic, or basement.



989339

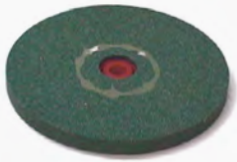

RISK RACING TRILIGHT MOTION ACTIVATED CEILING LIGHT

The TRILIGHT motion sensing LED ceiling light replaces the dim light bulb typically found in your garage, basement or utility room. Upgrading to 4000 TrueLumens Bright White LED light and motion activation is as easy as screwing in a light bulb! Now with adjustable motion sensitivity!



989340



RISK RACING MOBILE TASK LIGHT - RECHARGEABLE

- 1200 lumens
- Dual focus lens
- Dual Lithium-ion battery technology
- Micro-USB Rechargeable
- 4 light modes (high, medium, low, strobe)
- Battery level indication, via button when The Mobile Task Light is turned off
- Adjustable Aluminum Head
- Steel ExoSkeleton
- Hanging Hooks
- Universal camera tripod mount



989342



RISK RACING TRILIGHT SHOPLIGHT V2

- 5000 True Lumens from 3 adjustable aluminum heads
- Transform from a 360° drop light into a single direction shop light
- Built to handle the wear and tear of a demanding work environment
- Cool to the touch LED heads with 50,000-hour LED lifespan
- Hang or prop up for hands-free use



989343



RMSTATOR®
THE POWER IN POWERSPORTS

**VOLTAGE PEAK READING
ADAPTER DVA ADAPTER**



A DVA adaptor is also known as a peak reading adaptor. Small engine ignition systems use permanent magnets to make electricity. This electricity travels down the wires very quickly and in “spikes” so to speak. What a DVA does is capture those “spikes” and allows a standard digital multimeter to read those voltages. Without a DVA adaptor, a multimeter will either record a low voltage, or no voltage at all. Power sport ignition systems work on “peak” voltages, which is why a DVA is known as a “peak reading” adaptor. Multimeters read average voltages, not peak, so that is what our adaptor allows you to do.

223648



**PROFESSIONAL GRADE
RATCHET WIRE CRIMPING
TOOL PLIERS - 9 IN.**

- Position 1: 0.5 to 1.0 mm
- Position 2: 1.5 to 2.5 mm
- Position 3: 4.0 to 6.0 mm
- Suitable for insulated terminals.

223649

UNIVERSAL FLYWHEEL PULLER



- Main Base Diameter: 76 mm
- Thickness: 10 mm
- Inner height : 24 mm

223653

CONNECTOR KIT



- OEM# 3430-053
- Direct replacement to your original connectors
- Included Items:
 - (1) 3-Pin connector
 - (1) 4-Pin connector
 - (3) Female spade quick splice crimp terminals
 - (3) Male spade quick splice crimp terminals
 - (8) Male wire terminals
 - (8) Rubber connector seals

*Connector Kit for Arctic Cat 500
Prowler 650 | Suzuki Eiger 400*

223677

*Connector Kit for Arctic Cat / Honda
/ Kawasaki / Suzuki / Yamaha ATV &
UTV & Motorcycle 1998-2024*

223696

RMSTATOR®
THE POWER IN POWERSPORTS

**UNIVERSAL REGULATOR
RECTIFIER CONNECTORS KIT**



- OEM# 710000870
- Included Items:
 - (2) 3-Pin connectors
 - (6) Female spade quick splice crimp terminals
 - (7) Rubber connector seals

223684

**REGULATOR RECTIFIER
CONNECTOR KIT**



- OEM# 31600-MZ5-003
- Included Items:
 - (1) 3-Pin connector
 - (1) 4-Pin connector
 - (7) Female spade quick splice crimp terminals
 - (7) Male spade quick splice crimp terminals

223704

**UNIVERSAL AUTOMATIC IP65
SMART BATTERY CHARGER 12V /
5A / 100W**



- Battery Type Diversification: Our 12V 5Amp car battery charger is designed for charging car/motorcycle/marine starter/lawn mover batteries such as Pb/SLA/VRLA/GEL/AGM Lead acid battery
- Long battery life: Utilize latest digital power supply technology with programmed MCU controller, it is fully automatic smart charger, using a timer while top charging voltage without overheat and overcharge, maximum your battery life.
- MCU controlled: 12V 5Amp is a 100W smart battery charger by MCU controlled with 4 stage fully automatic charging process for added precision timer.
- IP65 waterproof: The waterproof cover makes you use the charger everywhere.
- Like all Battery chargers, once the battery has reached a 100% charge, its output voltage goes to a safe, storage/float level that eliminates the need to worry about the damaging effects of overcharging. If/when the battery voltage drops too far under load, output power will begin again bringing you battery back to a fully charged state.
- Reversed Hook-up Protection
- Sparkproof
- Quick Disconnect Harness
- All products are tested

224648

**11 PCS CONNECTOR TERMINAL
REMOVAL / PIN PULLER
EXTRACTOR TOOL**



- Designed to remove vehicle wire terminals without damage
- 11 different extractor keys included
- Suitable for most of terminals
- Lightweight, portable, helps you do the work quickly and easily
- All products shipped are tested

224650

196-PIECES CONNECTOR KIT REPLACEMENT



This kit includes:

- 10 x 1-Way Male Connector Receptacle Housing Kit - Natural (P/N: 6187-1171)
- 10 x 1-Way Female Connector Plug Housing Kit - Natural (P/N: 6180-1181)
- 10 x 2-Way Male Connector Receptacle Housing Kit - Natural (P/N: 6187-2171)
- 10 x 2-Way Female Connector Plug Housing Kit - Natural (P/N: 6180-2181)
- 8 x 4-Way Male Connector Receptacle Housing Kit - Natural (P/N: 6188-0004)
- 8 x 4-Way Female Connector Plug Housing Kit - Natural (P/N: 6180-4771)
- 8 x 6-Way Male Connector Receptacle Housing Kit (P/N: 6188-0209)
- 8 x 6-Way White Female Connector Plug Housing Kit (P/N: 6189-0368)

224752

UTV DUAL BATTERY ISOLATOR CONNECTION AND METERING KIT



- Dual battery isolator relay
- 12" Black ground battery cable with terminal lugs
- 12" Red positive battery cable with terminal lugs
- 18" Red positive battery cable with terminal lugs
- Dual Red LED voltmeter (1.4" OD x 1" depth)
- Keyswitch voltmeter activation relay with socket and wires
- 96" wire harness for dual voltmeter connection to relay
- Terminals and connectors

225134

SPLYT TECHNOLOGY

Unmatched Reliability.
Extreme Electrical Power.
No Battery Backup Required.



SPI TERMINAL REMOVAL TOOL KIT



- Designed for use on wire harness electrical connectors for removal of wires from plastic housing
- Individual handles for access in tight places
- Terminal removal kit contains 12 pieces for use on round and flat terminals

129833

SPI PISTON RING COMPRESSOR TOOL KIT



- Is a specialized tool designed to compress piston rings for easier insertion into cylinders during engine assembly or repair
- Featuring a manual ratchet lever for controlled tightening and a quick-adjust ratcheting gear design to hold the tension band.

127322

SPI LEAK DOWN TESTER



- For 4-Stroke, 10, 12, & 14mm spark plug thread hoses.

128622

SPI HEAVY DUTY TRACK CLIP TOOL



- New version of KX0414913 with heavy handle designed not to bend under pressure
- For use with narrow clips (.750")

62414913

SPI HOSE BENDER 1" O.D. HOSE



- Length: 119.2mm. Width: 31.5mm. Fit O.D. 1" fuel line. Material: abs

128181



SPI SYTHON HOSE

- Siphon liquids fast with the Sython Hose!
- Just shake to start the transfer
- 6 ft. hose
- Display packaged

62-07030



SPI EXHAUST SPRING TOOL

- Push/pull capable exhaust spring tool
- * Neoprene coated handle * Length (excluding handle) 6-3/4"
- Sold Each

6212206



SPI DISPOSABLE NITRILE GLOVES

- SPI Disposable Nitrile Gloves
- Powder blue
- Size SMALL, MEDIUM, LARGE, X-LARGE
- 100 count box

SIZES	PART #
SMALL	62274
MEDIUM	62275
LARGE	62276
X-LARGE	62277

SPI UNIVERSAL TRACK CLIP TOOL



- Indispensable in your repair shop
- Ideal for installation of track clips for all types of tracks
- Replaces Ski Doo # 529-0045-00 (can be used on multiple brands)
- Fits most 1" and 1.5" clips

575800

NO IMAGE
AVAILABLE ONLINE

SPI COLD/UV RESISTANT CABLE TIE - 100 PACK

- Cable ties, cold/UV resistant. 100 pack

SIZES	PART #
6" - 100PK	129196
8" - 100PK	129197
10" - 100PK	129198
15" - 100PK	129199

SPI EXHAUST SPRING TOOL ROUND HANDLE



- Designed for removing and installing exhaust pipe springs, tank or seat holdings, and other components with difficult-to-access springs or cotter pins. It features a coated, easy-grip handle for comfortable use and a nickel chrome-plated hook for durability and effective spring engagement.

621162



SPI SHOCK ADJUSTMENT TOOL

- Designed for precise adjustment of shock absorber collars, particularly for motorcycles, with compatibility for collars ranging from approximately 35mm to 75mm. It features a hook and jaw design for a secure grip, a durable construction of high-quality steel and PVC, and a hole for easy storage.

62-12054



SPI CHAIN POCKET SAW

- 33 cutting teeth between nylon handles to make quick work of trees any wooden obstacles.
- 24" chain packs neatly away in nylon pouch.
- 24" blade length 33 cutting teeth.
- Nylon hand loops.
- Nylon carrying pouch

1101064



SPI DOUBLE FOLDING SHOVEL

- Tempered Forged Steel Blade with Saw Edge
- Ergonomic Designed D-Shaped Handle
- Length Open: 22.5" (57mm)
- Length Folded: 9" (23cm)
- Storage Bag Included

125229



SPI PISTON RING INSTALLER

- Save by reducing ring breakage.
- Handles all piston rings from 3/64in. to 1/4in
- Comes with PVC coated handles.
- Made in USA

127323





DRIVE CLUTCH HOLDING TOOL



- This premium tool offers the proper method to hold the drive clutch from rotating while removing or torquing the clutch center bolt. Unlike other clutch holding tools that are laser cut, this tool will not hard-mark or damage the clutch, making it a far more superior tool. It also features a cushion grip for comfort. This tool is a must for quick and easy clutch removal.

SP20202



PISTON PIN PULLER

- Remove or install piston wrist pins easily with this puller from SLP. The body of this puller is made of a special high strength composite which eliminates marking, scarring or distortion of the piston. The face of the body of this puller is specially designed to bridge recessed wrist pin bosses found on late model pistons in order to provide a straight, precise pull each and every time. It is provided with three different sizes of nuts, which fit wrist pins from 15mm thru 24mm.

SP20181



UNIVERSAL HEAVY DUTY FLYWHEEL PULLER

Pull those tough flywheels with ease with this SLP built puller. Strong and built to last for years. This puller is designed with specially shaped slots that allow its use on all two-stroke snowmobile flywheel bolt patterns. The puller includes high quality grade 10.9 bolts, six 6mm and four 8mm.

SP20205





SUSPA CLAMSHELL PROP



- SUSPA COVERED TRAILER GAS PROPS
- Black painted finish.
- 922mm extended length.
- 410mm stroke.
- 13mm zinc plated ball socket ends.
- Gas charged.
- Shock only - no mounts.
- 10' OEM - 138 lbs.

SIZES	PART #
10' - 138#	C16-17856
12' and 10' - 154#	C16-19225
12' - 185#	C16-22632

THREADED 13MM BALL STUD



- SUSPA 13MM BALL STUD.
- Sold each.

C16-17857



TIER A PUMP

TRFA01-XL-CH-ETHANOL/ METHANOL FUEL TRANSFER PUMP



- Flow Rate of 2.3 GPM - Auto-Stop Overfill System
- Water-Resistant Power Buttons
- Intake Tube: 23 inch - Discharge Hose 51 inch
- 4pk of Adapters: Compatible with VP Racing, Midwest Can, No-Spill Can, and more

877003

TREDRUM-M - METERED ELECTRIC DRUM PUMP TELESCOPIC

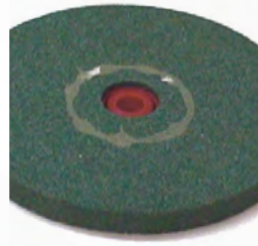

- Power: Electric 110V to 20V DC Adapter, Included
- Flow Rate: 7.1 Gallons per Minute
- Digital Oil Meter: Electric Fuel Meter for precise flow rates
- Suction Tube: 33.5 to 49 inch
- Discharge Hose: 79 inch + 11.5 inch Nozzle
- Compatible Liquids: Diesel, DEF(AdBlue), non-potable water, kerosene, antifreeze, windshield washer fluid, mild detergents, agricultural chemicals & light engine oil

877005

TREDRUM-T - ELECTRIC DRUM PUMP TELESCOPIC



- Power: Electric 110V to 20V DC Adapter, Included
- Flow Rate: 7.1 Gallons per Minute
- Suction Tube: 33.5 to 49 inch
- Discharge Hose: 79 inch + 11.5 inch Nozzle
- Compatible Liquids: Diesel, DEF(AdBlue), non-potable water, kerosene, antifreeze, windshield washer fluid, mild detergents, agricultural chemicals & light engine oil

877006

TRD490N - LEVER ACTION BARREL DRUM PUMP



- Power: Lever-Action (Manual)
- Flow Rate: 10oz per Stroke
- Suction Tube: 18 inch to 33 inch
- Discharge Spout: 4.25 inch
- Compatible Liquids: Oil based fluids, heating oils, motor oils, heavy & light oils, diesel & kerosene

877007

TREPO1-T TELESCOPIC BATTERY POWERED PUMP



- Power: 2x (D) Batteries, Sold Separately
- Flow Rate: 2.6 Gallons per Minute
- Suction Tube: 15 to 20.5 inch
- Discharge Hose: 3.3 ft. Vinyl Hose + 12.4 inch Nozzle
- Compatible Liquids: Gas, Diesel, DEF, Non-Potable Water, Kerosene, Antifreeze, Windshield Washer Fluid, & Agricultural Chemicals

877008

TREPO1-TXL BATTERY POWERED FUEL TRANSFER PUMP WITH 10" HOSE



- Power: 2x (D) Batteries, Sold Separately
- Flow Rate: 2.3 Gallons per Minute
- Suction Tube: 15 to 20.5 inch
- Discharge Vinyl Hose: 120 inch + 12.4 inch Nozzle (Tear-Resistant)
- Compatible Liquids: Gas, Diesel, DEF, Non-Potable Water, Kerosene, Antifreeze, Windshield Washer Fluid, & Agricultural Chemicals

877009

TRJ5XLR - GALLON JUG AND PUMP COMBO



- Power: 4x (AA) Batteries, Sold Separately
- Flow Rate: 2.3 Gallons per Minute
- Suction Tube: 23 inch
- Discharge Hose: 51 inch or 4.25 ft
- Compatible Liquids: Racing Fuels

SIZES	PART #
3 GALLON	877011
5 GALLON	877012



TRFA01 - BATTERY POWERED FUEL TRANSFER PUMP - UPGRADED MODEL

- Power: 4x (AA) Batteries, Sold Separately
- Flow Rate: 2.7 Gallons per Minute
- Suction Tube: 18.1 inch
- Discharge Hose: 39.4 inch
- Compatible Liquids: Gas, Kerosene, Diesel, e15 to e85, & Non-Potable Water

877013

TRFA03 - BATTERY POWERED FUEL TRANSFER PUMP WITH POWER NOZZLE



- New nozzle design
- Built-in Universal threaded adapter
- Power: Four (AA) Batteries, sold separately
- Flow Rate: 2.6 Gallons per Minute
- Suction Tube: 18"
- Discharge Hose: 39"
- Compatible Liquids: Gasoline, E15, E85 (Remove pump after use, E85 may corrode seals), diesel, kerosene & non-potable water

877014

TRFA03-XL - BATT POWERED FUEL TRANSFER PUMP W/ POWER NOZZLE



- Power: 4x (AA) Batteries, Sold Separately
- Flow Rate: 2.3 Gallons per Minute
- Suction Tube: 23.4 inch
- Discharge Hose: 51.2 inch
- Compatible Liquids: Gasoline, E15, E85 (Remove pump after use, E85 may corrode seals), diesel, kerosene & non-potable water

877015

TERAPUMP TRFA01-XL- FUEL TRANSFER PUMP W / EXTENDED HOSES



- Power: 4x (AA) Batteries, Sold Separately
- Flow Rate: 2.5 Gallons per Minute
- Suction Tube: 23.4 inch
- Discharge Hose: Upgraded Vinyl Hose, 51.2 inch
- Compatible Liquids: Gas, Kerosene, Diesel, e15 to e85, & Non-Potable Water

877016



5.5 GALLON MOTORSPORTS CONTAINERS

VP Sportsman's Containers are made with only the highest quality virgin high-density polyethylene, including 30% more material than standard containers to withstand the roughest treatment. The containers are subjected to a 15-point quality test and carry a 3-year limited warranty. They feature an ergonomically contoured handle, bottom grip for easy pouring and a non-breakable multipurpose cap with rubber gaskets.

Excellent for storage & transport of:

- Water
- Automotive & industrial fluid
- Deer corn, milo & oats
- Feed pellets, bird seed
- Rock salt
- Oil & liquid absorbents

Great for mixing/ dispensing:

- Animal attractants & feed
- Herbicides, insecticides



COLORS	NON- CALI PART #	CALI PART #
RED	650637	650819
WHITE	650636	650821
BLUE	650638	650822
YELLOW	650661	650823
GREEN	650662	650824
ORANGE	650663	650825
BLACK	650693	650826
CAMO	650659	650828
BLACK/ ORANGE	650692	650829

CALIFORNIA COMPLIANCE

Due to restrictions on the sale of containers in California, Automatic Distributors has updated part numbers for VP Racing containers. The products will remain the same, apart from different verbiage on the bottom of the cans. There is no change for the caps, vents or hoses. These new Cali part numbers can be sold everywhere and are no-longer considered restricted in the state of California. The chart below indicates the old part numbers on the left, and the new numbers to the right which are under the CALI column.



HOSE SOLD SEPARATELY

GET BENT HOSE BENDER



- Fill your container or tank with greater efficiency thanks to Get Bent's unique design, which bends the hose perfectly and helps prevent wasteful spillage.
- Easy to install and fits standard 1" hoses.
- Fits both VP Racing containers and jugs and can be used to refuel cars, trucks, dirt bikes, mowers and more.
- Equipped with a convenient X-shaped jug opener/closer attachment. No more scrambling to find the right tool to open and close your jug!
- If you use the VP Hose-Deluxe to refuel, you can easily secure hose' white cap to the X-shaped attachment while pouring. This is particularly useful when you're refueling watercraft on open water.

650865

ALUMINUM MOTORSPORTS/ JUG/CAN HOLDER



- Keep your utility jugs, gas cans, watering cans, or other containers neatly stored with this 2-jug bottomless storage rack
- Fits 2 VP Racing Motorsports 5.5-gallon containers or other similar-sized storage containers
- Easily mount to your garage, shop, or shed wall with its pre-drilled holes (screws and mounting hardware not included)
- Made of sturdy aluminum with the VP Racing logo cut out on the front
- Measures approximately 23 inches long, 11.5 inches wide, and 10 inches tall

650864

TRIGGER FLUID CONTROL SYSTEM FITS VP/LC/PIT POSSE/MATRIX JUGS



700001

- Ergo push button operation
- No-spill design
- Variable fluid flow rate control
- Self venting
- Over 3 gallons per minute flow rate
- High quality materials
- Manufactured and assembled in the USA
- Fits VP/LC/PIT POSSE/MATRIX JUGS

REPLACEMENT PARTS



DELUXE CONTAINER HOSE

650643



CONTAINER CAP

650644



HOSE STANDARD CONTAINER

650684



CONTAINER VENT CAP

650645



COLORS	CALI PART #
RED	650831
WHITE	650832
BLUE	650833

MOTORSPORTS CONTAINERS

3-GALLON CONTAINERS

- Ergonomically contoured handle and bottom grip for easy pouring
- Extra large cap with rubber o-ring gasket
- Made from virgin density polyethylene
- Adjustable screw on air vent
- Containers have accurate graduated marks indicating gallons and liters
- 3 gallon capacity
- Hose sold separately (Part #650643 & 650684)
- Three year warranty



HOSE SOLD SEPARATELY

PINK VPSQ 5.5 GAL MS CONTAINER



- Close Trimmed Cap And Neck For Tighter Seal
- Ergonomic Handle For Better Venting
- Modified Cap For A Better Seal
- Super Wide Hand Grip On Bottom Of Jug
- Even Density Plastic For Critical Areas Like Corners
- 30 Percent More Product Per Pallet With New Space Saving Case Pack Configuration
- Limited 3 Year Warranty

650827

PATRIOTIC VPSQ 5.5 GAL MS CONTAINER



- Close Trimmed Cap And Neck For Tighter Seal
- Ergonomic Handle For Better Venting
- Modified Cap For A Better Seal
- Super Wide Hand Grip On Bottom Of Jug
- Even Density Plastic For Critical Areas Like Corners
- 30 Percent More Product Per Pallet With New Space Saving Case Pack Configuration
- Limited 3 Year Warranty

650820





TRACK CLIP TOOL



- Tool can be used while track is still on sled.
- Only 2 piece unit.
- Top is made of case hardened 1018 steel.
- Anvil is made of 6061 T6 tempered aluminum with a hardened steel ball locked in for the bolt to press on.
- Anvil is locked in by two hardened shoulder bolts; worry free from falling out or getting cocked.
- Drive bolt is grade 8 and is designed to fit perfectly on the anvil ball.
- Base plate is made of 5/16 hot rolled steel, laser cut, fitted with rubber grips to hold the bolts snug and is cut with clearance for guided track clips.

214109

SHARPENING WHEEL

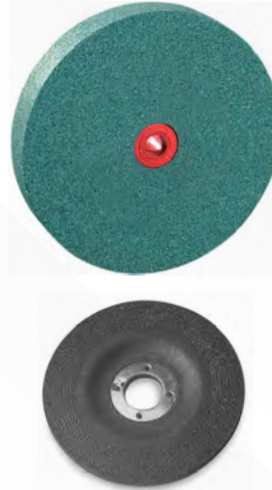

- Specially designed grinding wheel for sharpening carbide runners and studs
- Helps maintain sharp edges and points and can be used to alter stud point angles
- Can be used on any hand or bench grinder with either a 1/2" or 1" arbor shaft
- Not recommended for general grinding

SIZES	PART #
1" X 6" GREEN	AGW4100
1/4" X 4 1/2" BLACK SILICON	AGW4500

HEX INSERT STUD



- Use this tool for installing and removing push-through studs
- The handle is made from premium aluminum
- Each tool comes with an extra hex bit
- A replacement hex package is also available that contains two hex bits

SHI-2

STUD INSTALLATION TOOL STUD



- A great new tool for installing studs made for all Woody's studs
- The aluminum handle rests in the palm of your hand so you can apply pressure needed to keep the stud from rotating as you torque the nut
- Each tool comes with two hex bits

SHT-1

TRACK DRILL TOOL 7M 5/16"



- Perfect every time makes studding easy
- Hollow drill for 7mm or 5/16in. studs makes a precise opening for installing studs
- For 7mm T-nut studs and 5/16in. push-through studs use 7mm drill

TC7

TRACK TENSION TOOL



- Optimize performance and prolong the life of the track, by properly maintaining it with this handy tool
- Allows you to set the weight and measure the tension of the track; ensuring that you match the OEM recommendations

WD035



TRACK MARKER

- Use the track marker and a template to plan the layout of any stud pattern
- An easy way to see how your pattern is developing
- White dots from marker facilitate hole placement

WD040



SQUARE SUPPORT PLATE TOOL

- Attach the tool directly to a standard 3/8in. ratchet; align the support plate flush with the track lugs and then tighten the nut.
- Aligning the support plates can contribute to track longevity and your safety.
- The indexing tool is available for 5/16", 7mm and 5.16 square support plates.

SIZES	PART #
5/16"	WD045
7MM	WD047

woody's®





DISTRIBUTED BY
AUTOMATIC
DISTRIBUTORS

We are a top national wholesale distributor, offering an extensive selection of over 350 of the best brands in high-quality parts and accessories for the power sports market.

www.autodist.com | 207-942-6769 | custserv@autodist.com

TIRES & TRACKS

TUBES

CHEMICALS

TOOLS

BATTERIES

FUEL & INTAKE

AIR & OIL FILTERS





TABLE OF CONTENTS

BATTERY TENDER	432-439
NOCO	440-447
TYTANEUM	448-453
YUASA	454-465
ANTIGRAVITY BATTERIES	466-469
EMGO	470
ALL BALLS RACING	471-473



LOW POWER BATTERY CHARGERS // 0.75A - 5A

BATTERY TENDER® JUNIOR 12V @ 0.75A

The Battery Tender® Junior is much more than a trickle charger. It has a brain. It's lightweight, compact, and fully automatic; very easy to use, especially in small spaces. It will keep your battery fully charged so that it is ready to go when you are!



- Perfect for all lead-acid, flooded or sealed maintenance free batteries (AGM and gel cell).
- Complete 4-step charging program (Initialization, Bulk Charge, Absorption Mode, Float Mode).
- Automatically switches to float / maintenance voltage after fully charging the battery.
- If the battery voltage drops too far under load, full charger output power resumes.
- Solid state two color LED indicates stage of charger.
- Spark proof.
- Reverse polarity protected.
- 12' output cord.
- 5 year warranty

MFG #	OUTPUT	INPUT	CASE QTY	PART #
021-0123	12V-0.75A	120V/60Hz	12	DL0123
022-0196	6V-1.25A	120V/60Hz	6	462010

JUNIOR 12V 800 SELECTABLE LEAD ACID/ LITHIUM CHARGER

The Battery Tender® Junior 800 is much more than a trickle charger. It has a brain. It's lightweight, compact, and very easy to use, especially in small spaces. With selectable battery type, it will keep your battery fully charged so that it is ready to go when you are!



- Charger weight: 1 lb.
- Size: 4" x 2" x 1.37"
- Plugs directly into the wall
- ISM™ microcontroller constantly updates charge sequence for smooth transitions between charging steps
- Spark proof
- Short circuit protected
- Reverse hook-up protection
- Selectable for AGM, flooded, GEL, or lithium (LiFePO4)
- Lead acid safety timer: 80 hrs.
- Lithium safety timer: 18 hrs.
- Certification: BC, FCC.
- 5 year warranty

MFG #	OUTPUT	INPUT	CASE QTY	PART #
022-0199-DL-WH	12V-800mA Selectable AGM/ Lithium	120V 50/60Hz	6	462007

WATERPROOF 800 INTERNATIONAL

This compact 800 mA battery charger has all the charge characteristics of its cousin the Battery Tender® Junior. It incorporates highly efficient surface mount technology electronic components. The interior is completely encapsulated, protected from shock, vibration, and moisture by an electrically insulating, thermally conductive, flame retardant, synthetic epoxy resin compound. It's tough, affordable, and a strong, innovative battery charging solution. This charger is no larger than a standard computer mouse yet packs 800 millamps of pure constant current charging power. Coupled with a brain (IC chip), the charger will constantly monitor, charge, and then maintain your battery --- even while totally submerged under water! Perfect for all outdoor types of ATV's, watercraft, motorcycles, boats, or anywhere water is a threat. International universal input voltage works anywhere in the world 100-240 AC Volts 50/60 Hz.



- "Supersmart" Technology
- Spark Proof
- Short Circuit Protected
- Reverse Polarity Protected
- Waterproof
- Weighs only 1 lb
- 3 Year Warranty

MFG #	OUTPUT	INPUT	CASE QTY	PART #
022-0150-DL-WH	12V-0.8A	120V 60Hz	12	DL0150

BATTERY TENDER® PLUS

The Battery Tender® Plus is a 1.25 amp battery charger designed to fully charge a battery and maintain it at proper storage voltage without the damaging effects caused by trickle chargers. Included is a quick connect ring terminal harness for hard to reach areas and alligator clips for an alternate connection.



- Temperature compensated to ensure optimum charge voltage according to ambient temperature.
- Automatically switches from full charge to float charging mode.
- Battery Tender® at 1.25 amps will charge as fast or faster than any 3 amp charger available.
- Reverse Polarity Protection to ensure user safety. Red & Green Lights Alternately Flash in this condition.
- Complete 4-step charging program (Initialization, Bulk Charge, Absorption Mode, Float Mode).
- 10 year Warranty!

MFG #	OUTPUT	INPUT	CASE QTY	PART #
021-0128	12V-1.25A	12V/60Hz	12	DL9012



LOW POWER BATTERY CHARGERS // 0.75A - 5A CONTINUED

BATTERY TENDER PLUS HIGH EFFICIENCY

Battery Tender Plus 12V, 1.25 Selectable 6/12V. The Selectable Plus is strong enough to off set the drain keeping your battery at peak performance!

Vehicles on the roads today come standard with more electronics, meaning a heavy voltage draw from your battery. Even with your car turned off, these electronics will pull voltage from your battery.



- Reverse Polarity Protection to ensure user safety.
- Complete 4-step charging program (Initialization, Bulk Charge, Absorption Mode, Float Mode).
- Perfect for all lead-acid, flooded or sealed maintenance free batteries (AGM and gel cell).
- Safety timer: 72 hours
- Listed in California Appliance Efficiency Database
- Agency Approvals: UL / CSA / BC / FCC
- 5 year warranty

MFG #	OUTPUT	INPUT	CASE QTY	PART #
022-0211-DL-WH	12V-6V-1.25A	12V 50/60Hz (220-240V Available)	12	462011

BATTERY TENDER PLUS 3A

The Battery Tender® Power Plus is a 3 Amp battery charger that will fully recharge and then maintain a battery at its proper storage voltage without the damaging effects caused by trickle chargers. A higher output (3 amps) than the original Battery Tender Plus for a quicker recharge on Automotive, Marine, and Power Sport batteries combined with the automatic switch to maintenance mode makes this unit very versatile. It is an ideal charger for everyday charging use or long-term storage and maintenance. Ideal for AGM, Flooded, and Gel batteries.



- Reverse Polarity Protection to ensure user safety.
- Spark Proof
- Short Circuit Protected
- Complete 4-step charging program (Initialization, Bulk Charge, Absorption Mode, Float Mode).
- Perfect for all lead-acid, flooded or sealed maintenance free batteries (AGM and gel cell).
- Safety timer: 33 hours
- Listed in California Appliance Efficiency Database
- Agency approvals: UL / CSA / RoHS / BC / FCC
- 5 year warranty

MFG #	OUTPUT	INPUT	CASE QTY	PART #
022-0202-COS-WH	12V-3A 6V-3A	120V 50/60Hz	12	462012

BATTERY TENDER PLUS 4A

Quickly Charge Lithium and Lead Acid Batteries. The fully automatic 4 Amp Power Tender is a top-of-the-line 12V or 6V switchable battery charger, perfect for automotive, motorcycle and marine repair and maintenance shops.



- Selectable for AGM/Standard/GEL or Lithium (LiFePO4) *12V only for Lithium
- ISM™ (Infinite Sequential Monitoring) of the fully automatic 4-step charge process (qualification, bulk charge, absorption, float)
- Microprocessor controlled
- Spark proof even when output leads touch.
- Reverse Polarity Protection - no charge or battery damage
- State of charge LED indicators
- Includes Rings & Clips
- Shipping Weight: 3.15lbs
- Dimensions: 6.8" x 3.68" x 1.96" (charger only)
- Lead acid safety timer: 25 hrs.
- Lithium safety timer: 15 hrs.
- 5 year warranty

MFG #	OUTPUT	INPUT	CASE QTY	PART #
022-0209-BT-WH	12V-4A 6V-4A Lead Acid / Lithium	120V 50/60Hz	4	462013

BATTERY TENDER PLUS 5A

The 5 amp 12 volt Battery Tender charger is a fully automatic High Frequency switch mode charger. It has 4 stage charging (Qualification, bulk, absorption and float) When the recharge is complete the charger will float (maintain) the battery for an extended period of time at full state of charge. It is specifically designed for AGM batteries but will easily recharge all lead acid batteries from the small Powersports batteries up to and including large deep cycle batteries for automotive, marine, agriculture, construction, virtually any lead acid battery. It is completely safe and includes a 72 hour timer to prevent further damage to marginal batteries. It is fully approved for the California and Oregon markets. It is a smart charger that you just put on and leave on until you are ready to use the vehicle.



- 4-Step Fully Automatic Charging (Initialization, Bulk, Absorption, Float) Automatically switches to float / maintenance voltage after fully charging the battery.
- Perfect for all lead-acid, flooded or sealed maintenance free batteries (AGM and Gel Cell)
- Spark Proof
- Short Circuit Protected
- Reverse Polarity Protected
- Safety timer: 72 hrs
- Listed in California Appliance Efficiency Database
- Agency Approvals: UL / CSA / BC / FCC
- Dimensions: 3.99W x 8.26L x 2.34H
- AC Power Cord Length: 6 ft. - 18AWG
- DC Output Cord Length 4.5 ft. - 18AWG
- DC Accessory Length 1.5 ft.
- Weight: 3.0 lbs.
- Warranty: 5 Years

MFG	OUTPUT	INPUT	CASE QTY	PART #
022-0186G-DL-WH	112V-5.0A	120V 50/60Hz (240V Available)	12	462014



LOW POWER BATTERY CHARGERS // 0.75A - 5A CONTINUED



BATTERY TENDER® POWER TENDER

This advanced Battery Tender 5A is microprocessor controlled by BTP Technology. It is water resistant and vibration resistant. It charges both flooded and sealed maintenance free lead acid batteries of any capacity.

With the automatic four-step charging program (Initiation, Bulk, Absorption, and Maintenance), you can charge your battery with ease and are always ready to go.

Battery Tender(R) assures the highest quality, fast-charging convenience and performance. The choice of collectors, dealers, and fleet owners, our state-of-the-art chargers can actually save hundreds of dollars in replacement batteries!

MFG #	OUTPUT	INPUT	CASE QTY	PART #
022-0258	12V-5.0A 24V- 2.5A Standard Lithium- AGM	120V 50/60Hz	6	462015

MULTIPLE OUTPUT BATTERY MANAGEMENT SYSTEMS

4 BANK INTERNATIONAL CHARGER

The 4 Bank Battery Tender Charging Station is four enclosed 1.25 amp battery chargers designed to fully charge a battery and maintain it at proper storage voltage without the damaging effects caused by trickle chargers. This charger will operate anywhere in the world!

- 4 independent charging stations
- 12 volts @ 1.25 amps per station.
- Extremely lightweight! Less than 3 lbs!
- Operates anywhere in the world! 100-240
- VAC 50/60 Hz.
- 25 ft leads available (NOT INCLUDED)
- Microprocessor controlled constant current charging!
- Reverse Polarity Protected
- Spark Proof
- Perfect for all AGM (absorbed glass mat), sealed maintenance free and flooded batteries
- Complies with US and international safety standards (UL/CE).
- 2 year warranty!



MFG #	OUTPUT	INPUT	CASE QTY	PART #
022-0148-DL-WH	12V-1.25A	120V 50/60Hz (220-240V Available)	6	DL0148



MULTIPLE OUTPUT BATTERY MANAGEMENT SYSTEMS CONTINUED



5 BANK CHARGER 6V/12V @ 4A

Deltran's advanced SuperSmart Battery Tender® Battery Management System is light years ahead of any standard battery charger. It's the first fully automatic, constant current battery charger designed to charge and/ or maintain up to 5 12volt batteries simultaneously at 4 amps. All Battery Tender® chargers automatically switch from full charge to float charge mode. Suitable for standard & lithium batteries. Each output independently charges at 4Amps. Includes 5 alligator clips with 7.5 foot cable. To prevent/avoid damaging your battery a microchip circuitry will not activate output voltage until the clips are properly connected to the battery. Spark proof and reverse polarity protected. Simultaneously charges and/ or maintains up to 5 batteries at one time. 3 Year Warranty included.

MFG #	OUTPUT	INPUT	CASE QTY	PART #
021-0133-DL-WH	12V/6V-4.0A	120V 50/60Hz (220-240V Available)	1	DL0103

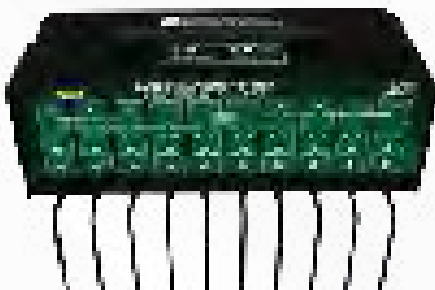

4 BANK INTERNATIONAL CHARGER

Safe, No Spark Charging!

Deltran's advanced SuperSmart Battery Tender® Battery Management System is light years ahead of any standard battery charger. Versatile charging options in one charger. Selectable for AGM/Standard/GEL or Lithium (LifePO4) Batteries. It's the first fully automatic, constant-current battery charger designed to charge and/ or maintain up to 10 12-volt or 6-volt batteries simultaneously @ 4 amps. To avoid short sparking, the microchip circuitry will not activate output voltage until clips are correctly connected to battery. Includes 10 alligator clips with 7.5 foot cable. 3 year warranty included.

MFG #	OUTPUT	INPUT	CASE QTY	PART #
021-0134-DL-WH	12V/6V-4.0A	120V 50/60Hz (220-240V Available)	1	DL0104



JUMP STARTER & PORTABLE POWER PACK

800A JUMP STARTER



- Compact and powerful lithium jump starter 800 amps up to 20 jump starts on a single charge.
- Spark-proof connections and reverse polarity protection. An ultra-bright LED flashlight with with emergency strobe.
- Recharge your personal devices on the go, like smartphones, tablets, e-watches and more.
- Designed for gas engines up to V6 and diesel engines, ideal for cars, SUVs, boats, trucks, ATVs, motorcycles to name a few.
- New Feature: Hot and Cold LED indicators of the internal battery operating temperatures to protect your batteries and devices.
- Includes Alligator Clips designed to easily connect to any 12V lead-acid battery from Powersports to Automotive.

1000A JUMP STARTER

WITH 10W WIRELESS CHARGING



- Rapid 10W Wireless Charger - Qi Based Devices
- Compact & powerful lithium jump starter 1000 amps up to 30 jump starts on a single charge.
- Spark-proof connections and reverse polarity protection. An ultra-bright LED flashlight with with emergency strobe.
- Recharge your personal devices on the go, like smartphones, tablets, e-watches and more.
- Designed for gas engines up to V8 and diesel engines, ideal for cars, SUVs, boats, trucks, ATVs, motorcycles to name a few.
- New Feature: Hot and Cold LED indicators of the internal battery operating temperatures to protect your batteries
- and devices.
- Includes Alligator Clips designed to easily connect to any 12V lead-acid battery from Powersports to Automotive.

MFG #	OUTPUT	INPUT	CASE QTY	PART #
030-1010-WH	800A Peak Current	12V	6	462022

MFG #	OUTPUT	INPUT	CASE QTY	PART #
030-1011-WH	1000A Peak Current	12V	6	462023

ACCESSORIES

SOLAR CONTROLLER

Battery Tender® Solar Controller allows you to convert an existing solar panel into a solar charger using Battery Tender® patented Super Smart Charging Algorithm. Usable input range between 5-45 Watts! 5 -years industry leading warranty.



- 3-Step fully automatic charging (Qualification, Bulk Charge, Float)
- Spark proof
- Reverse Polarity Protection
- State of charge LED indicator
- Input voltage: 32 VDC (Max)
- Input current: 3 ADC (Max)
- Output Current: 3 ADC (Max)
- 5-Year Warranty

For trolling motors and other DC to DC connections.
Includes Plug, Receptacle and Gasket

MFG #	OUTPUT	INPUT	CASE QTY	PART #
027-0004-KIT		Rated for 12v-48VDC @ 80 amps	12	462024



ACCESSORIES CONTINUED

DC POWER CONNECTION RECEPTACLE

Battery Tender® Black Power Connector Receptacle is an onboard receptacle that enables the D/C connector for DC to DC connections. The unique silver-plated solid copper alloy electrical contacts and high impact UV protected

glass-reinforced thermoplastic housing with a lock device provides a positive connection that avoids vibration and water incursion. Come with all stainless-steel hardware. Perfect for battery connections to trolling motors, navigational electronics or any DC accessory.



MFG #	OUTPUT	INPUT	CASE QTY	PART #
224-0061-BK	Rated for 12v-48VDC 12V @ 80 amps		1	462025

PLUG ONLY

Battery Tender Black DC Power Connector L-Shape Plug is an onboard connector for DC to DC connections. Perfect for battery connections to trolling motors, navigational electronics or any DC accessory. The unique screw and lock device provides a positive connection that avoids vibration and water incursion.

- Technical Specification:
- Designed for 12V through 48V
- two wire DC applications.
- Color: Black
- Depth: 3.1
- Height: 1.9
- Width: 2.3



MFG #	OUTPUT	INPUT	CASE QTY	PART #
224-0062-BK	Rated for 12v-48VDC @ 80 amps		1	462026

RING TERMINALS, QUICK DISCONNECT

Battery Tender® Solar Controller allows you to convert an existing solar panel into a solar charger using Battery Tender® patented Super Smart Charging Algorithm. Usable input range between 5-45 Watts! 5-years industry leading warranty.

- Ring Terminal Harness Accessory for use with multiple batteries. Black Quick Disconnect. For 12 volt models only. Contains a 7.5 amp fuse. 2 ft. long.



Black Fused, 2 pin

MFG #	OUTPUT	INPUT	CASE QTY	PART #
081-0069-6		1	12	DL0693



ACCESSORIES CONTINUED

RING TERMINALS, QUICK DISCONNECT

Battery Tender Quick Disconnect Plug with USB Charger 12V Input and Maximum 2.1 Amps Output it's Quite Portable and Perfect for Charging your iPhone, iPad,

- iPod, GPS, Camera or any Smartphone or Device that be Charged via USB. It's Designed for Use on Most 12-Volt Batteries on Your Motorcycle, Golf Cart, ATV, etc. It Attaches to Existing Battery Tender Quick Disconnect. The Rubber Flap will Protect the Charger Connectors.



MFG #	OUTPUT	INPUT	CASE QTY	PART #
081-0158	21A Max 5V	12V	48	DL0120

6 FOOT QUICK DISCONNECT EXTENSION CABLE

- Use the 6 foot long lead extension with the Battery Tender® Junior, Plus, 2, 4, 5, or 10 Bank units. (Not for use with the 6 Volt Battery Tender® Plus or any other Battery Tender® product with white quick-disconnect plugs.)



Black Fused, 2 pin

MFG #	CASE QTY	PART #
081-0148-6	45	462028

DIGITAL VOLTAGE INDICATOR WITH LCD DISPLAY

- Designed for use on 12v Flooded, AGM and Gel batteries. Display voltage range is 3 to 16.



MFG #	OUTPUT	INPUT	CASE QTY	PART #
081-0157		12V	48	DL0119

25 FT. EXTENSION LEAD

- 25 ft. Extension Lead for use to extend the length of the charger's reach from input to battery. (NOT COMPATIBLE WITH 6V BATTERY TENDER® PLUS or any other Battery Tender® product with white quick-disconnect plugs.)



MFG #	CASE QTY	PART #
081-0148-25	12	DL0115
081-0148-25-BG4	(4-pack)	DL0116

12.5 FT. EXTENSION LEAD

- 12.5 ft. Extension Lead for use to extend the length of the charger's reach from input to battery. (NOT COMPATIBLE WITH 6V BATTERY TENDER® PLUS or any other Battery Tender® product with white quick-disconnect plugs.)



MFG #	CASE QTY	PART #
081-0148-12	12	DL0117



ACCESSORIES CONTINUED

CIGARETTE LIGHTER ADAPTOR

- Black
- Quick Disconnect
- 12V models only



MFG #	OUTPUT	INPUT	CASE QTY	PART #
081-0069-5			12	DL0110

FEMALE CIGARETTE ADAPTER

- Female Cigarette Adapter
- Quick disconnect adapter



MFG #	OUTPUT	INPUT	CASE QTY	PART #
081-0069-8			12	DL0111

BATTERY TENDER® CASE

- This zippered carrying case was designed for the Battery Tender® International and is also suitable for the Battery Tender® Plus & Junior units. It's a convenient way to protect your Battery Tender® and accessories from dirt or loss.



MFG #	SIZE	CASE QTY	PART #
500-0017	Small, 4" x 6"	50	462000

BATTERY TENDER® USB WALL CHARGER

- Dual port USB car charger
- INPUT: 12-24V
- OUTPUT: 2.1A for iPad / Tablets, and 1A for all cell phones
- Smart fuse for surge protection
- Use existing USB charge / sync cable for charging (not included)



MFG #	OUTPUT	INPUT	CASE QTY	PART #
022-0194	5V 2.1A Max	120Vac	60	462029



NOCO®

NOCO

NEW POWERSPORTS LITHIUM BATTERIES



INSANE PERFORMANCE. LITHIUM POWERSPORT BATTERY.™

2X MORE POWER. **10X** MORE STARTS. **5X** LONGER LIFE.

DYNAMIC BMS.
Equipped with an auto-enabled, advanced battery management system that provides maximum protection, performance and bi-directional cell equalization for long lasting stability. No BMS reset needed.

ACTIVE PROTECTION.
Protects engine against over-charge, extreme heat, short circuit, over discharge, extreme cold and over-current.

SHOCK ABSORPTION.
Designed with a custom rubber dampening base and foam insert to extend the life of the battery and keep connections secure.



FIT MORE APPLICATIONS THAN EVER BEFORE WITH ADJUSTABLE SIZING • REMOVABLE MOUNTING BLOCK • MODULAR SPACERS

A removable mounting block allows the battery to fit more applications. The threaded insert enables direct-mounting for additional simplicity and security.

Modular mounting spacers can be stacked and attached to the NLP batteries to alter the BCI size enabling the battery to be safely and securely mounted.



NOCO 250A Lithium Powersport Battery

Introducing the all-new NOCO Lithium NLP5 12V Lithium Powersport Battery, a Group 5 battery, rated at 2Ah (25Wh) and 250-amperes of starting power. It's better than lead-acid motorcycle batteries in almost every way: no sulfation, no activation, no acid, no maintenance, no water needed, and it comes fully charged and ready to install.

- Delivers over 250-amperes of starting power, over 50,000 starts, and over 2,000 charge cycles, blowing away its lead-acid rivals. Simply put, it's 2X more power, 10X more starts, and 5X longer life.
- An advanced battery management system that provides maximum safety protection with bi-directional active cell balancing for long-lasting reliability. Plus, no BMS reset is needed.
- Unleash the power of lithium and quickly recharge within minutes. Utilizing the most advanced rapid charge technology, it provides enough starting power with just 5-minutes of charge.
- A multi-terminal configuration that allows front, side, top, and female installations. Plus, modular trays fit various group sizes and a removable mounting block to accommodate legacy battery applications.
- Compatible with most powersport brands, including Aprilia, BMW, Buell, Ducati, Harley-Davidson, Indian, Triumph, KTM, Argo, Can-Am, Honda, Husqvarna, Kawasaki, Suzuki, Arctic Cat, BRP, Waverunner, Polaris, Vespa, and more

MFG #	PART #
NLP5	651117

Replaces lead-acid powersport battery models: BTZ7S, BTZ8V, BTX4L-BS, BTX5L-BS, BTX7L-BS, BTZ5S, YTZ7S, YTZ8V, YTZ5S-BS, YTX4L-BS, YTX5L-BS, and YTX7L-BS.



NOCO 400A Lithium Powersport Battery

Introducing the all-new NOCO Lithium NLP9 12V Lithium Powersport Battery, a Group 9 battery, rated at 3Ah (38Wh) and 400-amperes of starting power. It's better than lead-acid motorcycle batteries in almost every way: no sulfation, no activation, no acid, no maintenance, no water needed, and it comes fully charged and ready to install.

- Delivers over 400-amperes of starting power, over 50,000 starts, and over 2,000 charge cycles, blowing away its lead-acid rivals. Simply put, it's 2X more power, 10X more starts, and 5X longer life.
- An advanced battery management system that provides maximum safety protection with bi-directional active cell balancing for long-lasting reliability. Plus, no BMS reset is needed.
- Unleash the power of lithium and quickly recharge within minutes. Utilizing the most advanced rapid-charge technology, it provides enough starting power with just 5-minutes of charge.
- A multi-terminal configuration that allows front, side, top, and female installations. Plus, modular trays fit various group sizes and a removable mounting block to accommodate legacy battery applications.
- Compatible with most powersport brands, including Aprilia, BMW, Buell, Ducati, Harley-Davidson, Indian, Triumph, KTM, Argo, Can-Am, Honda, Husqvarna, Kawasaki, Suzuki, Arctic Cat, BRP, Waverunner, Polaris, Vespa, and more.

MFG #	PART #
NLP9	651118

Replaces lead-acid powersport battery models: BTX7A-BS, BTX9-BS, BTR9-BS, EXT9, YTX9, YTX7A-BS, and YTX9-BS.



NOCO 500A Lithium Powersport Battery

Introducing the all-new NOCO Lithium NLP14 12V Lithium Powersport Battery, a Group 14 battery, rated at 4Ah (51Wh) and 500-amperes of starting power. It's better than lead-acid motorcycle batteries in almost every way: no sulfation, no activation, no acid, no maintenance, no water needed, and it comes fully charged and ready to install.

- Delivers over 500-amperes of starting power, over 50,000 starts, and over 2,000 charge cycles, blowing away its lead-acid rivals. Simply put, it's 2X more power, 10X more starts, and 5X longer life.
- An advanced battery management system that provides maximum safety protection with bi-directional active cell balancing for long-lasting reliability. Plus, no BMS reset is needed.
- Unleash the power of lithium and quickly recharge within minutes. Utilizing the most advanced rapid-charge technology, it provides enough starting power with just 5-minutes of charge.
- A multi-terminal configuration that allows front, side, top, and female installations. Plus, modular trays fit various group sizes and a removable mounting block to accommodate legacy battery applications.
- Compatible with most powersport brands, including Aprilia, BMW, Buell, Ducati, Harley-Davidson, Indian, Triumph, KTM, Argo, Can-Am, Honda, Husqvarna, Kawasaki, Suzuki, Arctic Cat, BRP, Waverunner, Polaris, Vespa, and more.

MFG #	PART #
NLP14	651119

Replaces lead-acid powersport battery models: BT12A-BS, BTZ14S, BTZ12S, BTX14, BT14B-4, BTX20CH-BS, BTX16-BS-1, B16A-AB, BTX12-BS, BTX14-BS, BTX16-BS, BTZ10S, GYZ16H, YTX14H, YTX20CH, YTZ10S, YTZ12S, YTZ14S, YTX14H-BS, YTX20CH-BS, YTX12, YTX14, YT12A-BS, YTX12-BS, KMX14-BS, YTX14-BS, YTX16-BS, YTX16-BS-1, HYB16A-A, ETX12, ETX14, and ETX14L.



NOCO 600A Lithium Powersport Battery

Introducing the all-new NOCO Lithium NLP20 12V Lithium Powersport Battery, a Group 20 battery, rated at 7Ah (89Wh) and 600-amps of starting power. It's better than lead-acid motorcycle batteries in almost every way: no sulfation, no activation, no acid, no maintenance, no water needed, and it comes fully charged and ready to install.

- Delivers over 600-amps of starting power, over 50,000 starts, and over 2,000 charge cycles, blowing away its lead-acid rivals. Simply put, it's 2X more power, 10X more starts, and 5X longer life.
- An advanced battery management system that provides maximum safety protection with bi-directional active cell balancing for long-lasting reliability. Plus, no BMS reset is needed.
- Unleash the power of lithium and quickly recharge within minutes. Utilizing the most advanced rapid-charge technology, it provides enough starting power with just 5-minutes of charge.
- A multi-terminal configuration that allows front, side, top, and female installations. Plus, modular trays fit various group sizes and a removable mounting block to accommodate legacy battery applications.
- Compatible with most powersport brands, including Aprilia, BMW, Buell, Ducati, Harley-Davidson, Indian, Triumph, KTM, Argo, Can-Am, Honda, Husqvarna, Kawasaki, Suzuki, Arctic Cat, BRP, Waverunner, Polaris, Vespa, and more.

Replaces lead-acid powesport battery models: BTX20HL-BS, B16L-B, BTX15L-BS, BTX20L, B18L-A, BTZ20L, B16CL-B, B50-N18L-A3, BTX20L-BS, BTX15L, GYZ20L, GYZ20HL, YTX20HL, YIX20HL, YTX20HL-PW, YTX20HL-BS, YTX20HL-BS-PW, YIX20HL-BS, YTX15L, YTX20L, YTX15L-BS, YTX20L-BS, YB16HL-A-CX, YB16L-B, YB16CL-B, SYB16L-B, Y50-N18L-A, ETX16, ETX16L, and ETX20L.

MFG #	PART #
NLP20	651120





MFG # PART #
GENIUS1 650560

GENIUS1

1-Amp Fully-Automatic Smart Charger, 6V and 12V Battery Charger, Battery Maintainer, Trickle Charger, and Battery Desulfator with Temperature Compensation

- Similar to our G750, just better - It's 35% smaller & delivers over 25% more power and it's simpler and easier to use than ever before - plug-in, connect to the battery, select a charge mode, & start charging your battery
- Enjoy precision charging - An integrated thermal sensor detects the ambient temperature and alters the charge to eliminate over-charging in hot climates and under-charging in cold climates
- Charge dead batteries - Charges batteries as low as 1-volt. Or use the all-new force mode that allows you to take control and manually begin charging dead batteries down to zero volts
- Beyond maintenance - It's not just a trickle charger, it's an advanced battery maintainer. A fully-automatic, worry-free battery charger for everyday use - 24/7 - with zero overcharge
- Compatible with all types of vehicles - charge and maintain cars, motorcycles, lawn mowers, ATVs, lawn tractors, trucks, SUVs, boats, PWCs, classic cars, and more.
- Specs: 15.2 ounces; 3.43 x 4.02 x 6.73 inches



MFG # PART #
GENIUS2 650561

GENIUS2

2-Amp Fully-Automatic Smart Charger, 6V and 12V Battery Charger, Battery Maintainer, Trickle Charger, and Battery Desulfator with Temperature Compensation

- Similar to our G1100, just better - It's 31% smaller and delivers over 82% more power and it's simpler and easier to use than ever before - plug-in, connect to the battery, select a charge mode, & start charging your battery
- Enjoy precision charging - An integrated thermal sensor detects the ambient temperature and alters the charge to eliminate over-charging in hot climates and under-charging in cold climates
- Charge dead batteries - Charges batteries as low as 1-volt. Or use the all-new force mode that allows you to take control and manually begin charging dead batteries down to zero volts
- Beyond maintenance - It's not just a trickle charger, it's an advanced battery maintainer. A fully-automatic, worry-free battery charger for everyday use - 24/7 - with zero overcharge
- Compatible with all types of vehicles - charge and maintain cars, motorcycles, lawn mowers, ATVs, lawn tractors, trucks, SUVs, boats, PWCs, classic cars, and more
- Specs: 1.23 pounds; 3.43 x 4.25 x 6.97 inches



MFG # PART #
GENIUS5 650562

GENIUS5

5-Amp Fully-Automatic Smart Charger, 6V and 12V Battery Charger, Battery Maintainer, Trickle Charger, and Battery Desulfator with Temperature Compensation

- Similar to our G3500, just better - It's 34% smaller and delivers over 43% more power and it's simpler and easier to use than ever before - plug-in, connect to the battery, select a charge mode, & start charging your battery
- Enjoy precision charging - An integrated thermal sensor detects the ambient temperature and alters the charge to eliminate over-charging in hot climates and under-charging in cold climates
- Charge dead batteries - Charges batteries as low as 1-volt. Or use the all-new force mode that allows you to take control and manually begin charging dead batteries down to zero volts
- Beyond maintenance - It's not just a trickle charger, it's an advanced battery maintainer. A fully-automatic, worry-free battery charger for everyday use - 24/7 - with zero overcharge
- Compatible with all types of vehicles - charge and maintain cars, motorcycles, lawn mowers, ATVs, lawn tractors, trucks, SUVs, boats, PWCs, classic cars, and more
- Specs: 1.59 pounds; 4.61 x 3.43 x 7.95 inches



MFG # PART #
GENIUS10 650563

GENIUS10

10-Amp Fully-Automatic Smart Charger, 6V and 12V Battery Charger, Battery Maintainer, Trickle Charger, and Battery Desulfator with Temperature Compensation

- Similar to our G70, just better - It's 17% smaller and delivers over 28% more power and it's simpler and easier to use than ever before - plug-in, connect to the battery, select a charge mode, & start charging your battery
- Enjoy precision charging - An integrated thermal sensor detects the ambient temperature and alters the charge to eliminate over-charging in hot climates and under-charging in cold climates.
- Charge dead batteries - Charges batteries as low as 1-volt. Or use the all-new force mode that allows you to take control and manually begin charging dead batteries down to zero volts.
- Beyond maintenance - It's not just a trickle charger, it's an advanced battery maintainer. A fully-automatic, worry-free battery charger for everyday use - 24/7 - with zero overcharge.
- Compatible with all types of vehicles - charge and maintain cars, motorcycles, lawn mowers, ATVs, lawn tractors, trucks, SUVs, boats, PWCs, classic cars, and more
- Specs: .399 pounds; 4.41 x 4.48 x 9.1 inches



MFG # PART #
GENIUS2X2 651108

GENIUS2X2

2-Bank, 4-Amp (2-Amp Per Bank) Fully-Automatic Smart Charger, 6V and 12V Battery Charger, Battery Maintainer, Trickle Charger, and Battery Desulfator with Temperature Compensation

- Multiple banks - A two-bank battery charger maintainer rated a 4-amps - 2-amps per bank - designed to charge and maintain multiple vehicles like cars, motorcycles, boats, ATVs, RVs, lawn mowers, lawn tractors, trucks, and more
- Enjoy precision charging - An integrated thermal sensor detects the ambient temperature and alters the charge to eliminate over-charging in hot climates and under-charging in cold climates
- Charge dead batteries - Charges batteries as low as 1-volt. Or use the all-new force mode that allows you to take control and manually begin charging dead batteries down to zero volts
- Specs: 4.59 pounds; 6.97 x 5.31 x 10.24 inches



MFG # PART #
GENIUS2X4 651109

GENIUS2X4

4-Bank, 8-Amp (2-Amp Per Bank) Fully-Automatic Smart Charger, 6V And 12V Battery Charger, Battery Maintainer, Trickle Charger, And Battery Desulfator With Temperature Compensation

- Multiple banks - A four-bank battery charger maintainer rated a 8-amps - 2-amps per bank - designed to charge and maintain multiple vehicles like cars, motorcycles, boats, ATVs, RVs, lawn mowers, lawn tractors, trucks, and more
- Enjoy precision charging - An integrated thermal sensor detects the ambient temperature and alters the charge to eliminate over-charging in hot climates and under-charging in cold climates
- Designed for water - A fully-sealed and waterproof onboard battery charger with an ingress protection rating of IP68, but has survived brutal life cycle testing, including thousands of hours underwater
- Specs: 7.78 pounds; 6.97 x 5.31 x 10.79 inches



MFG # PART #
GEN5X1 651110

GEN5X1

1-Bank, 5-Amp (5-Amp Per Bank) Fully-Automatic Smart Marine Charger, 12V Onboard Battery Charger, Battery Maintainer And Battery Desulfator With Temperature Compensation

- Multiple banks - A one-bank onboard battery charger rated a 5-amps - 5-amps per bank - for 12-volt batteries, including marine, boat, starter, and deep-cycle batteries.
- Charging modes - Independently charge and control each battery bank with selectable charging modes - including 12V, 12V AGM, 12V Lithium, and 12V Repair Mode - for all types of lead-acid and lithium-ion batteries.
- Enjoy precision charging - An integrated thermal sensor detects the ambient temperature and alters the charge to eliminate over-charging in hot climates and under-charging in cold climates.
- Designed for water - A fully-sealed and waterproof onboard battery charger with an ingress protection rating of IP68, but has survived brutal life cycle testing, including thousands of hours underwater
- Specs: 2.61 pounds; 7.22 x 5.16 x 5.16 inches



MFG # PART #
GEN5X2 651111

GEN5X2

2-Bank, 10-Amp (5-Amp Per Bank) Fully-Automatic Smart Marine Charger, 12V Onboard Battery Charger, Battery Maintainer And Battery Desulfator With Temperature Compensation

- Multiple banks - A two-bank onboard battery charger rated a 10-amps - 5-amps per bank - for 12-volt batteries, including marine, boat, starter, and deep-cycle batteries
- Charging modes - Independently charge and control each battery bank with selectable charging modes - including 12V, 12V AGM, 12V Lithium, and 12V Repair Mode - for all types of lead-acid and lithium-ion batteries
- Redefined mounting - A simplified mounting system allows for quick and easy installations in any direction - even up-side-down - with an integrated anti-vibration backing to isolate shock, vibration, and noise
- Designed for water - A fully-sealed and waterproof onboard battery charger with an ingress protection rating of IP68, but has survived brutal life cycle testing, including thousands of hours underwater
- Specs: 5.26 pounds; 9.15 x 7.2 x 5.39 inches



MFG # PART #
GEN5X3 651112

GEN5X3

3-Bank, 15-Amp (5-Amp Per Bank) Fully-Automatic Smart Marine Charger, 12V Onboard Battery Charger, Battery Maintainer And Battery Desulfator With Temperature Compensation

- Multiple banks - A three-bank onboard battery charger rated a 15-amps - 5-amps per bank - for 12-volt batteries, including marine, boat, starter, and deep-cycle batteries
- Charging modes - Independently charge and control each battery bank with selectable charging modes - including 12V, 12V AGM, 12V Lithium, and 12V Repair Mode - for all types of lead-acid and lithium-ion batteries
- Redefined mounting - A simplified mounting system allows for quick and easy installations in any direction - even up-side-down - with an integrated anti-vibration backing to isolate shock, vibration, and noise
- Designed for water - A fully-sealed and waterproof onboard battery charger with an ingress protection rating of IP68, but has survived brutal life cycle testing, including thousands of hours underwater
- Specs: 6.09 pounds; 10.08 x 8.86 x 5.62 inches



MFG # PART #
GENPRO10X1 651113

GENPRO10X1

1-Bank, 10-Amp (10-Amp Per Bank) Fully-Automatic Smart Marine Charger, 12V Onboard Battery Charger, Battery Maintainer And Battery Desulfator With Temperature Compensation

- Meet the all-new GENPRO10X1 - Similar to our GEN1, only better. It's 41% smaller and delivers 33% more power. It's one of the best performing onboard marine battery chargers we have ever made.
- Multiple banks - A one-bank onboard battery charger rated a 10-amps - 10-amps per bank - for 12-volt batteries, including marine, boat, starter, and deep-cycle batteries.
- Charging modes - Independently charge and control each battery bank with selectable charging modes - including 12V, 12V AGM, 12V Lithium, and 12V Repair Mode - for all types of lead-acid and lithium-ion batteries.
- Enjoy precision charging - An integrated thermal sensor detects the ambient temperature and alters the charge to eliminate over-charging in hot climates and under-charging in cold climates.
- Redefined mounting - A simplified mounting system allows for quick and easy installations in any direction - even up-side-down - with an integrated anti-vibration backing to isolate shock, vibration, and noise.
- Designed for water - A fully-sealed and waterproof onboard battery charger with an ingress protection rating of IP68, but has survived brutal life cycle testing, including thousands of hours underwater.
- Specs: 5.13 pounds; 7.62 x 7.2 x 6.1 inches



MFG # PART #
GENPRO10X2 651114

GENPRO10X2

2-Bank, 20-Amp (10-Amp Per Bank) Fully-Automatic Smart Marine Charger, 12V Onboard Battery Charger, Battery Maintainer And Battery Desulfator With Temperature Compensation

- Meet the all-new GENPRO10X2 - Similar to our GEN2, only better. It's 19% smaller and delivers 33% more power. It's one of the best performing onboard marine battery chargers we have ever made.
- Multiple banks - A two-bank onboard battery charger rated a 20-amps - 10-amps per bank - for 12-volt batteries, including marine, boat, starter, and deep-cycle batteries.
- Charging modes - Independently charge and control each battery bank with selectable charging modes - including 12V, 12V AGM, 12V Lithium, and 12V Repair Mode - for all types of lead-acid and lithium-ion batteries.
- Enjoy precision charging - An integrated thermal sensor detects the ambient temperature and alters the charge to eliminate over-charging in hot climates and under-charging in cold climates.
- Redefined mounting - A simplified mounting system allows for quick and easy installations in any direction - even up-side-down - with an integrated anti-vibration backing to isolate shock, vibration, and noise.
- Designed for water - A fully-sealed and waterproof onboard battery charger with an ingress protection rating of IP68, but has survived brutal life cycle testing, including thousands of hours underwater.
- Specs: 8.74 pounds; 10.28 x 9.25 x 6.06 inches



MFG # PART #
GENPRO10X3 651115

GENPRO10X3

3-Bank, 30-Amp (10-Amp Per Bank) Fully-Automatic Smart Marine Charger, 12V Onboard Battery Charger, Battery Maintainer And Battery Desulfator With Temperature Compensation

- Multiple banks - A three-bank onboard battery charger rated a 30-amps - 10-amps per bank - for 12-volt batteries, including marine, boat, starter, and deep-cycle batteries.
- Charging modes - Independently charge and control each battery bank with selectable charging modes - including 12V, 12V AGM, 12V Lithium, and 12V Repair Mode - for all types of lead-acid and lithium-ion batteries.
- Enjoy precision charging - An integrated thermal sensor detects the ambient temperature and alters the charge to eliminate over-charging in hot climates and under-charging in cold climates. Operating Temperature: -4° to 104° F (-20° to 50° C)
- Charge dead batteries - Charges batteries as low as 1-volt. Or use the all-new force mode that allows you to take control and manually begin charging dead batteries down to zero volts.
- Redefined mounting - A simplified mounting system allows for quick and easy installations in any direction - even up-side-down - with an integrated anti-vibration backing to isolate shock, vibration, and noise.
- Designed for water - A fully-sealed and waterproof onboard battery charger with an ingress protection rating of IP68, but has survived brutal life cycle testing, including thousands of hours underwater.
- Specs: 13.43 pounds; 12.9 x 10.67 x 6.06 inches



MFG # PART #
GENPRO10X4 651116

GENPRO10X4*

4-Bank, 40-Amp (10-Amp Per Bank) Fully-Automatic Smart Marine Charger, 12V Onboard Battery Charger, Battery Maintainer And Battery Desulfator With Temperature Compensation

- Multiple banks - A four-bank onboard battery charger rated a 40-amps - 10-amps per bank - for 12-volt batteries, including marine, boat, starter, and deep-cycle batteries.
- Charging modes - Independently charge and control each battery bank with selectable charging modes - including 12V, 12V AGM, 12V Lithium, and 12V Repair Mode - for all types of lead-acid and lithium-ion batteries.
- Enjoy precision charging - An integrated thermal sensor detects the ambient temperature and alters the charge to eliminate over-charging in hot climates and under-charging in cold climates.
- Charge dead batteries - Charges batteries as low as 1-volt. Or use the all-new force mode that allows you to take control and manually begin charging dead batteries down to zero volts.
- Redefined mounting - A simplified mounting system allows for quick and easy installations in any direction - even up-side-down - with an integrated anti-vibration backing to isolate shock, vibration, and noise.
- Designed for water - A fully-sealed and waterproof onboard battery charger with an ingress protection rating of IP68, but has survived brutal life cycle testing, including thousands of hours underwater..
- Specs: 16.98 pounds; 13.78 x 11.65 x 6.06 inches

**This item is not regularly stocked and requires a special order.*



MFG # PART #
GB20 650464

GENIUS BOOST SPORT GB20 400 AMP 12V ULTRASAFE LITHIUM JUMP STARTER

- Compact, yet powerful lithium jump starter rated at 400 Amps (4,650 Joules3S) - up to 20 jump starts on a single charge
- An ultra-safe & mistake-proof design with spark-proof technology & reverse polarity protection, which allow it to safely connect to any battery
- An ultra-bright 100 lumen LED flashlight with 7 light modes, including SOS and Emergency Strobe
- Recharge your personal devices on the go, like smartphones, tablets, e-watches and more - up to 4 smartphone recharges
- Designed for gas engines up to 4 Liters for motorcycles, ATVs, lawn mowers, cars & more
- (not recommended on diesel applications)



MFG # PART #
GB40 650465

GENIUS BOOST PLUS GB40 1000 AMP 12V ULTRASAFE LITHIUM JUMP STARTER

- Compact, yet powerful lithium jump starter rated at 1,000 Amps (7,000 Joules3S) - up to 20 jump starts on a single charge
- An ultra-safe and mistake-proof design with spark-proof technology and reverse polarity protection, which allow it to safely connect to any battery
- An ultra-bright 100 lumen LED flashlight with 7 light modes, including SOS & Emergency Strobe
- Recharge your personal devices on the go, like smartphones, tablets, e-watches & more - up to 4 smartphone recharges
- Designed for gas engines up to 6 liters & diesel engines up to 3 liters for cars, boats, lawn mowers & more



MFG # PART #
GB70 650466

GENIUS BOOST HD GB70 2000 AMP 12V ULTRASAFE LITHIUM JUMP STARTER

- Compact, powerful lithium jump starter rated at 2,000 Amps (15,700 Joules3S) with spark-proof technology & reverse polarity protection - up to 40 jump starts on a single charge
- Enjoy portable 12-volt power from anywhere for tire pumps, inverters, lights & more; plus rapid recharging in just over 3 hours
- An ultra-bright 400 lumen LED flashlight with 7 light modes, including SOS & Emergency Strobe
- Recharge your personal devices on the go, like smartphones, tablets, e-watches & more - up to 8 smartphone recharges
- Designed for gas engines up to 8 Liters & diesel engines up to 6 Liters for cars, boats, trucks, tractors & more



MFG #	PART #
GB50	651100

**GB50 BOOST XL 1,500 AMP
ULTRASAFE LITHIUM JUMP STARTER**

- UltraSafe, ultra-compact, rugged, & portable lithium-ion jump starter
- Features spark-proof technology and reverse polarity protection
- Instantly jump starts most single-battery applications, up to 30 times on a single charge
- Ideal for wide range of vehicles including small diesel cars, trucks & engines up to 7.0L Gas & 4.5L diesel
- It's internal battery can be used to recharge any personal mobile devices like smartphones, tablets, or any other USB device, and can be recharged by any powered USB port
- 4 XLED : The GB50 portable car battery jump starter integrates with a high-output 200 lumen LED flashlight with 7 light modes: low, medium, high, flashing, strobe, and emergency SOS



SPECIAL ORDER	
MFG #	PART #
GB500	651101

GENIUS BOOST GB500 MAX JUMP STARTER™

- For high-displacement gas and diesel engines in trucks, semis, buses, hgv, fleet, commercial vehicles, construction equipment and more
- Ultra-safe, compact, and portable lithium-ion jump starter for both 12V and 24V battery systems
- Features patented spark-proof technology and reverse polarity protection
- Built for gas & diesel engines in Class 8+/CE highdisplacement vehicles, equipment, trucks, & more
- Safe for engines of all sizes
- Provides remote power for 12V devices (e.g. tire pumps) & recharges mobile devices, like smartphones, tablets & more
- Jump starts 12V/24V Switchable 12V & 24V modes, designed for high-displacement engines, covering most applications
- Voltmeter : Built-in voltmeter displays the voltage of the vehicle's battery for enhanced diagnostics and troubleshooting
- High-Intensity LED Work Light: 2200 lumen ultra-bright LED work light for extreme visibility. 7 light modes, including SOS and emergency strobe

BATTERY CHARGER ACCESSORIES

WICKED SMART OPTIONS

Genius accessories are designed to expand the versatility of the NOCO Genius multi-purpose battery chargers. The accessories offer different ways to connect to batteries, extend the reach of the chargers, add connections to multiple vehicles, replace existing connectors and more.

BATTERY CLAMP CONNECTOR

Fits G750-G70



PART #
650213

The GC001 Battery Clamp Connector works with NOCO Genius battery chargers and allows the battery chargers to connect quickly to any battery. Replace a lost connector or add a set to a convenient location for easy charging. The Quick Connect cable makes connecting the Battery Clamp Connector simple.

EYELET TERMINAL CONNECTOR

Fits G750-G70



PART #
650214

The GC002 Eyelet Terminal Connector works with NOCO Genius battery chargers and allows the battery chargers to connect quickly to any battery. Replace a lost connector or permanently mount one on your ATV, Motorcycle, Car, Boat or any other vehicle for easy charging. The Quick Connect cable makes connecting the Eyelet Terminal Connector simple.

12V PLUG CONNECTOR

Fits G750-G3500



PART #
650215

The GC003 12V Plug Connector works with NOCO Genius battery chargers and allows the battery chargers to charge and maintain your vehicle's battery by simply plugging into the 12V auxiliary plug/cigarette lighter.

10' EXTENSION CABLE

Fits G750-G70



PART #
65016

Extend the reach of your NOCO Genius battery charger and accessories with the GC004 10' Extension Cable. With Quick Connect connectors on both ends, connecting the 10' Extension Cable is simple. Using this accessory may increase the battery charger time.



**BOOST MAX™
BATTERY CLAMPS**

**SPECIAL ORDER
ONLY**

**PART #
651104**



**BOOST MAX™
72" BATTERY CLAMPS**

**SPECIAL ORDER
ONLY**

**PART #
651105**



HD BATTERY CLAMP

**SPECIAL ORDER
ONLY**

**PART #
651102**

Exclusively designed & engineered for BOOST MAX™

- Boost MAX™ Battery Clamps feature a heavy-duty clamp designed for both 12-volt and 24-volt gas and diesel engines in Class 8+/CE high-displacement vehicles and equipment
- Heavy Duty Design: Our no-melt and smoke-free clamps are reinforced with all metal versus generic clamps all plastic construction
- Made from durable, high-performance 2AWG silicone wire that maintains its flexibility in cold weather environments
- The Boost Max™ camlock cable connectors will not slip or disconnect from the GB500 when the cables are pulled
- HD Battery Clamps feature a heavy-duty clamp design for automotive, marine, RV and truck applications
- Heavy Duty Design: Our no-melt and smoke-free clamps are reinforced with all metal versus generic clamps all plastic construction
- Made from durable, high performance 8AWG silicone wire that maintains its flexibility in cold weather environments
- Compatible Models : 650464, 650465, 651100



TYTANEUM BATTERIES

Tough. Reliable. Whether you ride daily, seasonally, or just on weekends, you'll get more enjoyment out of your motorcycle, ATV, PWC or snowmobile with a TYTANEUM battery. Our batteries perform reliably during off-road, over water and cold weather use, and keep their charge even after months of storage. Available in traditional flooded or the new sealed AGH designs, TYTANEUM batteries are built to withstand punishing vibration, salt spray, gas and oil, and protect against equipment-damaging spills, corrosion and seepage. And because nothing ruins a weekend faster than a dead battery, we use advanced designs and manufacturing techniques to shorten current paths and reduce resistance, giving you higher cranking power and maximum battery life.

MAINTENANCE FREE HIGH PERFORMANCE

SEALED MAINTENANCE FREE

Once these batteries are put into service, they become a completely sealed unit requiring a lot less maintenance than Conventional Batteries. Although the battery still needs to be charged on a regular basis if your vehicle is not in use, there is no need to monitor the fluid level in this battery type. Unlike the Conventional Battery, once this type battery is sealed, it becomes spill proof, which can eliminate damage from battery acid that can occur from using a flooded battery.

FACTORY ACTIVATED MAINTENANCE FREE

The same convenience and technology as the Sealed Maintenance Free Batteries mentioned above, except this battery is sealed and activated at the time of manufacture. Very convenient to the point that all that needs to be done is put the battery into your vehicle and you are ready to ride. The only downside of this type of battery is that all batteries once activated have a shelf life, and if this battery is not going to be used right away, or be put in a vehicle that is not going to be ridden on a regular basis, the battery will need to be kept charged on a battery maintainer.



BATTERY ACID FLUID

BOTTLE SIZE	PART #
570CC (22.1 OZ)	899099
850CC (32.99 OZ)	899100

HIGH PERFORMANCE TYPE BATTERY		
BATTERY TYPE	WITH ACID PACK	FACTORY ACTIVATED
YTX14AH	899017	899018
YTX14AHL	899019	899020
YTX24HL	899023	----
YTX14H	899101	899102
YTX20CH	899084	899107
YTX20H	899103	899104
YTX20HL	899085	899105
YTX20HL-PW	----	899106

~ IMPORTANT ~
 TYTANEUM High Performance Batteries are shipped with 1 acid pack. The battery must be filled and charged prior to first use.
 TYTANEUM High Performance Factory Activated Batteries have been filled with acid and charged at the factory. We recommend you charge these batteries prior to first use.

YTZ MAINTENANCE FREE

Factory sealed and activated YTZ Batteries are smaller and lighter and designed to provide maximum power in minimum space.



KTZ FACTORY ACTIVATED MAINTENANCE FREE

BATTERY TYPE	PART #
YTZ10S	899024
YTZ12S	899025
YTZ14S	899026
YTZ5S	899027
YTZ7S	899028



MAINTENANCE FREE

SEALED MAINTENANCE FREE

Once these batteries are put into service, they become a completely sealed unit requiring a lot less maintenance than Conventional Batteries. Although the battery still needs to be charged on a regular basis if your vehicle is not in use, there is no need to monitor the fluid level in this battery type. Unlike the Conventional Battery, once this type battery is sealed, it becomes spill proof, which can eliminate damage from battery acid that can occur from using a flooded battery.

FACTORY ACTIVATED MAINTENANCE FREE

The same convenience and technology as the Sealed Maintenance Free Batteries mentioned above, except this battery is sealed and activated at the time of manufacture. Very convenient to the point that all that needs to be done is put the battery into your vehicle and you are ready to ride. The only downside of this type of battery is that all batteries once activated have a shelf life, and if this battery is not going to be used right away, or be put in a vehicle that is not going to be ridden on a regular basis, the battery will need to be kept charged on a battery maintainer.



MAINTENANCE FREE BATTERY		
BATTERY TYPE	WITH ACID PACK	FACTORY ACTIVATED
YIX30L	899015	----
YT12A	899016	----
YTX12	899074	899075
YTX14	899076	899077
YTX14L	899078	899079
YTX15L	899080	----
YTX16	899081	----
YTX16-1	899082	----
YTX20	899108	899083
YTX20L	899086	899088
YTX4L	899089	899090
YTX5L	899091	899092
YTX7A	899093	899094
YTX7L	899095	899096
YTX9	899097	899098



BATTERY ACID FLUID

BOTTLE SIZE	PART #
570CC (22.1 OZ)	899099
850CC (32.99 OZ)	899100

~ IMPORTANT ~

TYTANEUM Maintenance Free Batteries are shipped with 1 acid pack. The battery must be filled and charged prior to first use.



TYTANEUM Maintenance Free Factory Activated Batteries have been filled with acid and charged at the factory. We recommend you charge these batteries prior to first use.



CONVENTIONAL

This type of batteries has flooded electrolyte and is very accessible. These batteries have to be carefully and periodically maintained. The conventional batteries are normally less expensive than the other types mentioned, but with the cost savings come more maintenance. You will need to add distilled water from time to time to prevent the battery from sulfating. Water loss is a normal characteristic of this type of battery because of the high temperature inside, and the process of electrolysis and evaporation. This means the fluid level of the battery needs to be checked on a regular basis. Conventional batteries also tend to discharge more rapidly than AGM type batteries.

CONVENTIONAL FLOODED BATTERY

BATTERY TYPE	WITH ACID PACK	BATTERY TYPE	WITH ACID PACK
SY50N18L-AT	899029	12N12A-4A-1	899001
SYB14L-A2	899030	12N14-3A	899002
Y50-N18A-A	899031	12N5.5-3B	899003
Y50-N18L-A3	899032	12N5.5-4A	899004
Y60N30L-A	899033	12N5.5A-3B	899005
YB10A-A2	899034	12N5-3B	899006
YB10L-A2	899035	12N5-4B	899007
YB10L-B2	899036	12N7-3B	899008
YB10L-B	899037	12N7-4A	899009
YB12A-A	899038	12N7-4B	899010
YB12A-B	899039	12N7D-3B	899011
YB12AL-A	899040	12N9-3A-1	899012
YB12AL-A2	899041	12N9-3B	899013
YB12B-B2	899042	12N9-4B-1	899014
YB12C-A	899043		
YB14-A2	899044		
YB14A-A2	899045		
YB14-B2	899047		
YB14L-A1	899048		
YB14L-A2	899049		
YB14L-B2	899050		
YB16AL-A2	899051		
YB16B-A1	899052		
YB16B-A	899053		
YB16-B	899054		
YB16CL-B	899055		
YB18-A	899057		
YB18L-A	899058		
YB2.5L-C-1	899060		
YB30L-B	899061		
YB3L-A	899062		
YB3L-B	899063		
YB4L-A	899064		
YB4L-B	899065		
YB5L-B	899066		
YB7-A	899067		
YB7C-A	899068		
YB7L-B	899069		
YB9A-A	899070		
YB9-B	899071		
YB9L-A2	899072		
YB9L-B	899073		



BATTERY ACID FLUID	
BOTTLE SIZE	PART #
570CC (22.1 OZ)	899099
850CC (32.99 OZ)	899100

~ IMPORTANT ~

TYTANEUM Conventional Batteries are shipped with 1 acid pack. The battery must be filled and charged prior to first use.

BATTERY



MAINTENANCE FREE HIGH PERFORMANCE BATTERIES

BATTERY TYPE	YUASA HIGH PERFORMANCE M/F	YUASA FACTORY ACTIVATED HIGH PERFORMANCE M/F	TYTANEUM HIGH PERFORMANCE M/F	TYTANEUM FACTORY ACTIVATED HIGH PERFORMANCE M/F
YTX14H-BS	920-101	920-134	----	----
YTX14AH-BS	920-102	920-131	899017	899018
YTX14AHL-BS	920-103	920-132	899019	899020
YTX20H-BS	920-104	920-137	----	----
YTX20HL-BS	920-105	920-138	899085	----
YTX20HL-BS-PW	920-106	920-140	----	----
YTX24HL-BS	920-107	920-139	899023	----
YTX20CH-BS	920-108	----	899084	----
**(PIX50L-BS)				

YUASA YTZ MAINTENANCE FREE, FACTORY ACTIVATED (12 VOLT) BATTERIES

BATTERY TYPE	YUASA YTZ M/F FACTORY ACTIVATED	TYTANEUM PTZ M/F, FACTORY ACTIVATED
GYZ20HL	920-241	----
YTZ5S	258006*	899027
YTZ7S	920-141	899028
YTZ10S	920-142	899024
YTZ12S	920-143	899025
YTZ14S	920-144	899026

* Not Factory activated

MAINTENANCE FREE BATTERIES

BATTERY TYPE	YUASA M/F	YUASA FACTORY ACTIVATED M/F	TYTANEUM M/F	TYTANEUM FACTORY ACTIVATED M/F
YTX4L-BS	920-110	----	899089	899090
YTX5L-BS	920-111	----	899091	899092
YT7B-BS	920-112	----	----	----
YTX7A-BS	920-113	----	899093	899094
YTX7L-BS	920-114	----	899095	899096
YTX9-BS	920-115	920-128	899097	899098
YT9B-BS	920-116	----	----	----
YT12A-BS	920-117	----	899016	----
YT12B-BS	920-118	----	----	----
YTX12-BS	920-119	920-129	899074	899075
YTX14-BS	920-120	920-130	899076	899077
YTX14L-BS	920-121	920-133	899078	899079
YT14B-BS	920-122	----	----	----
YTX15L-BS	----	----	899080	----
YTX16-BS	920-124	----	899081	----
YTX16-BS-1	920-125	----	899082	----
YTX20-BS	920-126	920-135	----	----
YTX20L-BS	920-127	920-136	899086	899083
YIX30L-BS	920-109	920-145	899015	899088



YUMICRON BATTERIES

BATTERY TYPE	YUASA YUMICRON 12 VOLT	YUASA YUMICRON CX-12 VOLT	TYTANEUM HIGH PERFORMANCE
YB2.5L-C-1	----	----	899060
YB3L-A	----	----	899062
YB3L-B	----	----	899063
YB4L-A	----	----	899064
YB4L-B	920-154	----	899065
YB5L-B	920-155	----	899066
YB7-A	920-156	----	899067
YB7B-B	920-157	----	----
YB7C-A	920-158	----	899068
YB7L-B	----	----	899069
YB9A-A	920-160	----	899070
YB9L-A2	----	----	899072
YB9-B	920-162	----	899071
YB9L-B	920-163	----	899073
YB10A-A2	920-164	----	899034
YB10L-A2	920-165	----	899035
YB10L-B	920-166	----	899037
YB10L-B2	920-167	----	899036
YB12A-A	920-168	----	899038
YB12AL-A	920-171	----	899040
YB12AL-A2	920-172	----	899041
YB12A-B	920-173	----	899039
YB12C-A	920-175	----	899043
YB14-A2	920-176	----	899044
YB14A-A1	920-177	----	----
YB14A-A2	920-178	----	899045
YB14L-A1	----	----	899048
	*Acid Not included	*Acid Not included	*Acid Packs included in all Tytaneum Batteries

YUMICRON BATTERIES

BATTERY TYPE	YUASA YUMICRON 12 VOLT	YUASA YUMICRON CX-12 VOLT	TYTANEUM HIGH PERFORMANCE
YB14L-A2	920-180	----	899049
YB14L-A2 w/sensor	----	----	899030
YB14L-B2	920-182	----	899050
YB14-B2	920-183	----	899047
SYB14L-A2	----	----	899030
YB16AL-A2	920-185	----	899051
HYB16A-AB	----	----	----
YB16-B	----	----	899054
YB16L-B	----	----	899056
YB16B-A	----	----	899053
YB16B-A1	920-190	----	899052
YB16C-B	920-191	----	----
YB16CL-B	920-192	----	899055
YB18-A	----	----	899057
YB18L-A	----	----	899058
Y50-N18A-A	920-195	----	899031
Y50-N18L-A	920-196	----	----
Y50-N18L-A3	----	----	899032
Y50-N18L-A3-CX	----	----	----
SY50-N18L-AT	920-198	----	899029
YB30L-B	920-203	----	899061
YB30CL-B	920-204	----	----
51814	920-205	----	----
51913	920-206	----	----
53030	920-207	----	----
	*Acid Not included	*Acid Not included	*Acid Packs included in all Tytaneum Batteries

CONVENTIONAL 12 VOLT BATTERIES

BATTERY TYPE	YUASA	TYTANEUM
12N5-3B	920-208	899006
12N5.5-3B	920-210	899003
12N5.5-4A	----	899004
12N5.5A-3B	----	899005
12N7-3B	----	899008
12N7-4A	920-214	899009
12N7-4B	----	899010
12N7D-3B	920-216	899011
12N9-3A	----	----
12N9-3B	----	899013
12N9-4B-1	920-219	899014
12N12A-4A-1	920-222	899001
12N14-3A	920-223	899002
12N24-3	920-225	----
YHD-12H	----	----
YIX30L	----	899109



FACTORY ACTIVATED MAINTENANCE FREE	HIGH PERFORMANCE MAINTENANCE FREE	MAINTENANCE FREE VRLA	YUMICRON CX	YUMICRON	CONVENTIONAL
-	-	-	-	6YB11-2D	6N11-2D
-	YTX4L-BS	YT4L-BS (DISCONTINUED)	-	YB4L-A, YB4L-B	-
YTZ7S	YTX5L-BS	YT5L-BS (DISCONTINUED)	-	-	-
-	-	-	-	YB5L-B	12N5-3B
-	-	-	-	YB7L-B	12N7-3B
-	-	-	-	YB7-A	12N7-4A
-	-	-	-	YB9-B	12N9-4B-1
-	-	-	-	YB9L-B	12N9-3B
-	-	-	-	YB10L-A2	12N10-3A-2
-	-	-	-	YB12A-A	12N12A-4A-1
YTX14H	YTX14H-BS	YTX14-BS	-	-	-
YTX14AH	YTX14AH-BS	-	-	YB14-A2, YB14-B2	-
YTX14AH ##	YTX14AH-BS ##	-	-	YB14A-A1, YB14A-A2	-
YTX14AHL	YTX14AHL-BS	-	-	YB14L-A2	12N14-3A
YTX14AHL	YTX14AHL-BS	-	-	YB14L-B2	-
-	YTX20CH-BS	YTX16-BS	-	-	-
YTX20H, YTX20 †	YTX20H-BS †	YTX20-BS †	YB16-B-CX	YB16-B	-
YTX20H, YTX20 †	YTX20H-BS †	YTX20-BS †	-	YB18-A	-
YTX20HL-PW S	YTXH20L-BS-PW S	-	-	YB16CL-B	-
YTX20HL, YTX20L C	YTX20HL-BS C	YTX20L-BS C	YB16HL-A-CX	-	-
YTX20HL, YTX20L †	YTX20HL-BS †	YTX20L-BS †	-	YB16L-B	-
YTX20HL, YTX20L †	YTX20HL-BS †	YTX20L-BS †	-	YB18L-A	-
GYZ20L	YTX20HL-BS †	YTX20L-BS	-	-	-
YTX24HL #	YTX24HL-BS #	-	Y50-N18L-A-CX	Y50-N18L-A	-
YTX24HL	YTX24HL-BS	-	-	Y50-N18L-A3	-
YTX24HL # (1)	YTX24HL-BS # (1)	-	-	SY50-N18L-AT	-
YIX30L	-	-	-	YB30L-B	-
YIX30L	-	-	-	53030	Y60-N24L-B (disc.)

VRLA Valve Regulated Lead Acid.

Includes 10mm spacer for use in replacing YB14A-A1 and YB14A-A2.

S Includes 20mm spacer for use in replacing YB16CL-B.

C Requires use of Yuasa Cover/Spacer Kit part no. 478651

† The YTX20 series batteries may be used as an optional upgrade, but some modification to the hold down may be necessary.

See label for retrofit cautions.

Top and front terminal mounts only.

(1) Eliminates need for sensor (needs to be disabled).



DESIGNATION OF BATTERY TYPE NUMBERS



- 1 Nominal voltage
- 2 Conventional battery
- 3 Size of battery case
- 4 Polarity location
- 5 Exhaust location
- 6 Designates unique terminal

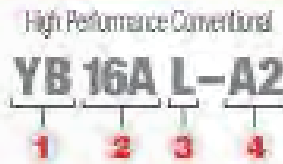

- 1 High Performance Conventional battery
- 2 Size of battery case
- 3 Polarity location
- 4 Terminal and Exhaust location



- 1 High Performance AGM (YTX, YB, YTZ, YT, GYZ)
- 2 Performance classification
- 3 Designates unique battery case size
- 4 Higher CCA
- 5 Polarity location
- 6 Bottle supplied electrolyte
- 7 Designates unique terminal

MAINTENANCE FREE HIGH PERFORMANCE

If high power is top priority in a replacement battery, look to Yuasa's High Performance Maintenance Free batteries. Yuasa means more power, less maintenance and longer life. Yuasa's High Performance Maintenance Free batteries are your best choice for motorcycles, utility vehicles, scooters, ATVs, riding mowers, personal watercraft and snowmobiles.

ALL OF THE FEATURES OF A STANDARD MAINTENANCE FREE PLUS

Increased Power – Up to 30% more cranking amps thanks to a radial grid design and additional plates.

Selected types also available in Factory Activated (filled, sealed and charged at the factory).



BATTERY TYPE	YUASA HIGH PERFORMANCE	YUASA FACTORY ACTIVATED HIGH PERFORMANCE
YTX14H-BS	920-101	920-134
YTX14AH-BS	920-102	920-131
YTX14AHL-BS	920-103	920-132
YTX20H-BS	920-104	920-137
YTX20HL-BS	920-105	920-138
YTX20HL-BS-PW	920-106	920-140
YTX24HL-BS	920-107	920-139
YTX20CH-BS	920-108	----
YIX30L-BS	920-109	920-145
YIX30L-BS-PW	258012	----
YIX30L-PW	258059	----

~ IMPORTANT ~

Yuasa High Performance Batteries are shipped with 1 acid pack. The battery must be filled and charged prior to first use.



Yuasa High Performance Factory Activated Batteries have been filled with acid and charged at the factory. We recommend you charge these batteries prior to first use.

YTZ MAINTENANCE FREE

High-performance, compact, and lightweight, Yuasa YTZ batteries deliver maximum power from minimal space. Featuring exclusive expanded plate technology, they offer up to 80% more starting power per kg. Factory sealed, spill-proof, and maintenance-free, they support multi-angle fitment and extended lifespan with reduced self-discharge and superior vibration resistance

- Up to 80% more starting power per Kg
- Maximum power – minimum space
- Reduced self discharge for longer life
- Superior vibration resistance

BATTERY TYPE	YUASA YTZ M/F FACTORY ACTIVATED
GYZ20HL	920-241
YTZ7S	920-141
YTZ10S	920-142
YTZ12S	920-143
YTZ14S	920-144
YTZ5S-BS	258006
YTZ8V	258030
YTZV4	258065
YTZ6V	258066



~ IMPORTANT ~
Yuasa YTZ Maintenance Free Batteries have been filled with acid and charged at the factory. We recommend you charge these batteries prior to first use.

GYZ MAINTENANCE FREE

THE GYZ SERIES – NEXT GENERATION POWERSPORTS BATTERY

- AGM (Absorbed Glass Mat) separators with superior grid and component designs
- Improved charge recovery capability from a deeply discharged condition
- Longer shelf life
- Improved life cycle performance
- Extreme vibration resistance
- Supplied "Factory Activated" (non-spillable)
- Heavy duty, flush mounted terminals. Patent pending embedded brass nut
- Upgrade for customized motorcycles requiring the best performance

BATTERY TYPE	REPLACES STANDARD BATTERY	ADDITIONAL AMP HOURS	ADDITIONAL CCA	YUASA GYZ FACTORY ACTIVATED
GYZ16HL	YTX14L	4	40	258004
GYZ16H	YTX14H	4	40	258011
GYZ20HL	YTX20L	2	-	920-241
GYZ20HL-C	YTX20LC	2	-	258064
GYZ20H	YTX20H	2	-	258009
GYZ20HA	YTX20HA	2	-	258058
GYZ20L	YTX20L	2	-	258010
GYZ32HL	YIX30L	2	115	258005



~ IMPORTANT ~
Yuasa YTZ Maintenance Free Batteries have been filled with acid and charged at the factory. We recommend you charge these batteries prior to first use.

MAINTENANCE FREE

Absorbed Glass Mat (AGM) Technology is an advanced battery design used in Yuasa's Maintenance Free Batteries that eliminates water loss. Once it's filled with acid the battery is permanently sealed - so you'll never need to fill it with water or check the acid level.

Long Life

Because of its lead calcium design, the AGM battery will hold its specific gravity more than three times longer than conventional lead antimony types. This means much longer periods between charges when the battery is used in a standby mode, like winter storage. And to remain factory-fresh the AGM battery is shipped dry along with its own pack of high-gravity acid that's added at the time of installation.

Sealed, Non-spillable

Once filled with acid from its special packs, the AGM battery is virtually maintenance free. It's totally sealed and all of the acid is absorbed in the special plates and separators, so there is no need to worry about acid leaks on valuable vehicle parts and accessories.

Selected types also available in Factory Activated (filled, sealed and charged at the factory).



BATTERY TYPE	YUASA MAINTENANCE FREE	YUASA FACTORY ACTIVATED M/F
YTX4L-BS	920-110	----
YTX5L-BS	920-111	----
YT7B-BS	920-112	----
YTX7A-BS	920-113	----
YTX7L-BS	920-114	----
YTX9-BS	920-115	920-128
YT9B-BS	920-116	----
YT12A-BS	920-117	----
YT12B-BS	920-118	920-129
YTX12-BS	920-119	----
YTX14-BS	920-120	920-130
YTX14L-BS	920-121	920-133
YT14B-BS	920-122	----
YTX16-BS	920-124	----
YTX16-BS-1	920-125	----
YTX20-BS	920-126	920-135
YTX20L-BS	920-127	920-136
YT19BL-BS	258007	----
YTX20CH	----	258031
YT4B-BS	920-242	----

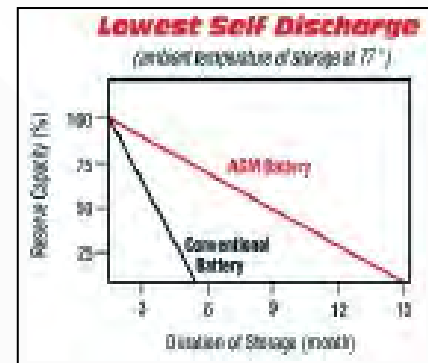

~ IMPORTANT ~

Yuasa Maintenance Free Batteries are shipped with 1 acid pack. The battery must be filled and charged prior to first use.

~~~~~

Yuasa Maintenance Free Factory Activated Batteries have been filled with acid and charged at the factory. We recommend you charge these batteries prior to first use.

## YUMICRON

The Yuasa YuMicron gives you a powerful advantage. It's high technology separators allow two extra plates per cell to be installed, for a 30% improvement in cranking performance

### The Power Advantage

This added power is an outstanding benefit for heavily accessorized machines or high compression engines. It's high cranking power is also a real bonus for easier starting.



| BATTERY TYPE | YUASA YUMICRON |
|--------------|----------------|
| YB10L-B2     | 920-167        |
| YB12A-A      | 920-168        |
| YB12AL-A     | 920-171        |
| YB12AL-A2    | 920-172        |
| YB12A-B      | 920-173        |
| YB12C-A      | 920-175        |
| YB14-A2      | 920-176        |
| YB14A-A1     | 920-177        |
| YB14A-A2     | 920-178        |
| YB14L-A2     | 920-180        |
| YB14L-B2     | 920-182        |
| YB14-B2      | 920-183        |
| YB16AL-A2    | 920-185        |
| YB16B-A1     | 920-190        |
| YB16C-B      | 920-191        |
| YB16CL-B     | 920-192        |
| Y50-N18A-A   | 920-195        |
| Y50-N18L-A   | 920-196        |
| SY50-N18L-AT | 920-198        |
| YB30L-B      | 920-203        |
| YB30CL-B     | 920-204        |
| 51913        | 920-206        |
| 53030        | 920-207        |
| YB16HL-A-CX  | 920-147        |
| YB12B-B2     | 920-174        |

| BATTERY TYPE | YUASA YUMICRON |
|--------------|----------------|
| YB4L-B       | 920-154        |
| YB5L-B       | 920-155        |
| YB7-A        | 920-156        |
| YB7B-B       | 920-157        |
| YB7C-A       | 920-158        |
| YB9A-A       | 920-160        |
| YB9-B        | 920-162        |
| YB9L-B       | 920-163        |
| YB10A-A2     | 920-164        |
| YB10L-A2     | 920-165        |
| YB10L-B      | 920-166        |

## BATTERY ACID FLUID



- Battery acid used in Yumicron and Conventional type batteries
- NOT to be used in Maintenance Free type batteries

| BATTERY ACID FLUID         |        |
|----------------------------|--------|
| BOTTLE SIZE                | PART # |
| 570CC (22.1 OZ)            | 899099 |
| 850CC (32.99 OZ)           | 899100 |
| Acid Bottles Boxed (32 OZ) | 258074 |

## CONVENTIONAL

A workhorse battery engineered to protect against corrosion, withstand vibration and deliver high cranking power.

The industry standard for motorcycles and riding mowers, our Conventional Battery is anything but conventional. This workhorse is for applications requiring operation on uneven surfaces and vibrating environments - even when the weather's dealing its worst. It's the rugged, reliable and dependable battery that customers are looking for!

These features are built into our conventional manifold vented battery - and every battery in the YUASA line:

- Patented separators provide high cranking power
- Through-partition construction delivers maximum power
- Unique sealed posts resist corrosion for longer battery life
- Polypropylene cover and container thwart damage from gas, oil, and impact
- Heat-sealed, bonded unit fabrication protects against seepage and corrosion

| BATTERY TYPE | YUASA CONVENTIONAL | BATTERY TYPE | YUASA CONVENTIONAL |
|--------------|--------------------|--------------|--------------------|
| 12N5-3B      | <b>920-208</b>     | 6N4B-2A      | <b>258036</b>      |
| 12N5-4B      | <b>920-209</b>     | 6N2-2A-4     | <b>258037</b>      |
| 12N5.5-3B    | <b>920-210</b>     | 6N6-3B       | <b>258038</b>      |
| 12N7-4A      | <b>920-214</b>     | 6N2A-2C-3    | <b>258039</b>      |
| 12N7D-3B     | <b>920-216</b>     | 6N4-2A-5     | <b>258040</b>      |
| 12N9-4B-1    | <b>920-219</b>     | 6N4C-1B      | <b>258041</b>      |
| 12N12A-4A-1  | <b>920-222</b>     | 6N2-2A       | <b>258042</b>      |
| 12N14-3A     | <b>920-223</b>     | 6N4-2A       | <b>258043</b>      |
| 12N24-3      | <b>920-225</b>     | 6N6-1D-2     | <b>258044</b>      |
| 6N5.5-1D     | <b>258032</b>      | 6N2A-2C      | <b>258045</b>      |
| 6N4-2A-8     | <b>258033</b>      | 6N6-3B-1     | <b>258046</b>      |
| 6N4-2A-4     | <b>258034</b>      | 6N11A-1B     | <b>258047</b>      |
| 6N11-2D      | <b>258035</b>      | 6N12A-2D     | <b>258048</b>      |



**~ IMPORTANT ~**

Yuasa Yumicron/Yumicron CX Batteries are shipped dry with no acid. To order acid for your battery first check the acid volume needed on the Battery Specification Chart then order part #899099 for a 22.1 oz. bottle and part #899100 for a 33.99 oz. bottle.



## YUASA BATTERY CROSS REFERENCE CHART

| YUASA                                           | EXIDE    | DEKA   | DELCO    | INTERSTATE   | GS-ZTONG YEE | GS-JSB      | MOTO CROSS | NAPA     | SEARS | WAL-MART | YACHT      |
|-------------------------------------------------|----------|--------|----------|--------------|--------------|-------------|------------|----------|-------|----------|------------|
| <b>FACTORY SEALED / SEALED MAINTENANCE FREE</b> |          |        |          |              |              |             |            |          |       |          |            |
| YTR4A-BS                                        | -        | -      | -        | CYTR4A-BS    | GTR4A-5      | -           | M62R4A     | -        | -     | -        | -          |
| YT4B-BS                                         | -        | -      | -        | CYT4B-BS     | GT4B-5       | -           | M62T4B     | -        | -     | -        | -          |
| YTX4L-BS                                        | 4L-BS    | -      | GT4L-BS  | CYTX4L-BS    | GT4L-BS      | -           | M62X4B     | 740-1865 | 44015 | ES4LBS   | CT4L-BS    |
| YTX5L-BS                                        | 5L-BS    | -      | GTX5L-BS | CYTX5L-BS    | GTX5L-BS     | -           | M32X5B     | -        | 44022 | -        | -          |
| YTX7A-BS                                        | 7A-BS    | -      | -        | CYTX7A-BS    | GTX-7A-BS    | -           | M32X7A     | -        | 44023 | -        | CTX7A-BS   |
| YT7B-BS                                         | -        | -      | -        | CYT7B-BS     | GT7B-4       | -           | M62T7B     | -        | -     | -        | -          |
| YTX7L-BS                                        | 7L-BS    | -      | -        | CYTX7L-BS    | -            | GTX7L-BS    | M327BS     | -        | 44024 | -        | CTX7L-BS   |
| YTZ7S                                           | -        | -      | -        | FAYTZ7S      | GT6B-3       | -           | M727ZS     | -        | -     | -        | -          |
| YTX9-BS                                         | 9-BS     | ETX9   | GTX9-BS  | CYTX9-BS     | GTX9-BS      | -           | M329BS     | 740-1825 | 44025 | -        | CTX9-BS    |
| YT9B-BS                                         | -        | -      | -        | CYT9B-BS     | GT9B-4       | -           | M629B4     | -        | -     | -        | -          |
| YTZ10S                                          | -        | -      | -        | FAYTZ10S     | -            | -           | M7210A     | -        | -     | -        | -          |
| YTX12-BS                                        | 12-BS    | ETX12  | GTX12-BS | CYTX12-BS    | GTX12-BS     | -           | M3RH2S     | 740-1866 | 44016 | ES12BS   | CTX12-BS   |
| YT12B-BS                                        | -        | -      | -        | CYT12B-BS    | GT12B-4      | -           | M6212B     | -        | -     | -        | -          |
| YTZ12S                                          | -        | -      | -        | FAYTZ12S     | -            | -           | M7212A     | -        | -     | -        | -          |
| YTX14-BS                                        | 14-BS    | ETX14  | GTX14-BS | CYTX14-BS    | GTX14-BS     | -           | M3RH4S     | 740-1886 | 44017 | ES14BS   | CTX14-BS   |
| YTX14AH-BS                                      | -        | ETX15  | -        | CYTX14AH-BS  | -            | -           | M62H4A     | -        | 44004 | -        | -          |
| YTX14AHL-BS                                     | -        | ETX15L | -        | CYTX14AHL-BS | -            | -           | M62H4L     | -        | 44005 | -        | -          |
| YT14B-BS                                        | -        | -      | -        | CYT14B-BS    | GT14B-4      | -           | M624B4     | -        | -     | -        | -          |
| YTX14L-BS                                       | -        | -      | -        | CYTX14L-BS   | -            | -           | -          | -        | -     | -        | -          |
| YTZ14S                                          | -        | -      | -        | FAYTZ14S     | -            | -           | M72Z14     | -        | -     | -        | CTX20L-BS  |
| YTX15L-BS                                       | -        | -      | -        | CYTX15L-BS   | -            | -           | M6215L     | -        | 44162 | -        | -          |
| YTX16-BS                                        | -        | -      | -        | CYTX16-BS    | -            | -           | M32X6S     | -        | -     | -        | -          |
| YTX20-BS                                        | 16-BS    | ETX16  | TBA      | CYTX20-BS    | GT16-BS      | -           | M32RBS     | TBA      | 44028 | -        | -          |
| YTXCH-BS                                        | -        | -      | -        | CYTX20CH-BS  | -            | -           | M62C       | -        | -     | -        | -          |
| YTX20L-BS                                       | 16L-BS   | ETX16L | TBA      | CYTX20L-BS   | GT16L-BS     | -           | M320BS     | TBA      | 44027 | -        | -          |
| YTX20L-BS                                       | 20L-BS   | ETXL   | TBA      | CYTX20L-BS   | GTX20L-BS    | -           | M320BS     | TBA      | 44027 | -        | CTX20L-BS  |
| YTX24HL-BS                                      | 18L-BS   | ETX18L | TBA      | CYTX24HL-BS  | GTX18L-BS    | -           | M6250H     | TBA      | 44006 | -        | -          |
| YIX30L-BS                                       | -        | -      | -        | FAYIX30L     | -            | YGIX30      | M7230L     | -        | -     | -        | -          |
| <b>YUMICRON HIGH PERFORMANCE CONVENTIONAL</b>   |          |        |          |              |              |             |            |          |       |          |            |
| YB2.5L-C                                        | 2.5L-C   | -      | -        | YB2.5L-C     | CB2.5L-C     | GM2.5A-3C-3 | M325LC     | -        | 44035 | -        | CB2.5L-C   |
| YB2.5L-C-1                                      | 2.5L-C-1 | -      | -        | YB2.5L-C-1   | CB2.5L-C-1   | GM2.5A-3C-1 | M32LC1     | -        | 44036 | -        | CB2.5L-C-1 |
| YB3L-A                                          | 3L-A     | -      | -        | YB3L-A       | CB3L-A       | GM3-3A      | M323LA     | -        | 44037 | -        | CB3L-A     |
| YB3L-B                                          | 3L-B     | -      | -        | YB3L-B       | CB3L-B       | GM3-3B      | M223LB     | -        | 44038 | -        | CB3L-B     |
| YB4L-A                                          | 4L-A     | -      | -        | YB4L-A       | CB4L-A       | GM4A-3B     | M224LA     | -        | 44039 | -        | CB4L-A     |
| YB4L-B                                          | 4L-B     | -      | MC0414   | YB4L-B       | CB4L-B       | GM4-3B      | M324LB     | 740-1861 | 44014 | -        | CB4L-B     |
| YB5L-B                                          | 5L-B     | -      | -        | YB5L-B       | CB5L-B       | GM5Z-3B     | M325LB     | 740-1868 | 44353 | -        | CB5L-B     |
| YB7-A                                           | 7-A      | -      | -        | YB7-A        | CB7-A        | GM7Z-4A     | M227AY     | -        | 44040 | -        | CB7-A      |
| YB7C-A                                          | 7C-A     | -      | -        | YB7C-A       | -            | GM7CZ-3D    | M227CY     | M227CY   | 44041 | -        | CB7C-A     |
| YB7L-B                                          | 7L-B     | -      | -        | YB7L-B       | CB7L-B       | GM7-3B-1    | M2273Y     | -        | 44042 | -        | CB7L-B     |
| YB9A-A                                          | 9AA      | -      | CB9A-A   | YB9A-A       | CB9A-A       | GM9AZ-4A    | M329AY     | 740-1872 | 44043 | -        | CB9A-A     |
| YB9L-A2                                         | 9L-A2    | -      | -        | YB9L-A2      | CB9L-A2      | -           | M2292Y     | -        | 44044 | -        | CB9L-A2    |
| YB9-B                                           | 9-B      | -      | -        | YB9-B        | CB9-B        | GM9Z-4B     | M329BY     | 740-1858 | 44356 | -        | CB9-B      |



## YUASA BATTERY CROSS REFERENCE CHART CONTINUED

| YUASA                                         | EXIDE       | DEKA | DELCO     | INTERSTATE  | GS-ZTONG YEE | GS-JSB      | MOTO CROSS | NAPA     | SEARS | WAL-MART     | YACHT        |
|-----------------------------------------------|-------------|------|-----------|-------------|--------------|-------------|------------|----------|-------|--------------|--------------|
| <b>YUMICRON HIGH PERFORMANCE CONVENTIONAL</b> |             |      |           |             |              |             |            |          |       |              |              |
| YB9L-B                                        | 9LB         | -    | -         | YB9L-B      | CB9L-B       | GM9Z-3B     | M329LY     | 740-1837 | 44045 | -            | CB9L-B       |
| YB10A-A2                                      | 10A-A       | -    | -         | YB10A-A2    | CB10A-A      | -           | M321AY     | -        | 44046 | -            | CB10A-A      |
| YB10L-A2                                      | 10LA2       | -    | MC1114    | YB10L-A2    | CB10L-A2     | GM10Z-3A    | M3210Y     | 740-1857 | 44355 | ES10LA2      | CB10L-A2     |
| YB10L-B                                       | 10L-B       | -    | -         | YB10L-B     | CB10L-B      | GM10-3B     | M321LB     | 740-1831 | 44047 | -            | CB10L-B      |
| YB10L-B2                                      | 10L-B2      | -    | -         | YB10L-B2    | CB10L-B2     | -           | M221L2     | 740-1832 | 44048 | -            | -            |
| YB12A-A                                       | 12AA        | -    | MC1216    | YB12A-A     | CB12A-A      | GM12AZ-4A-1 | M3212Y     | 740-1854 | 44358 | ES12AA       | CB12A-A      |
| YB12AL-A                                      | 12AL-A      | -    | -         | YB12AL-A    | CB12AL-A     | GM12AZ-3A-1 | M3221Y     | 740-1873 | 44052 | -            | CB12AL-A     |
| YB12A-B                                       | 12A-B       | -    | -         | YB12A-B     | -            | -           | M222AB     | -        | 44053 | -            | CB12A-B      |
| YB12B-B2                                      | 12B-B2      | -    | -         | YB12B-B2    | CB12B-B2     | GM12B-4B    | M221B2     | -        | 44054 | -            | CB12B-B2     |
| YB12C-A                                       | 12C-A       | -    | -         | YB12C-A     | -            | GM12CZ-4A-2 | M222CA     | -        | 44055 | -            | CB12C-A      |
| YB14-A2                                       | 14-A2       | -    | -         | YB14-A2     | CB14-A2      | GM14Z-4A    | M3214H     | 740-1864 | 44363 | -            | CB14-A2      |
| YB14A-A1                                      | 14AA1       | -    | -         | YB14A-A1    | CB14A-A      | GM14AZ-4A   | M224A1     | 740-1826 | 44056 | -            | CB14A-A1     |
| YB14A-A2                                      | 14AA2       | -    | MC1418    | YB14A-A2    | CB14A-A2     | GM14AZ-4A-1 | M3214A     | 740-1860 | -     | ES14AA2      | CB14A-A2     |
| YB14L-A1                                      | 14L-A1      | -    | -         | YB14L-A1    | CB14L-A1     | GM14Z-3A-1  | M22141     | -        | 44057 | -            | CB14L-A1     |
| YMF14L-2*                                     | 14L-2       | -    | -         | -           | -            | -           | -          | -        | -     | -            | -            |
| YB14L-A2                                      | 14L-A2      | -    | MC1406    | YB14L-A2    | CB14L-A2     | GM14Z-3A    | M3214Y     | 740-1851 | 44364 | ES14L-A2     | CB14L-A2     |
| YB14L-B2                                      | 14L-B2      | -    | -         | YB14L-B2    | CB14L-B2     | GM14Z-3B    | M2214B     | 740-1828 | 44059 | -            | CB14L-B2     |
| YB14-B2                                       | 14-B2       | -    | -         | YB14-B2     | CB14-B2      | -           | M224B2     | -        | 44060 | -            | CB14-B2      |
| SYB14L-A2                                     | 14LA2       | -    | -         | SYB14L-A2   | SCB14-LA2    | -           | M2214S     | -        | 44061 | -            | SCB14-LA2    |
| SYB14L-B2                                     | 14-LB2      | -    | -         | SYB14L-B2   | SCB14-LB2    | -           | M22B4S     | -        | 44062 | -            | SCB14-LB2    |
| YB16AL-A2                                     | 16ALA2      | -    | CB16AL-A2 | YB16AL-A2   | CB16AL-A2    | GM16A-3A    | M32162     | 740-1877 | 44063 | -            | CB16AL-A2    |
| HYB16A-AB                                     | 16AA        | -    | -         | HYB16A-AB   | HCB16A-A     | GM16-T      | M32H6B     | 740-1867 | 44064 | -            | HCB16A-A     |
| YB16-B                                        | 16B         | -    | MC1912    | YB16-B      | CB16-B       | GM16Z-4BH   | M3216Y     | 740-1852 | 44366 | ES16B        | CB16-B       |
| YB16L-B                                       | 16LB        | -    | -         | YB16L-B     | CB16L-B      | GM16Z-3B    | M3216K     | 740-1827 | 44065 | -            | CB16L-B      |
| YB16-B-CX                                     | 16-B-LM     | -    | -         | YB16-B-LM   | GT16-BS      | -           | M3216C     | -        | 44029 | -            | CB16-B-LM    |
| YB16HL-A-CX                                   | 16HL-A-LM   | -    | -         | YB16HL-A-LM | GT16L-BS     | -           | M2H16C     | -        | -     | -            | CB16HL-A-LM  |
| YB16B-A                                       | 16B-A       | -    | -         | YB16B-A     | -            | GM16B-4A    | M2216B     | -        | 44066 | -            | CB16B-A      |
| YB16B-A1                                      | 16B-A1      | -    | -         | YB16B-A1    | -            | -           | M22161     | -        | 44067 | -            | CB16B-A1     |
| YB16C-B                                       | 16C-B       | -    | -         | YB16C-B     | -            | -           | M326CB     | -        | 44068 | -            | -            |
| YB16CL-B                                      | 16CLB       | -    | M1924     | YB16CL-B    | CB16CL-B     | GM16AZ-3B   | M3S6CL     | 740-1862 | 44001 | ES16CLB      | CB16CL-B     |
| SYB16L-B                                      | 16L-B       | -    | -         | SYB16L-B    | SCB16L-B     | -           | M22S6A     | -        | 44069 | -            | SCB16L-B     |
| YB18-A                                        | 18-A        | -    | -         | YB18-A      | CB18-A       | GM18A-4A    | M321Y      | 740-1874 | 44070 | -            | CB18-A       |
| YB18L-A                                       | 18LA        | -    | -         | YB18L-A     | CB18L-A      | GM18A-3A    | M3218L     | 740-1871 | 44071 | -            | CB18L-A      |
| Y50-N18A-A                                    | 50-N18A-A   | -    | -         | Y50-N18A-A  | -            | -           | M228AY     | -        | 44072 | -            | C50-N18A-A   |
| Y50-N18L-A                                    | 50N18LA2    | -    | MC08      | Y50-N18L-A  | C50-N18L-A3  | GM18Z-3A(S) | M3218Y     | -        | -     | ES50N-N18L-A | SCB50-N18L-A |
| Y50-N18L-A3                                   | 50N18LA3 ** | -    | -         | Y50-N18L-A3 | C50-N18L-A3  | -           | M328A3     | 740-1855 | 44359 | -            | C50-N18L-A3  |
| Y60-N24-A                                     | 60-N24-A    | -    | -         | Y60-N24-A   | C60-N24L-A   | -           | M2224A     | -        | 44074 | -            | C60-N24-A    |
| Y60-N24AL-B                                   | 60-N24AL-B  | -    | -         | Y60-N24AL-B | -            | -           | M2224B     | 740-1880 | 44075 | -            | C60-N24AL-B  |

\* Superseded by YTX14AHL-BS

\*\* GNB's 50N18LA2 replaces 50N18LA3

## BATTERY SPECIFICATIONS

| HIGH PERFORMANCE, MAINTENANCE FREE BATTERY SPECIFICATIONS - 12 VOLT |    |                        |                                      |        |        |                               |    |     |                           |                  |                        |                                  |                              |
|---------------------------------------------------------------------|----|------------------------|--------------------------------------|--------|--------|-------------------------------|----|-----|---------------------------|------------------|------------------------|----------------------------------|------------------------------|
| BATTERY TYPE                                                        |    | CAPACITY<br>AH (10H-R) | DIMENSIONS - INCHES<br>(+/- 1/16 IN) |        |        | DIMENSIONS - MM<br>(+/- 2 MM) |    |     | WEIGHT<br>W/O<br>ACID LBS | TERMINAL<br>TYPE | ACID<br>VOL.<br>LITERS | REGULAR<br>CHARGE<br>CURRENT AMP | C.C.A. @<br>0° F<br>(-18° C) |
|                                                                     |    |                        | L                                    | W      | H      | L                             | W  | H   |                           |                  |                        |                                  |                              |
| YTX14AH-BS ##                                                       | FA | 12                     | 5 5/16                               | 3 1/2  | 6 9/16 | 134                           | 89 | 166 | 9.0                       | 4                | 0.66                   | 1.2                              | 210                          |
| YTX14AHL-BS                                                         | FA | 12                     | 5 5/16                               | 3 1/2  | 6 9/16 | 134                           | 89 | 166 | 9.0                       | 4                | 0.66                   | 1.2                              | 210                          |
| YTX14H-BS                                                           | FA | 12                     | 6                                    | 3 7/16 | 5 3/4  | 150                           | 87 | 145 | 8.6                       | 4                | 0.69                   | 1.2                              | 260                          |
| YTX20CH-BS                                                          |    | 18                     | 6                                    | 3 7/16 | 6 3/8  | 150                           | 87 | 161 | 11.0                      | 4                | 0.82                   | 1.8                              | 270                          |
| YTX20H-BS                                                           | FA | 18                     | 6 7/8                                | 3 7/16 | 6 1/8  | 175                           | 87 | 155 | 12.4                      | 4                | 0.93                   | 1.8                              | 310                          |
| YTX20HL-BS                                                          | FA | 18                     | 6 7/8                                | 3 7/16 | 6 1/8  | 175                           | 87 | 155 | 12.4                      | 4                | 0.93                   | 1.8                              | 310                          |
| YTX20HL-BS-PW                                                       | FA | 18                     | 6 7/8                                | 3 7/16 | 6 7/8  | 175                           | 87 | 175 | 12.4                      | 4                | 0.93                   | 1.8                              | 310                          |
| YTX24HL-BS                                                          | FA | 21                     | 8 1/8                                | 3 7/16 | 6 3/8  | 5                             | 87 | 162 | 14.4                      | 4                | 0.99                   | 2.1                              | 350                          |

| FACTORY ACTIVATED MAINTENANCE FREE BATTERY SPECIFICATIONS - 12 VOLT |    |                        |                                      |         |         |                               |     |      |                           |                  |                        |                                  |                              |
|---------------------------------------------------------------------|----|------------------------|--------------------------------------|---------|---------|-------------------------------|-----|------|---------------------------|------------------|------------------------|----------------------------------|------------------------------|
| BATTERY TYPE                                                        |    | CAPACITY<br>AH (10H-R) | DIMENSIONS - INCHES<br>(+/- 1/16 IN) |         |         | DIMENSIONS - MM<br>(+/- 2 MM) |     |      | WEIGHT<br>W/O<br>ACID LBS | TERMINAL<br>TYPE | ACID<br>VOL.<br>LITERS | REGULAR<br>CHARGE<br>CURRENT AMP | C.C.A. @<br>0° F<br>(-18° C) |
|                                                                     |    |                        | L                                    | W       | H       | L                             | W   | H    |                           |                  |                        |                                  |                              |
| YTZ7S                                                               |    | 6                      | 4 7/16                               | 2 3/4   | 4 1/8   | 113                           | 70  | 105  | 4.6                       | 5                | N/A                    | 0.6                              | 130                          |
| YTZ10S                                                              |    | 8.6                    | 6                                    | 3 7/16  | 3 11/16 | 150                           | 87  | 93   | 7.0                       | 11               | N/A                    | 0.9                              | 190                          |
| YTZ12S                                                              |    | 11                     | 6                                    | 3 7/16  | 4 3/8   | 150                           | 87  | 110  | 8.1                       | 11               | N/A                    | 1.1                              | 210                          |
| YTZ14S                                                              |    | 11.2                   | 6                                    | 3 7/16  | 4 3/8   | 150                           | 87  | 110  | 8.6                       | 11               | N/A                    | 1.1                              | 230                          |
| GYZ20L                                                              |    | 18                     | 6 7/8                                | 3 7/16  | 6 1/8   | 175                           | 87  | 155  | 15.2                      | 4                | N/A                    | 1.8                              | 270                          |
| YIX30L                                                              | FA | 30                     | 6 1/4                                | 5       | 7 1/2   | 166                           | 126 | 175  | 22.0                      | 5                | N/A                    | 3.0                              | 385                          |
| TR4A-BS                                                             |    | 2.3                    | 4 1/2                                | 1 15/16 | 3 3/8   | 114                           | 49  | 86   | 2.0                       | 12               | 0.14                   | 0.3                              | 45                           |
| YT4B-BS                                                             |    | 2.3                    | 4 1/2                                | 1 9/16  | 3 7/16  | 114                           | 39  | 86.5 | 2.1                       | 13               | 0.12                   | 0.3                              | 40                           |
| YTX4L-BS                                                            |    | 3                      | 4 1/2                                | 2 13/16 | 3 3/8   | 114                           | 71  | 86   | 2.9                       | 5                | 0.18                   | 0.4                              | 50                           |
| YTX5L-BS                                                            |    | 4                      | 4 1/2                                | 2 13/16 | 4 3/16  | 114                           | 71  | 106  | 3.5                       | 5                | 0.24                   | 0.5                              | 70                           |
| YT7B-BS                                                             |    | 6.5                    | 6                                    | 2 9/16  | 3 11/16 | 150                           | 65  | 93   | 5.0                       | 11               | 0.33                   | 0.7                              | 85                           |
| YTX7A-BS                                                            |    | 6                      | 6                                    | 3 7/16  | 3 3/4   | 150                           | 87  | 94   | 5.3                       | 5                | 0.33                   | 0.7                              | 90                           |
| YTX7L-BS                                                            |    | 6                      | 4 1/2                                | 2 13/16 | 5 3/16  | 114                           | 71  | 131  | 5.1                       | 5                | 0.33                   | 0.6                              | 85                           |
| YT9B-BS                                                             |    | 8                      | 6                                    | 2 3/4   | 4 1/8   | 150                           | 70  | 105  | 7.5                       | 11               | 0.4                    | 0.8                              | 115                          |
| YTX9-BS                                                             | FA | 8                      | 6                                    | 3 7/16  | 4 3/16  | 150                           | 87  | 105  | 5.4                       | 5                | 0.40                   | 0.9                              | 120                          |
| YT12A-BS                                                            |    | 9.5                    | 6                                    | 3 7/16  | 4 3/16  | 150                           | 87  | 105  | 6.3                       | 5                | 0.47                   | 1.0                              | 175                          |
| YT12B-BS                                                            |    | 10                     | 6                                    | 2 3/4   | 5 1/8   | 150                           | 69  | 130  | 7.6                       | 11               | 0.52                   | 1.0                              | 125                          |
| YTX12-BS                                                            | FA | 10                     | 6                                    | 3 7/16  | 5 1/8   | 150                           | 87  | 130  | 7.5                       | 5                | 0.60                   | 1.2                              | 180                          |
| KMX14-BS K                                                          |    | 12                     | 6                                    | 3 7/16  | 5 3/4   | 150                           | 87  | 145  | 8.1                       | 5                | 0.69                   | 1.4                              | 200                          |
| YT14B-BS                                                            |    | 12                     | 6 1/8                                | 2 3/4   | 5 3/4   | 152                           | 70  | 145  | 10.1                      | 11               | 0.60                   | 1.2                              | 210                          |
| YTX14-BS                                                            | FA | 12                     | 6                                    | 3 7/16  | 5 3/4   | 150                           | 87  | 145  | 8.1                       | 5                | 0.69                   | 1.4                              | 0                            |
| YTX14L-BS                                                           | FA | 12                     | 6                                    | 3 7/16  | 5 3/4   | 150                           | 87  | 145  | 8.1                       | 5                | 0.69                   | 1.4                              | 0                            |
| YTX15L-BS                                                           |    | 13                     | 6 7/8                                | 3 7/16  | 5 1/8   | 175                           | 87  | 130  | 8.8                       | 4                | 0.69                   | 1.3                              | 230                          |
| YTX16-BS                                                            |    | 14                     | 6                                    | 3 7/16  | 6 3/8   | 150                           | 87  | 161  | 10.3                      | 4                | 0.78                   | 1.4                              | 230                          |
| YTX16-BS-1                                                          |    | 14                     | 6                                    | 3 7/16  | 6 3/8   | 150                           | 87  | 161  | 10.3                      | 1                | 0.78                   | 1.4                              | 230                          |
| YTX20-BS                                                            | FA | 18                     | 6 7/8                                | 3 7/16  | 6 1/8   | 175                           | 87  | 155  | 11.2                      | 4                | 0.93                   | 1.8                              | 270                          |
| YTX20L-BS                                                           | FA | 18                     | 6 7/8                                | 3 7/16  | 6 1/8   | 175                           | 87  | 155  | 11.2                      | 4                | 0.93                   | 1.8                              | 270                          |

| YUMICRON CX BATTERY SPECIFICATIONS - 12 VOLT |  |                        |                                      |        |       |                               |     |     |                           |                  |           |                                     |                              |
|----------------------------------------------|--|------------------------|--------------------------------------|--------|-------|-------------------------------|-----|-----|---------------------------|------------------|-----------|-------------------------------------|------------------------------|
| BATTERY TYPE                                 |  | CAPACITY<br>AH (10H-R) | DIMENSIONS - INCHES<br>(+/- 1/16 IN) |        |       | DIMENSIONS - MM<br>(+/- 2 MM) |     |     | WEIGHT<br>W/O<br>ACID LBS | TERMINAL<br>TYPE | ACID VOL. | REGULAR<br>CHARGE<br>CURRENT<br>AMP | C.C.A. @<br>0° F<br>(-18° C) |
|                                              |  |                        | L                                    | W      | H     | L                             | W   | H   |                           |                  |           |                                     |                              |
| YB16-B-CX                                    |  | 19                     | 6 7/8                                | 4      | 6 1/8 | 175                           | 100 | 155 | 10.5                      | 6                | 40.6      | 1.9                                 | -                            |
| YB16HL-A-CX                                  |  | 19                     | 6 7/8                                | 4      | 6 1/8 | 175                           | 100 | 155 | 10.5                      | 6                | 40.6      | 1.9                                 | -                            |
| Y50-N18L-A-CX                                |  | 20                     | 8 1/8                                | 3 9/16 | 6 3/8 | 5                             | 90  | 162 | 11.2                      | 7                | 47.3      | 2.0                                 | -                            |

## BATTERY SPECIFICATIONS CONTINUED

| YUMICRON BATTERY SPECIFICATIONS -12 VOLT |                     |                                   |         |         |                            |      |     |                     |               |                  |                            |                        |
|------------------------------------------|---------------------|-----------------------------------|---------|---------|----------------------------|------|-----|---------------------|---------------|------------------|----------------------------|------------------------|
| BATTERY TYPE                             | CAPACITY AH (10H-R) | DIMENSIONS - INCHES (+/- 1/16 IN) |         |         | DIMENSIONS - MM (+/- 2 MM) |      |     | WEIGHT W/O ACID LBS | TERMINAL TYPE | ACID VOL. OUNCES | REGULAR CHARGE CURRENT AMP | C.C.A. @ 0° F (-18° C) |
|                                          |                     | L                                 | W       | H       | L                          | W    | H   |                     |               |                  |                            |                        |
| YB2.5L-C                                 | 2.5                 | 3 3/16                            | 2 3/4   | 4 1/8   | 80                         | 70   | 105 | 1.7                 | -             | 8.1              | 0.3                        | -                      |
| YB2.5L-C-1                               | 2.5                 | 3 3/16                            | 2 3/4   | 4 1/8   | 80                         | 70   | 105 | 1.7                 | -             | 8.1              | 0.3                        | -                      |
| YB3L-A                                   | 3                   | 3 7/8                             | 2 1/4   | 4 3/8   | 98                         | 56   | 110 | 2.5                 | 6             | 8.1              | 0.3                        | -                      |
| YB3L-B                                   | 3                   | 3 7/8                             | 2 1/4   | 4 3/8   | 98                         | 56   | 110 | 2.5                 | 6             | 8.1              | 0.3                        | -                      |
| YB4L-A                                   | 4                   | 4 3/4                             | 2 3/4   | 3 5/8   | 120                        | 70   | 92  | 2.8                 | 5             | 10.1             | 0.4                        | -                      |
| YB4L-B                                   | 4                   | 4 3/4                             | 2 3/4   | 3 5/8   | 120                        | 70   | 92  | 2.8                 | 5             | 10.1             | 0.4                        | -                      |
| YB5L-B                                   | 5                   | 4 3/4                             | 2 3/8   | 5 1/8   | 120                        | 60   | 130 | 3.5                 | 6             | 12.2             | 0.5                        | -                      |
| YB7-A                                    | 8                   | 5 5/16                            | 3       | 5 1/4   | 135                        | 75   | 133 | 5.1                 | 6             | 20.3             | 0.8                        | -                      |
| YB7B-B                                   | 7                   | 6                                 | 2 3/8   | 5 1/8   | 150                        | 60   | 130 | 4.0                 | 6             | 16.9             | 0.7                        | -                      |
| YB7C-A                                   | 8                   | 5 1/8                             | 3 9/16  | 4 1/2   | 130                        | 90   | 114 | 5.1                 | 3             | 20.3             | 0.8                        | -                      |
| YB7L-B                                   | 8                   | 5 5/16                            | 3       | 5 1/4   | 135                        | 75   | 133 | 5.1                 | 6             | 20.3             | 0.8                        | -                      |
| YB9A-A                                   | 9                   | 5 5/16                            | 3       | 6 1/8   | 135                        | 75   | 155 | 5.3                 | 6             | 20.3             | 0.9                        | -                      |
| YB9L-A2                                  | 9                   | 5 5/16                            | 3       | 5 1/2   | 135                        | 75   | 139 | 5.3                 | 2             | 20.3             | 0.9                        | -                      |
| YB9-B                                    | 9                   | 5 5/16                            | 3       | 5 1/2   | 135                        | 75   | 139 | 5.3                 | 6             | 20.3             | 0.9                        | -                      |
| YB9L-B                                   | 9                   | 5 5/16                            | 3       | 5 1/2   | 135                        | 75   | 139 | 5.3                 | 6             | 20.3             | 0.9                        | -                      |
| YB10A-A2                                 | 11                  | 5 5/16                            | 3 9/16  | 6 1/8   | 135                        | 90   | 155 | 7.0                 | 8             | 27.0             | 1.1                        | -                      |
| YB10L-A2                                 | 11                  | 5 5/16                            | 3 9/16  | 5 3/4   | 135                        | 90   | 145 | 7.0                 | 8             | 27.0             | 1.1                        | -                      |
| YB10L-B                                  | 11                  | 5 5/16                            | 3 9/16  | 5 3/4   | 135                        | 90   | 145 | 7.0                 | 6             | 27.0             | 1.1                        | -                      |
| YB10L-B2                                 | 11                  | 5 5/16                            | 3 9/16  | 5 3/4   | 135                        | 90   | 145 | 7.0                 | 8             | 27.0             | 1.1                        | -                      |
| YB12A-A                                  | 12                  | 5 5/16                            | 3 3/16  | 6 5/16  | 134                        | 80   | 160 | 6.8                 | 6             | 27.0             | 1.2                        | -                      |
| YB12A-A W/S †                            | 12                  | 5 5/16                            | 3 3/16  | 6 5/16  | 134                        | 80   | 160 | 6.8                 | 6             | 27.0             | 1.2                        | -                      |
| YB12A-A W/TA **                          | 12                  | 5 5/16                            | 3 3/16  | 6 5/16  | 134                        | 80   | 160 | 6.8                 | 6             | 27.0             | 1.2                        | -                      |
| YB12AL-A W/TA D1                         | 12                  | 5 5/16                            | 3 3/16  | 6 5/16  | 134                        | 80   | 160 | 6.8                 | 6             | 25.4             | 1.2                        | -                      |
| YB12AL-A                                 | 12                  | 5 5/16                            | 3 3/16  | 6 5/16  | 134                        | 80   | 160 | 6.8                 | 6             | 25.4             | 1.2                        | -                      |
| YB12AL-A2 *                              | 12                  | 5 5/16                            | 3 3/16  | 6 5/16  | 134                        | 80   | 160 | 6.8                 | 8             | 25.4             | 1.2                        | -                      |
| YB12A-B                                  | 12                  | 5 5/16                            | 3 3/16  | 6 5/16  | 134                        | 80   | 160 | 6.8                 | 6             | 25.4             | 1.2                        | -                      |
| YB12B-B2                                 | 12                  | 6 5/16                            | 3 9/16  | 5 1/8   | 160                        | 90   | 130 | 7.1                 | 8             | 27.0             | 1.2                        | -                      |
| YB12C-A                                  | 12                  | 5 5/16                            | 3 3/16  | 6 7/8   | 134                        | 80   | 175 | 7.1                 | 4             | 27.0             | 1.2                        | -                      |
| YB14-A2                                  | 14                  | 5 5/16                            | 3 1/2   | 6 9/16  | 134                        | 89   | 166 | 7.6                 | 8             | 30.4             | 1.4                        | -                      |
| YB14A-A1                                 | 14                  | 5 5/16                            | 3 1/2   | 6 15/16 | 134                        | 89   | 176 | 7.9                 | 6             | 30.4             | 1.4                        | -                      |
| YB14A-A2                                 | 14                  | 5 5/16                            | 3 1/2   | 6 15/16 | 134                        | 89   | 176 | 7.9                 | 8             | 30.4             | 1.4                        | -                      |
| YB14L-A1                                 | 14                  | 5 5/16                            | 3 1/2   | 6 9/16  | 134                        | 89   | 166 | 7.6                 | 1             | 30.4             | 1.4                        | -                      |
| YB14L-A2                                 | 14                  | 5 5/16                            | 3 1/2   | 6 9/16  | 134                        | 89   | 166 | 7.6                 | 8             | 30.4             | 1.4                        | -                      |
| YB14L-A2 W/S †                           | 14                  | 5 5/16                            | 3 1/2   | 6 9/16  | 134                        | 89   | 166 | 7.6                 | 8             | 30.4             | 1.4                        | -                      |
| YB14L-B2                                 | 14                  | 5 5/16                            | 3 1/2   | 6 9/16  | 134                        | 89   | 166 | 7.6                 | 8             | 30.4             | 1.4                        | -                      |
| YB14-B2                                  | 14                  | 5 5/16                            | 3 1/2   | 6 9/16  | 134                        | 89   | 166 | 7.6                 | 8             | 30.4             | 1.4                        | -                      |
| SYB14L-A2 #                              | 14                  | 5 5/16                            | 3 1/2   | 6 9/16  | 134                        | 89   | 166 | 7.6                 | 8             | 30.4             | 1.4                        | -                      |
| SYB14L-B2 #                              | 14                  | 5 5/16                            | 3 1/2   | 6 9/16  | 134                        | 89   | 166 | 7.6                 | 8             | 30.4             | 1.4                        | -                      |
| YB16AL-A2                                | 16                  | 8 1/8                             | 2 13/16 | 6 7/16  | 7                          | 71.5 | 164 | 8.6                 | 2             | 37.2             | 1.6                        | -                      |
| HYB16A-AB                                | 16                  | 6                                 | 3 5/8   | 7 1/16  | 151                        | 91   | 180 | 8.5                 | 7             | 30.4             | 1.6                        | -                      |
| YB16-B                                   | 19                  | 6 7/8                             | 4       | 6 1/8   | 175                        | 100  | 155 | 10.5                | 6             | 40.6             | 1.9                        | -                      |
| YB16L-B                                  | 19                  | 6 7/8                             | 4       | 6 1/8   | 175                        | 100  | 155 | 10.5                | 6             | 40.6             | 1.9                        | -                      |
| YB16B-A                                  | 16                  | 6 5/16                            | 3 9/16  | 6 3/8   | 160                        | 90   | 161 | 8.4                 | 4             | 33.8             | 1.6                        | -                      |
| YB16B-A1 *                               | 16                  | 6 5/16                            | 3 9/16  | 6 3/8   | 160                        | 90   | 161 | 8.4                 | 7             | 33.8             | 1.6                        | -                      |
| YB16C-B                                  | 19                  | 6 7/8                             | 4       | 6 7/8   | 175                        | 100  | 175 | 10.1                | 5             | 40.6             | 1.9                        | -                      |
| YB16CL-B                                 | 19                  | 6 7/8                             | 4       | 6 7/8   | 175                        | 100  | 175 | 10.1                | 5             | 40.6             | 1.9                        | -                      |
| SYB16L-B # D2                            | 19                  | 6 15/16                           | 4       | 6 1/8   | 175                        | 100  | 155 | 9.3                 | 6             | 43.9             | 1.9                        | -                      |
| YB18-A                                   | 18                  | 7 1/8                             | 3 9/16  | 6 3/8   | 180                        | 90   | 162 | 9.4                 | 7             | 40.6             | 1.8                        | -                      |
| YB18L-A                                  | 18                  | 7 1/8                             | 3 9/16  | 6 3/8   | 180                        | 90   | 162 | 9.4                 | 7             | 40.6             | 1.8                        | -                      |
| Y50-N18A-A                               | 20                  | 8 1/8                             | 3 9/16  | 6 15/16 | 5                          | 90   | 176 | 11.2                | 7             | 50.7             | 2.0                        | -                      |
| Y50-N18L-A                               | 20                  | 8 1/8                             | 3 9/16  | 6 3/8   | 5                          | 90   | 162 | 11.2                | 7             | 47.3             | 2.0                        | -                      |
| Y50-N18L-A3                              | 20                  | 8 1/8                             | 3 9/16  | 6 3/8   | 5                          | 90   | 162 | 11.2                | 4             | 47.3             | 2.0                        | -                      |
| YS50-N18L-AT #                           | 20                  | 8 1/8                             | 3 9/16  | 6 3/8   | 5                          | 90   | 162 | 11.2                | 7             | 47.3             | 2.0                        | -                      |

## BATTERY SPECIFICATIONS CONTINUED

| YUMICRON BATTERY SPECIFICATIONS - 12 VOLT |                     |                                   |        |         |                            |     |     |                     |               |                  |                            |                        |  |
|-------------------------------------------|---------------------|-----------------------------------|--------|---------|----------------------------|-----|-----|---------------------|---------------|------------------|----------------------------|------------------------|--|
| BATTERY TYPE                              | CAPACITY AH (10H-R) | DIMENSIONS - INCHES (+/- 1/16 IN) |        |         | DIMENSIONS - MM (+/- 2 MM) |     |     | WEIGHT W/O ACID LBS | TERMINAL TYPE | ACID VOL. OUNCES | REGULAR CHARGE CURRENT AMP | C.C.A. @ 0° F (-18° C) |  |
|                                           |                     | L                                 | W      | H       | L                          | W   | H   |                     |               |                  |                            |                        |  |
| Y60-N24-A                                 | 28                  | 7 1/4                             | 4 7/8  | 6 7/8   | 184                        | 124 | 175 | 14.4                | 3             | 57.5             | 2.8                        | -                      |  |
| Y60-N24AL-B D3                            | 28                  | 7 1/4                             | 4 7/8  | 6 7/8   | 184                        | 124 | 175 | 14.4                | 3             | 57.5             | 2.8                        | -                      |  |
| YB30L-B                                   | 30                  | 6 5/8                             | 5 3/16 | 6 15/16 | 168                        | 132 | 176 | 14.1                | 4             | 57.5             | 3.0                        | -                      |  |
| YB30CL-B                                  | 30                  | 6 5/8                             | 5 3/16 | 7 9/16  | 168                        | 132 | 192 | 14.5                | 4             | 57.5             | 3.0                        | -                      |  |
| 51814                                     | *** 19              | 7 7/16                            | 3 1/4  | 6 7/8   | 186                        | 82  | 171 | 9.4                 | 10            | 33.8             | 1.9                        | -                      |  |
| 51913                                     | *** 19              | 7 7/16                            | 3 1/4  | 6 7/8   | 186                        | 82  | 171 | 9.4                 | 10            | 33.8             | 1.9                        | -                      |  |
| 53030                                     | *** 30              | 7 7/16                            | 5 1/8  | 6 7/8   | 186                        | 130 | 171 | 16.1                | 10            | 54.1             | 3.0                        | -                      |  |

| CONVENTIONAL BATTERY SPECIFICATIONS - 12 VOLT |                     |                                   |        |         |                            |     |     |                     |               |                  |                            |                        |  |
|-----------------------------------------------|---------------------|-----------------------------------|--------|---------|----------------------------|-----|-----|---------------------|---------------|------------------|----------------------------|------------------------|--|
| BATTERY TYPE                                  | CAPACITY AH (10H-R) | DIMENSIONS - INCHES (+/- 1/16 IN) |        |         | DIMENSIONS - MM (+/- 2 MM) |     |     | WEIGHT W/O ACID LBS | TERMINAL TYPE | ACID VOL. OUNCES | REGULAR CHARGE CURRENT AMP | C.C.A. @ 0° F (-18° C) |  |
|                                               |                     | L                                 | W      | H       | L                          | W   | H   |                     |               |                  |                            |                        |  |
| 12N5-3B                                       | 5                   | 4 3/4                             | 2 3/8  | 5 1/8   | 1                          | 60  | 130 | 3.1                 | 6             | 13.5             | 0.5                        | -                      |  |
| 12N5-4B                                       | 5                   | 4 3/4                             | 2 3/8  | 5 1/8   | 1                          | 60  | 130 | 3.1                 | 6             | 13.5             | 0.5                        | -                      |  |
| 12N5.5-3B                                     | 5.5                 | 5 5/16                            | 2 3/8  | 5 1/8   | 135                        | 60  | 130 | 4.3                 | 6             | 13.5             | 0.6                        | -                      |  |
| 12N5.5-4A                                     | 5.5                 | 5 5/16                            | 2 3/8  | 5 1/8   | 135                        | 60  | 130 | 4.3                 | 2             | 13.5             | 0.6                        | -                      |  |
| 12N5.5A-3B                                    | 5.5                 | 4 1/16                            | 3 9/16 | 4 1/2   | 103                        | 90  | 114 | 4.3                 | 6             | 16.9             | 0.6                        | -                      |  |
| 12N7-3B                                       | 7                   | 5 5/16                            | 3      | 5 1/4   | 135                        | 75  | 133 | 4.9                 | 6             | 16.9             | 0.7                        | -                      |  |
| 12N7-4A                                       | 7                   | 5 5/16                            | 3      | 5 1/4   | 135                        | 75  | 133 | 4.9                 | 6             | 16.9             | 0.7                        | -                      |  |
| 12N7-4B                                       | 7                   | 5 5/16                            | 3      | 5 1/4   | 135                        | 75  | 133 | 4.9                 | 6             | 16.9             | 0.7                        | -                      |  |
| 12N7D-3B                                      | 7                   | 5 5/16                            | 3      | 5 15/16 | 135                        | 75  | 150 | 4.9                 | 6             | 20.3             | 0.7                        | -                      |  |
| 12N9-3A                                       | 9                   | 5 5/16                            | 3      | 5 1/2   | 135                        | 75  | 139 | 5.4                 | 9             | 20.3             | 0.9                        | -                      |  |
| 12N9-3A-1 D4                                  | 9                   | 5 5/16                            | 3      | 5 1/2   | 135                        | 75  | 139 | 5.4                 | 6             | 20.3             | 0.9                        | -                      |  |
| 12N9-3B                                       | 9                   | 5 5/16                            | 3      | 5 1/2   | 135                        | 75  | 139 | 5.4                 | 6             | 20.3             | 0.9                        | -                      |  |
| 12N9-4B-1                                     | 9                   | 5 5/16                            | 3      | 5 1/2   | 135                        | 75  | 139 | 5.4                 | 6             | 20.3             | 0.9                        | -                      |  |
| 12N10-3A D5                                   | 10                  | 5 5/16                            | 3 9/16 | 5 3/4   | 135                        | 90  | 145 | 6.4                 | 6             | 27.0             | 1.0                        | -                      |  |
| 12N10-3A-1 D5                                 | 10                  | 5 5/16                            | 3 9/16 | 5 3/4   | 135                        | 90  | 145 | 6.4                 | 6             | 27.0             | 1.0                        | -                      |  |
| 12N10-3A-2                                    | 10                  | 5 5/16                            | 3 9/16 | 5 3/4   | 135                        | 90  | 145 | 5.8                 | 8             | 27.0             | 1.0                        | -                      |  |
| 12N11-3A-1                                    | 11                  | 5 5/16                            | 3 9/16 | 6 1/8   | 135                        | 90  | 155 | 7.5                 | 8             | 27.0             | 1.1                        | -                      |  |
| 12N12A-4A-1                                   | 12                  | 5 5/16                            | 3 3/16 | 6 5/16  | 134                        | 80  | 160 | 6.8                 | 6             | 23.7             | 1.2                        | -                      |  |
| 12N14-3A                                      | 14                  | 5 5/16                            | 3 1/2  | 6 9/16  | 134                        | 89  | 166 | 7.5                 | 8             | 27.0             | 1.4                        | -                      |  |
| 12N24-3A                                      | 24                  | 7 1/4                             | 4 7/8  | 6 7/8   | 184                        | 124 | 175 | 12.1                | 3             | 40.6             | 2.4                        | -                      |  |
| 12N24-3                                       | 24                  | 7 1/4                             | 4 7/8  | 6 7/8   | 184                        | 124 | 175 | 12.1                | 3             | 40.6             | 2.4                        | -                      |  |
| YHD-12H                                       | 29                  | 8 1/8                             | 5 1/4  | 6 1/2   | 6                          | 133 | 165 | 13.3                | 9             | 74.4             | 2.8                        | -                      |  |

FA ALSO AVAILABLE FACTORY ACTIVATED. DROP "-BS" FROM PART NO.  
 ‡‡‡ INCLUDES 10MM SPACER FOR ADDITIONAL HEIGHT REQUIRED IN REPLACING YB14A-A1 AND YB14A-A2.  
 S HEIGHT WITH 20MM SPACER INCLUDED FOR USE IN REPLACING YB16CL-B.  
 K AVAILABLE AT KAWASAKI DEALERS ONLY.  
 † WHEN ORDERING THIS BATTERY, SPECIFY SENSOR.  
 # THIS BATTERY INCLUDES A SENSOR.  
 \* INCLUDES TERMINAL ADAPTOR FOR CONVERTING TO TOP MOUNT.  
 \*\* WHEN ORDERING THIS BATTERY, SPECIFY TERMINAL ADAPTOR.  
 \*\*\* @ 20 HR. RATE.  
 \*\*\*\* TEST RESULTS NOT AVAILABLE AT DATE OF PRINTING - VALUE IS THEORETICAL.

TIRES & TRACKS  
TUBES  
CHEMICALS  
TOOLS  
BATTERIES  
FUEL & INTAKE  
AIR & OIL FILTERS

## MB-2040 BATTERY CHARGER

- High Output charging current (4 amps)
- High Voltage capable (20 volts) – designed to improve recovery of sulfated batteries
- Switchable Mode operation
- Commercial Grade – perfect for Dealer / Shop use
- Suitable for all battery types – Conventional, as well as MF (AGM), including YTZ
- “Fast Mode” – for quick vehicle set-up
- “Normal Mode” – ideal for smaller batteries, initial activation, and deeply discharged batteries
- Automatic Shut-Off
- Reverse Polarity Protection / Spark-free Operation (UL / CUL approved)
- Durable construction for longer life
- 3 year limited warranty



| DESCRIPTION     | PART #  |
|-----------------|---------|
| Battery Charger | 920-227 |

## BATTERY CHARGER/MAINTAINER

Yuasa's Automatic 1A 12V battery charger is the industry's most powerful plug-in wall charger. Combining the latest technology and a host of user-friendly features, this compact, high power unit provides optimum amperage return and is designed to fully charge and maintain conventional and sealed maintenance free batteries.

- Fully automatic three level charge cycle for effective charging
- Reaches 14.4 volts peak, then automatically switches to float
- Designed to prevent overcharging
- AC power LED indicator
- Charging and float mode LED display
- Reverse polarity protection
- Spark-free operation
- Durable construction for longer life
- Battery accessory leads and fused ring connectors included
- 12 ft. output cord
- 3 year limited warranty



| DESCRIPTION                                  | PART #  |
|----------------------------------------------|---------|
| Ring Connector                               | 920-230 |
| 1.2 AMP Battery Charger                      | 258027  |
| 2 AMP Charger & Maintainer Dual Bank (6/12V) | 258050  |
| 3 AMP Charger & Maintainer (12V)             | 258051  |

## JUMPER CABLES

- Easy to use, easy to store
- Convenient storage bag
- Heavy duty, 8 ft., 8 gauge cables won't stiffen or freeze
- Tangle resistant, encased rubber grips for safer use



| DESCRIPTION   | PART #  |
|---------------|---------|
| Jumper Cables | 920-228 |

## ACID BOTTLE

This top-grade product is expertly made in compliance with stringent industry standards to offer a fusion of a well-balanced design and high level of craftsmanship. Manufactured from industry-leading materials using up-to-date equipment, it ensures everlasting reliability and enduring value. This product is distinguished by total quality assurance, unsurpassed by anybody else.

- Easy to use single use packaging
- Clean: no mess
- Prevents waste of good batteries when electrolyte is lost
- Pre-measured volume to completely fill specified battery

| YUASA MAINTENANCE FREE BATTERY ACID |              |        |
|-------------------------------------|--------------|--------|
| Description                         | MFG #        | Part # |
| YTX12-BS ACID BOTTLE                | 479911       | 258018 |
| YTX14(L)-BS ACID BOTTLE             | 479914       | 258019 |
| YTX20(L)-BS ACID BOTTLE             | 479971       | 258020 |
| YTX24HL-BS ACID BOTTLE              | 479916       | 258021 |
| Y130L-BS ACID BOTTLE                | 479919       | 258023 |
| 22oz. ACID BOTTLE                   | 4710065      | 258028 |
| YTX7L-BS ACID BOTTLE                | 5YT7LACDP    | 258016 |
| YTX20CH-BS ACID BOTTLE              | 479918       | 258022 |
| 32oz. ACID BOTTLES BOXED            | YUAACID32BOX | 258074 |



universal image



## BATTERY BOLT SET

| Description                                            | MFG #     | Part #  |
|--------------------------------------------------------|-----------|---------|
| Replacement Brass Nut/Bolt Set                         | 479643    | 258061  |
| 16MM NUT AND WASHER KIT                                | 5POLSS16M | 920-234 |
| 20MM, 12MM STAINLESS STEEL NUT WASHER AND BRASS SPACER | 479104    | 920-236 |
| 22 MM NUT AND BOLT SET                                 | 5BNBSS22M | 920-239 |
| BATTERY BOLT 14MM SET                                  | 479102    | 920-240 |



## BATTERY NUT BOLT SET

Universal Battery Nut Bolt Set (479100) by Yuasa®. For Y50-N18L-A3, YTX9-BS, YTX12-BS, YTX14-BS, YTX20CH, YTX14H-BS, YTX14AH-BS, YTX14AHL-BS, GYZ16H, YIX30L. This top-grade product is expertly made in compliance with stringent industry standards to offer a fusion of a well-balanced design and high level of craftsmanship. Manufactured from industry-leading materials using up-to-date equipment, it ensures everlasting reliability and enduring value. This product is distinguished by total quality assurance, unsurpassed by anybody else.

| Description                                     | MFG #   | Part #  |
|-------------------------------------------------|---------|---------|
| 12mm nut and bolt battery set                   | 479100  | 920-232 |
| 12mm hex bolt, square brass spacer, lock washer | 4710123 | 258062  |
| 12mm stainless hex bolt, lock washer            | 479699  | 258063  |





**ANTIGRAVITY  
BATTERIES**





**ANTIGRAVITY BATTERIES**

Located in Los Angeles, California, Antigravity Batteries is a company dedicated to building the best in Lithium-Ion Products for the Motorsports Community. We offer the highest quality, most innovative and diverse line of Lithium-Ion Battery Products to meet the demands of all Motorsports and Powersports enthusiasts and beyond. From our multi-award-winning MICRO-START jump-starters to our wide range of lightweight high-power Lithium-Ion batteries for Motorcycles, Powersports Vehicles, Race Cars and more... we are the lithium-ion battery specialists.

**AT7B-BS RE-START LITHIUM BATTERY**

The Antigravity AT7B-BS-RS is a lightweight lithium battery with built-in jump-starting (RESTART Technology), replacing the OEM YT7B-BS in the Ducati Panigale and more.



**ATZ10 RE-START LITHIUM BATTERY**

The Antigravity ATZ-10-RS is a lightweight lithium battery with RE-START Technology (built-in jump-starting), replacing the OEM YTZ10S and similar-sized lead-acid batteries.



| Description            | MFG #         | Part # |
|------------------------|---------------|--------|
| ANTIGRAVITY AT7B-BS-RS | AG-AT7B-BS-RS | 505038 |

| Description          | MFG #       | Part # |
|----------------------|-------------|--------|
| ANTIGRAVITY ATZ10-RS | AG-ATZ10-RS | 505040 |

**ATZ7 RE-START LITHIUM BATTERY**

The Antigravity ATZ-7-RS is a lightweight lithium battery with RESTART Technology (built-in jump-starting), replacing OEM YTZ7S, YTZ5, and more—ideal for most off-road and some street bikes.



**AT12BS RE-START LITHIUM BATTERY**

The Antigravity AT12BS-RS is a lightweight lithium battery with RESTART Technology (built-in jump-starting), replacing the OEM YT12-BS and also available in a Heavy Duty version.



| Description         | MFG #      | Part # |
|---------------------|------------|--------|
| ANTIGRAVITY ATZ7-RS | AG-ATZ7-RS | 505039 |

| Description           | MFG #        | Part # |
|-----------------------|--------------|--------|
| ANTIGRAVITY AT12BS-RS | AG-AT12BS-RS | 505041 |

## AT12BS-HD RE-START LITHIUM BATTERY

The Antigravity AT12BS-HD-RS is a high-power, lightweight lithium battery with RE-START Technology. This Heavy Duty version of the AT12-BS-RS offers increased capacity and cranking power.



## ATX20 RE-START LITHIUM BATTERY

The Antigravity ATX20-RS is a lightweight, high-power lithium battery with RE-START Technology, replacing the popular YTX-20 Series and other lead-acid batteries.



| Description              | MFG #           | Part # |
|--------------------------|-----------------|--------|
| ANTIGRAVITY AT12BS-HD-RS | AG-AT12BS-HD-RS | 505042 |

| Description          | MFG #       | Part # |
|----------------------|-------------|--------|
| ANTIGRAVITY ATX20-RS | AG-ATX20-RS | 505046 |

## ATX12 RE-START LITHIUM BATTERY

The Antigravity ATX12-RS is a lightweight lithium battery with RE-START Technology (built-in jump-starting), replacing the OEM YTX12 and also available in a Heavy Duty version.



## ATX20-HD LITHIUM BATTERY

The Antigravity ATX20-HD is a high-power, lightweight lithium battery that replaces the YTX-20 size. This Heavy Duty version offers increased power and amp-hour capacity.



| Description          | MFG #       | Part # |
|----------------------|-------------|--------|
| ANTIGRAVITY ATX12-RS | AG-ATX12-RS | 505043 |

| Description          | MFG #       | Part # |
|----------------------|-------------|--------|
| ANTIGRAVITY ATX20-HD | AG-ATX20-HD | 505047 |

## ATX12-HD RE-START LITHIUM BATTERY

The Antigravity ATX12-HD-RS is a high-power, lightweight lithium battery with RE-START Technology. This Heavy Duty version of the ATX12-RS delivers increased capacity and cranking power.



## ATX30 RE-START LITHIUM BATTERY

The Antigravity ATX30-RS is a lightweight, high-power lithium battery with RESTART Technology, replacing the OEM YTX30 and select YIX and GYZ lead-acid models.



| Description             | MFG #          | Part # |
|-------------------------|----------------|--------|
| ANTIGRAVITY ATX12-HD-RS | AG-ATX12-HD-RS | 505044 |

| Description          | MFG #       | Part # |
|----------------------|-------------|--------|
| ANTIGRAVITY ATX30-RS | AG-ATX30-RS | 505048 |

## ATX12-AH RE-START LITHIUM BATTERY

The Antigravity ATX12-AH-RS is a lightweight, high-power lithium battery with RE-START Technology (built-in jump-starting), replacing many OEM lead-acid models.



## SC-1 LITHIUM BATTERY

The Antigravity SC-1 is the world's smallest and most powerful motorsport battery, built for race motorcycles and powersports vehicles up to 1300cc. It offers twice the power of the 4-cell model with lower capacity.



| Description             | MFG #          | Part # |
|-------------------------|----------------|--------|
| ANTIGRAVITY ATX12-AH-RS | AG-ATX12-AH-RS | 505045 |

| Description                 | MFG #   | Part # |
|-----------------------------|---------|--------|
| ANTIGRAVITY SC-1 SMALL CASE | AG-SC-1 | 505050 |

## AG-401 LITHIUM BATTERY

The AG-401 is Antigravity's smallest and most compact lithium motorsport battery, perfect for race and performance use where maximum weight and space savings are essential.



## ATX30-HD LITHIUM BATTERY

The Antigravity ATX30-HD is a high-power, lightweight lithium battery that replaces YTX-30, YIX, and GYZ models. This Heavy Duty version offers increased power and capacity in a compact case.



| Description                | MFG #  | Part # |
|----------------------------|--------|--------|
| ANTIGRAVITY 401 SMALL CASE | AG-401 | 505057 |

| Description             | MFG #       | Part # |
|-------------------------|-------------|--------|
| ANTIGRAVITY AG-ATX30-HD | AG-ATX30-HD | 505065 |

## AG-801 LITHIUM BATTERY

The Antigravity AG-801 is a lightweight, powerful 8-cell lithium battery, known for its compact size and popularity in motorsports applications.



## AG-1201 LITHIUM BATTERY

The Antigravity AG-1201 is a high-power, lightweight lithium battery offering significant weight reduction in one of the most compact sizes in its class.



| Description                | MFG #  | Part # |
|----------------------------|--------|--------|
| ANTIGRAVITY 801 SMALL CASE | AG-801 | 505058 |

| Description                 | MFG #   | Part # |
|-----------------------------|---------|--------|
| ANTIGRAVITY 1201 SMALL CASE | AG-1201 | 505059 |

## AG-1601 LITHIUM BATTERY

The Antigravity AG-1601 is a compact, ultra-light 16-cell lithium battery delivering 480 cranking amps—ideal for those needing maximum power in minimal space.



| Description                 | MFG #   | Part # |
|-----------------------------|---------|--------|
| ANTIGRAVITY 1601 SMALL CASE | AG-1601 | 505060 |



**EMGO INTERNATIONAL**

EMGO is a trusted name in aftermarket motorcycle parts and accessories, offering reliable, affordable alternatives for riders worldwide. With over 50 years of experience, EMGO provides a wide range of products—from mirrors and mufflers to filters and electrical components—designed to fit a variety of bikes while delivering solid performance at great value.

**EMGO 6' CYCLE JUMPER CABLE SET**

A must-have for all PWC users. Great for motorcycles and snowmobiles too. Easier to store and use than automotive cables. Handy compact 10 gauge battery jumper cable set, insulated color coded terminal clamps for safe and secure handling.



**Features:**

- A must-have for all PWC users
- Great for motorcycles and snowmobiles too
- Easier to store and use than automotive cables
- Handy compact 10 gauge battery jumper cable set, insulated color coded terminal clamps for safe and secure handling

| Description           | MFG #    | Part #  |
|-----------------------|----------|---------|
| BATTERY JUMPER CABLES | 84-96306 | EM96300 |



## ALL BALLS RACING

All Balls Racing delivers unbeatable convenience, providing every part you need to get back to doing what you love. Built by gearheads with a passion for riding, All Balls Racing is the brand for those who believe the fun should never have to stop because of subpar parts. We work with everybody who loves powersports – whether dealers or DIYers — offering above-and-beyond support to all. From crankshaft kits to cylinder rebuilds, our kits give you the quickest, most cost-effective path to getting back on the road. And whether you're a dealer or a do-it-yourselfer, we're here to support you with legendary service.

### BATTERY CABLE SET

Durable, high-performance battery cable sets designed for reliable power transfer in powersports applications. Each set includes multiple pre-cut cables with factory-installed ring terminals for quick and secure connections. Available in clear or black insulation, these flexible, corrosion-resistant cables are ideal for motorcycles, ATVs, UTVs, and other 12V systems. Perfect for custom installs or replacing worn OEM cables.



| ALL BALLS BATTERY CABLE SET        |           |        |
|------------------------------------|-----------|--------|
| Description                        | MFG #     | Part # |
| BLACK, 1EA. 8", 1EA. 15", 1EA. 17" | 79-3001-1 | 132186 |
| CLEAR, 1EA. 10", 1EA. 12"          | 79-3002   | 132187 |
| BLACK, 1EA. 10", 1EA. 12"          | 78-3002-1 | 132188 |
| CLEAR, 1EA. 12", 2EA. 16"          | 79-3003   | 132189 |
| CLEAR, 1EA. 12", 1EA. 16"          | 79-3004   | 132191 |
| CLEAR, 2EA. 8", 1EA. 15"           | 79-3005   | 132193 |
| BLACK, 2 EA 8", 1EA. 15"           | 79-3005-1 | 132194 |
| BLACK, 1EA. 9", 2EA.16"            | 79-3006-1 | 132196 |
| BLACK, 1EA. 9", 2EA 30"            | 79-3007-1 | 132198 |
| CLEAR, 2EA. 13", 1EA. 8"           | 79-3009   | 132201 |
| BLACK, 1EA. 8", 2EA. 13"           | 79-3009-1 | 132202 |
| CLEAR 1EA. 11", 1EEA. 16"          | 79-3010   | 132203 |
| BLACK, 1EA. 11", 1EA. 16"          | 79-3010-1 | 132204 |
| BLACK, 2EA. 13"                    | 79-3011-1 | 132206 |



### 5/16" LUG TERMINAL 4 AWG KIT

Upgrade your electrical connections with the All Balls Racing 5/16" Lug Terminal 4 AWG Kit — part #99-1008. Designed for performance, durability, and secure connections, this kit is essential for any serious off-road, ATV, motorcycle, or powersports application where reliable wiring matters.



| Description                  | MFG #   | Part # |
|------------------------------|---------|--------|
| 5/16" Lug Terminal 4 AWG Kit | 99-1008 | 132248 |

### 3/8" RING TERMINAL 4 AWG

A dependable, heavy-duty ring terminal that brings durability, conductivity, and precision to your wiring setup. Perfect for high-current applications where solid, secure connections matter.



| Description                   | MFG #   | Part # |
|-------------------------------|---------|--------|
| 3/18" Ring Terminal 4 AWG Kit | 99-1009 | 132249 |

### BATTERY CABLE CRIMPING TOOL

Get precision, durability, and professional-grade performance with the All Balls Battery Cable Crimping Tool. Designed for those who demand reliable, high-quality electrical connections in powersports, automotive, or any high-current setup.



| Description                 | MFG #   | Part # |
|-----------------------------|---------|--------|
| Terminal Crimping Tool PKGD | 99-1012 | 132250 |

### HEAT SHRINK TUBE 1.5" - 0.5" (REPL 99-1010)

Ensure your battery cables and high-current connections are protected, insulated, and durable with this premium heat shrink sleeve from All Balls Racing. Replace the older 99-1010 with confidence using this updated 99-1024 sleeve.



| Description                | MFG #   | Part # |
|----------------------------|---------|--------|
| 1.5" - 0.5" (REPL 99-1010) | 99-1024 | 132251 |
| 1.5" - 0.5" RED KIT        | 99-1034 | 132252 |



TIRES & TRACKS

TUBES

CHEMICALS

TOOLS

BATTERIES

FUEL & INTAKE

AIR & OIL FILTERS

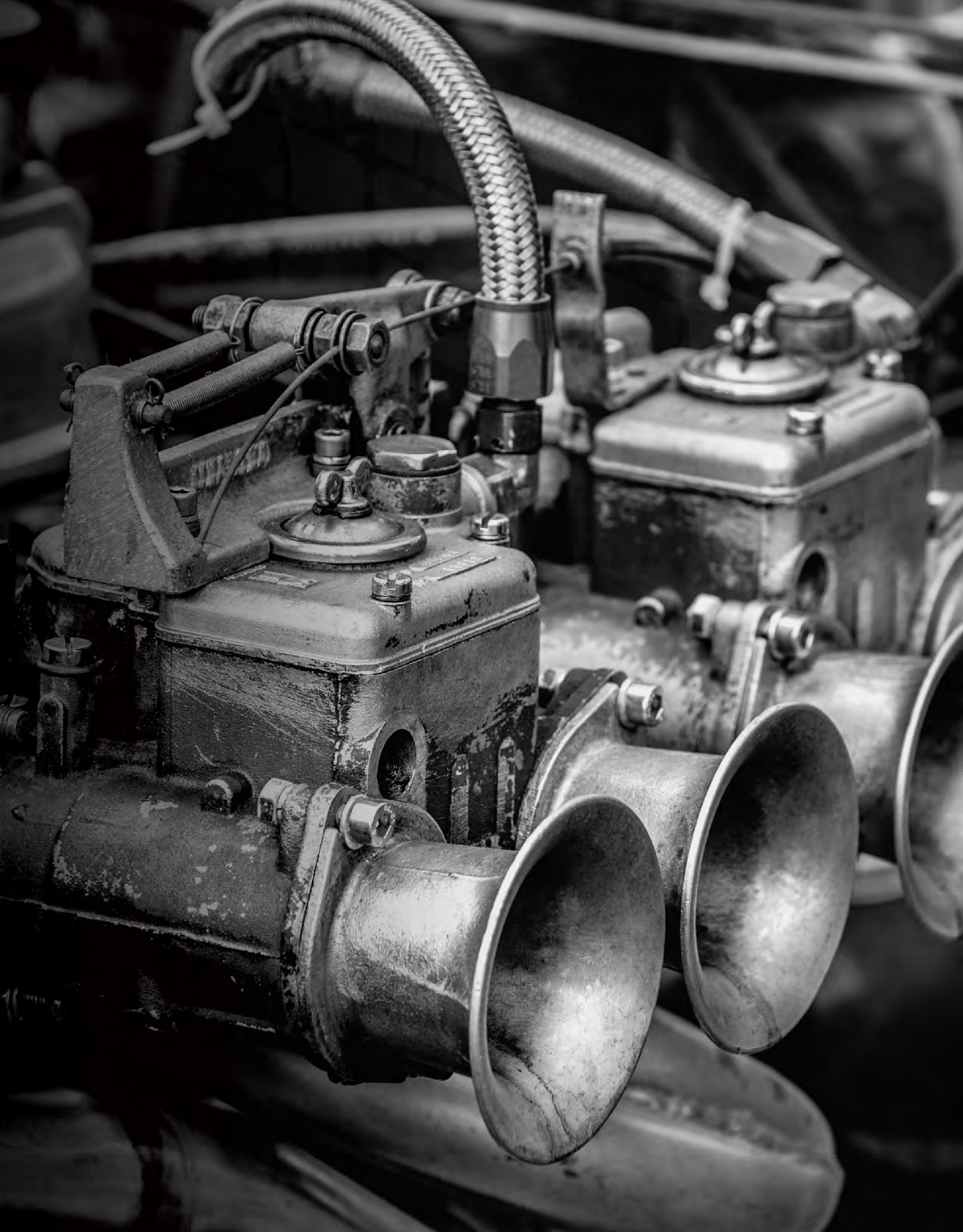

## TABLE OF CONTENTS

|                                     |                |
|-------------------------------------|----------------|
| <b>AUTOMATIC DISTRIBUTORS .....</b> | <b>476-477</b> |
| <b>EMGO .....</b>                   | <b>478-479</b> |
| <b>EBC BRAKES .....</b>             | <b>480-484</b> |
| <b>FUEL STAR .....</b>              | <b>485</b>     |
| <b>HELIX .....</b>                  | <b>486-487</b> |
| <b>KEIHIN .....</b>                 | <b>488-489</b> |
| <b>MIKUNI .....</b>                 | <b>500-525</b> |
| <b>MOTION PRO .....</b>             | <b>526-529</b> |
| <b>POLISPORT .....</b>              | <b>530-531</b> |
| <b>SPI .....</b>                    | <b>532-535</b> |

# **AUTOMATIC** DISTRIBUTORS

## BUTTON TYPE PRIMER KIT

- Rubber bulb-type primer kit
- Complete with filtered "T" fitting and primer hose
- Dash-mounted installation

**PK2250**



## UNIVERSAL MIKUNI PRIMER KIT

- Plunger type primer kit for engines with one or two Mikuni carburetors
- Includes brass inlet connector and 3 feet of fuel line
- Nickel/Chrome-plated brass body
- Made in USA

**PK2266**



**AUTOMATIC**  
DISTRIBUTORS



**EMGO FUEL FILTER CHROME  
GLASS 1/4"**



- Universal in-line fuel filter. Washable filter element. Includes fuel line clamps. Fuel inlet, and outlet are of equal size.
- Overall length, 3.1" (including fittings)
- Body length 1.44"
- OD cap - 1 inch
- OD glass body - .9 inch

**824130**

**EMGO GAS FUEL FILTER  
BLACK 1/4"**



- Customize and protect with the same filter
- CNC-machined aluminum outer case
- Cleanable brass filter element inside
- Available in black color
- Aluminum Fuel Filter - 1/4in.

**824132**

**EMGO FUEL FILTERS 2" (15  
PER CARD)**



- Sturdy nylon see thru fuel filter
- 11-12 gallons per hour capacity fuel flow
- Nylon screen traps all dirt particles
- 2in. length
- 1/4in.
- Set of 15

**EM34421**

**EMGO FUEL FILTERS 4" (10  
PER CARD) 1/4"**



- Jumbo in-line nylon fuel filter
- The nylon screen has a self-cleaning action
- 4" long
- 2 sizes 3/16" or 1/4"
- Sold each (bulk)

**EM34441**



**IEMIGO®**  
Your Powersport Supplier



**EMGO ANODIZED ALUMINUM FUEL FILTER, 5/16IN"**



- This Fuel Filter is designed to be an outstanding combination of quality filtration and aesthetic appeal
- The filter housing is matched from high strength aluminum alloy
- This fuel filter features a cleanable bronze filter element

| COLORS | 1/4"    | 5/16"   |
|--------|---------|---------|
| CHROME | EM34461 | EM34460 |
| RED    | EM34470 | EM34430 |
| BLUE   | EM34471 | EM34431 |
| PURPLE | EM34473 | EM34433 |
| GOLD   | EM34474 | EM34434 |



**EBC**  
BRAKES

**NEW**

**A-BAX PILOT JETS**

A-BAX Precision Engineering Ltd Pilot Jets for MIKUNI CARBS  
(Sold in packs of 4).



A-BAX  
Precision  
Engineering Ltd Pilot Jets  
for KEIHIN CARBS  
(Sold in packs of 4).

Jet Style - VM22/210  
8 bleed hole type  
VM18 / VM22 / VM26-34 Flange Type  
VM26-44 Spigot Type  
TM24-38 (No accelerator pump)  
Early TMX/TMXCarb Types

| SIZES | PART # |
|-------|--------|
| 10    | 167940 |
| 12.5  | 167941 |
| 15    | 167942 |
| 17.5  | 167943 |
| 20    | 167944 |
| 22.5  | 167945 |
| 25    | 167946 |
| 27.5  | 167947 |
| 30    | 167948 |
| 32.5  | 167949 |
| 35    | 167950 |
| 37.5  | 167951 |
| 40    | 167952 |
| 42.5  | 167953 |
| 45    | 167954 |
| 47.5  | 167955 |
| 50    | 167956 |
| 52.5  | 167957 |
| 55    | 167958 |
| 57.5  | 167959 |
| 60    | 167960 |
| 65    | 167961 |
| 70    | 167962 |
| 75    | 167963 |
| 80    | 167964 |
| 85    | 167965 |
| 90    | 167966 |
| 95    | 167967 |
| 100   | 167968 |
| 105   | 167969 |
| 110   | 167970 |
| 120   | 167971 |
| 130   | 167972 |
| 140   | 167973 |

Jet Style - BS30/96  
6 bleed hole type  
Various OEM BSrange CV carbs  
Kawasaki / Suzuki / Yamaha

| SIZES | PART # |
|-------|--------|
| 30    | 168037 |
| 32.5  | 168038 |
| 35    | 168039 |
| 37.5  | 168040 |
| 40    | 168041 |
| 42.5  | 168042 |
| 45    | 168043 |
| 47.5  | 168044 |
| 50    | 168045 |
| 52.5  | 168046 |
| 55    | 168047 |
| 57.5  | 168048 |
| 60    | 168049 |

Jet Style - VM28/486  
2mm bleed hole type  
HS40 / HSR42 / 45 / 48 / RS34-40  
TM33 / 36 / 40 with accelerator pump  
Kawasaki / Suzuki / Yamaha

| SIZES | PART # |
|-------|--------|
| 10    | 167974 |
| 12.5  | 167975 |
| 15    | 167976 |
| 17.5  | 167977 |
| 20    | 167978 |
| 22.5  | 167979 |
| 25    | 167980 |
| 27.5  | 167981 |
| 30    | 167982 |
| 32.5  | 167983 |
| 35    | 167984 |
| 37.5  | 167985 |
| 40    | 167986 |
| 42.5  | 167987 |
| 45    | 167988 |
| 47.5  | 167989 |
| 50    | 167990 |
| 52.5  | 167991 |
| 55    | 167992 |
| 57.5  | 167993 |
| 60    | 167994 |
| 62.5  | 167995 |
| 65    | 167996 |
| 67.5  | 167997 |
| 70    | 167998 |

Jet Style - M28/1001  
Yamaha P/No. 260-14142-Size  
Blaster/Banshee/LC

| SIZES | PART # |
|-------|--------|
| 15    | 168050 |
| 17.5  | 168051 |
| 20    | 168052 |
| 22.5  | 168053 |
| 25    | 168054 |
| 27.5  | 168055 |
| 30    | 168056 |
| 32.5  | 168057 |
| 35    | 168058 |
| 37.5  | 168059 |
| 40    | 168060 |
| 42.5  | 168061 |
| 45    | 168062 |
| 50    | 168063 |
| 52.5  | 168064 |
| 55    | 168065 |
| 57.5  | 168066 |
| 60    | 168067 |
| 62.5  | 168068 |
| 65    | 168069 |
| 67.5  | 168070 |
| 70    | 168071 |

Jet Style - N424-21  
Pilot / Slow Running Jet  
PB16 / 18 / 20  
Yamaha R6 99-07  
Various Kawasaki / Suzuki Quads

| SIZES | PART # |
|-------|--------|
| 35    | 167908 |
| 38    | 167909 |
| 40    | 167910 |
| 42    | 167911 |
| 45    | 167912 |
| 48    | 167913 |
| 50    | 167914 |
| 52    | 167915 |
| 55    | 167916 |
| 58    | 167917 |
| 60    | 167918 |
| 62    | 167919 |
| 65    | 167920 |
| 68    | 167921 |
| 70    | 167922 |
| 72    | 167923 |
| 75    | 167924 |
| 78    | 167925 |
| 80    | 167926 |

Jet Style - N151.067  
No bleed holes  
Later OEM BSrange CVcarbs  
Kawasaki / Suzuki / Yamaha

| SIZES | PART # |
|-------|--------|
| 30    | 168024 |
| 32.5  | 168025 |
| 35    | 168026 |
| 37.5  | 168027 |
| 40    | 168028 |
| 42.5  | 168029 |
| 45    | 168030 |
| 47.5  | 168031 |
| 50    | 168032 |
| 52.5  | 168033 |
| 55    | 168034 |
| 57.5  | 168035 |
| 60    | 168036 |

Jet Style - N224.103  
2.5mm bleed end  
Early TMS/TMX  
OEM MX36/38 BSR CVtype  
Honda / Kawasaki / Suzuki / Yamaha

| SIZES | PART # |
|-------|--------|
| 10    | 167999 |
| 12.5  | 168000 |
| 15    | 168001 |
| 17.5  | 168002 |
| 20    | 168003 |
| 22.5  | 168004 |
| 25    | 168005 |
| 27.5  | 168006 |
| 30    | 168007 |
| 32.5  | 168008 |
| 35    | 168009 |
| 37.5  | 168010 |
| 40    | 168011 |
| 42.5  | 168012 |
| 45    | 168013 |
| 47.5  | 168014 |
| 50    | 168015 |
| 52.5  | 168016 |
| 55    | 168017 |
| 57.5  | 168018 |
| 60    | 168019 |
| 62.5  | 168020 |
| 65    | 168021 |
| 67.5  | 168022 |
| 70    | 168023 |

**JET STYLE - N424-25**

Pilot / Slow Running Jet  
 FCR 28 / 32 / 33 / 35 / 37 / 39 / 41mm  
 Harley D Keihin BH (Non CVType)  
 Various Kawasaki / Yamaha Models with CVK / FCR / BD style  
 carbs

| SIZES | PART # |
|-------|--------|
| 35    | 167927 |
| 38    | 167928 |
| 40    | 167929 |
| 42    | 167930 |
| 45    | 167931 |
| 48    | 167932 |
| 50    | 167933 |
| 52    | 167934 |
| 55    | 167935 |
| 58    | 167936 |
| 60    | 167937 |
| 62    | 167938 |
| 65    | 167939 |



**A-BAX SLOT JETS FOR DELL 'ORTO'**

| (6413)<br>DO Prefix |        |
|---------------------|--------|
| SIZES (4-PACK)      | PART # |
| 70                  | 167881 |
| 75                  | 167882 |
| 80                  | 167883 |
| 85                  | 167884 |
| 90                  | 167885 |
| 95                  | 167886 |
| 100                 | 167887 |
| 105                 | 167888 |
| 110                 | 167889 |
| 115                 | 167890 |
| 120                 | 167891 |
| 125                 | 167892 |
| 130                 | 167893 |
| 135                 | 167894 |
| 140                 | 167895 |
| 145                 | 167896 |
| 150                 | 167897 |
| 155                 | 167898 |
| 160                 | 167899 |
| 165                 | 167900 |
| 170                 | 167901 |
| 175                 | 167902 |
| 180                 | 167903 |
| 185                 | 167904 |
| 190                 | 167905 |
| 195                 | 167906 |
| 200                 | 167907 |



## MAIN JETS & PILOT JETS

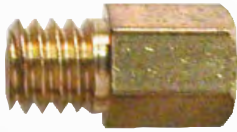

CARB VM32-34

- |        |        |
|--------|--------|
| LP4100 | LP4135 |
| LP4110 | LP4155 |
| LP4120 | LP4165 |
| LP4130 | LP4175 |
|        | LP4185 |

## MAIN JETS (4/042)

(Size Number Stamped on Jet)

CARB VM36-38

- LP4210  
LP4245  
LP4265

## PILOT JETS



VM20/210

LP555

**AFTERMARKET**

## MIKUNI / TILLOTSON CONVERSION KITS

KIT REPLACES TILLOTSON HR & WALLBRO WR SINGLE CARBURETORS

### KIT CONTAINS

- |   |                 |                 |
|---|-----------------|-----------------|
| 1 | <b>VM30S</b>    | 30MM Carburetor |
| 1 | <b>LP07467</b>  | Mounting Flange |
| 1 | <b>KX05138</b>  | Throttle Cable  |
| 1 | <b>LP05938</b>  | Choke Cable     |
| 1 | <b>DF44</b>     | Fuel Pump       |
| 1 | <b>LP077063</b> | Fuel Filter     |

CRK100

KIT REPLACES TILLOTSON HD & WALLBRO WD SINGLE CARBURETORS

Replaces the old Tillotson Carburetor on you snowmobile, ATV, etc. with a modern Mikuni carburetor and fuel pump\*

### KIT CONTAINS

- |   |                 |                 |
|---|-----------------|-----------------|
| 1 | <b>VM34S</b>    | 34MM Carburetor |
| 1 | <b>KX071013</b> | Mounting Flange |
| 1 | <b>LP05932</b>  | Throttle Cable  |
| 1 | <b>LP05938</b>  | Choke Cable     |
| 1 | <b>DF44</b>     | Fuel Pump       |
| 1 | <b>LP077063</b> | Fuel Filter     |

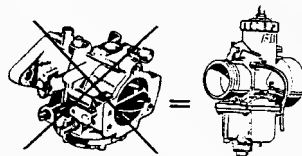

MIKUNI CARBURETOR TOOL KIT

CRK200

LP15866

## MIKUNI CHOKE CONVERSION KITS

Includes all parts necessary to convert lever operated choke carburetors (30-44mm) to cable operation. (Replaces VMCK).

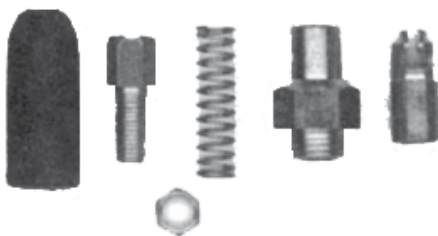

**AFTERMARKET**

LP07458

## NEEDLE AND SEAT FOR MIKUNI

Replaces VM281635 and fits all carburetors (VM30-44) (Aluminum spigot)



LP07410J

**AFTERMARKET**

## MIKUNI BUTTERFLY CARB REPAIR KIT

For Chaparral and Rupp models with Mikuni butterfly carbs that have a pump chamber on each side of the float bowl. Kit includes all necessary diaphragms and gaskets.

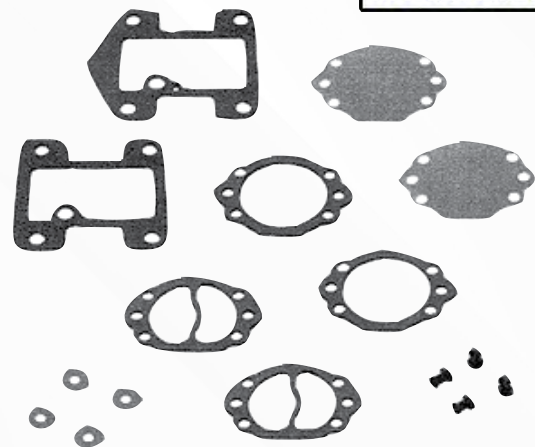

**AFTERMARKET**

CG1405

**WINDEROSA**  
HI PERFORMANCE CASSETS

# EBC BRAKES

## A-BAX HEX JETS FOR KEIHIN



| (357)<br>CR Prefix |        |
|--------------------|--------|
| SIZES              | 4-PACK |
| 80                 | 167530 |
| 82                 | 167531 |
| 85                 | 167532 |
| 88                 | 167533 |
| 90                 | 167534 |
| 92                 | 167535 |
| 95                 | 167536 |
| 98                 | 167537 |
| 100                | 167538 |
| 102                | 167539 |
| 105                | 167540 |
| 108                | 167541 |
| 110                | 167542 |
| 112                | 167543 |
| 115                | 167544 |
| 118                | 167545 |
| 122                | 167547 |
| 125                | 167548 |
| 128                | 167549 |
| 130                | 167550 |
| 132                | 167551 |
| 135                | 167552 |
| 138                | 167553 |
| 140                | 167554 |
| 142                | 167555 |
| 145                | 167556 |
| 148                | 167557 |
| 150                | 167558 |
| 155                | 167560 |
| 158                | 167561 |
| 162                | 167563 |
| 165                | 167564 |
| 168                | 167565 |
| 172                | 167567 |
| 175                | 167568 |
| 178                | 167569 |
| 180                | 167570 |
| 185                | 167572 |
| 190                | 167574 |
| 192                | 167575 |
| 195                | 167576 |
| 198                | 167577 |
| 200                | 167578 |
| 202                | 167579 |
| 205                | 167580 |
| 208                | 167581 |
| 210                | 167582 |
| 212                | 167583 |
| 215                | 167584 |
| 218                | 167585 |
| 220                | 167586 |
| 222                | 167587 |
| 225                | 167588 |
| 230                | 167590 |
| 232                | 167591 |
| 235                | 167592 |
| 238                | 167593 |

## A-BAX SLOT JETS FOR KEIHIN



| (N102 221)<br>KJ Prefix |        |
|-------------------------|--------|
| SIZES                   | 4-PACK |
| 75                      | 167659 |
| 77.5                    | 167660 |
| 80                      | 167661 |
| 82.5                    | 167662 |
| 85                      | 167663 |
| 87.5                    | 167664 |
| 90                      | 167665 |
| 92.5                    | 167666 |
| 95                      | 167667 |
| 97.5                    | 167668 |
| 100                     | 167669 |
| 102.5                   | 167670 |
| 105                     | 167671 |
| 107.5                   | 167672 |
| 110                     | 167673 |
| 112.5                   | 167674 |
| 115                     | 167675 |
| 117.5                   | 167676 |
| 120                     | 167677 |
| 122.5                   | 167678 |
| 125                     | 167680 |
| 127.5                   | 167681 |
| 130                     | 167682 |
| 132.5                   | 167683 |
| 135                     | 167684 |
| 137.5                   | 167685 |
| 140                     | 167686 |
| 142.5                   | 167687 |
| 145                     | 167688 |
| 147.5                   | 167689 |
| 150                     | 167690 |
| 152.5                   | 167691 |
| 155                     | 167692 |
| 160                     | 167694 |
| 165                     | 167695 |
| 170                     | 167696 |
| 185                     | 167697 |
| 190                     | 167698 |

## A-BAX HEX JETS FOR MIKUNI



| (4/042)<br>HJ Prefix |        |
|----------------------|--------|
| SIZES                | 4-PACK |
| 70                   | 167699 |
| 80                   | 167700 |
| 90                   | 167701 |
| 100                  | 167702 |
| 105                  | 167703 |
| 110                  | 167704 |
| 125                  | 167707 |
| 135                  | 167709 |
| 140                  | 167710 |
| 145                  | 167711 |
| 155                  | 167713 |
| 160                  | 167714 |
| 165                  | 167715 |
| 170                  | 167716 |
| 175                  | 167717 |
| 180                  | 167718 |
| 185                  | 167719 |
| 190                  | 167720 |
| 195                  | 167721 |
| 200                  | 167722 |
| 210                  | 167723 |
| 220                  | 167724 |
| 230                  | 167725 |
| 240                  | 167726 |
| 250                  | 167727 |
| 260                  | 167728 |
| 270                  | 167729 |
| 280                  | 167730 |
| 290                  | 167731 |
| 310                  | 167733 |
| 320                  | 167734 |
| 340                  | 167736 |
| 360                  | 167738 |
| 370                  | 167739 |
| 380                  | 167740 |
| 390                  | 167741 |
| 430                  | 167745 |
| 440                  | 167746 |
| 450                  | 167747 |
| 460                  | 167748 |
| 470                  | 167749 |
| 480                  | 167750 |
| 500                  | 167752 |
| 510                  | 167753 |
| 520                  | 167754 |
| 530                  | 167755 |
| 540                  | 167756 |
| 570                  | 167759 |
| 590                  | 167761 |
| 610                  | 167763 |
| 630                  | 167765 |
| 660                  | 167768 |
| 670                  | 167769 |
| 690                  | 167771 |

## A-BAX SLOT JETS FOR MIKUNI



| (N 100/604)<br>SJ Prefix |        |
|--------------------------|--------|
| SIZES                    | 4-PACK |
| 72.5                     | 167844 |
| 75                       | 167845 |
| 77.5                     | 167846 |
| 80                       | 167847 |
| 82.5                     | 167848 |
| 85                       | 167849 |
| 87.5                     | 167850 |
| 90                       | 167851 |
| 95                       | 167853 |
| 97.5                     | 167854 |
| 100                      | 167855 |
| 102.5                    | 167856 |
| 105                      | 167857 |
| 107.5                    | 167858 |
| 110                      | 167859 |
| 112.5                    | 167860 |
| 115                      | 167861 |
| 117.5                    | 167862 |
| 120                      | 167863 |
| 122.5                    | 167864 |
| 125                      | 167865 |
| 127.5                    | 167866 |
| 130                      | 167867 |
| 132.5                    | 167868 |
| 135                      | 167869 |
| 137.5                    | 167870 |
| 140                      | 167871 |
| 142.5                    | 167872 |
| 145                      | 167873 |
| 150                      | 167875 |
| 152.5                    | 167876 |
| 155                      | 167877 |
| 157.5                    | 167878 |
| 160                      | 167879 |
| 170                      | 167880 |

### A-BAX PRECISION ENGINEERING LTD MAIN JETS



Made in the UK, these high precision Brass carburettor jets are available in dealer selection kits or in top-up packs of 5 jets or 4 jets. All jets are flow calibrated and extremely accurate in terms of fuel flow rate as stamped.

#### DEALER SELECTION KITS

| KIT TYPE             | EBC NO. | PART #        | DESCRIPTION                       | CONTENTS |
|----------------------|---------|---------------|-----------------------------------|----------|
| MIKUNI SLOT MAIN JET | SJK36   | <b>168072</b> | 4PC EACH JET SIZES 72.5 THRU 160  | 144 JETS |
| MIKUNI HEX MAIN JET  | HJK27A  | <b>168073</b> | 2 PCS EACH JET SIZES 70 THRU 230  | 54 JETS  |
| MIKUNI HEX MAIN JET  | HJK27B  | <b>168074</b> | 2 PCS EACH JET SIZES 240-500      | 54 JETS  |
| KEIHIN SLOT MAIN JET | KJK30   | <b>168075</b> | 4 PCS EACH JET SIZES 80-190       | 132 JETS |
| KEIHIN HEX MAIN JET  | CRK32A  | <b>168076</b> | 2 PCS EACH JET SIZES 80 THRU 158  | 64 JETS  |
| KEIHIN HEX MAIN JET  | CRK32B  | <b>168077</b> | 2 PCS EACH JET SIZES 160 THRU 235 | 64 JETS  |



EACH KIT CONTAINS ONE PILOT JET PER SIZE

### A-BAX DEALER PILOT JET SELECTION KIT

| KIT #         | CARB MODEL TYPE | JET STYLE | SIZES  | QTY PER KIT |
|---------------|-----------------|-----------|--------|-------------|
| <b>168079</b> | KEIHIN          | N424-21   | 35-80  | 19          |
| <b>168080</b> | KEIHIN          | N424-25B  | 35-65  | 13          |
| <b>168081</b> | MIKUNI          | VM22/210  | 10-140 | 34          |
| <b>168082</b> | MIKUNI          | N224.103  | 10-70  | 25          |
| <b>168083</b> | MIKUNI          | N151.067  | 30-60  | 13          |
| <b>168084</b> | MIKUNI          | BS30/96   | 30-60  | 13          |
| <b>168085</b> | MIKUNI          | M28/486   | 10-70  | 25          |





**HOSE CLAMP KIT & REFILLS**



**HOSE CLAMP KIT**

The ultimate fuel line clamp kit! An absolute necessity for any Shop, Technician, or DIY Mechanic. This kit comes with 4 of each Fuel Star fuel line OEM replica clamps, available in sizes from 7-17mm I.D. Each clamp is an exact replica of the major OEM's fuel line clamps, and is manufactured to meet or exceed OEM performance, aesthetics, and fit. Why mess with those clumsy, cheesy appearing worm gear clamps when you can get OEM appearance and performance for a fraction of the price?

**833851**

**HOSE CLAMP 4PK KIT REFILLS**

| DESCRIPTION                                                           | PART #        |
|-----------------------------------------------------------------------|---------------|
| FS013-0011 Clamp Refill Kit - Contains 4 wire type clamps 11.5mm I.D. | <b>833853</b> |
| FS013-0012 Clamp Refill Kit - Contains 4 band type clamps 12mm I.D.   | <b>833854</b> |
| FS013-0013 Clamp Refill Kit - Contains 4 wire type clamps 14.3mm I.D. | <b>833855</b> |
| FS013-0014 Clamp Refill Kit - Contains 4 wire type clamps 13.5mm I.D. | <b>833856</b> |
| FS013-0015 Clamp Refill Kit - Contains 4 wire type clamps 15.2mm I.D. | <b>833857</b> |
| FS013-0018 Clamp Refill Kit - Contains 4 wire type clamps 10.8mm I.D. | <b>833859</b> |
| FS013-0019 Clamp Refill Kit - Contains 4 wire type clamps 9mm I.D.    | <b>833860</b> |
| FS013-0021 Clamp Refill Kit - Contains 4 wire type clamps 9.8mm I.D.  | <b>833862</b> |
| FS013-0023 Clamp Refill Kit - Contains 4 band type clamps 11.7mm I.D. | <b>833863</b> |
| FS013-0024 Clamp Refill Kit - Contains 4 wire type clamps 9mm I.D.    | <b>833864</b> |
| FS013-0025 Clamp Refill Kit - Contains 4 wire type clamps 10.3mm I.D. | <b>833865</b> |
| FS013-0026 Clamp Refill Kit - Contains 4 band type clamps 10.4mm I.D. | <b>833866</b> |
| FS013-0027 Clamp Refill Kit - Contains 4 band type clamps 12mm I.D.   | <b>833867</b> |
| FS013-0028 Clamp Refill Kit - Contains 4 wire type clamps 12mm I.D.   | <b>833868</b> |
| FS013-0029 Clamp Refill Kit - Contains 4 wire type clamps 7.6mm I.D.  | <b>833869</b> |
| FS013-0030 Clamp Refill Kit - Contains 4 band type clamps 10mm I.D.   | <b>833870</b> |
| FS013-0031 Clamp Refill Kit - Contains 4 band type clamps 10mm I.D.   | <b>833871</b> |
| FS013-0032 Clamp Refill Kit - Contains 4 wire type clamps 12.5mm I.D. | <b>833872</b> |
| FS013-0033 Clamp Refill Kit - Contains 4 wire type clamps 10mm I.D.   | <b>833873</b> |
| FS013-0034 Clamp Refill Kit - Contains 4 band type clamps 11mm I.D.   | <b>833874</b> |
| FS013-0035 Clamp Refill Kit - Contains 4 wire type clamps 9.9mm I.D.  | <b>833875</b> |
| FS013-0037 Clamp Refill Kit - Contains 4 wire type clamps 7.1mm I.D.  | <b>833876</b> |
| FS013-0038 Clamp Refill Kit - Contains 4 wire type clamps 9.2mm I.D.  | <b>833877</b> |
| FS013-0039 Clamp Refill Kit - Contains 4 wire type clamps 10.1mm I.D. | <b>833878</b> |
| FS013-0040 Clamp Refill Kit - Contains 4 band type clamps 8mm I.D.    | <b>833879</b> |



**HELIX TRANSPARENT TUBING AND HOSE**

Helix® Fuel line is a premium polyurethane, 85 durometer, which provides for superior abrasions and kink, tear, oxidation and chemical resistance. Melting temp 370f. Operating temp -75f to 155f. Very strong and stays flexible.

| SIZES        | PART # |        |        |
|--------------|--------|--------|--------|
|              | RED    | BLUE   | CLEAR  |
| 1/8" x 5 FT  | 920000 | 920001 | 920002 |
| 3/16" x 3 FT | 920003 | 920004 | 920005 |
| 1/4" x 3 FT  | 920006 | 920007 | 920008 |
| 5/16" x 3 FT | 920009 | 920010 | 920011 |
| 3/8" x 3 FT  | 920012 | 920013 | 920014 |

**HOSE CLAMPS**



- Double wire
- Self tensioning
- Zinc plated
- For use with 5/16" OD hose thru 7/16" hose

| SIZES              | PART # |
|--------------------|--------|
| 15 Pack Assorted   | 920023 |
| 150 Pack Assorted  | 920024 |
| 5/16" OD 150 Pack  | 920025 |
| 3/8" OD 150 Pack   | 920026 |
| 7/16" OD 150 pack) | 920027 |



**HELIX OPAQUE TUBING AND HOSE**

Helix® Fuel line is a premium polyurethane, 85 durometer, which provides for superior abrasions and kink, tear, oxidation and chemical resistance. Melting temp 370f. Operating temp -75f to 155f. Very strong and stays flexible.

| SIZES        | PART # |
|--------------|--------|
| 1/8" x 5 FT  | 920015 |
| 3/16" x 3 FT | 920016 |
| 1/4" x 3 FT  | 920017 |
| 5/16" x 3 FT | 920018 |
| 3/8" x 3 FT  | 920019 |



**HOSE PROTECTORS**

- Stainless steel
- Fits on the outside of hoses and tubing
- Protects hoses from rips, tears and hot engine parts

| SIZES                | PART # |
|----------------------|--------|
| 1.5" diameter (38MM) | 920028 |
| 1.0" diameter (25MM) | 920029 |
| 3/8" diameter (9MM)  | 920031 |



**HELIX TRANSPARENT TUBING 25' ROLLS**

| SIZES           | RED    | YELLOW | GREEN  | BLUE   | CLEAR  | BLACK  |
|-----------------|--------|--------|--------|--------|--------|--------|
| 1/4" ID X 25 FT | 920052 | 920053 | 920054 | 920055 | 920056 |        |
| 3/16" ID X 25FT | 920060 | 920061 | 920062 | 920063 | 920064 | 920065 |
| 3/8" X 25FT     | 920066 | 920067 | 920068 | 920069 | 920070 | 920071 |
| 5/16" X 25 FT   | 920072 | 920073 | 920074 | 920075 | 920076 | 920077 |



**OE BLACK FI FUEL INJECTION LINE**

- Made of black rubber, extruded with multi-layers for safety and performance.
- Meets SAE, EPA and C.A.R.B. standards for all powersports, offroad and on-road.
- Helix OE-black fuel line is safe for all types of fuel including ethanol blends up to 100% to include E-10, E-15, E-30 and E-85.
- For gravity and suction feed applications, not for FI, 50 PSI max working pressure.

| SIZES        | PART # |
|--------------|--------|
| 1/4" X 3FT   | 920058 |
| 1/4" X 10FT. | 920059 |





**KEIHIN SCREW, COVER**

- KEIHIN SCREW, COVER - CRP00006
- 0135-828 Screw
- Fits CDK/CDKII

**914007**



**KEIHIN NUT, CABLE ADJUSTER**

- KEIHIN NUT, CABLE ADJUSTER - CRP00016
- KEIHIN PJ SERIES REPLACEMENT PART.
- \* Cable adjuster nut.
- \* Fits: PJ34mm, PJ36mm, and PJ38mm.

| DESCRIPTIONS | PART #        |
|--------------|---------------|
| CRP00016     | <b>914017</b> |
| CRP00683     | <b>916067</b> |



**KEIHIN CLIP, FLOAT VALVE**

- KEIHIN CLIP, FLOAT VALVE - CRP00031
- Float Valve Clip for FCR, CR Special, PWK, PWM carbs

| DESCRIPTIONS | PART #        |
|--------------|---------------|
| CRP00031     | <b>914032</b> |
| CRP00681     | <b>916065</b> |



**KEIHIN THR. LEVER**

- KEIHIN THR. LEVER B - CRP00066
- KEIHIN THR. LEVER C - CRP00067
- TH Lever B for cdk11 carburetor

| DESCRIPTIONS | PART #        |
|--------------|---------------|
| THR. LEVER B | <b>914170</b> |
| THR. LEVER C | <b>914171</b> |



**KEIHIN TOP**

- Keihin Top - CRP00081, CRP00670, CRP00671
- KEIHIN Carburetor Top Cap Fits PWK 33-41mm

| DESCRIPTIONS | PART #        |
|--------------|---------------|
| CRP00081     | <b>914185</b> |
| CRP00670     | <b>916054</b> |
| CRP00671     | <b>916055</b> |



**KEIHIN IDLE ADJUSTER, BRASS**

- KEIHIN Brass Idle Adjuster - CRP00095
- Fits PWK 33-41mm w/Non-Chrome Slide

**914199**



**KEIHIN CABLE ADJUSTER**

- KEIHIN CABLE ADJUSTER CRP00104

**914208**



**KEIHIN IDLE ADJUSTER**

- KEIHIN IDLE ADJUSTER CRP00100

**914204**



**KEIHIN FLOAT VALVE (3.2-4.0)**

- Keihin Float Valve (3.2-4.0) - CRP00130
- KEIHIN Float Valve Fits FCR-H, PWK 33-41mm, PWM 38mm

**914234**



**KEIHIN NEEDLE VALVE**

- KEIHIN NEEDLE VALVE - CRP00131
- 1062-818 Needle Valve
- Fits CDKII, CDKII w/Acc. Pump

**914235**



**KEIHIN PRODUCTS KEIHIN JET NEEDLE-48 SERIES, #CCJ**

- OEM# N427-48CCJ
- PE 36MM, PJ 34-38MM, PWK 33-41MM, PWM 38MM

**915609**



**KEIHIN CABLE HOLDER**

- KEIHIN CABLE HOLDER CRP00155, CRP00316
- KEIHIN PJ Series Cable Holder
- Fits: PJ34mm, PJ36mm, and PJ38mm
- KEIHIN CARBURETOR REPLACEMENT PART.
- \* Cable holder.
- \* Fits PWK33, PWK35, PWK33 Air Striker, and PWK35 Air Striker.

| DESCRIPTIONS | PART #        |
|--------------|---------------|
| CRP00155     | <b>914262</b> |
| CRP00316     | <b>914415</b> |

## KEIHIN COLLAR



- KEIHIN COLLAR - CRP00164
- KEIHIN replacement collar
- Fits PWK33, PWK35, PWK33 Air Striker, and PWK35 Air Striker.
- CR Special

**914271**



## KEIHIN STARTER VALVE

- KEIHIN Starter Valve - CRP00187
- Fits PWK33, PWK35, PWK35 Air Striker, and PWK38 Air Striker

**914295**

## KEIHIN DIAPHRAGM COMP.



- KEIHIN DIAPHRAGM COMP. CRP00205
- CDKII, CDKII w/Acc. Pump

**914313**

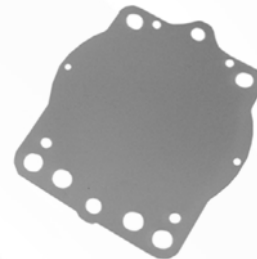

## KEIHIN DIAPHRAGM

- KEIHIN DIAPHRAGM - CRP00206
- 1201-825 Diaphragm
- CDKII, CDKII with accelerator pump

**914314**

## KEIHIN GASKET



- KEIHIN GASKET - CRP00211 and CRP00212
- 1202-822 Gasket
- CDKII, CDKII with accelerator pump

| MFG #    | PART #        |
|----------|---------------|
| CRP00211 | <b>914319</b> |
| CRP00212 | <b>914320</b> |



## KEIHIN GASKET, FUEL PUMP

- KEIHIN GASKET, FUEL PUMP - CRP00217
- 1202-851 Gasket
- Fits CDKII, CDKII with accelerator pump

**914325**

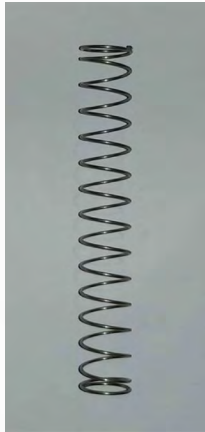

**KEIHIN THROTTLE SPRING**

- KEIHIN THROTTLE SPRING CRP00244, CRP00245
- KEIHIN. Throttle spring. PWK 38-41mm (Except Snowmobile).

| MFG #    | PART #        |
|----------|---------------|
| CRP00244 | <b>914343</b> |
| CRP00245 | <b>914344</b> |



**KEIHIN JET NEEDLE**

- KEIHIN Polaris Needle Jet R1368G
- PWK 39mm, Snowmobile

| DESCRIPTIONS | PART #        |
|--------------|---------------|
| 1368G        | <b>916092</b> |
| 1369G        | <b>916093</b> |
| 1370G        | <b>916096</b> |
| 1371J        | <b>916100</b> |



**KEIHIN COIL SPRING**

- 1290-992 Spring
- Fits CDKII w/Acc. Pump

| DESCRIPTIONS | PART #        |
|--------------|---------------|
| 70 GR.       | <b>914348</b> |
| 40 GR.       | <b>914351</b> |
| 40 GR.       | <b>914352</b> |



**KEIHIN COIL SRING, IDLE ADJUSTER**

- KEIHIN COIL SRING, IDLE ADJUSTER - CRP00251
- KEIHIN Idle Adjuster Spring
- Fits PWK 28mm w/Chrome Slide

**914350**



**KEIHIN ANCHOR PLATE**

- KEIHIN ANCHOR PLATE - CRP00285
- KEIHIN PJ Series Vent Tube Anchor Plate
- Fits: PJ34mm, PJ36mm, and PJ38mm.

**914384**



**KEIHIN CHOKE VALVE**

- KEIHIN CHOKE VALVE - CRP00287, CRP00289
- CRP00289 - KEIHIN PJ Series Choke Valve, Fits PJ38mm carbs
- CRP00287 - KEIHIN PJ SERIES REPLACEMENT PART.
- \* Choke valve.
- \* Fits: PJ34mm and PJ36mm.

| MFG #    | PART #        |
|----------|---------------|
| CRP00287 | <b>914386</b> |
| CRP00289 | <b>914388</b> |

## KEIHIN THROTTLE SPRING



- Keihin Throttle Spring - CRP00293
- CR PRO THROTTLES AND KITS: Throttle features die-cast aluminum housing with black epoxy finish; chrome CR Pro throttle also available separately. Straight-pull assembly. Recommended for 34mm or smaller straight-pull carburetors. 4 1/2" throttle sleeve with grip retaining ring and pop-out end cap.

**914392**

## KEIHIN THROTTLE VALVE SPRING



- KEIHIN THROTTLE VALVE SPRING - CRP00295
- KEIHIN PJ Series Throttle Valve Spring
- Fits PJ38mm

**914394**

## KEIHIN SPRING

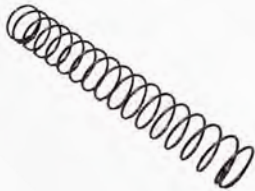

- CR COMP THROTTLES AND KITS
- Kit includes Motion Pro CR Comp throttle, throttle cable, and installation instructions.
- Designed for ultimate throttle performance.
- KEIHIN SPRING.

**914395**

## KEIHIN GASKET, TOP COVER



- KEIHIN GASKET, TOP COVER - CRP00311
- KEIHIN PJ SERIES Mixing Chamber Cap
- Fits PJ 34-36mm

**914410**

## KEIHIN CLIP, JET NEEDLE



- \*no image in the internet

**914412**

## KEIHIN CAP, CABLE ADJUSTER



- KEIHIN CAP, CABLE ADJUSTER - CRP00314
- KEIHIN PJ Series Cable Adjuster Cap
- Fits: PJ34mm, PJ36mm, and PJ38mm, PWK-all, PWM 38mm, PE-20-30mm

**914413**



**KEIHIN FLOAT VALVE**

- KEIHIN FLOAT VALVE - CRP00322
- KEIHIN PJ Series Float valve
- Fits PJ34mm, PJ36mm, and PJ38mm

**914421**



**KEIHIN FL. VALVE  
(#W9522-53001),  
1.0-2.6 VALVE SEAT**

- CRP00323
- KEIHIN NEEDLE VALVE POLARIS SNOWMOBILE
- FCR-D

**914422**



**KEIHIN DRAIN BOLT, FLOAT BOWL**

- KEIHIN DRAIN BOLT, FLOAT BOWL - CRP00324
- KEIHIN PJ SERIES REPLACEMENT PART.
- \* Main jet plug.
- \* Fits: PJ34mm, PJ36mm, and PJ38mm.
- FCR-MX, PWK 28 mm, PWK3-39mm, PWM 38mm

**914423**



**KEIHIN GASKET, FLOAT BOWL**

- KEIHIN GASKET, FLOAT BOWL - CRP00325
- KEIHIN PJ SERIES REPLACEMENT PART.\* Float bowl gasket.\* Fits: PWK 33-39mm, PWM 38mm

**914424**



**KEIHIN O-RING, PLUG SCRW**

- KEIHIN O-RING, PLUG SCRW - CRP00330
- FCR-MX, CR Special, PWK-All, PJ-All, PWM 38mm, PE-All

**914430**



**KEIHIN HOSE RETAINER**

- KEIHIN HOSE RETAINER - CRP00333
- KEIHIN Carburetor Anchor plate
- Fits PWK 35-38mm Q.Vent-Air Striker and FCR-MX

**914433**



## KEIHIN OVERFLOW HOSE

- KEIHIN OVERFLOW HOSE - CRP00373, CRP00375
- KEIHIN Overflow pipe
- Fits PWK 33-41mm (Except Snowmobile)

| MFG #    | PART #        |
|----------|---------------|
| CRP00373 | <b>914466</b> |
| CRP00375 | <b>914468</b> |



## KEIHIN VENT HOSE ASSY.

- KEIHIN VENT HOSE ASSY. - CRP00336
- KEIHIN CARBURETOR REPLACEMENT PART.
- \* Bowl vent pipe comp.
- \* PWK 35-38mm Q.Vent-A.S.

**914436**



## KEIHIN VENT HOSE, FLOAT BOWL

- KEIHIN VENT HOSE, FLOAT BOWL - CRP00381
- KEIHIN Carb Bowl Vent Pipe
- Fits PWK 28mm / PWK 33-36mm

**914474**



## KEIHIN OVERFLOW HOSE/ VENT HOSE

- KEIHIN OVERFLOW HOSE/VENT HOSE - CRP00380
- KEIHIN Carb Bowl Vent Pipe
- Fits PWK 28mm / PWK 33-36mm

**914473**



## KEIHIN FLOAT PIN

- KEIHIN FLOAT PIN - CRP00695
- KEIHIN PJ Series Float Pin
- Fits: FCR-D/H, FCR-MX, CR Special, PWK All, PJ 34-38mm, PWM, PE All

**916085**



## KEIHIN CLIP, VENT HOSE

- KEIHIN CLIP, VENT HOSE - CRP00696
- KEIHIN Vent Hose Clip
- Fits: PWK All, PJ, PWM, PE All

**916086**

## KEIHIN BAFFLE PLATE



- KEIHIN BAFFLE PLATE - CRP00335
- KEIHIN PJ SERIES REPLACEMENT PART.\* Baffle plate.\* Fits: PJ34mm, PJ36mm, and PJ38mm.

**914435**

## KEIHIN SCREW, 4X25MM - FLOAT BOWL



- KEIHIN SCREW, 4X25MM - FLOAT BOWL - CRP00370
- KEIHIN PJ SERIES REPLACEMENT PART.
- Float bowl screw.
- PWK 33-41mm, PJ-All, PE-All

**914463**

## KEIHIN SCREW, PAN 4X8MM



- KEIHIN SCREW, PAN 4X8MM - CRP00365
- 93500-04008 Pan-Head Screw
- FCR-D/H, CDKII, CDKII with accelerator pump

**914458**

## KEIHIN ROUND MAIN JETS

|     | PART #        |
|-----|---------------|
| 145 | <b>914644</b> |
| 148 | <b>914645</b> |
| 150 | <b>914646</b> |
| 152 | <b>914647</b> |
| 155 | <b>914648</b> |
| 158 | <b>914649</b> |
| 160 | <b>914650</b> |
| 162 | <b>914651</b> |
| 165 | <b>914652</b> |
| 170 | <b>914654</b> |
| 172 | <b>914655</b> |
| 175 | <b>914656</b> |

ROUND MAIN AIR JET-393 SERIES

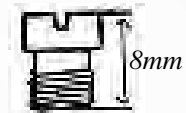

## KEIHIN MAIN JETS

|     | PART #        |
|-----|---------------|
| 80  | <b>914555</b> |
| 82  | <b>914556</b> |
| 85  | <b>914557</b> |
| 88  | <b>914558</b> |
| 90  | <b>914559</b> |
| 92  | <b>914560</b> |
| 95  | <b>914561</b> |
| 98  | <b>914562</b> |
| 102 | <b>914564</b> |
| 105 | <b>914565</b> |
| 108 | <b>914566</b> |
| 110 | <b>914567</b> |
| 112 | <b>914568</b> |
| 115 | <b>914569</b> |
| 118 | <b>914570</b> |
| 120 | <b>914571</b> |
| 122 | <b>914572</b> |
| 125 | <b>914573</b> |
| 128 | <b>914574</b> |
| 130 | <b>914575</b> |
| 132 | <b>914576</b> |
| 135 | <b>914577</b> |
| 138 | <b>914578</b> |
| 140 | <b>914579</b> |
| 145 | <b>914581</b> |
| 148 | <b>914582</b> |

MAIN JET-357 SERIES

|     |               |
|-----|---------------|
| 150 | <b>914583</b> |
| 152 | <b>914584</b> |
| 155 | <b>914585</b> |
| 158 | <b>914586</b> |
| 160 | <b>914587</b> |
| 165 | <b>914589</b> |
| 168 | <b>914590</b> |
| 170 | <b>914591</b> |
| 172 | <b>914592</b> |
| 175 | <b>914593</b> |
| 178 | <b>914594</b> |
| 180 | <b>914595</b> |
| 182 | <b>914596</b> |
| 185 | <b>914597</b> |
| 188 | <b>914598</b> |
| 190 | <b>914599</b> |
| 195 | <b>914601</b> |
| 200 | <b>914603</b> |
| 205 | <b>914604</b> |
| 210 | <b>914605</b> |
| 215 | <b>914606</b> |
| 220 | <b>914607</b> |
| 230 | <b>914609</b> |

MAIN JET-116 SERIES

|     | PART NO.      |
|-----|---------------|
| 080 | <b>914487</b> |

## KEIHIN SLOW JETS

|    | PART #        |
|----|---------------|
| 35 | <b>914877</b> |
| 38 | <b>914878</b> |
| 40 | <b>914879</b> |
| 42 | <b>914880</b> |
| 45 | <b>914881</b> |
| 48 | <b>914882</b> |
| 50 | <b>914883</b> |
| 52 | <b>914884</b> |
| 55 | <b>914885</b> |
| 58 | <b>914886</b> |
| 60 | <b>914887</b> |
| 62 | <b>914888</b> |
| 65 | <b>914889</b> |
| 68 | <b>914890</b> |
| 70 | <b>914891</b> |
| 72 | <b>914892</b> |
| 75 | <b>914893</b> |
| 78 | <b>914894</b> |
| 80 | <b>914895</b> |

SLOW JET-21 SERIES



**N427-48"XXX" PJ34-38, PWK33-39, PWM38**

| JET NEEDLE                         |         | 1/6 TO 1/4 Throttle                                                                     |  |     |  |     |  |     |  |     |  |     |  |     |  |     |  |     |  |     |  |     |  |     |  |     |  |     |  |
|------------------------------------|---------|-----------------------------------------------------------------------------------------|--|-----|--|-----|--|-----|--|-----|--|-----|--|-----|--|-----|--|-----|--|-----|--|-----|--|-----|--|-----|--|-----|--|
| 1 <sup>st</sup> Letter Designation |         | Diameter (d-1) mm                                                                       |  |     |  |     |  |     |  |     |  |     |  |     |  |     |  |     |  |     |  |     |  |     |  |     |  |     |  |
| TAPER                              |         | A=2.605 E=2.645 F=2.655 G=2.665 H=2.675 J=2.685 K=2.695 L=2.705 M=2.715 N=2.725 Q=2.745 |  |     |  |     |  |     |  |     |  |     |  |     |  |     |  |     |  |     |  |     |  |     |  |     |  |     |  |
| 2 <sup>nd</sup> Letter Designation |         |                                                                                         |  |     |  |     |  |     |  |     |  |     |  |     |  |     |  |     |  |     |  |     |  |     |  |     |  |     |  |
| LENGTH IN MM                       |         |                                                                                         |  |     |  |     |  |     |  |     |  |     |  |     |  |     |  |     |  |     |  |     |  |     |  |     |  |     |  |
| 3 <sup>rd</sup> Letter Designation |         |                                                                                         |  |     |  |     |  |     |  |     |  |     |  |     |  |     |  |     |  |     |  |     |  |     |  |     |  |     |  |
| DIAMETER                           |         |                                                                                         |  |     |  |     |  |     |  |     |  |     |  |     |  |     |  |     |  |     |  |     |  |     |  |     |  |     |  |
| C<br>1' 34'                        | C=36.35 | RICH                                                                                    |  | A   |  | E   |  | F   |  | G   |  | H   |  | J   |  | K   |  | L   |  | M   |  | N   |  | Q   |  |     |  |     |  |
|                                    | E=38.15 | 1/4 Throttle                                                                            |  | CGG |  | CGH |  | CGJ |  | CGK |  | CCL |  | CCM |  | CCN |  | CCQ |  | CEG |  | CEH |  | CEJ |  | CEK |  |     |  |
|                                    | G=39.95 | LEAN                                                                                    |  | CGF |  | CGG |  | CGH |  | CGJ |  | CGK |  | CGL |  | CGM |  | CGN |  | CGQ |  | CEG |  | CEH |  | CEJ |  | CEK |  |
| D<br>1' 45'                        | C=36.35 | RICH                                                                                    |  | DCA |  | DCE |  | DCF |  | DEG |  | DGH |  | DEJ |  | DEK |  | DEL |  | DEM |  | DEN |  | DEQ |  | DEG |  |     |  |
|                                    | E=38.15 | 1/4 Throttle                                                                            |  | DCA |  | DCE |  | DCF |  | DEG |  | DGH |  | DEJ |  | DEK |  | DEL |  | DEM |  | DEN |  | DEQ |  | DEG |  | DEH |  |
|                                    | G=39.95 | LEAN                                                                                    |  | DCA |  | DCE |  | DCF |  | DEG |  | DGH |  | DEJ |  | DEK |  | DEL |  | DEM |  | DEN |  | DEQ |  | DEG |  | DEH |  |
| E<br>2' 00'                        | C=36.35 | RICH                                                                                    |  | EEE |  | EEF |  | EEG |  | EEH |  | EEJ |  | EEK |  | EEL |  | EEM |  | EEN |  | EEQ |  | EEG |  | EEH |  |     |  |
|                                    | E=38.15 | 1/4 Throttle                                                                            |  | EEE |  | EEF |  | EEG |  | EEH |  | EEJ |  | EEK |  | EEL |  | EEM |  | EEN |  | EEQ |  | EEG |  | EEH |  | EEI |  |
|                                    | G=39.95 | LEAN                                                                                    |  | EEG |  | EEF |  | EEG |  | EEH |  | EEJ |  | EEK |  | EEL |  | EEM |  | EEN |  | EEQ |  | EEG |  | EEH |  | EEI |  |

**JET NEEDLES**

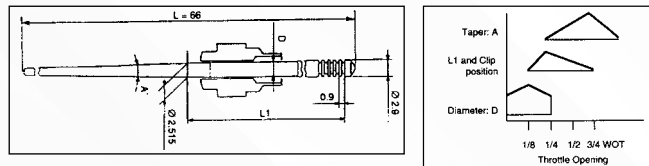

| PART NO. |     | PART NO. |     | PART NO. |     | PART NO. |     |
|----------|-----|----------|-----|----------|-----|----------|-----|
| 915607   | CCG | 915637   | CGH | 915685   | DEN | 915749   | EEJ |
| 915608   | CCH | 915638   | CGJ | 915687   | DEQ | 915750   | EEK |
| 915610   | CCK | 915639   | CGK | 915700   | DGG | 915751   | EEL |
| 915611   | CCL | 915640   | CGL | 915701   | DGH | 915752   | EEM |
| 915612   | CCM | 915641   | CGM | 915702   | DGJ | 915755   | EGE |
| 915613   | CCN | 915642   | CGN | 915703   | DGK | 915766   | EGF |
| 915621   | CEF | 915644   | CGQ | 915704   | DGL | 915767   | EGG |
| 915624   | CEJ | 915649   | DCA | 915705   | DGM | 915768   | EGH |
| 915625   | CEK | 915653   | DCE | 915706   | DGN | 915769   | EGJ |
| 915626   | CEL | 915654   | DCF | 915708   | DGQ | 915770   | EGK |
| 915627   | CEM | 915677   | DEE | 915713   | ECA | 915771   | EGL |
| 915628   | CEN | 915678   | DEF | 915745   | EEE | 915772   | EGM |
| 915630   | CEQ | 915679   | DEG | 915746   | EEF | 915773   | EGN |
| 915635   | CGF | 915681   | DEJ | 915747   | EEG | 915775   | EGQ |
| 915636   | CGG | 915683   | DEL | 915748   | EEH |          |     |

**OEM N427-48XXX  
SERIES CONVERSION CHART**

THE MARK ORDER OF OEM NEEDLE IS NOT THE SAME AS OPTION'S.

| 1) TAPER |        | 2) DIAMETER |        | OEM OPTION |        | 3) L1 |        |
|----------|--------|-------------|--------|------------|--------|-------|--------|
| OEM      | OPTION | OEM         | OPTION | OEM        | OPTION | OEM   | OPTION |
| 11       | B      | 60          | A      | 72         | N      | A     | A      |
| 13       | C      | 61          | B      | 73         | P      | B     | B      |
| 14       | D      | 62          | C      | 74         | Q      | E     | C      |
| 20       | E      | 63          | D      | 75         | R      | F     | D      |
| 22       | F      | 64          | E      | 76         | S      | J     | E      |
| 30       | J      | 65          | F      | 77         | T      | K     | F      |
|          |        | 66          | G      | 78         | U      | N     | G      |
|          |        | 67          | H      | 79         | V      | P     | H      |
|          |        | 68          | J      | 80         | W      | S     | J      |
|          |        | 69          | K      | 81         | X      | T     | K      |
|          |        | 70          | L      | 82         | Y      | W     | L      |
|          |        | 71          | M      | 83         | Z      | Y     | M      |

**KEIHIN CARBURETOR PWK  
35MM SINGLE**



- KEIHIN CARBURETOR PWK 35MM SINGLE - CRB0018
- Compatible for Honda / Suzuki / Kawasaki / Yamaha / KTM Dirt Bike
- 2-stroke 125-250cc applications

914669

**KEIHIN CARBURETOR PWK  
33MM SINGLE**



- KEIHIN CARBURETOR PWK 33MM SINGLE - CRB0069
- The standard for 2T Dirt and ATV carbs.
- 2-stroke 80-175cc applications

914671

**KEIHIN CARBURETOR PJ  
34MM SINGLE**



- KEIHIN CARBURETOR PJ 34MM SINGLE - CRB0017
- KEIHIN PJ SERIES CARBURETOR.
  - \* This carburetor is for the PJ34MM/67R.
  - \* It contains a 152 slow jet, 55 throttle valve, 48CEG jet needle and 6.0 main jet.

914674

**KEIHIN CARBURETOR PWK  
38MM SINGLE**



- KEIHIN CARBURETOR PWK 38MM SINGLE - CRB0019
- The Keihin PWK two stroke carburetor is the dominant carburetor on the factory motocross machines
- Chromed semi-flat (D) throttle valve for excellent response and more flow at high rpm
- Throttle bores sized to give maximum power
- Available in six popular sizes to cover all your horsepower requirements
- Easy jetting
- 2-stroke 125-500cc applications

914675

**KEIHIN CARBURETOR PWK  
35MM SINGLE W/QUAD  
VENT & AIR STRIKER**



- KEIHIN CARBURETOR PWK 35MM SINGLE W/QUAD VENT & AIR STRIKER - CRB0075
- KEIHIN PWK SERIES CARBURETOR.
  - \* Slow jet 48, throttle valve 4.5, jet needle 48-DEK, and main jet 160.
- Universal 2-stroke 80-175cc

914681

**KEIHIN CARBURETOR PWK  
39MM SINGLE**



- KEIHIN CARBURETOR PWK 39MM SINGLE - CRB0020
- Black vinyl coil-wound housing
- Meets or exceeds OEM quality
- Inner nylon sleeve for longer life and smooth operation
- 2-stroke 250-500cc applications

914254

## KEIHIN CARBURETOR PWK 28MM SINGLE W/CHROME SLIDE



- KEIHIN CARBURETOR PWK 28MM SINGLE W/CHROME SLIDE - CRB0007
- The Keihin PWK two stroke carburetor is the dominant carburetor on the factory motocross machines
- Chromed semi-flat (D) throttle valve for excellent response and more flow at high rpm
- Throttle bores sized to give maximum power
- Available in six popular sizes to cover all your horsepower requirements
- Easy jetting with Jetting parts available
- 2-stroke, 80-200cc

**914717**



## KEIHIN AIR ADJUSTING SCREW SPRING

- KEIHIN AIR ADJUSTING SCREW SPRING - CRP00679
- Keihin air adjusting screw spring for PJ 34 36 38 PWK 35 38 39 PWM 38.

**916063**



## KEIHIN FLOAT

- \*no image in the internet

**916026**



## KEIHIN FLOAT BOWL

- \*no image in the internet

| DESCRIPTIONS | PART #        |
|--------------|---------------|
| CRP00644     | <b>916028</b> |
| CRP00646     | <b>916030</b> |



## KEIHIN AIR ADJUSTING SCREW

- KEIHIN AIR ADJUSTING SCREW - CRP00651
- Keihin air adjusting screw for PJ 34 36 38 PWK 35 38 39 PWM 38.

**916035**



## KEIHIN GASKET, TOP

- KEIHIN GASKET, TOP - CRP00674
- KEIHIN PJ Series Mixing Chamber
- Fits: PWK 33-41mm

**916058**



**KEIHIN COLLAR**

- KEIHIN COLLAR - CRP00678
- KEIHIN PJ Series CollarFits: PJ Carbs

**916062**



**KEIHIN JET NEEDLE-CY SERIES, #NCYS**

- \*no image in the internet

**915884**





### MIKUNI FLOAT CHAMBER SCREW



CW20416 1.30 4mm x 16mm  
 26-28mm spigot mount aluminum carbs, 30-34mm small body aluminum carbs and many zinc body OEM carbs. Mikuni # C2=0416.

- Screw.
- Fits TM28.

**916110**

### MIKUNI FUEL PUMP DOUBLE OUTLET



- Is a dual-outlet, high-flow pump designed for applications where multiple carburetors or a high fuel volume is needed. It's pulse-driven, meaning it utilizes engine vacuum to deliver fuel.

**916112**

### MIKUNI FUEL PUMP SINGLE OUTLET



- Same as SPI 07-187-01
- Rectangular fuel pump for single carb
- Flush mounting flow rate of 14 liters per hour

**916111**

### MIKUNI DUAL OUTLET - ROUND - FLUSH MOUNT



- A pump for use when fuel tank is level to or below carburetor.
- Vacuum operated
- Is a round, pulse-operated fuel pump, designed for engines where fuel is supplied to multiple carburetors or other fuel-delivery systems.

**916114**

### MIKUNI FUEL PUMP, DUAL OUTLET - SQUARE



- Dual outlet square flush mounting
- Flow rate of 31 liters per hour
- Quality Construction: Built with durable materials to withstand harsh conditions.
- High Performance: Delivers optimal fuel flow for enhanced engine performance.
- Compact Design: Space-saving square shape suitable for various installations.
- Versatile Application: Compatible with a wide range of engines and vehicles.

**916113**

### MIKUNI FUEL PUMP TRIPLE OUTLET ROUND FLUSH MOUNT



- is a triple-outlet, pulse-driven pump designed for medium to large engines, particularly in motorcycles, ATVs, and watercraft.
- It uses engine vacuum to provide a steady fuel flow, ensuring consistent performance.
- This pump is known for its durability and efficiency, making it a reliable choice for engines requiring high fuel delivery.

916115



### MIKUNI POP-OFF PRESSURE GAUGE 30PSI

- Is a tool used to check and measure the pop-off pressure of a carburetor's needle and seat assembly.
- It is designed to measure pressures up to 30 PSI and is a useful tool for tuning and diagnosing carburetors.
- Color - Black

916116

### MIKUNI SMALL ROUND MAIN JET 165

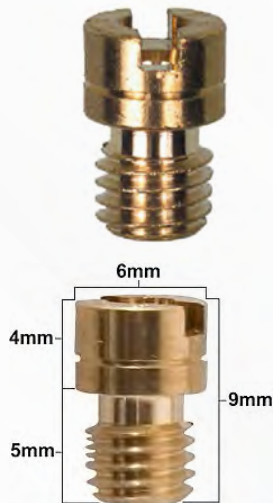

- Precision-made from brass, and used in many original equipment carburetors, including some Mikuni SBN carburetors.
- This jet is part of the Mikuni N102.221 series and has a size of 165.
- It's often sold as a pack of four and is manufactured in Japan.

916117



### MIKUNI NEEDLE VALVE ASSEMBLY

- Compatibility: Designed for use with VM26/26 carburetors
- Material: High-quality materials for durability and longevity
- Performance: Ensures optimal fuel flow for improved engine performance

| SIZES | PART # |
|-------|--------|
| 1.2   | 916118 |
| 2.5   | 916119 |
| 2.8   | 916120 |

### MIKUNI THROTTLE VALVE SPRING



- MIKUNI 26MM - 28MM THROTTLE VALVE SPRING - VM28/257
- THROTTLE VALVE SPRING FOR VM30 CARB - VM34/50
- THROTTLE VALVE SPRING FOR VM32-VM38 CARB - VM34/55

| SIZES     | PART # |
|-----------|--------|
| VM26/VM28 | 916122 |
| VM28/257  | 916121 |
| VM34/50   | 917742 |
| VM34/55   | 917744 |



## MIKUNI CARBURETORS

These carburetors come with cable type choke and 1.5 needle and seat. NOTE: To convert any of these Mikuni Carbs to Lever Type order VMLCK ( 29.30 ) (Genuine).

| SIZES | PART #        |
|-------|---------------|
| 30mm  | <b>916123</b> |
| 32mm  | <b>916124</b> |
| 34mm  | <b>916126</b> |
| 36mm  | <b>916129</b> |
| 38mm  | <b>916138</b> |
| 44mm  | <b>916131</b> |



## MIKUNI STARTER LEVER

- Choke lever assembly for the spigot mounted Mikuni VM36 and VM38.
- Sold individually.

| SIZES       | PART #        |
|-------------|---------------|
| 36mm - 38mm | <b>916125</b> |
| 40mm - 44mm | <b>916135</b> |



## MIKUNI MOUNTING FLANGE FOR CARBURETORS

- Universal mounting flange fits 30-34mm Mikuni carbs

**916127**



## MIKUNI TOP MIXING CHAMBER GASKET

- 30MM - 34MM
- Replacement mixing chamber gasket for VM Carburetor.

**916128**



## MIKUNI TOP MIXING CHAMBER GASKET 36MM - 44MM

- Gasket for VM30 thru 34 Mixing Chamber Top.

**916130**



## MIKUNI SMALL ROUND JET 162.5

- N102.221 Personal Watercraft (High Speed Jets) Super BN 38, BN44, BN46, BN38I, BN40I, BN44I, BN46I

**916133**



## MIKUNI NEEDLE VALVE ASSEMBLY

- Compatibility: Designed for use with VM26/26 carburetors
- Material: High-quality materials for durability and longevity
- Performance: Ensures optimal fuel flow for improved engine performance

| SIZES | PART #        |
|-------|---------------|
| 1.2   | <b>916134</b> |
| 2.5   | <b>916137</b> |



**MIKUNI HOLDING WASHER**

- Float chamber plug gasket for standard VM Style Carburetors

**916231**



**MIKUNI IDLE ADJUSTING SCREW TM**

- Idle Adjusting Screw for 603-16003 Carburetor

**916235**



**MIKUNI HEX MAIN JETS**

| JET SIZES | PART # |
|-----------|--------|
| 50        | 916210 |
| 60        | 916216 |
| 70        | 916223 |
| 80        | 916227 |
| 90        | 916229 |
| 100       | 916157 |
| 110       | 916159 |
| 120       | 916161 |
| 130       | 916163 |
| 140       | 916165 |
| 150       | 916167 |
| 160       | 916169 |
| 170       | 916171 |
| 175       | 916172 |
| 180       | 916173 |
| 185       | 916174 |
| 190       | 916175 |
| 200       | 916177 |
| 210       | 916179 |
| 220       | 916181 |
| 230       | 916182 |
| 240       | 916183 |
| 250       | 916185 |
| 260       | 916186 |
| 270       | 916187 |
| 280       | 916188 |
| 290       | 916189 |
| 300       | 916190 |
| 310       | 916191 |
| 320       | 916192 |
| 330       | 916193 |
| 340       | 916194 |



| JET SIZE | PART NO. |
|----------|----------|
| 350      | 916195   |
| 360      | 916196   |
| 370      | 916197   |
| 380      | 916198   |
| 390      | 916199   |
| 400      | 916200   |
| 410      | 916201   |
| 420      | 916202   |
| 430      | 916203   |
| 440      | 916204   |
| 450      | 916205   |
| 460      | 916206   |
| 470      | 916207   |
| 480      | 916208   |
| 490      | 916209   |
| 500      | 916211   |
| 540      | 916212   |
| 560      | 916214   |
| 580      | 916215   |
| 600      | 916217   |
| 620      | 916218   |
| 640      | 916219   |
| 660      | 916221   |
| 680      | 916222   |
| 700      | 916224   |
| 720      | 916225   |



**MIKUNI FLAT SLIDE IDLE ADJUSTER SCREW TM28**

- Idle adjustment screw for the Mikuni 28mm flat slide carbs.

**916237**



**MIKUNI IDLE ADJUSTER**

- Idle Adjuster for TM36 and TM38 carbs
- Not Applicable for TM28 thru TM34

**916239**



## MIKUNI ADJUSTER

- Super BN Carburetor (#24) (#26)
- Designed for use with Mikuni Super BN, SBN, and BN461 carburetors.



| DESCRIPTIONS        | PART #        |
|---------------------|---------------|
| High Speed Adjuster | <b>916241</b> |
| Low Speed Adjuster  | <b>916243</b> |



## MIKUNI NEEDLE VALVE ASSEMBLY

- Needle Valve Arm Spring used in carburetors.

| GRAMS    | COLORS       | SIZES  | PART #        |
|----------|--------------|--------|---------------|
| 95 GRAMS | DULL SILVER  | 15.7MM | <b>916279</b> |
| 65 GRAMS | SHINY SILVER | 14.6MM | <b>916280</b> |
| 80 GRAMS | BLACK        | 14.6MM | <b>916282</b> |

## MIKUNI THROTTLE VALVE SPRING

A Mikuni throttle valve spring is a coiled spring, typically made of steel, that provides tension to the throttle valve within a Mikuni carburetor. It's designed to return the throttle valve to its closed position after the throttle is released and to maintain the valve's proper position under varying engine loads.



| DESCRIPTIONS | PART #        |
|--------------|---------------|
| TH           | <b>916289</b> |
| TH VALV      | <b>916291</b> |



## MIKUNI TOP, MIXING CHAMBER

- MIKUNI TM Mixing Chamber Top for TM36 and TM38 Not Applicable to TM28 thru TM34



**916296**

## NEEDLE VALVE ASSEMBLY



**786-15005**

| JET SIZES | PART #        |
|-----------|---------------|
| 1.5       | <b>916363</b> |
| 2.0       | <b>916364</b> |
| 2.5       | <b>916365</b> |

**786-35015**

| JET SIZES | PART #        |
|-----------|---------------|
| 1.5       | <b>916371</b> |
| 1.8       | <b>916372</b> |
| 2.0       | <b>916373</b> |
| 2.3       | <b>916374</b> |
| 2.5       | <b>916375</b> |

**786-35018**

| JET SIZES | PART #        |
|-----------|---------------|
| 1.5       | <b>916377</b> |
| 1.8       | <b>916378</b> |
| 2.0       | <b>916379</b> |
| 2.5       | <b>916381</b> |

**786-46001**

| JET SIZES | PART #        |
|-----------|---------------|
| 1.5       | <b>916391</b> |
| 1.8       | <b>916392</b> |
| 2.0       | <b>916393</b> |
| 3.0       | <b>916394</b> |
| 3.3       | <b>916395</b> |
| 3.5       | <b>916396</b> |

**MIKUNI NEEDLE JET**



| JET SIZES | JET SERIES | PART #        |
|-----------|------------|---------------|
| O-4       | 480        | <b>916312</b> |
| P-2       | 480        | <b>916327</b> |
| Q-0       | 480        | <b>916334</b> |
| Q-4       | 480        | <b>916338</b> |
| Q-6       | 480        | <b>916340</b> |

| JET SIZES | JET SERIES | PART #        |
|-----------|------------|---------------|
| O-0       | 389        | <b>916344</b> |
| O-2       | 389        | <b>916345</b> |
| O-4       | 389        | <b>916346</b> |
| O-8       | 389        | <b>916348</b> |
| P-0       | 389        | <b>916349</b> |
| P-2       | 389        | <b>916350</b> |
| P-4       | 389        | <b>916351</b> |
| P-6       | 389        | <b>916352</b> |
| P-8       | 389        | <b>916353</b> |
| Q-2       | 389        | <b>916355</b> |
| Q-4       | 389        | <b>916356</b> |
| R-4       | 389        | <b>916361</b> |

| JET SIZES | JET SERIES | PART #        |
|-----------|------------|---------------|
| P-0       | 166        | <b>916410</b> |
| P-2       | 166        | <b>916411</b> |
| P-4       | 166        | <b>916412</b> |
| P-5       | 166        | <b>916413</b> |
| Q-0       | 166        | <b>916416</b> |
| Q-4       | 166        | <b>916418</b> |
| Q-8       | 166        | <b>916421</b> |
| R-0       | 166        | <b>916422</b> |
| R-2       | 166        | <b>916423</b> |
| R-4       | 166        | <b>916424</b> |
| R-6       | 166        | <b>916425</b> |
| R-8       | 166        | <b>916426</b> |

| JET SIZES | JET SERIES | PART #        |
|-----------|------------|---------------|
| P-4       | 159        | <b>916429</b> |
| P-5       | 159        | <b>916430</b> |
| Q-8       | 159        | <b>916438</b> |
| R-2       | 159        | <b>916440</b> |
| R-4       | 159        | <b>916441</b> |
| R-5       | 159        | <b>916442</b> |
| R-6       | 159        | <b>916443</b> |
| R-8       | 159        | <b>916444</b> |

**MIKUNI AMERICAN VALVE**



- BN34/107
- Check Valve for Super BN Carburetor

**916505**

**MIKUNI ADJUSTING LOCKNUT**



- Adjusting Locknut - B30/247
- Cable adjuster locknut for Standard VM Style Carburetors

**916457**

**MIKUNI PUMP COVER**



- Suits Mikuni Super BN38, BN44, and BN46 and also BN381, BN401 Square Pump Styles.
- Is a replacement part for Mikuni carburetors, specifically designed to protect the fuel pump module.

| COLORS | PART #        |
|--------|---------------|
| BLACK  | <b>916448</b> |
| GOLD   | <b>916449</b> |

## MIKUNI SPRINGS

### MIKUNI SCREW



- Mikuni - Screw - BN34/120-30
- Screw with Washer for Super BN Carburetor

**916507**



- Idle Spring for Super BN Carburetor BN38/341
- Low Speed Spring for BN Carburetor BN38/343
- Spring for Super BN Carburetor BN38/344

| DESCRIPTIONS       | PART #        |
|--------------------|---------------|
| Spring - BN38/341  | <b>916512</b> |
| Lo-spnd - BN38/343 | <b>916513</b> |
| Hi-spnd - BN38/344 | <b>916514</b> |

## PILOT JETS



- Mikuni # VM22/210
- Used in most Mikuni Carburetors
- Sold each

### VM22-210

| JET SIZES | PART #        |
|-----------|---------------|
| 10        | <b>917475</b> |
| 12.5      | <b>917478</b> |
| 17.5      | <b>917482</b> |
| 20        | <b>917483</b> |
| 25        | <b>917485</b> |
| 30        | <b>917487</b> |
| 35        | <b>917489</b> |
| 37.5      | <b>917490</b> |
| 40        | <b>917491</b> |
| 42.5      | <b>917492</b> |
| 45        | <b>917493</b> |
| 47.5      | <b>917494</b> |
| 50        | <b>917495</b> |
| 55        | <b>917497</b> |
| 60        | <b>917499</b> |
| 70        | <b>917501</b> |



- Mikuni # VM28/486
- Fits all RS and HS carburetors and late model Suzuki RM/25/25

| JET SIZES | PART #        |
|-----------|---------------|
| 15        | <b>917596</b> |
| 17.5      | <b>917597</b> |
| 20        | <b>917598</b> |
| 25        | <b>917600</b> |
| 30        | <b>917602</b> |
| 35        | <b>917604</b> |
| 40        | <b>917606</b> |
| 45        | <b>917608</b> |
| 50        | <b>917610</b> |
| 55        | <b>917612</b> |
| 60        | <b>917614</b> |



- Mikuni # N224.103
- OEM for Yamaha Y2, new TMX, BDST

| JET SIZES | PART #        |
|-----------|---------------|
| 20        | <b>917244</b> |
| 22.5      | <b>917245</b> |
| 25        | <b>917246</b> |
| 27.5      | <b>917247</b> |
| 30        | <b>917248</b> |
| 32.5      | <b>917249</b> |
| 35        | <b>917250</b> |
| 37.5      | <b>917251</b> |
| 40        | <b>917252</b> |
| 45        | <b>917254</b> |
| 50        | <b>917256</b> |
| 60        | <b>917260</b> |
| 65        | <b>917261</b> |



- Mikuni # BS30/96
- Bleed type

| JET SIZES | PART #        |
|-----------|---------------|
| 30        | <b>916537</b> |
| 35        | <b>916539</b> |
| 37.5      | <b>916540</b> |
| 40        | <b>916541</b> |
| 42.5      | <b>916542</b> |
| 45        | <b>916543</b> |
| 47.5      | <b>916544</b> |
| 50        | <b>916545</b> |
| 52.5      | <b>916546</b> |
| 55        | <b>916547</b> |
| 57.5      | <b>916548</b> |
| 60        | <b>916549</b> |

## AIR JETS



### VM28-1001

| JET SIZES | PART #        |
|-----------|---------------|
| 20        | <b>916840</b> |
| 25        | <b>916842</b> |
| 30        | <b>916844</b> |
| 35        | <b>916846</b> |
| 40        | <b>916848</b> |
| 45        | <b>916850</b> |

| JET SIZES | PART #        |
|-----------|---------------|
| 0.5       | <b>916551</b> |
| 0.7       | <b>916553</b> |
| 1.0       | <b>916556</b> |
| 1.2       | <b>916558</b> |
| 1.5       | <b>916561</b> |
| 1.7       | <b>916563</b> |
| 2.0       | <b>916566</b> |



- Mikuni # BS30/97
- Sold each

**JET NEEDLES**

| 26-38 SPIGOT  | 40-44 SPIGOT  | TMX38 FLAT SLIDE | TM36,38 FLAT SLIDE |
|---------------|---------------|------------------|--------------------|
| <b>PART #</b> | <b>PART #</b> | <b>PART #</b>    | <b>PART #</b>      |
| 916648        | 916760        | 916721           | 916746             |
| 916649        | 916766        | 916722           | 916747             |
| 916655        | 916767        | 916723           | 916753             |
| 916662        |               | 916724           |                    |
| 916706        |               | 916725           |                    |
| 916707        |               | 916726           |                    |
| 916708        |               | 916727           |                    |
| 916709        |               | 916728           |                    |
| 916710        |               |                  |                    |
| 916716        |               |                  |                    |
| 916717        |               |                  |                    |
| 916719        |               |                  |                    |
| 916736        |               |                  |                    |
| 916737        |               |                  |                    |
| 916738        |               |                  |                    |
| 916739        |               |                  |                    |
| 916741        |               |                  |                    |
| 916745        |               |                  |                    |
| 916758        |               |                  |                    |
| 916759        |               |                  |                    |



The Jet Needle controls the fuel mixture in the mid-range 1/4-3/4 throttle position. The taper of the needle determines the amount of the fuel. For example: the thinner the diameter of the needle, the more fuel will be drawn. The thicker the diameter of the needle, the less fuel can be drawn.



**MIKUNI FUEL PUMP**

- DF62-702
- DF-62 pumps 65 liters per hour
- A pump for use when fuel tank is level to or below carburetor.
- Vacuum operated

916617



**MIKUNI NEEDLE VALVE O-RING**

- Mikuni - O-ring - KV/10
- MIKUNI TM CARBURETOR O-Ring Fits TM32,34,36,38

916817



## MIKUNI JET NEEDLE E-RING



- Crafted from the highest-grade materials
- Jet needle retaining E clip
- Sold each

**916567**

## MIKUNI NEEDLE JET SETTER O-RING



- A type of gasket, typically a circular loop of elastomer, used to create a seal.
- Sold each

**916578**

## MIKUNI SCREW



- Mikuni - Screw - C2=0406
- MIKUNI TM Screw for Needle and Seat Retainer Fits TM32, TM34, TM36, TM48.

**916583**

## MIKUNI FLOAT BOWL SCREWS



- 5mm x 18mm float bowl screw
- They are made from steel and have a gold iridited coating.
- sold in packs of 10.

**916590**

## MIKUNI SCREW - C6=0308G



- Mikuni - Screw - C6=0308-K
- Screw for Carburetor

**916597**

## MIKUNI SCREWS



- MIKUNI TM CARBURETOR Screw with Lockwasher. Fits All TM Series.

| SIZES    | PART #        |
|----------|---------------|
| CW2=0412 | <b>916603</b> |
| CW2=0516 | <b>916609</b> |

## SMALL HEX MAIN JETS

- Mikuni # M10/14
- Small hex type used in Mikuni carburetors



| JET SIZES | PART #        |
|-----------|---------------|
| 110       | <b>916820</b> |
| 125       | <b>916823</b> |
| 140       | <b>916826</b> |
| 155       | <b>916827</b> |
| 160       | <b>916828</b> |
| 180       | <b>916831</b> |
| 200       | <b>916832</b> |

## LARGE ROUND MAIN JETS

- Mikuni # N100/604
- Large round type
- Sold each



## HEX MAIN JETS

- Mikuni # N100/606
- Mikuni Low Speed Pilot Jets
- Used in most Mikuni carburetors
- Fuel flow grams/min.



### POLARIS OEM EQUIVALENT

For Reference Only

540 = 510N      650 = 540N  
 560 = 520N      660 = 550N  
 600 = 530N      700 = 560N

| JET SIZES | PART #        |
|-----------|---------------|
| 30        | <b>916973</b> |
| 32.5      | <b>916974</b> |
| 37.5      | <b>916975</b> |
| 40        | <b>916976</b> |
| 42.5      | <b>916977</b> |
| 45        | <b>916978</b> |
| 47.5      | <b>916979</b> |
| 50        | <b>916980</b> |
| 52.5      | <b>916981</b> |
| 55        | <b>916982</b> |
| 57.5      | <b>916983</b> |
| 60        | <b>916984</b> |
| 62.5      | <b>916985</b> |
| 65        | <b>916986</b> |
| 67.5      | <b>916987</b> |
| 70        | <b>916988</b> |
| 72.5      | <b>916989</b> |
| 75        | <b>916990</b> |
| 77.5      | <b>916991</b> |
| 80        | <b>916992</b> |
| 82.5      | <b>916993</b> |
| 85        | <b>916994</b> |
| 87.5      | <b>916995</b> |
| 90        | <b>916996</b> |
| 92.5      | <b>916997</b> |
| 95        | <b>916998</b> |
| 97.5      | <b>916999</b> |

| JET SIZES | PART #        |
|-----------|---------------|
| 100       | <b>916950</b> |
| 102.5     | <b>916951</b> |
| 105       | <b>916952</b> |
| 107.5     | <b>916953</b> |
| 110       | <b>916954</b> |
| 112.5     | <b>916955</b> |
| 115       | <b>916956</b> |
| 117.5     | <b>916957</b> |
| 120       | <b>916958</b> |
| 122.5     | <b>916959</b> |
| 125       | <b>916960</b> |
| 127.5     | <b>916961</b> |
| 130       | <b>916962</b> |
| 132.5     | <b>916963</b> |
| 135       | <b>916964</b> |
| 137.5     | <b>916965</b> |
| 140       | <b>916966</b> |
| 142.5     | <b>916967</b> |
| 145       | <b>916968</b> |
| 147.5     | <b>916969</b> |
| 150       | <b>916970</b> |
| 155       | <b>916971</b> |
| 160       | <b>916972</b> |

| JET SIZES | PART #        |
|-----------|---------------|
| 50        | <b>916930</b> |
| 55        | <b>916932</b> |
| 60        | <b>916934</b> |
| 65        | <b>916936</b> |
| 70        | <b>916938</b> |
| 75        | <b>916940</b> |
| 80        | <b>916942</b> |
| 85        | <b>916944</b> |
| 90        | <b>916946</b> |
| 95        | <b>916948</b> |
| 100       | <b>916884</b> |
| 102.5     | <b>916885</b> |
| 105       | <b>916886</b> |
| 107.5     | <b>916887</b> |
| 110       | <b>916888</b> |
| 112.5     | <b>916889</b> |
| 115       | <b>916890</b> |
| 117.5     | <b>916891</b> |
| 120       | <b>916892</b> |
| 122.5     | <b>916893</b> |
| 125       | <b>916894</b> |

| JET SIZES | PART #        |
|-----------|---------------|
| 127.5     | <b>916895</b> |
| 130       | <b>916896</b> |
| 132.5     | <b>916897</b> |
| 135       | <b>916898</b> |
| 137.5     | <b>916899</b> |
| 140       | <b>916900</b> |
| 145       | <b>916902</b> |
| 150       | <b>916904</b> |
| 155       | <b>916906</b> |
| 160       | <b>916908</b> |
| 165       | <b>916910</b> |
| 170       | <b>916912</b> |
| 175       | <b>916914</b> |
| 180       | <b>916916</b> |
| 185       | <b>916918</b> |
| 190       | <b>916920</b> |
| 195       | <b>916922</b> |
| 200       | <b>916923</b> |
| 205       | <b>916924</b> |
| 210       | <b>916925</b> |

## SMALL ROUND MAIN JETS

- Mikuni # N102/221
- Small round type
- Sold each



| JET SIZES | PART #        |
|-----------|---------------|
| 30        | <b>917081</b> |
| 35        | <b>917082</b> |
| 40        | <b>917083</b> |
| 42.5      | <b>917084</b> |
| 45        | <b>917085</b> |
| 47.5      | <b>917086</b> |
| 50        | <b>917087</b> |
| 52.5      | <b>917088</b> |
| 55        | <b>917089</b> |
| 57.5      | <b>917090</b> |
| 60        | <b>917091</b> |
| 62.5      | <b>917092</b> |
| 65        | <b>917093</b> |
| 67.5      | <b>917094</b> |
| 70        | <b>917095</b> |
| 72.5      | <b>917096</b> |
| 75        | <b>917097</b> |
| 77.5      | <b>917098</b> |
| 80        | <b>917099</b> |
| 82.5      | <b>917100</b> |
| 85        | <b>917101</b> |
| 87.5      | <b>917102</b> |
| 90        | <b>917103</b> |
| 92.5      | <b>917104</b> |
| 95        | <b>917105</b> |
| 97.5      | <b>917106</b> |
| 100       | <b>917037</b> |
| 102.5     | <b>917038</b> |
| 105       | <b>917039</b> |
| 107.5     | <b>917040</b> |
| 110       | <b>917041</b> |
| 112.5     | <b>917042</b> |
| 115       | <b>917043</b> |
| 117.5     | <b>917044</b> |

| JET SIZES | PART #        |
|-----------|---------------|
| 120       | <b>917045</b> |
| 122.5     | <b>917046</b> |
| 125       | <b>917047</b> |
| 127.5     | <b>917048</b> |
| 130       | <b>917049</b> |
| 132.5     | <b>917050</b> |
| 135       | <b>917051</b> |
| 137.5     | <b>917052</b> |
| 140       | <b>917053</b> |
| 142.5     | <b>917054</b> |
| 145       | <b>917055</b> |
| 147.5     | <b>917056</b> |
| 150       | <b>917057</b> |
| 152.5     | <b>917058</b> |
| 155       | <b>917059</b> |
| 157.5     | <b>917060</b> |
| 160       | <b>917061</b> |
| 167.5     | <b>917062</b> |
| 170       | <b>917063</b> |
| 172.5     | <b>917064</b> |
| 175       | <b>917065</b> |
| 177.5     | <b>917066</b> |
| 180       | <b>917067</b> |
| 182.5     | <b>917068</b> |
| 185       | <b>917069</b> |
| 190       | <b>917071</b> |
| 195       | <b>917072</b> |
| 200       | <b>917073</b> |
| 205       | <b>917074</b> |
| 210       | <b>917075</b> |
| 215       | <b>917076</b> |
| 220       | <b>917077</b> |
| 230       | <b>917078</b> |
| 240       | <b>917079</b> |



## MIKUNI POCKET TUNER

This pocket size calculator can be used to determine required jetting changes in carburetors due to changes in temperature and altitude.

**916857**



## MIKUNI PWC PARTS KIT

- Throttle Shaft Rebuild Kit
- Kit includes butterfly valve, shaft seals, screws and instructions.

| DESCRIPTIONS | PART #        |
|--------------|---------------|
| MK-BN/038 TV | <b>916861</b> |
| MK-BN/044 TV | <b>916862</b> |



## POP OFF PUMP GAUGE

- Mikuni - MK-BN PMP-100
- Pop Off Pump Gauge, 100PSI
- Check needle and seat holding pressure, crankshaft seals, crankcase surfaces, and many other critical parts with this simple tool.

**916868**



**MIKUNI PULSE PUMP REBUILD KIT**

- REBUILD KIT DF44
- This kit includes: 4x Screws, 1x Gasket, 1x Diaphragm, 1x Membrane

**916876**



**MIKUNI PULSE PUMP REBUILD KIT**

- REBUILD KIT DF52
- This kit includes: 4x Gaskets, 2x Diaphragms, 2x Valves, 2x Grommets

**916877**



**MIKUNI O-RING**

- Mikuni - O-ring - N133037
- MIKUNI TM Series Pilot Air Screw O-Ring Fits TM Series Not Applicable for TM38

**917157**



**MIKUNI THROTTLE BELL LEVER CRANK PIN**

- HSR TM36/40 RS
- Genuine Mikuni throttle lever pin. Fits TM36-68, TM40-06, and all HSR, and RS series carburetors.

**917167**



**MIKUNI NUT**

- Mikuni - Nut- N2-04
- This term probably refers to a specific type of nut used in Mikuni carburetors, potentially related to the main jet installation or the float bowl.

**917215**



**MIKUNI FUEL SCREW WASHER**

Refers to a specific washer size or type within the Mikuni VM carburetor series.

| DESCRIPTIONS | PART #        |
|--------------|---------------|
| VM12/33      | <b>917413</b> |
| VM14/87      | <b>917421</b> |

## TM SERIES CARBURETOR

| CARB. DESCRIPTION | MAIN JET  | PILOT JET     | NEEDLE JET | JET NEEDLE | THROTTLE VALVE  | AIR JET | PART #        |
|-------------------|-----------|---------------|------------|------------|-----------------|---------|---------------|
| TM24-8001         | 4/042 130 | VM22/210 15   | 454 Q-0    | 5N13       | 832-30006 3.0   | .6      | <b>917279</b> |
| TM32-1            | 4/042 250 | VM22/210 45   | 389 Q-2    | 5FP17      | 832-39012 4.0   | NONE    | <b>917292</b> |
| TM34-2            | 4/042 280 | VM22/210 50   | 389 Q-2    | 5FP17      | 832-39012 4.0   | NONE    | <b>917300</b> |
| TM35-1            | 4/042 350 | VM22/210 20   | FIXED      | 6EN11-53   | 999-832-014 6.0 | NONE    | <b>917301</b> |
| TM38-18           | 4/042 370 | VM22/210 20   | FIXED      | 6EJ12-55   | 999-832-014 3.5 | 1.7     | <b>917331</b> |
| TM38-85/47mm*     | 4/042 230 | VM22/210 22.5 | 389 Q-2    | 6FJ41      | 832-43011 4.0   | NONE    | <b>917333</b> |
| TM38-86/43mm*     | 4/042 230 | M22/210 22.5  | 389 Q-2    | 6FJ41      | 832-43011 4.0   | NONE    | <b>917334</b> |

\* SPIGOT O.D.



### TMX35/38MM CARBURETORS FOR DIRT BIKES AND ATV SERIES CARBURETOR

#### STANDARD SETTINGS

| Carb No. | Main Jet  | Pilot Jet   | Jet Needle | Throttle Valve  | PART #   |        |
|----------|-----------|-------------|------------|-----------------|----------|--------|
| TMX35-1  | 4/042 350 | VM22/210 20 | 6EN11-53   | 999-832-014-6.0 | TMX35-1  | 215.95 |
| TMX38-18 | 370       | 20          | 6EJ12-55   | 999-832-014-3.5 | TMX38-18 | 197.70 |



The TMX features a flat slide design in a smooth bore Venturi to provide improved throttle response and wider powerband. The float system with independently moving floats, working with a main jet enclosed in a baffle chamber, allows the TMX to perform smoothly without hesitation on the roughest terrain. TMX Series Carburetors are available in 35mm bore sizes for 125cc race engines, and in 38mm bore sizes for use in 250cc race engines.

Mikuni TMX Series Carburetors are intended for off-road riding and racing use only. Not legal for sale or use in California or other locations where similar pollution laws may apply.

### TYPICAL EXPLODED VIEW TM FLAT SLIDE CARBURETOR

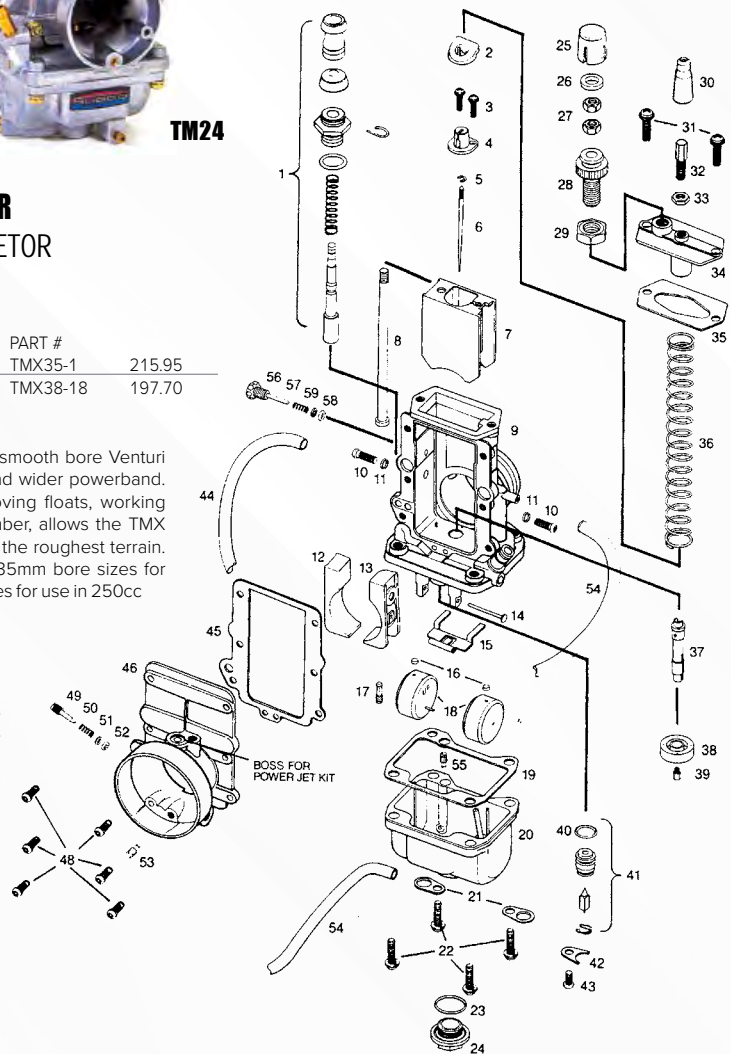



**MIKUNI O RING**

- Mikuni - O Ring - VM14/75
- MIKUNI TM Carburetor O-Ring Fits TM24 and TM28

**917420**



**MIKUNI STARTER PLUNGER**

- Mikuni - Starter Plunger - VM18/144
- Starting system plunger for standard VM style Carburetor.

**917447**



**MIKUNI SPRING**

- Mikuni - Sprng - VM15/112

**917426**



**MIKUNI AIR ADJUSTING SCREW**

- Mikuni Air Adjusting Screw- VM20/214
- Air adjusting screw for VM Style Carburetors

**917461**



**MIKUNI RUBBER CAP**

- MIKUNI TM Carburetor Rubber Cap Fits TM32 thru TM38 - VM18/228
- MIKUNI TM Carburetor Rubber Cap Fits TM28 - VM26/46

| DESCRIPTIONS | PART #        |
|--------------|---------------|
| VM18/228     | <b>917452</b> |
| VM26/46      | <b>917548</b> |





**MIKUNI E-RING**

- Vm20/369 E-Ring, for Needles with an outside diameter of 2.5mm at the C-clip groove section
- Sold each

**917464**



**MIKUNI STARTER PLUNGER RUBBER CAP**

- VM20/455
- Starter Plunger Rubber Cap, VM26 thru VM44 Carb
- Sold Each

**917465**



**MIKUNI CAP**

- Mikuni - Cap - VM20/456
- Starting system plunger fitting for standard VM Style Carburetor

**917466**



**MIKUNI FLAT SLIDE PILOT AIR SCREW ADJUSTER**

- Mikuni Air Screw, Pilot Adjustment TM28 VM28/584
- Flat Slide Pilot Air Screw Adjuster

**917470**



**MIKUNI IDLE ADJUSTING SCREW**

- Idle Adjusting Screw for VM36 & VM38 Carburetor - VM22/171
- Idle Adjusting Screw for VM30 Carburetor - VM28/142

| SIZES    | PART #        |
|----------|---------------|
| VM22/171 | <b>917474</b> |
| VM28/142 | <b>917567</b> |



**MIKUNI THROTTLE STOP SCREWS**

- Mikuni - VM24/224
- Idle Adjusting Screw for VM32 & VM34 Carburetor

**917513**



**MIKUNI FLOAT**

- Mikuni - Float - VM24/236
- MIKUNI TM Carburetor Replacement Float Fits TM32,34,36,38

**917514**

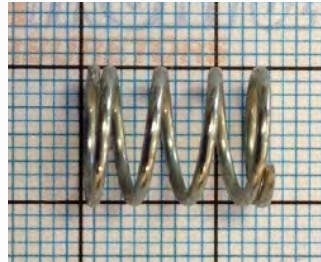

**MIKUNI SPRING**

- Throttle Stop Screw Spring (VM24/556)

**917517**



**MIKUNI NEEDLE VALVE**

- VM24/557-2.5
- Needle and Seat Valves for Square Pump, 2.5
- Super BN (Push in) Viton Tip

**917520**



**MIKUNI O-RING**

- Mikuni - O-ring - VM24/559
- O-ring for TM28 carburetors
- 6.70mm x 1.35mm

**917521**



**MIKUNI PLATE**

- Mikuni - Plate - VM24/560
- MIKUNI TM Carburetor Needle Valve Plate Fits All TM Series

**917522**



**MIKUNI AIR SCREW**

- Mikuni - Air Screw Tm38 - VM24/622
- MIKUNI TM Carburetor Pilot Air Screw Fits TM32,34,36,38

**917523**



## MIKUNI WASHER

- Mikuni - VM26/124
- Mikuni Replacement Banjo bolt washer Fits Standard VM Style Carburetor

**917529**



## MIKUNI NEEDLE VALVE ASSEMBLY

- Genuine Mikuni VM26/185-1.5 Float Valve Assembly

**917532**



## MIKUNI O-RING

- Mikuni - O-ring - VM26/227
- MIKUNI TM Carburetor O-Ring Fits TM28

**917534**



## MIKUNI NEEDLE VALVE WASHER

- Mikuni Needle Valve Washer - VM26/25
- Genuine Mikuni washer for thread in needle & seat assemblies.

**917536**



## MIKUNI NEEDLE VALVE ASSEMBLY



**VM26/26**

| JET SIZES | PART #        |
|-----------|---------------|
| 1.5       | <b>917539</b> |
| 1.8       | <b>917540</b> |
| 2.0       | <b>917541</b> |
| 2.3       | <b>917542</b> |

**VM28/163**

| JET SIZES | PART #        |
|-----------|---------------|
| 1.5       | <b>917568</b> |
| 1.8       | <b>917569</b> |
| 2.0       | <b>917570</b> |
| 3.0       | <b>917571</b> |

**VM28/511**

| JET SIZES | PART #        |
|-----------|---------------|
| 1.5       | <b>917619</b> |
| 1.8       | <b>917620</b> |
| 2.0       | <b>917621</b> |
| 2.5       | <b>917622</b> |



**MIKUNI MIXING CHAMBER TOP**

- Mikuni - VM26/56
- Top Mixing Chamber for VM26 & VM28 Carb

917553



**MIKUNI CARBURETOR MC**

- Mikuni - VM26-606
- Round Slide VM Series Carburetor - 26mm

917556

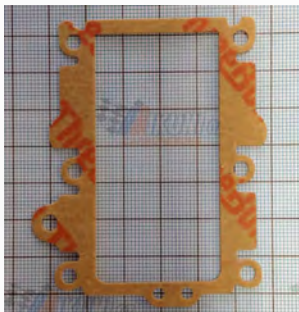

**MIKUNI FRONT FACE TM28**

- Mikuni - VM28/1044
- Mikuni TM24, TM28 (VM28-418) front body cover gasket

917559



**MIKUNI GASKET TOP COVER**

- Mikuni - VM28/1045
- Genuine Mikuni top cover gasket for the flat slide TM28 (VM28-418) carburetors.

917560



**MIKUNI STARTER LEVER**

- Mikuni - VM28/124
- Starter control lever for VM30 thru 34.

917562

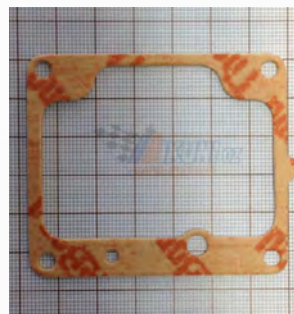

**MIKUNI FLOAT BOWL GASKET**

- Mikuni - Gasket - VM28/129
- MIKUNI FLOAT BOWL GASKET Fits carbs 26-28 Replaces Kawasaki 11009-3508 and Ski Doo 404-1179-00

917563



## MIKUNI PLATE

- Mikuni Spring Seat Plate - VM28/132
- Mikuni Needle Retainer Plate Fits VM Style Carburetors

**917564**



## MIKUNI FLOAT BOWL DRAIN PLUG

- Float Bowl Drain Plug, 26, 28, 40 and 44mm Spigot - VM28/133
- Float Bowl Drain Plug, 36mm Spigot - VM28/253
- Replacement float bowl drain plug for the flat slide VM28-418(TM28) - VM28/817

| SIZES    | PART #        |
|----------|---------------|
| VM28/133 | <b>917565</b> |
| VM28/253 | <b>917585</b> |
| VM28/817 | <b>917632</b> |

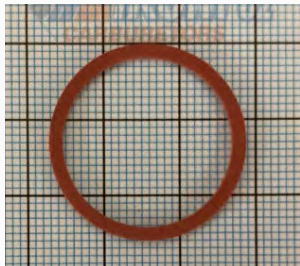

## MIKUNI WASHER PLUG

- Mikuni - Washer Plug - VM28/134
- Washer Plug for VM26,28,40 and 44 Carburetor

**917566**



## MIKUNI FLOATS

- Mikuni Float - VM28/164
- Float for 36-44mm Carburetors

**917572**

## MIKUNI FLOAT ARM



- Float arm hinge for VM26,VM28 and VM30 SMALL BODY spigot mounted carbs - VM28/166
- REPLACEMENT PART FOR STD VM STYLE CARBURETOR. \*Float arm - VM28/59
- Float Arm, 36 thru 44mm Spigot, 36-38mm Flatslide - VM36/15

| SIZES    | PART #        |
|----------|---------------|
| VM28/166 | <b>917573</b> |
| VM28/59  | <b>917629</b> |
| VM36/15  | <b>917755</b> |



## MIKUNI MAIN JET RING

- Main Jet Ring - VM26,VM28,VM40 and VM44 - VM28/228
- Main Jet Ring for TM Carbs Fits TM32,34,36,38 - VM34/454

| SIZES    | PART #        |
|----------|---------------|
| VM28/228 | <b>917584</b> |
| VM34/454 | <b>917741</b> |



**MIKUNI MAIN JET O-RING**

- MIKUNI Main Jet O-Ring - VM28/254
- Main Jet Plug O-Ring for 29mm Smoothbore

917586



**MIKUNI NEEDLE JET SETTER**

- Mikuni Needle Jet Setter - VM28/53
- Needle Jet Setter, 26 thru 34mm Flange

917623



**MIKUNI VENT TUBE ANCHOR PLATE**

- Mikuni - Set Plate - VM28/79
- Vent tube retaining plate for VM Carburetors

917631



**MIKUNI TM SERIES FLAT SLIDE CARBURETOR**

- Mikuni TM Series Flat Slide Carburetor (VM28-418), 28mm

917640



**MIKUNI SMOOTHBORE NEEDLE JET**

- VM29/16 P-0
- Genuine Mikuni needle jet for the discontinued VM29 and VM33 Mikuni Smoothbore carburetors.

917645



**MIKUNI AMERICAN STARTER PLUNGER**

- MikuniLever Choke Kit
- Choke Assembly, VM29/47, TM32, 34, 36, 38
- Kit converts cable operated chokes to Plunger operation

917646







## MIKUNI PIN FLOAT

VM30/160 Pin, for float assembly. This item fits the version of these carburetors sold on this site but may not match those on many similar but slightly different versions of the same size carburetors made specially by the Mikuni factory for OEM motorcycle manufacturers. The Mikunioz back board with 1 and 10mm increments may help you with identification but if it doesn't match up, it wont and if in doubt please call our office before ordering.

**917648**

## MIKUNI NEEDLE JET • PRIMARY TYPE

The needle jet is the main fuel passage to the main bore of the Mikuni carburetor. Depending on the inside diameter of a specific needle jet, this will also affect the function of the needle. Therefore, needle jets and needles act together as the main system in controlling the amount and mixture of the fuel which is drawn in mid-range 1/4-3/4 throttle operation.

|                                                                                                                                                                                                                        |  |  |  |  |     |               |     |               |     |               |                                                                                                                                                                                                                                                                                                                                                                                                                                                      |           |        |     |               |     |               |     |               |     |               |     |               |     |               |     |               |                                                                                                                                                                                                                                                                                                         |           |        |     |               |     |               |     |               |     |               |                                                                                                                                                                                                                                                                                                                                                                                                       |           |        |     |               |     |               |     |               |     |               |     |               |     |               |                                                                                                                                                                                                                                                                                                         |           |        |     |               |     |               |     |               |     |               |
|---------------------------------------------------------------------------------------------------------------------------------------------------------------------------------------------------------------------------------------------------------------------------------------------------------|-----------------------------------------------------------------------------------|-----------------------------------------------------------------------------------|------------------------------------------------------------------------------------|-------------------------------------------------------------------------------------|-----|---------------|-----|---------------|-----|---------------|------------------------------------------------------------------------------------------------------------------------------------------------------------------------------------------------------------------------------------------------------------------------------------------------------------------------------------------------------------------------------------------------------------------------------------------------------|-----------|--------|-----|---------------|-----|---------------|-----|---------------|-----|---------------|-----|---------------|-----|---------------|-----|---------------|---------------------------------------------------------------------------------------------------------------------------------------------------------------------------------------------------------------------------------------------------------------------------------------------------------|-----------|--------|-----|---------------|-----|---------------|-----|---------------|-----|---------------|-------------------------------------------------------------------------------------------------------------------------------------------------------------------------------------------------------------------------------------------------------------------------------------------------------------------------------------------------------------------------------------------------------|-----------|--------|-----|---------------|-----|---------------|-----|---------------|-----|---------------|-----|---------------|-----|---------------|---------------------------------------------------------------------------------------------------------------------------------------------------------------------------------------------------------------------------------------------------------------------------------------------------------|-----------|--------|-----|---------------|-----|---------------|-----|---------------|-----|---------------|
| 46.2 mm - overall length<br>Primary<br>Small<br>VM30/38                                                                                                                                                                                                                                                 | 31.9 mm - overall length<br>Bleeder<br>Flat Slide<br>VM30/46                      | 41.2 mm - overall length<br>Bleeder<br>Round Slide<br>VM32/19                     | 48.4 mm - overall length<br>Primary<br>Round Slide<br>VM34/05                      | 47.3 mm - overall length<br>Primary<br>Round Slide<br>VM34/17                       |     |               |     |               |     |               |                                                                                                                                                                                                                                                                                                                                                                                                                                                      |           |        |     |               |     |               |     |               |     |               |     |               |     |               |     |               |                                                                                                                                                                                                                                                                                                         |           |        |     |               |     |               |     |               |     |               |                                                                                                                                                                                                                                                                                                                                                                                                       |           |        |     |               |     |               |     |               |     |               |     |               |     |               |                                                                                                                                                                                                                                                                                                         |           |        |     |               |     |               |     |               |     |               |
| <table border="1"> <thead> <tr> <th>JET SIZES</th> <th>PART #</th> </tr> </thead> <tbody> <tr> <td>P-0</td> <td><b>917657</b></td> </tr> <tr> <td>P-2</td> <td><b>917658</b></td> </tr> <tr> <td>P-4</td> <td><b>917659</b></td> </tr> <tr> <td>P-6</td> <td><b>917661</b></td> </tr> </tbody> </table> | JET SIZES                                                                         | PART #                                                                            | P-0                                                                                | <b>917657</b>                                                                       | P-2 | <b>917658</b> | P-4 | <b>917659</b> | P-6 | <b>917661</b> | <table border="1"> <thead> <tr> <th>JET SIZES</th> <th>PART #</th> </tr> </thead> <tbody> <tr> <td>O-6</td> <td><b>917665</b></td> </tr> <tr> <td>O-8</td> <td><b>917666</b></td> </tr> <tr> <td>P-0</td> <td><b>917667</b></td> </tr> <tr> <td>P-2</td> <td><b>917668</b></td> </tr> <tr> <td>P-4</td> <td><b>917669</b></td> </tr> <tr> <td>P-6</td> <td><b>917671</b></td> </tr> <tr> <td>P-8</td> <td><b>917672</b></td> </tr> </tbody> </table> | JET SIZES | PART # | O-6 | <b>917665</b> | O-8 | <b>917666</b> | P-0 | <b>917667</b> | P-2 | <b>917668</b> | P-4 | <b>917669</b> | P-6 | <b>917671</b> | P-8 | <b>917672</b> | <table border="1"> <thead> <tr> <th>JET SIZES</th> <th>PART #</th> </tr> </thead> <tbody> <tr> <td>O-4</td> <td><b>917681</b></td> </tr> <tr> <td>O-6</td> <td><b>917682</b></td> </tr> <tr> <td>O-8</td> <td><b>917683</b></td> </tr> <tr> <td>P-6</td> <td><b>917684</b></td> </tr> </tbody> </table> | JET SIZES | PART # | O-4 | <b>917681</b> | O-6 | <b>917682</b> | O-8 | <b>917683</b> | P-6 | <b>917684</b> | <table border="1"> <thead> <tr> <th>JET SIZES</th> <th>PART #</th> </tr> </thead> <tbody> <tr> <td>N-4</td> <td><b>917705</b></td> </tr> <tr> <td>N-8</td> <td><b>917706</b></td> </tr> <tr> <td>O-0</td> <td><b>917707</b></td> </tr> <tr> <td>O-2</td> <td><b>917708</b></td> </tr> <tr> <td>O-4</td> <td><b>917709</b></td> </tr> <tr> <td>O-6</td> <td><b>917711</b></td> </tr> </tbody> </table> | JET SIZES | PART # | N-4 | <b>917705</b> | N-8 | <b>917706</b> | O-0 | <b>917707</b> | O-2 | <b>917708</b> | O-4 | <b>917709</b> | O-6 | <b>917711</b> | <table border="1"> <thead> <tr> <th>JET SIZES</th> <th>PART #</th> </tr> </thead> <tbody> <tr> <td>O-0</td> <td><b>917724</b></td> </tr> <tr> <td>O-2</td> <td><b>917725</b></td> </tr> <tr> <td>O-4</td> <td><b>917726</b></td> </tr> <tr> <td>O-6</td> <td><b>917727</b></td> </tr> </tbody> </table> | JET SIZES | PART # | O-0 | <b>917724</b> | O-2 | <b>917725</b> | O-4 | <b>917726</b> | O-6 | <b>917727</b> |
| JET SIZES                                                                                                                                                                                                                                                                                               | PART #                                                                            |                                                                                   |                                                                                    |                                                                                     |     |               |     |               |     |               |                                                                                                                                                                                                                                                                                                                                                                                                                                                      |           |        |     |               |     |               |     |               |     |               |     |               |     |               |     |               |                                                                                                                                                                                                                                                                                                         |           |        |     |               |     |               |     |               |     |               |                                                                                                                                                                                                                                                                                                                                                                                                       |           |        |     |               |     |               |     |               |     |               |     |               |     |               |                                                                                                                                                                                                                                                                                                         |           |        |     |               |     |               |     |               |     |               |
| P-0                                                                                                                                                                                                                                                                                                     | <b>917657</b>                                                                     |                                                                                   |                                                                                    |                                                                                     |     |               |     |               |     |               |                                                                                                                                                                                                                                                                                                                                                                                                                                                      |           |        |     |               |     |               |     |               |     |               |     |               |     |               |     |               |                                                                                                                                                                                                                                                                                                         |           |        |     |               |     |               |     |               |     |               |                                                                                                                                                                                                                                                                                                                                                                                                       |           |        |     |               |     |               |     |               |     |               |     |               |     |               |                                                                                                                                                                                                                                                                                                         |           |        |     |               |     |               |     |               |     |               |
| P-2                                                                                                                                                                                                                                                                                                     | <b>917658</b>                                                                     |                                                                                   |                                                                                    |                                                                                     |     |               |     |               |     |               |                                                                                                                                                                                                                                                                                                                                                                                                                                                      |           |        |     |               |     |               |     |               |     |               |     |               |     |               |     |               |                                                                                                                                                                                                                                                                                                         |           |        |     |               |     |               |     |               |     |               |                                                                                                                                                                                                                                                                                                                                                                                                       |           |        |     |               |     |               |     |               |     |               |     |               |     |               |                                                                                                                                                                                                                                                                                                         |           |        |     |               |     |               |     |               |     |               |
| P-4                                                                                                                                                                                                                                                                                                     | <b>917659</b>                                                                     |                                                                                   |                                                                                    |                                                                                     |     |               |     |               |     |               |                                                                                                                                                                                                                                                                                                                                                                                                                                                      |           |        |     |               |     |               |     |               |     |               |     |               |     |               |     |               |                                                                                                                                                                                                                                                                                                         |           |        |     |               |     |               |     |               |     |               |                                                                                                                                                                                                                                                                                                                                                                                                       |           |        |     |               |     |               |     |               |     |               |     |               |     |               |                                                                                                                                                                                                                                                                                                         |           |        |     |               |     |               |     |               |     |               |
| P-6                                                                                                                                                                                                                                                                                                     | <b>917661</b>                                                                     |                                                                                   |                                                                                    |                                                                                     |     |               |     |               |     |               |                                                                                                                                                                                                                                                                                                                                                                                                                                                      |           |        |     |               |     |               |     |               |     |               |     |               |     |               |     |               |                                                                                                                                                                                                                                                                                                         |           |        |     |               |     |               |     |               |     |               |                                                                                                                                                                                                                                                                                                                                                                                                       |           |        |     |               |     |               |     |               |     |               |     |               |     |               |                                                                                                                                                                                                                                                                                                         |           |        |     |               |     |               |     |               |     |               |
| JET SIZES                                                                                                                                                                                                                                                                                               | PART #                                                                            |                                                                                   |                                                                                    |                                                                                     |     |               |     |               |     |               |                                                                                                                                                                                                                                                                                                                                                                                                                                                      |           |        |     |               |     |               |     |               |     |               |     |               |     |               |     |               |                                                                                                                                                                                                                                                                                                         |           |        |     |               |     |               |     |               |     |               |                                                                                                                                                                                                                                                                                                                                                                                                       |           |        |     |               |     |               |     |               |     |               |     |               |     |               |                                                                                                                                                                                                                                                                                                         |           |        |     |               |     |               |     |               |     |               |
| O-6                                                                                                                                                                                                                                                                                                     | <b>917665</b>                                                                     |                                                                                   |                                                                                    |                                                                                     |     |               |     |               |     |               |                                                                                                                                                                                                                                                                                                                                                                                                                                                      |           |        |     |               |     |               |     |               |     |               |     |               |     |               |     |               |                                                                                                                                                                                                                                                                                                         |           |        |     |               |     |               |     |               |     |               |                                                                                                                                                                                                                                                                                                                                                                                                       |           |        |     |               |     |               |     |               |     |               |     |               |     |               |                                                                                                                                                                                                                                                                                                         |           |        |     |               |     |               |     |               |     |               |
| O-8                                                                                                                                                                                                                                                                                                     | <b>917666</b>                                                                     |                                                                                   |                                                                                    |                                                                                     |     |               |     |               |     |               |                                                                                                                                                                                                                                                                                                                                                                                                                                                      |           |        |     |               |     |               |     |               |     |               |     |               |     |               |     |               |                                                                                                                                                                                                                                                                                                         |           |        |     |               |     |               |     |               |     |               |                                                                                                                                                                                                                                                                                                                                                                                                       |           |        |     |               |     |               |     |               |     |               |     |               |     |               |                                                                                                                                                                                                                                                                                                         |           |        |     |               |     |               |     |               |     |               |
| P-0                                                                                                                                                                                                                                                                                                     | <b>917667</b>                                                                     |                                                                                   |                                                                                    |                                                                                     |     |               |     |               |     |               |                                                                                                                                                                                                                                                                                                                                                                                                                                                      |           |        |     |               |     |               |     |               |     |               |     |               |     |               |     |               |                                                                                                                                                                                                                                                                                                         |           |        |     |               |     |               |     |               |     |               |                                                                                                                                                                                                                                                                                                                                                                                                       |           |        |     |               |     |               |     |               |     |               |     |               |     |               |                                                                                                                                                                                                                                                                                                         |           |        |     |               |     |               |     |               |     |               |
| P-2                                                                                                                                                                                                                                                                                                     | <b>917668</b>                                                                     |                                                                                   |                                                                                    |                                                                                     |     |               |     |               |     |               |                                                                                                                                                                                                                                                                                                                                                                                                                                                      |           |        |     |               |     |               |     |               |     |               |     |               |     |               |     |               |                                                                                                                                                                                                                                                                                                         |           |        |     |               |     |               |     |               |     |               |                                                                                                                                                                                                                                                                                                                                                                                                       |           |        |     |               |     |               |     |               |     |               |     |               |     |               |                                                                                                                                                                                                                                                                                                         |           |        |     |               |     |               |     |               |     |               |
| P-4                                                                                                                                                                                                                                                                                                     | <b>917669</b>                                                                     |                                                                                   |                                                                                    |                                                                                     |     |               |     |               |     |               |                                                                                                                                                                                                                                                                                                                                                                                                                                                      |           |        |     |               |     |               |     |               |     |               |     |               |     |               |     |               |                                                                                                                                                                                                                                                                                                         |           |        |     |               |     |               |     |               |     |               |                                                                                                                                                                                                                                                                                                                                                                                                       |           |        |     |               |     |               |     |               |     |               |     |               |     |               |                                                                                                                                                                                                                                                                                                         |           |        |     |               |     |               |     |               |     |               |
| P-6                                                                                                                                                                                                                                                                                                     | <b>917671</b>                                                                     |                                                                                   |                                                                                    |                                                                                     |     |               |     |               |     |               |                                                                                                                                                                                                                                                                                                                                                                                                                                                      |           |        |     |               |     |               |     |               |     |               |     |               |     |               |     |               |                                                                                                                                                                                                                                                                                                         |           |        |     |               |     |               |     |               |     |               |                                                                                                                                                                                                                                                                                                                                                                                                       |           |        |     |               |     |               |     |               |     |               |     |               |     |               |                                                                                                                                                                                                                                                                                                         |           |        |     |               |     |               |     |               |     |               |
| P-8                                                                                                                                                                                                                                                                                                     | <b>917672</b>                                                                     |                                                                                   |                                                                                    |                                                                                     |     |               |     |               |     |               |                                                                                                                                                                                                                                                                                                                                                                                                                                                      |           |        |     |               |     |               |     |               |     |               |     |               |     |               |     |               |                                                                                                                                                                                                                                                                                                         |           |        |     |               |     |               |     |               |     |               |                                                                                                                                                                                                                                                                                                                                                                                                       |           |        |     |               |     |               |     |               |     |               |     |               |     |               |                                                                                                                                                                                                                                                                                                         |           |        |     |               |     |               |     |               |     |               |
| JET SIZES                                                                                                                                                                                                                                                                                               | PART #                                                                            |                                                                                   |                                                                                    |                                                                                     |     |               |     |               |     |               |                                                                                                                                                                                                                                                                                                                                                                                                                                                      |           |        |     |               |     |               |     |               |     |               |     |               |     |               |     |               |                                                                                                                                                                                                                                                                                                         |           |        |     |               |     |               |     |               |     |               |                                                                                                                                                                                                                                                                                                                                                                                                       |           |        |     |               |     |               |     |               |     |               |     |               |     |               |                                                                                                                                                                                                                                                                                                         |           |        |     |               |     |               |     |               |     |               |
| O-4                                                                                                                                                                                                                                                                                                     | <b>917681</b>                                                                     |                                                                                   |                                                                                    |                                                                                     |     |               |     |               |     |               |                                                                                                                                                                                                                                                                                                                                                                                                                                                      |           |        |     |               |     |               |     |               |     |               |     |               |     |               |     |               |                                                                                                                                                                                                                                                                                                         |           |        |     |               |     |               |     |               |     |               |                                                                                                                                                                                                                                                                                                                                                                                                       |           |        |     |               |     |               |     |               |     |               |     |               |     |               |                                                                                                                                                                                                                                                                                                         |           |        |     |               |     |               |     |               |     |               |
| O-6                                                                                                                                                                                                                                                                                                     | <b>917682</b>                                                                     |                                                                                   |                                                                                    |                                                                                     |     |               |     |               |     |               |                                                                                                                                                                                                                                                                                                                                                                                                                                                      |           |        |     |               |     |               |     |               |     |               |     |               |     |               |     |               |                                                                                                                                                                                                                                                                                                         |           |        |     |               |     |               |     |               |     |               |                                                                                                                                                                                                                                                                                                                                                                                                       |           |        |     |               |     |               |     |               |     |               |     |               |     |               |                                                                                                                                                                                                                                                                                                         |           |        |     |               |     |               |     |               |     |               |
| O-8                                                                                                                                                                                                                                                                                                     | <b>917683</b>                                                                     |                                                                                   |                                                                                    |                                                                                     |     |               |     |               |     |               |                                                                                                                                                                                                                                                                                                                                                                                                                                                      |           |        |     |               |     |               |     |               |     |               |     |               |     |               |     |               |                                                                                                                                                                                                                                                                                                         |           |        |     |               |     |               |     |               |     |               |                                                                                                                                                                                                                                                                                                                                                                                                       |           |        |     |               |     |               |     |               |     |               |     |               |     |               |                                                                                                                                                                                                                                                                                                         |           |        |     |               |     |               |     |               |     |               |
| P-6                                                                                                                                                                                                                                                                                                     | <b>917684</b>                                                                     |                                                                                   |                                                                                    |                                                                                     |     |               |     |               |     |               |                                                                                                                                                                                                                                                                                                                                                                                                                                                      |           |        |     |               |     |               |     |               |     |               |     |               |     |               |     |               |                                                                                                                                                                                                                                                                                                         |           |        |     |               |     |               |     |               |     |               |                                                                                                                                                                                                                                                                                                                                                                                                       |           |        |     |               |     |               |     |               |     |               |     |               |     |               |                                                                                                                                                                                                                                                                                                         |           |        |     |               |     |               |     |               |     |               |
| JET SIZES                                                                                                                                                                                                                                                                                               | PART #                                                                            |                                                                                   |                                                                                    |                                                                                     |     |               |     |               |     |               |                                                                                                                                                                                                                                                                                                                                                                                                                                                      |           |        |     |               |     |               |     |               |     |               |     |               |     |               |     |               |                                                                                                                                                                                                                                                                                                         |           |        |     |               |     |               |     |               |     |               |                                                                                                                                                                                                                                                                                                                                                                                                       |           |        |     |               |     |               |     |               |     |               |     |               |     |               |                                                                                                                                                                                                                                                                                                         |           |        |     |               |     |               |     |               |     |               |
| N-4                                                                                                                                                                                                                                                                                                     | <b>917705</b>                                                                     |                                                                                   |                                                                                    |                                                                                     |     |               |     |               |     |               |                                                                                                                                                                                                                                                                                                                                                                                                                                                      |           |        |     |               |     |               |     |               |     |               |     |               |     |               |     |               |                                                                                                                                                                                                                                                                                                         |           |        |     |               |     |               |     |               |     |               |                                                                                                                                                                                                                                                                                                                                                                                                       |           |        |     |               |     |               |     |               |     |               |     |               |     |               |                                                                                                                                                                                                                                                                                                         |           |        |     |               |     |               |     |               |     |               |
| N-8                                                                                                                                                                                                                                                                                                     | <b>917706</b>                                                                     |                                                                                   |                                                                                    |                                                                                     |     |               |     |               |     |               |                                                                                                                                                                                                                                                                                                                                                                                                                                                      |           |        |     |               |     |               |     |               |     |               |     |               |     |               |     |               |                                                                                                                                                                                                                                                                                                         |           |        |     |               |     |               |     |               |     |               |                                                                                                                                                                                                                                                                                                                                                                                                       |           |        |     |               |     |               |     |               |     |               |     |               |     |               |                                                                                                                                                                                                                                                                                                         |           |        |     |               |     |               |     |               |     |               |
| O-0                                                                                                                                                                                                                                                                                                     | <b>917707</b>                                                                     |                                                                                   |                                                                                    |                                                                                     |     |               |     |               |     |               |                                                                                                                                                                                                                                                                                                                                                                                                                                                      |           |        |     |               |     |               |     |               |     |               |     |               |     |               |     |               |                                                                                                                                                                                                                                                                                                         |           |        |     |               |     |               |     |               |     |               |                                                                                                                                                                                                                                                                                                                                                                                                       |           |        |     |               |     |               |     |               |     |               |     |               |     |               |                                                                                                                                                                                                                                                                                                         |           |        |     |               |     |               |     |               |     |               |
| O-2                                                                                                                                                                                                                                                                                                     | <b>917708</b>                                                                     |                                                                                   |                                                                                    |                                                                                     |     |               |     |               |     |               |                                                                                                                                                                                                                                                                                                                                                                                                                                                      |           |        |     |               |     |               |     |               |     |               |     |               |     |               |     |               |                                                                                                                                                                                                                                                                                                         |           |        |     |               |     |               |     |               |     |               |                                                                                                                                                                                                                                                                                                                                                                                                       |           |        |     |               |     |               |     |               |     |               |     |               |     |               |                                                                                                                                                                                                                                                                                                         |           |        |     |               |     |               |     |               |     |               |
| O-4                                                                                                                                                                                                                                                                                                     | <b>917709</b>                                                                     |                                                                                   |                                                                                    |                                                                                     |     |               |     |               |     |               |                                                                                                                                                                                                                                                                                                                                                                                                                                                      |           |        |     |               |     |               |     |               |     |               |     |               |     |               |     |               |                                                                                                                                                                                                                                                                                                         |           |        |     |               |     |               |     |               |     |               |                                                                                                                                                                                                                                                                                                                                                                                                       |           |        |     |               |     |               |     |               |     |               |     |               |     |               |                                                                                                                                                                                                                                                                                                         |           |        |     |               |     |               |     |               |     |               |
| O-6                                                                                                                                                                                                                                                                                                     | <b>917711</b>                                                                     |                                                                                   |                                                                                    |                                                                                     |     |               |     |               |     |               |                                                                                                                                                                                                                                                                                                                                                                                                                                                      |           |        |     |               |     |               |     |               |     |               |     |               |     |               |     |               |                                                                                                                                                                                                                                                                                                         |           |        |     |               |     |               |     |               |     |               |                                                                                                                                                                                                                                                                                                                                                                                                       |           |        |     |               |     |               |     |               |     |               |     |               |     |               |                                                                                                                                                                                                                                                                                                         |           |        |     |               |     |               |     |               |     |               |
| JET SIZES                                                                                                                                                                                                                                                                                               | PART #                                                                            |                                                                                   |                                                                                    |                                                                                     |     |               |     |               |     |               |                                                                                                                                                                                                                                                                                                                                                                                                                                                      |           |        |     |               |     |               |     |               |     |               |     |               |     |               |     |               |                                                                                                                                                                                                                                                                                                         |           |        |     |               |     |               |     |               |     |               |                                                                                                                                                                                                                                                                                                                                                                                                       |           |        |     |               |     |               |     |               |     |               |     |               |     |               |                                                                                                                                                                                                                                                                                                         |           |        |     |               |     |               |     |               |     |               |
| O-0                                                                                                                                                                                                                                                                                                     | <b>917724</b>                                                                     |                                                                                   |                                                                                    |                                                                                     |     |               |     |               |     |               |                                                                                                                                                                                                                                                                                                                                                                                                                                                      |           |        |     |               |     |               |     |               |     |               |     |               |     |               |     |               |                                                                                                                                                                                                                                                                                                         |           |        |     |               |     |               |     |               |     |               |                                                                                                                                                                                                                                                                                                                                                                                                       |           |        |     |               |     |               |     |               |     |               |     |               |     |               |                                                                                                                                                                                                                                                                                                         |           |        |     |               |     |               |     |               |     |               |
| O-2                                                                                                                                                                                                                                                                                                     | <b>917725</b>                                                                     |                                                                                   |                                                                                    |                                                                                     |     |               |     |               |     |               |                                                                                                                                                                                                                                                                                                                                                                                                                                                      |           |        |     |               |     |               |     |               |     |               |     |               |     |               |     |               |                                                                                                                                                                                                                                                                                                         |           |        |     |               |     |               |     |               |     |               |                                                                                                                                                                                                                                                                                                                                                                                                       |           |        |     |               |     |               |     |               |     |               |     |               |     |               |                                                                                                                                                                                                                                                                                                         |           |        |     |               |     |               |     |               |     |               |
| O-4                                                                                                                                                                                                                                                                                                     | <b>917726</b>                                                                     |                                                                                   |                                                                                    |                                                                                     |     |               |     |               |     |               |                                                                                                                                                                                                                                                                                                                                                                                                                                                      |           |        |     |               |     |               |     |               |     |               |     |               |     |               |     |               |                                                                                                                                                                                                                                                                                                         |           |        |     |               |     |               |     |               |     |               |                                                                                                                                                                                                                                                                                                                                                                                                       |           |        |     |               |     |               |     |               |     |               |     |               |     |               |                                                                                                                                                                                                                                                                                                         |           |        |     |               |     |               |     |               |     |               |
| O-6                                                                                                                                                                                                                                                                                                     | <b>917727</b>                                                                     |                                                                                   |                                                                                    |                                                                                     |     |               |     |               |     |               |                                                                                                                                                                                                                                                                                                                                                                                                                                                      |           |        |     |               |     |               |     |               |     |               |     |               |     |               |     |               |                                                                                                                                                                                                                                                                                                         |           |        |     |               |     |               |     |               |     |               |                                                                                                                                                                                                                                                                                                                                                                                                       |           |        |     |               |     |               |     |               |     |               |     |               |     |               |                                                                                                                                                                                                                                                                                                         |           |        |     |               |     |               |     |               |     |               |

## MIKUNI NEEDLE JET • BLEEDER TYPE

The needle jet is the main fuel passage to the main bore of the Mikuni carburetor. Depending on the inside diameter of a specific needle jet, this will also affect the function of the needle. Therefore, needle jets and needles act together as the main system in controlling the amount and mixture of the fuel which is drawn in mid-range 1/4-3/4 throttle operation.

|  | <table border="1"> <thead> <tr> <th>JET SIZES</th> <th>PART #</th> </tr> </thead> <tbody> <tr> <td>P-2</td> <td><b>917786</b></td> </tr> <tr> <td>P-6</td> <td><b>917788</b></td> </tr> <tr> <td>Q-6</td> <td><b>917793</b></td> </tr> <tr> <td>Q-8</td> <td><b>917794</b></td> </tr> <tr> <td>R-0</td> <td><b>917795</b></td> </tr> <tr> <td>R-2</td> <td><b>917796</b></td> </tr> <tr> <td>R-4</td> <td><b>917797</b></td> </tr> <tr> <td>R-6</td> <td><b>917798</b></td> </tr> <tr> <td>R-8</td> <td><b>917799</b></td> </tr> </tbody> </table> | JET SIZES                                                     | PART # | P-2 | <b>917786</b> | P-6 | <b>917788</b> | Q-6 | <b>917793</b> | Q-8 | <b>917794</b> | R-0 | <b>917795</b> | R-2 | <b>917796</b> | R-4 | <b>917797</b> | R-6 | <b>917798</b> | R-8 | <b>917799</b> |  | <table border="1"> <thead> <tr> <th>JET SIZES</th> <th>PART #</th> </tr> </thead> <tbody> <tr> <td>AA-0</td> <td><b>917818</b></td> </tr> <tr> <td>AA-5</td> <td><b>917822</b></td> </tr> <tr> <td>CC-0</td> <td><b>917828</b></td> </tr> <tr> <td>Z-0</td> <td><b>917830</b></td> </tr> <tr> <td>Z-5</td> <td><b>917831</b></td> </tr> </tbody> </table> | JET SIZES | PART # | AA-0 | <b>917818</b> | AA-5 | <b>917822</b> | CC-0 | <b>917828</b> | Z-0 | <b>917830</b> | Z-5 | <b>917831</b> |
|-------------------------------------------------------------------------------------|----------------------------------------------------------------------------------------------------------------------------------------------------------------------------------------------------------------------------------------------------------------------------------------------------------------------------------------------------------------------------------------------------------------------------------------------------------------------------------------------------------------------------------------------------|---------------------------------------------------------------|--------|-----|---------------|-----|---------------|-----|---------------|-----|---------------|-----|---------------|-----|---------------|-----|---------------|-----|---------------|-----|---------------|--------------------------------------------------------------------------------------|-----------------------------------------------------------------------------------------------------------------------------------------------------------------------------------------------------------------------------------------------------------------------------------------------------------------------------------------------------------|-----------|--------|------|---------------|------|---------------|------|---------------|-----|---------------|-----|---------------|
| JET SIZES                                                                           | PART #                                                                                                                                                                                                                                                                                                                                                                                                                                                                                                                                             |                                                               |        |     |               |     |               |     |               |     |               |     |               |     |               |     |               |     |               |     |               |                                                                                      |                                                                                                                                                                                                                                                                                                                                                           |           |        |      |               |      |               |      |               |     |               |     |               |
| P-2                                                                                 | <b>917786</b>                                                                                                                                                                                                                                                                                                                                                                                                                                                                                                                                      |                                                               |        |     |               |     |               |     |               |     |               |     |               |     |               |     |               |     |               |     |               |                                                                                      |                                                                                                                                                                                                                                                                                                                                                           |           |        |      |               |      |               |      |               |     |               |     |               |
| P-6                                                                                 | <b>917788</b>                                                                                                                                                                                                                                                                                                                                                                                                                                                                                                                                      |                                                               |        |     |               |     |               |     |               |     |               |     |               |     |               |     |               |     |               |     |               |                                                                                      |                                                                                                                                                                                                                                                                                                                                                           |           |        |      |               |      |               |      |               |     |               |     |               |
| Q-6                                                                                 | <b>917793</b>                                                                                                                                                                                                                                                                                                                                                                                                                                                                                                                                      |                                                               |        |     |               |     |               |     |               |     |               |     |               |     |               |     |               |     |               |     |               |                                                                                      |                                                                                                                                                                                                                                                                                                                                                           |           |        |      |               |      |               |      |               |     |               |     |               |
| Q-8                                                                                 | <b>917794</b>                                                                                                                                                                                                                                                                                                                                                                                                                                                                                                                                      |                                                               |        |     |               |     |               |     |               |     |               |     |               |     |               |     |               |     |               |     |               |                                                                                      |                                                                                                                                                                                                                                                                                                                                                           |           |        |      |               |      |               |      |               |     |               |     |               |
| R-0                                                                                 | <b>917795</b>                                                                                                                                                                                                                                                                                                                                                                                                                                                                                                                                      |                                                               |        |     |               |     |               |     |               |     |               |     |               |     |               |     |               |     |               |     |               |                                                                                      |                                                                                                                                                                                                                                                                                                                                                           |           |        |      |               |      |               |      |               |     |               |     |               |
| R-2                                                                                 | <b>917796</b>                                                                                                                                                                                                                                                                                                                                                                                                                                                                                                                                      |                                                               |        |     |               |     |               |     |               |     |               |     |               |     |               |     |               |     |               |     |               |                                                                                      |                                                                                                                                                                                                                                                                                                                                                           |           |        |      |               |      |               |      |               |     |               |     |               |
| R-4                                                                                 | <b>917797</b>                                                                                                                                                                                                                                                                                                                                                                                                                                                                                                                                      |                                                               |        |     |               |     |               |     |               |     |               |     |               |     |               |     |               |     |               |     |               |                                                                                      |                                                                                                                                                                                                                                                                                                                                                           |           |        |      |               |      |               |      |               |     |               |     |               |
| R-6                                                                                 | <b>917798</b>                                                                                                                                                                                                                                                                                                                                                                                                                                                                                                                                      |                                                               |        |     |               |     |               |     |               |     |               |     |               |     |               |     |               |     |               |     |               |                                                                                      |                                                                                                                                                                                                                                                                                                                                                           |           |        |      |               |      |               |      |               |     |               |     |               |
| R-8                                                                                 | <b>917799</b>                                                                                                                                                                                                                                                                                                                                                                                                                                                                                                                                      |                                                               |        |     |               |     |               |     |               |     |               |     |               |     |               |     |               |     |               |     |               |                                                                                      |                                                                                                                                                                                                                                                                                                                                                           |           |        |      |               |      |               |      |               |     |               |     |               |
| JET SIZES                                                                           | PART #                                                                                                                                                                                                                                                                                                                                                                                                                                                                                                                                             |                                                               |        |     |               |     |               |     |               |     |               |     |               |     |               |     |               |     |               |     |               |                                                                                      |                                                                                                                                                                                                                                                                                                                                                           |           |        |      |               |      |               |      |               |     |               |     |               |
| AA-0                                                                                | <b>917818</b>                                                                                                                                                                                                                                                                                                                                                                                                                                                                                                                                      |                                                               |        |     |               |     |               |     |               |     |               |     |               |     |               |     |               |     |               |     |               |                                                                                      |                                                                                                                                                                                                                                                                                                                                                           |           |        |      |               |      |               |      |               |     |               |     |               |
| AA-5                                                                                | <b>917822</b>                                                                                                                                                                                                                                                                                                                                                                                                                                                                                                                                      |                                                               |        |     |               |     |               |     |               |     |               |     |               |     |               |     |               |     |               |     |               |                                                                                      |                                                                                                                                                                                                                                                                                                                                                           |           |        |      |               |      |               |      |               |     |               |     |               |
| CC-0                                                                                | <b>917828</b>                                                                                                                                                                                                                                                                                                                                                                                                                                                                                                                                      |                                                               |        |     |               |     |               |     |               |     |               |     |               |     |               |     |               |     |               |     |               |                                                                                      |                                                                                                                                                                                                                                                                                                                                                           |           |        |      |               |      |               |      |               |     |               |     |               |
| Z-0                                                                                 | <b>917830</b>                                                                                                                                                                                                                                                                                                                                                                                                                                                                                                                                      |                                                               |        |     |               |     |               |     |               |     |               |     |               |     |               |     |               |     |               |     |               |                                                                                      |                                                                                                                                                                                                                                                                                                                                                           |           |        |      |               |      |               |      |               |     |               |     |               |
| Z-5                                                                                 | <b>917831</b>                                                                                                                                                                                                                                                                                                                                                                                                                                                                                                                                      |                                                               |        |     |               |     |               |     |               |     |               |     |               |     |               |     |               |     |               |     |               |                                                                                      |                                                                                                                                                                                                                                                                                                                                                           |           |        |      |               |      |               |      |               |     |               |     |               |
| 54.4 mm - overall length<br>Primary<br>Round Slide<br>VM38/41                       |                                                                                                                                                                                                                                                                                                                                                                                                                                                                                                                                                    | 62.1 mm - overall length<br>Primary<br>Round Slide<br>VM44/10 |        |     |               |     |               |     |               |     |               |     |               |     |               |     |               |     |               |     |               |                                                                                      |                                                                                                                                                                                                                                                                                                                                                           |           |        |      |               |      |               |      |               |     |               |     |               |

MIKUNI THROTTLE VALVE



| VM32/65   |               | VM34/110  |               | VM36/36   |               | VM38/24   |               | VM38/52   |               |
|-----------|---------------|-----------|---------------|-----------|---------------|-----------|---------------|-----------|---------------|
| JET SIZES | PART #        | JET SIZES | PART #        | JET SIZES | PART #        | JET SIZES | PART #        | JET SIZES | PART #        |
| 2.0       | <b>917689</b> | 1.5       | <b>917716</b> | 1.5       | <b>917760</b> | 2.0       | <b>917781</b> | 2.0       | <b>917801</b> |
| 2.5       | <b>917690</b> | 2.0       | <b>917717</b> | 2.0       | <b>917761</b> | 2.5       | <b>917782</b> | 2.5       | <b>917802</b> |
| 3.0       | <b>917691</b> | 2.5       | <b>917718</b> | 2.5       | <b>917762</b> | 3.0       | <b>917783</b> | 3.0       | <b>917803</b> |
|           |               | 3.0       | <b>917719</b> | 3.0       | <b>917763</b> | 3.5       | <b>917784</b> |           |               |

| VM40/02   |               | VM44/23   |               |
|-----------|---------------|-----------|---------------|
| JET SIZES | PART #        | JET SIZES | PART #        |
| 1.5       | <b>917808</b> | 2.5       | <b>917836</b> |
| 2.0       | <b>917809</b> | 3.0       | <b>917837</b> |
| 2.5       | <b>917810</b> | 3.5       | <b>917838</b> |
| 3.0       | <b>917811</b> |           |               |



MIKUNI SPRING PLATE

- Mikuni Spring Plate - VM32/17
- Spring plate for starter lever on VM30 thru 44.

**917679**



MIKUNI RUBBER FLANGE

- Mikuni Rubber Flange - VM32/454
- This Mikuni mounting flange has a bolt pattern of 74.6, bolt hole is 8.5, bolt size is 34, throat depth is 32, spigot diameter is 40, and it fits VM30-34 carburetors. The stud pattern is HD, Mikuni # is VM32/205, stud opening is 3", carb opening is 1 9/16".

**917686**



MIKUNI TOP (VM34/28 29)

- Mikuni TOP (VM34/28 29 - VM34/27
- Mikuni Mixing Chamber Top with Gasket
- Fits 30-34 mm carbs

**917730**



MIKUNI SPRING SEAT PLATE

- Mikuni Spring Seat Plate - VM34/31
- Spring Seat Plate for VM30, VM32 and VM34 Carb

**917732**



## MIKUNI FLOAT CHAMBER GASKET

- Mikuni Float Chamber Gasket - VM34/374
- Float Bowl Gasket, 36-38mm Flat Slide

**917734**



## MIKUNI FLOAT BOWL DRAIN PLUG

- Mikuni Float Bowl Drain Plug - VM34/42
- Float Bowl Drain Plug, 30 thru 34mm Spigot

**917740**



## MIKUNI FLOAT ASSEMBLY

- Mikuni Float Assembly - VM34/61
- Float for 30-34mm Carburetors

**917745**



## MIKUNI FLOAT ARM

- Mikuni Float Arm - VM34/73
- Mikuni Float Arm, 30 thru 34mm Spigot (39mm wide)

**917747**



## MIKUNI SPRING SEAT PLATE

- Mikuni Needle Retainer Plate for standard VM Style Carburetor

| SIZES   | PART #        |
|---------|---------------|
| VM35/09 | <b>917751</b> |
| VM36/16 | <b>917756</b> |
| VM44/09 | <b>917817</b> |



## MIKUNI TOP MIXING CHAMBER

- Mikuni Top Mixing Chamber - VM36/09 and VM44/05
- Top Mixing Chamber for VM36 & VM38 Carb - - VM36/09
- MIKUNI Mixing Chamber TopFits VM40 and VM44 carbsTop and Gasket Only - VM44/05

| SIZES   | PART #        |
|---------|---------------|
| VM36/09 | <b>917754</b> |
| VM44/05 | <b>917815</b> |

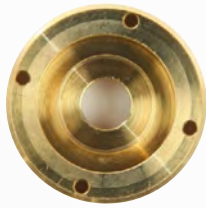

**MIKUNI CLIP MAIN JET**

- Mikuni CLIP MAIN JET - VM36/17
- Mikuni Fuel Retaining Cup for VM Style Carburetors.

**917757**



**MIKUNI CABLE ADJUST 32-28MM**

- CABLE ADJUST 32-28MM - VM36/83
- 7mm Cable adjuster with locknut

**917766**



**MIKUNI RUBBER FLANGE**

- Mikuni Rubber Flange - VM36-200-1 and VM40-200-1
- Mikuni 36mm-38mm and 40mm-44mm Rubber Flange Adapter
- Designed for spigot type carburetors

| SIZES      | PART #        |
|------------|---------------|
| VM36-200-1 | <b>917767</b> |
| VM40-200-1 | <b>917813</b> |



**MIKUNI EXTENDER**

- Mikuni EXTENDER - VM38/09
- Mikuni Need Jet Setter
- Sold Each

**917768**



**MIKUNI GASKET TOP CHAMBER**

- Mikuni GASKET TOP - VM38/127
- Mikuni TM Top Gasket
- Fits TM36 and TM38
- Not Applicable to TM32 and TM34

**917772**

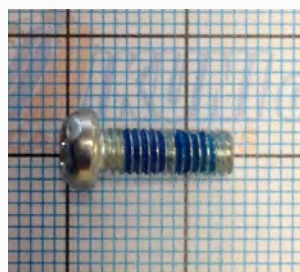

**MIKUNI JET BLOCK SCREW**

- Mikuni Jet Block Screw - VM38/132
- Mikuni Jet Block Screw for TM Carbs Fits All TM Series

**917773**



## MIKUNI CABLE CONNECTOR

- Mikuni Cable Connector - VM38/152
- Fits TM36 and TM38 Carburetors

**917775**



## MIKUNI NYLON RING

- Mikuni NYLON RING - VM38/153
- Mikuni Nylon ring for TM36 and 38 Carbs

**917776**



## MIKUNI IDLE ROD

- Mikuni IDLE ROD - VM38/159
- Mikuni Idle Rod for TM36 and TM38 Carbs
- \*Not applicable for TM28 thru TM34.

**917777**



## MIKUNI THROTTLE VALVE SPRING

- Mikuni Throttle Valve Spring - VM44/13
- Throttle valve return spring for spigot mounted VM40 and VM44 Mikuni carburetors

**917834**

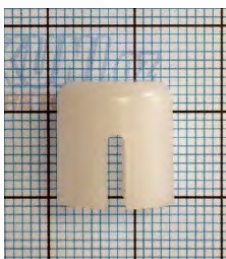

## MIKUNI PLASTIC CAP

- Mikuni Plastic Cap - VM35/40
- Idle Adjuster on TM36-2 and early TM8-1 and 3

**917752**



## MIKUNI \*USE NJ15906\* 159-06

- \*USE NJ15906\*
- USE NJ15906: This instruction means that the part number NJ15906 should be used in place of 159-06, likely because it's a newer version, has been replaced, or is the correct way to order it.

**NJ15906**

**MIKUNI – TILLOTSON CONVERSION KIT**



| DESCRIPTIONS | PART #        |
|--------------|---------------|
| “HR”         | <b>CRK100</b> |
| “HD”         | <b>CRK200</b> |

- This kit contains one each of the following, 30mm carb, mounting flange, throttle cable, choke cable, fuel pump, and fuel filter. This kit replaces Tiltson HR and Wallbro WR single carburetors. Replaces the old Tillotson Carburetor on your snowmobile, ATV, etc. with a modern Mikuni carburetor and fuel pump. (CRK100)
- This kit contains one each of the following, 34mm carb, mounting flange, throttle cable, choke cable, fuel pump, and fuel filter. This kit replaces Tiltson HR and Wallbro WR single carburetors. Replaces the old Tillotson carburetor on your snowmobile, ATV, etc. with a modern Mikuni carburetor and fuel pump. (CRK200)

**MIKUNI FLOAT BOWL MAIN JET BAFFLE PLATE VM28/227**

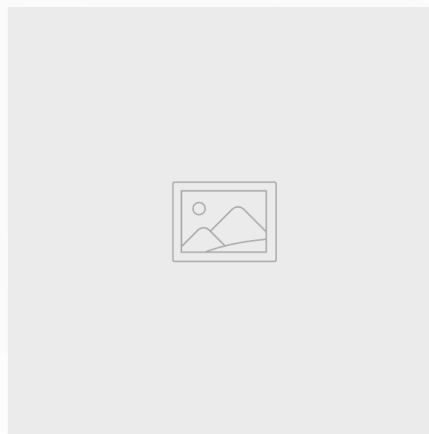

**VM28227**

- \*can't find in the internet



## MP CLEAR PVC VENT HOSE

- Constructed of plasticized PVC
- Soft flexible tubing
- Smooth hard bore helps prevent interior build up
- Recommended for venting and overflow lines
- Sold in 25 foot rolls and 3 ft lengths
- Safe flexible down to 0 degrees Fahrenheit
- Maximum dry heat temp is 220 degrees Fahrenheit
- Made in the USA

| SIZES           | PART #        |
|-----------------|---------------|
| 1/8 ID X 25 Ft  | <b>142544</b> |
| 3/16 ID X 25 Ft | <b>142545</b> |
| 1/4 ID X 25 Ft  | <b>142546</b> |
| 3/8 ID X 25 Ft  | <b>142548</b> |
| 5/16 ID X 25 Ft | <b>670003</b> |
| 5/16 ID X 3'    | <b>142605</b> |
| 3/8 ID X 3'     | <b>142606</b> |



## MP BRAIDED VINYL FUEL LINE

- Nylon-reinforced vinyl fuel line
- Braided nylon within the wall gives added strength
- Outstanding appearance for custom fuel lines
- Sold in 25 ft rolls
- Flexible down to +25 degrees Fahrenheit
- Maximum operating temp is 150 degrees Fahrenheit
- Made in the USA

| SIZES            | PART #        |
|------------------|---------------|
| 3/16" ID X 25 Ft | <b>142549</b> |
| 1/4" ID X 25 Ft  | <b>142550</b> |
| 5/16" ID X 25 Ft | <b>142551</b> |
| 3/8" ID X 25 Ft  | <b>142552</b> |
| 1/4" ID X 3'     | <b>142599</b> |
| 5/16" ID X 3'    | <b>142600</b> |
| 3/8" ID X 3'     | <b>142601</b> |



## MP PREMIUM FUEL LINE, GRAY

- Our best quality fuel line
- Stronger and more durable than vinyl fuel line
- Use with any type of gasoline
- Resists swelling and hardening
- Resistant to direct sunlight, hardening and/or cracking
- Flexible in temperatures from -35F to +165F
- Fuel line stretches easily over fittings or petcocks
- Sold in 25 ft rolls and 3 ft lengths
- Made in the USA

| SIZES          | PART #        |
|----------------|---------------|
| 3/16" ID X 25' | <b>142571</b> |
| 1/4" ID X 25'  | <b>142572</b> |
| 5/16" ID X 25' | <b>142573</b> |
| 3/16" ID X 3'  | <b>142589</b> |
| 1/4" ID X 3'   | <b>142592</b> |
| 5/16" ID X 3'  | <b>142595</b> |



## MP PREMIUM FUEL LINE, BLACK



- Our best quality fuel line
- Stronger and more durable than vinyl fuel line
- Use with any type of gasoline
- Resists swelling and hardening
- Resistant to direct sunlight, hardening and/or cracking
- Flexible in temperatures from -35F to +165F
- Fuel line stretches easily over fittings or petcocks
- Sold in 25 ft rolls and 3 ft lengths
- Made in the USA

| SIZES          | PART #        |
|----------------|---------------|
| 3/16" ID X 25' | <b>142580</b> |
| 1/4" ID X 25'  | <b>142581</b> |
| 5/16" ID X 25' | <b>142582</b> |
| 3/16" ID X 3'  | <b>142590</b> |
| 1/4" ID X 3'   | <b>142593</b> |
| 5/16" ID X 3'  | <b>142596</b> |

## MP PREMIUM FUEL LINE, CLEAR



- Our best quality fuel line
- Stronger and more durable than vinyl fuel line
- Use with any type of gasoline
- Resists swelling and hardening
- Resistant to direct sunlight, hardening and/or cracking
- Flexible in temperatures from -35F to +165F
- Fuel line stretches easily over fittings or petcocks
- Sold in 25 ft rolls and 3 ft lengths
- Made in the USA

| SIZES          | PART #        |
|----------------|---------------|
| 1/8" ID X 25'  | <b>142500</b> |
| 3/16" ID X 25' | <b>142583</b> |
| 1/4" ID X 25'  | <b>142584</b> |
| 5/16" ID X 25' | <b>143585</b> |
| 3/16" ID X 3'  | <b>142591</b> |
| 1/4" ID X 3'   | <b>142594</b> |
| 5/16" ID X 3'  | <b>142597</b> |

## MP LP (LOW PERMEATION) PREMIUM FUEL LINE



- Certified to meet permeation emission standards of 15g/M2/day
- On emission controlled vehicles, check with local and state agencies to determine suitability
- Robust multi-layer design and construction
- Fluoropolymer liner compatible with higher ethanol blend gasoline up to 100%
- Highly flexible, easy to install and offers excellent fitting retention
- Resistant to swelling, hardening and cracking caused by hydrocarbon-based fluids
- Ozone and UV light resistant
- Wide temperature range from -20°F to 165°F (-28.9°C to 73.9°C)
- Yellow color for easy identification

| SIZES          | PART #        |
|----------------|---------------|
| 5/16" ID X 25' | <b>142608</b> |
| 1/4" ID X 3'   | <b>142609</b> |
| 5/16" ID X 3'  | <b>142610</b> |



## MP QUICK DISCONNECT SINGLE/DUAL SHUT OFF



- Single shut-off valves
- When connected fuel will flow & when disconnected fuel will not flow
- For fuel supply (fuel tank to carburetor), use our original Quick-Disconnect Couplings with the single shut-off valve
- Available for 1/4" & 5/16" I.D. fuel line
- Capable of withstanding temperatures of -40 degrees F to 180 degrees F
- These fittings now come with Viton® type fluoroelastomer o-rings with superior chemical resistance
- Made in the USA
- Warning: Not for use with fuel injected engines

| SIZES        | PART #        |
|--------------|---------------|
| 5/16" S/T    | <b>142587</b> |
| 1/4" S/T     | <b>142588</b> |
| 1/4" SINGLE  | <b>672029</b> |
| 5/16" SINGLE | <b>672030</b> |
| 1/4" DUAL    | <b>672037</b> |
| 5/16" DUAL   | <b>672038</b> |

## MP FUEL VALVE, FITS 5/16" FUEL LINE



- Ideal for use on ATVs or other vehicles where an inline fuel petcock is necessary
- Not recommended for engines over 300 cc
- Rugged steel construction with zinc plating
- Viton O-ring stands up to most fuels

**142576**



## MP INLINE FUEL VALVE

- Inline fuel valve is ideal for use on ATVs or other vehicles where an inline fuel valve is necessary
- Rugged steel construction with zinc plating
- Viton O-ring stands up to most fuels

| SIZES                | PART #        |
|----------------------|---------------|
| fits 1/4" fuel line  | <b>142575</b> |
| 1/4" NPT x 1/4" barb | <b>142579</b> |

## MP INLINE FUEL VALVE



The Motion Pro Inline Fuel Valves are ideal for use on ATVs or other vehicles where an inline fuel petcock is necessary

| SIZES                  | PART #        |
|------------------------|---------------|
| 1/4" Barb X 5/16" Barb | <b>142586</b> |
| 3/16 Inch Hose         | <b>678038</b> |



## 5/16" X 5/16" BARB FITTING

- Forged brass body
- 5/16" x 5/16" barb
- Included in Universal FI repair hose kit part no.12-0086

**682787**



**MOTION PRO HOSE SHEARS**

- Scissor-action cutter
- Fast cutting of thin wall and small diameter PVC or Tygon type tubing
- Replaceable, Teflon-coated tool steel blades
- Blades can be re-sharpened

142553



**SIDE JAW PINCER TOOL  
(FOR 2-EAR & STEPLESS®  
1-EAR CLAMPS)**

- Used to install Stepless® Ear Clamps
- Side jaw design for use where space is restricted
- Replaces HD tool #HD-41137

142611





**POLISPORT FUEL FILTER - 6MM**



998416

- 50 units box
- Universal in line fuel filter for fuel hose. Transparent fuel resistant plastic housing.



**NEW IMAGE TO ACCELERATE TOMORROW**

IT'S TIME TO RIDE TOWARD THE FUTURE!



## SPI FUEL LINE - BLUE

- Made from polyurethane and designed to be flexible and durable, with good resistance to fuel and oil.
- Stays soft and pliable
- withstands temperatures to -65 degrees Fahrenheit,
- Exceptional resistance to gas and oil.

| 5' ROLL          |               |
|------------------|---------------|
| SIZES            | PART #        |
| 1/8" ID 5' ROLL  | <b>121315</b> |
| 3/16" ID 5' ROLL | <b>121318</b> |
| 1/4" ID 5' ROLL  | <b>121320</b> |

| 25' ROLL          |                 |
|-------------------|-----------------|
| SIZES             | PART #          |
| 3/16" ID 25' ROLL | <b>121316</b>   |
| 1/4" ID 25' ROLL  | <b>121319</b>   |
| 1/8" ID 25' ROLL  | <b>62-07010</b> |

| 50' ROLL          |                 |
|-------------------|-----------------|
| SIZES             | PART #          |
| 1/4" ID 50' ROLL  | <b>121322</b>   |
| 3/16" ID 50' ROLL | <b>62-07011</b> |
| 1/4" ID 50' ROLL  | <b>62-07012</b> |
| 7/32" ID 50' ROLL | <b>62-07013</b> |

| 100' ROLL          |               |
|--------------------|---------------|
| SIZES              | PART #        |
| 1/8" ID 100' ROLL  | <b>121314</b> |
| 3/16" ID 100' ROLL | <b>121317</b> |
| 1/4" ID 100' ROLL  | <b>121321</b> |
| 5/16" ID 100' ROLL | <b>121323</b> |

| 650' ROLL         |                 |
|-------------------|-----------------|
| SIZES             | PART #          |
| 1/8" ID 650' ROLL | <b>62-07050</b> |



### SPI IN-LINE FUEL FILTER W BRASS SCREEN 1 4"

- Fits a 1/4" fuel line
- Brass screen interior

**120302**



### SPI IN-LINE FUEL FILTER W/ STEEL SCREEN 5/16"

- Fits a 5/16" fuel line
- Stainless steel interior

**120303**



## SPI PVC FUEL LINE - CLEAR

- It is made of top-grade polyurethane, which is resistant to low temperatures.
- This fuel line allows for visual confirmation of fuel flow.
- The PVC material is top-grade and known for its flexibility, making it suitable for various applications, including lawn and garden equipment.

| 5' ROLL          |               |
|------------------|---------------|
| SIZES            | PART #        |
| 1/8" ID 5' ROLL  | <b>121326</b> |
| 3/16" ID 5' ROLL | <b>121329</b> |
| 1/4" ID 5' ROLL  | <b>121336</b> |

| 25' ROLL          |               |
|-------------------|---------------|
| SIZES             | PART #        |
| 1/8" ID 25' ROLL  | <b>121324</b> |
| 3/16" ID 25' ROLL | <b>121327</b> |
| 1/4" ID 25' ROLL  | <b>121331</b> |

| 50' ROLL          |               |
|-------------------|---------------|
| SIZES             | PART #        |
| 1/4" ID 50' ROLL  | <b>121330</b> |
| 5/16" ID 50' ROLL | <b>121333</b> |
| 7/32" ID 50' ROLL | <b>121335</b> |

| 100' ROLL          |               |
|--------------------|---------------|
| SIZES              | PART #        |
| 1/8" ID 100' ROLL  | <b>121325</b> |
| 3/16" ID 100' ROLL | <b>121328</b> |
| 1/4" ID 100' ROLL  | <b>121332</b> |
| 5/16" ID 100' ROLL | <b>121334</b> |



### FUEL LINE CLIP FOR 3/16" TUBINGS PACKAGE OF 10

- FUEL LINE CLIP FOR 3/16" TUBINGS
- PACKAGE OF 10

**127886**



### FUEL LINE CLIP FOR 1/4" TUBINGS PACKAGE OF 10

- FUEL LINE CLIP FOR 1/4" TUBINGS
- PACKAGE OF 10

**127887**



### UNIVERSAL FUEL CLAMPS

- A clamp that really works!
- Sold each

| SIZES | PART #      |
|-------|-------------|
| 3/16" | <b>5903</b> |
| 1/4"  | <b>5904</b> |
| 5/16" | <b>5905</b> |



### FUEL FILTER, IN-TANK FOR 3/8" ID FUEL LINE

- Fits all 5/16" fuel line
- No check valve

**121219**

## SPI Y FITTING



- A universal fuel line fitting.
- It's described as a plastic Y-fitting.
- This type of fitting is used in fuel systems to connect a fuel line to a fitting with multiple branches.

| SIZES    | PART#         |
|----------|---------------|
| 3/16 in. | <b>127259</b> |
| 1/4 in.  | <b>127260</b> |
| 3/8 in.  | <b>127261</b> |
| 5/16 in. | <b>127262</b> |

## SPI IN-LINE FUEL FILTER 7/32"



Is an inline fuel filter designed for use with 7/32" fuel lines. It is an in-line filter, meaning it is typically placed directly in the fuel line to filter out impurities.

**62-07014**

## SPI WALBRO TYPE IN-LINE FILTER



Walbro type in-line design, Orig. A greatly improved see thru filter with a larger fuel flow capacity.

| SIZES | PART #          |
|-------|-----------------|
| 1/4"  | <b>62-07019</b> |
| 5/16" | <b>62-07020</b> |

## SPI EXTRA LARGE IN-LINE FILTER 1/4"



- Designed for use with 1/4in. fuel lines.
- Easily installed by cutting the fuel line and inserting filter.

**LP07707**

## SPI UNIVERSAL AIR FILTER



Is a washable polyester filter with aluminum end caps. It is designed to fit 36-38mm carburetors. The filter has a 61mm inner diameter and a length of 92mm. It is also described as a tapered filter.

| SIZES                   | PART #        |
|-------------------------|---------------|
| Dai. 61MM - Length 92MM | <b>627047</b> |
| Dai. 71MM - Length 92MM | <b>627048</b> |

## SPI IN-TANK FILTER 1/4"



- Jumbo type in-tank fuel filter used by YAMAHA and others
- Universal application fits all gas tanks

**LP07708**



**SPI UNIVERSAL IN-LINE FUEL FILTER**



- Super in-line filter
- Inlet/outlet adaptable for both 7/32" and 1/4" ID fuel line

**KX072431**

**SPI UNIVERSAL IN-LINE FUEL FILTER**



- Inline filter works on 5/16" line.
- Used on many oil injected machines from '87-09.

**KX072462**

**SPI IN-LINE FUEL FILTER 1/4"**



- Sturdy nylon fuel filter. 11-12 gallons per hour capacity fuel flow.
- Nylon screen traps all dirt particles. 2in. Length

**LP07700**

**SPI PRIMER BULB ASSEMBLY**



Rubber bulb in-line type primer complete with built-in check valves can be installed anywhere along fuel line.

| SIZES | PART #          |
|-------|-----------------|
| 1/4"  | <b>LP077002</b> |
| 3/16" | <b>LP077003</b> |

**SPI SCREW-IN FILTER 1/4"**



- Screw-in base type fuel filter fits Tillotson & Walbro Carbs.

**LP07703**

**SPI EXTRA LARGE IN-LINE FILTER**



- Jumbo in-line nylon fuel filter
- The nylon screen has a self-cleaning action
- 4" long
- 2 sizes 3/16" or 1/4"
- Sold each (bulk)

| SIZES   | PART #          |
|---------|-----------------|
| (3/16") | <b>LP077063</b> |
| (1/4")  | <b>LP077064</b> |

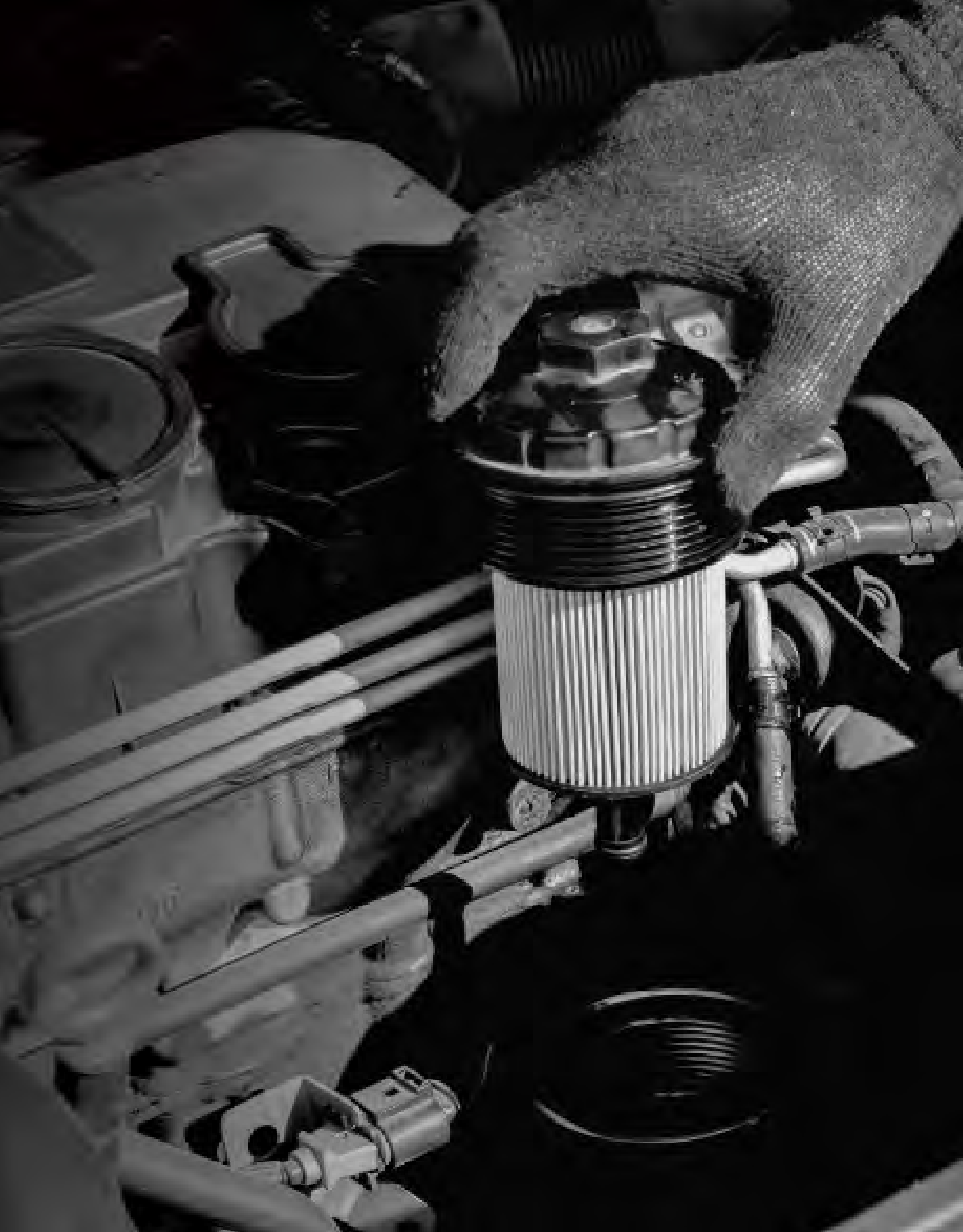



# TABLE OF CONTENTS

|                   |     |
|-------------------|-----|
| AIR FILTERS ..... | 538 |
| OIL FILTERS ..... | 539 |

# AIR FILTERS



please visit [autodist.com](http://autodist.com) to see selection

# OIL FILTERS



please visit [autodist.com](http://autodist.com) to see selection

# 1-9

# INDEX

|                                           |     |                                                    |     |                                              |     |
|-------------------------------------------|-----|----------------------------------------------------|-----|----------------------------------------------|-----|
| <b>1/2" Dr 15" Hex Handle</b>             |     | <b>104 Octane Boost</b>                            |     | <b>19 PC 3/8" Drive Black Socket Set</b>     |     |
| Performance Tool.....                     | 375 | Gold Eagle.....                                    | 202 | Performance Tool.....                        | 379 |
| <b>1/2" Dr Slick Torque Wrench</b>        |     | <b>11 PC Combination Wrench Set</b>                |     | <b>2 Cycle Super Techniplate Oil</b>         |     |
| Performance Tool.....                     | 405 | Performance Tool.....                              | 393 | Klotz.....                                   | 207 |
| <b>1/2" Drive Torque Wrench</b>           |     | <b>11 PC Connector Terminal Removal/Pin Puller</b> |     | <b>2 In 1 Led Light</b>                      |     |
| Performance Tool.....                     | 406 | RM Stator.....                                     | 417 | Performance Tool.....                        | 395 |
| <b>1/4" Dr Universal Joint</b>            |     | <b>12 PC Rail Hook Set</b>                         |     | <b>2 In 1 Wire Stripper/Crimper</b>          |     |
| Performance Tool.....                     | 376 | Performance Tool.....                              | 389 | Performance Tool.....                        | 387 |
| <b>1/4" Fuel Filter</b>                   |     | <b>12 PC Star Bit Socket Set</b>                   |     | <b>2 PC Flex Funnel</b>                      |     |
| Emgo.....                                 | 480 | Performance Tool.....                              | 406 | Performance Tool.....                        | 387 |
| <b>1/4" X 3/8" Adapter</b>                |     | <b>12" Flexible Hose</b>                           |     | <b>2 PC Led Pocket Flashlight</b>            |     |
| Performance Tool.....                     | 376 | Performance Tool.....                              | 386 | Performance Tool.....                        | 396 |
| <b>10 3/8" Dr SAE Socket Set</b>          |     | <b>12" Tool Bag</b>                                |     | <b>2 PC Pick Set</b>                         |     |
| Performance Tool.....                     | 407 | Performance Tool.....                              | 392 | Performance Tool.....                        | 401 |
| <b>10 Ft Extension Cable</b>              |     | <b>12.5 Ft Extension Lead</b>                      |     | <b>2 Ton Cable Power Puller</b>              |     |
| Noco.....                                 | 449 | Deltran.....                                       | 440 | Performance Tool.....                        | 398 |
| <b>10 PC 1/4" Dr Metric Socket Set</b>    |     | <b>120 PC Heat Shrink Tubing Set</b>               |     | <b>2 Ton Hydraulic Bottle Jack</b>           |     |
| Performance Tool.....                     | 406 | Performance Tool.....                              | 403 | Performance Tool.....                        | 381 |
| <b>10 PC 1/4" Dr SAE Socket Set</b>       |     | <b>120 PC Fuse Assortment</b>                      |     | <b>2 Ton Jack Stand</b>                      |     |
| Performance Tool.....                     | 407 | Performance Tool.....                              | 384 | Performance Tool.....                        | 382 |
| <b>10 PC 1/4" Drive Dw Socket Set</b>     |     | <b>120 PC Mini Fuse Assortment</b>                 |     | <b>2" Cup Wire Brush</b>                     |     |
| Performance Tool.....                     | 377 | Performance Tool.....                              | 384 | Performance Tool.....                        | 393 |
| <b>10 PC 1/4" Drive socket Set</b>        |     | <b>1200 PC Nut And Bolt Assortment</b>             |     | <b>200 PC Self Drilling Screws</b>           |     |
| Performance Tool.....                     | 377 | Performance Tool.....                              | 384 | Performance Tool.....                        | 384 |
| <b>10 PC 1/4" Drive Metric Socket Set</b> |     | <b>120V Led Work light</b>                         |     | <b>200 PC Spring Assortment</b>              |     |
| Performance Tool.....                     | 378 | Performance Tool.....                              | 407 | Performance Tool.....                        | 384 |
| <b>10 PC 3/8" Drive SAE Dw Socket</b>     |     | <b>12V Compact Tire Inflator</b>                   |     | <b>2000 Amp Lithium Boost Pack</b>           |     |
| Performance Tool.....                     | 378 | Performance Tool.....                              | 372 | Noco.....                                    | 448 |
| <b>10 PC Hex Bit Socket Set</b>           |     | <b>12V Plug Connector</b>                          |     | <b>2-1/2 Ton Garage Jack</b>                 |     |
| Performance Tool.....                     | 374 | Noco.....                                          | 449 | Performance Tool.....                        | 382 |
| <b>10 PC Impact Star Bit Socket Set</b>   |     | <b>13mm Ball Stud</b>                              |     | <b>22 PC SAE/Metric Ball End Hex Key Set</b> |     |
| Performance Tool.....                     | 391 | Suspa.....                                         | 423 | Performance Tool.....                        | 380 |
| <b>10 PC Metric Hex Bit Socket Set</b>    |     | <b>150 PC Cotter Pin Assortment</b>                |     | <b>24 Led Work Light</b>                     |     |
| Performance Tool.....                     | 374 | Performance Tool.....                              | 384 | Performance Tool.....                        | 396 |
| <b>10 PC T-Handle Key Set</b>             |     | <b>150 PC Hair Pin Assortment</b>                  |     | <b>25 Ft Extension Lead</b>                  |     |
| Performance Tool.....                     | 401 | Performance Tool.....                              | 384 | Deltran.....                                 | 440 |
| <b>10 PC X 3/8" Met Dw Socket Set</b>     |     | <b>150 PC Wing Nut Assortment</b>                  |     | <b>25' Orange Extension Chord</b>            |     |
| Performance Tool.....                     | 379 | Performance Tool.....                              | 384 | Performance Tool.....                        | 388 |
| <b>100 Amp Battery Load Tester</b>        |     | <b>1500 Amp Lithium Boost Pack</b>                 |     | <b>250 Amp Lithium Battery</b>               |     |
| Performance Tool.....                     | 389 | Noco.....                                          | 449 | Noco.....                                    | 443 |
| <b>100 PC Bit Set</b>                     |     | <b>16 Pack Hose Bender 1" O.D. Hose</b>            |     | <b>26 PC Hose Clamp Assortment</b>           |     |
| Performance Tool.....                     | 381 | Bronco.....                                        | 303 | Performance Tool.....                        | 384 |
| <b>100 PC Utility Knife Blades</b>        |     | <b>160 PC Wire Terminal Assortment</b>             |     | <b>26 PC Key Type Hose Clamp Assortment</b>  |     |
| Performance Tool.....                     | 390 | Performance Tool.....                              | 384 | Performance Tool.....                        | 390 |
| <b>1000 Amp Lithium Boost Pack</b>        |     | <b>16Oz Ball Pein Hammer</b>                       |     | <b>285 PC Electrical Repair Kit</b>          |     |
| Noco.....                                 | 448 | Performance Tool.....                              | 373 | Performance Tool.....                        | 384 |
|                                           |     | <b>18" Flexible Hose</b>                           |     | <b>29 PC. Drill Bit Set W/Steel Case</b>     |     |
|                                           |     | Performance Tool.....                              | 386 | Performance Tool.....                        | 383 |

|                                                     |                                             |                                              |
|-----------------------------------------------------|---------------------------------------------|----------------------------------------------|
| <b>2-Stroke Timing Kit For Water Cooled Engines</b> | <b>300V Factory Line Oil</b>                | <b>5 PC 1/2" Dr Thin Wall Sockets</b>        |
| Motion Pro ..... 350                                | Motul ..... 262                             | Performance Tool..... 391                    |
| <b>3 Gallon Motorsport Container</b>                | <b>303 Protectant</b>                       | <b>5 PC Sp Socket Set</b>                    |
| VP ..... 428                                        | Gold Eagle ..... 202                        | Performance Tool..... 374                    |
| <b>3 in 1 Flashlight</b>                            | <b>32" Bin Rail Set</b>                     | <b>5 PC Tapered Extractors</b>               |
| Performance Tool..... 389                           | Performance Tool..... 389                   | Performance Tool..... 385                    |
| <b>3 in 1 Stapler</b>                               | <b>347 PC SAE Nut &amp; Bolt Assortment</b> | <b>5.5 Gallon Motorsport Containers</b>      |
| Performance Tool..... 382                           | Performance Tool..... 384                   | VP ..... 426                                 |
| <b>3 PC 1/2" Dr Extension Set</b>                   | <b>347PC Metric Nut/Bolt Assortment</b>     | <b>5/16" Fuel Filter</b>                     |
| Performance Tool..... 375                           | Performance Tool..... 384                   | Emgo ..... 481                               |
| <b>3 PC 1/2" Dr Wobble Extension Set</b>            | <b>36 PC 1/4" Drive Mechanics Set</b>       | <b>50 PC Utility Knife Blades</b>            |
| Performance Tool..... 375                           | Performance Tool..... 377                   | Performance Tool..... 406                    |
| <b>3 PC 1/4" Drive Extension Set</b>                | <b>36mm Axle Socket For HD</b>              | <b>50:1 Techniplate Oil</b>                  |
| Performance Tool..... 377                           | Moton Pro ..... 330                         | Klotz..... 211                               |
| <b>3 PC 3/8" Drive Wobble Extension Set</b>         | <b>3-Jaw Puller</b>                         | <b>500 Amp Lithium Battery</b>               |
| Performance Tool..... 378                           | Performance Tool..... 405                   | Noco ..... 443                               |
| <b>3 PC Adjustable Wrench Set</b>                   | <b>4 Bank Battery Charger</b>               | <b>500 PC Rivet Assortment</b>               |
| Performance Tool..... 398                           | Deltran ..... 436-437                       | Performance Tool..... 384                    |
| <b>3 PC Inspection Tool Set</b>                     | <b>4 PC 3/8" Drive Extension Set</b>        | <b>51 PC 3/8" Drive Mechanic Set</b>         |
| Performance Tool..... 395                           | Performance Tool..... 377                   | Performance Tool..... 379                    |
| <b>3 PC Lock Grip Pliers Set</b>                    | <b>4" Grease Gun Needle Adapter</b>         | <b>510 2T Oil</b>                            |
| Performance Tool..... 373                           | Performance Tool..... 405                   | Motul ..... 262                              |
| <b>3 Pc Pry Bar Set</b>                             | <b>40 Inch 6-Caster Plastic Creeper</b>     | <b>5100 4T Oil</b>                           |
| Performance Tool..... 374                           | Performance Tool..... 383                   | Motul ..... 263                              |
| <b>3 PC. Step Drill Bit Set</b>                     | <b>400 Amp Lithium Battery</b>              | <b>560 PC Cotter Pin Assortment</b>          |
| Performance Tool..... 383                           | Noco ..... 443                              | Performance Tool..... 384                    |
| <b>3/8 X 1/2 M Adapter</b>                          | <b>400 Amp Lithium Boost Pack</b>           | <b>6 Ft Quick Disconnect Extension Cable</b> |
| Performance Tool ..... 375                          | Noco ..... 448                              | Deltran ..... 440                            |
| <b>3/8" Dr Deep Socket</b>                          | <b>4-1/2 Inch Angle Grinder</b>             | <b>6 Inch Digital Caliper</b>                |
| Performance Tool..... 402                           | Performance Tool..... 383                   | Performance Tool..... 385                    |
| <b>3/8" Dr Universal Joint</b>                      | <b>44mm Cr Bearing Retainer Tool</b>        | <b>6 Inch Plastic Caliper</b>                |
| Performance Tool..... 407                           | Motion Pro ..... 339                        | Performance Tool..... 383                    |
| <b>3/8" Impact Driver W/ Bits</b>                   | <b>47mm Cr Seal / Bearing Retainer Tool</b> | <b>6 Inch Quick Release C-Clamp</b>          |
| Performance Tool..... 397                           | Motion Pro ..... 339                        | Performance Tool..... 382                    |
| <b>3/8" X 1/2" Adapter</b>                          | <b>4Lb Sledge Hammer</b>                    | <b>6 PC Screwdriver Set</b>                  |
| Performance Tool..... 375                           | Performance Tool..... 373                   | Performance Tool..... 394                    |
| <b>3/8" X 1/4" Adapter</b>                          | <b>4-Stroke Motorcycle Oil</b>              | <b>6 Volt Batteries</b>                      |
| Performance Tool..... 378                           | Klotz..... 208                              | Yuasa..... 460                               |
| <b>3/8" X 5/8" Spark Plug Socket</b>                | <b>4T Fuel Additive</b>                     | <b>600 Amp Lithium Battery</b>               |
| Performance Tool..... 378                           | Liqui Moly..... 231                         | Noco ..... 444                               |
| <b>30 Pc Hex Key Wrench Set</b>                     | <b>4-Way Folding Lug Wrench</b>             | <b>61 PC Rivet Gun Set</b>                   |
| Performance Tool..... 380                           | Performance Tool..... 383                   | Performance Tool..... 395                    |
| <b>3000 Plus 4T Oil</b>                             | <b>5 Bank Battery Charger</b>               | <b>7 PC Bearing Race &amp; Seal Driver</b>   |
| Motul ..... 262                                     | Deltran ..... 437                           | Performance Tool..... 385                    |
| <b>300PC E-Clip Assortment</b>                      | <b>5 Gallon Air Tank</b>                    | <b>7 PC Chisel &amp; Punch Set</b>           |
| Performance Tool..... 384                           | Performance Tool..... 393                   | Performance Tool..... 380                    |
| <b>300PC Snap Ring Assortment</b>                   | <b>5 Gallon Pail Pump</b>                   | <b>7 PC Grease Gun Accessory Kit</b>         |
| Performance Tool..... 384                           | Maxima ..... 243                            | Performance Tool..... 385                    |
|                                                     | <b>5 in 1 Damper Rod Bleeder Tool</b>       | <b>7 PC Plier Set</b>                        |
|                                                     | Motion Pro ..... 331                        | Performance Tool..... 398                    |



|                                              |              |
|----------------------------------------------|--------------|
| AT12BS-HD Lithium Battery .....              | 470          |
| AT7B-BS Lithium Battery .....                | 469          |
| ATX12 Lithium Battery .....                  | 470          |
| ATX12-Ah Lithium Battery .....               | 470          |
| ATX12-HD Lithium Battery.....                | 470          |
| ATX20 Lithium Battery .....                  | 470          |
| ATX20-HD Lithium Battery.....                | 470          |
| ATX30 Lithium Battery .....                  | 470          |
| ATZ 10 Lithium Battery .....                 | 469          |
| ATZ 7 Lithium Battery .....                  | 469          |
| Lithium Batteries .....                      | 469-471      |
| Re-Start Lithium Batteries.....              | 469-471      |
| SC-1 Lithium Battery.....                    | 470          |
| <b>Antirust Spray</b>                        |              |
| Motorex.....                                 | 259          |
| <b>Anti-Seize</b>                            |              |
| Permatex .....                               | 273          |
| <b>Asphalt Drag Racing Track</b>             |              |
| Camso .....                                  | 169          |
| <b>Assembly Grease</b>                       |              |
| Maxima .....                                 | 241          |
| <b>Assembly Lube</b>                         |              |
| Klotz.....                                   | 210          |
| Maxima .....                                 | 241          |
| <b>AT12BS Lithium Battery</b>                |              |
| Antigravity Batteries.....                   | 469          |
| <b>AT12BS-HD Lithium Battery</b>             |              |
| Antigravity Batteries.....                   | 470          |
| <b>AT7B-BS Lithium Battery</b>               |              |
| Antigravity Batteries.....                   | 469          |
| ATF Dextron 3.....                           |              |
| Motorex.....                                 | 252          |
| <b>ATF Super</b>                             |              |
| Motorex.....                                 | 253          |
| <b>ATV 4T Motor Oil</b>                      |              |
| Liqui Moly.....                              | 224          |
| <b>ATV Axle Wrench Set 45.5mm &amp; 56mm</b> |              |
| Motion Pro .....                             | 353          |
| <b>ATV Quad 4T Oil</b>                       |              |
| Motorex.....                                 | 251          |
| <b>ATV/UTV Engine Oil</b>                    |              |
| Klotz.....                                   | 212-213, 217 |
| <b>ATV/UTV Wash</b>                          |              |
| Liquid Performance.....                      | 223          |
| <b>ATX12 Lithium Battery</b>                 |              |
| Antigravity Batteries.....                   | 470          |
| <b>ATX12-Ah Lithium Battery</b>              |              |
| Antigravity Batteries.....                   | 470          |

|                                             |     |
|---------------------------------------------|-----|
| <b>ATX12-HD Lithium Battery</b>             |     |
| Antigravity Batteries.....                  | 470 |
| <b>ATX20 Lithium Battery</b>                |     |
| Antigravity Batteries.....                  | 470 |
| <b>ATX20-HD Lithium Battery</b>             |     |
| Antigravity Batteries.....                  | 470 |
| <b>ATX30 Lithium Battery</b>                |     |
| Antigravity Batteries.....                  | 470 |
| <b>ATZ 10 Lithium Battery</b>               |     |
| Antigravity Batteries.....                  | 469 |
| <b>ATZ 7 Lithium Battery</b>                |     |
| Antigravity Batteries.....                  | 469 |
| <b>Automatic IP65 Smart Battery Charger</b> |     |
| RM Stator.....                              | 417 |
| <b>Automatic Wire Strippers</b>             |     |
| Performance Tool.....                       | 395 |
| <b>Auxiliary Tank</b>                       |     |
| Motion Pro .....                            | 342 |

## B

|                                    |          |
|------------------------------------|----------|
| <b>Back Country X-XC Track</b>     |          |
| Camso .....                        | 172      |
| <b>Baffle Plate</b>                |          |
| Keihin.....                        | 497      |
| <b>Balanced Tubes</b>              |          |
| Counteract .....                   | 184      |
| <b>Balancing Beads</b>             |          |
| Counteract .....                   | 306-307  |
| <b>Ball End Allen Set</b>          |          |
| Motion Pro .....                   | 333      |
| <b>Bar Stool With Swivel Seat</b>  |          |
| Performance Tool.....              | 401      |
| <b>Barbed Fitting Brass</b>        |          |
| Motion Pro .....                   | 530      |
| <b>Barrel Nipple</b>               |          |
| Motion Pro .....                   | 357-358  |
| <b>Battery Acid</b>                |          |
| Tytaneum.....                      | 451      |
| Yuasa.....                         | 467      |
| <b>Battery Alternator Tester</b>   |          |
| Performance Tool.....              | 389      |
| <b>Battery Bolt</b>                |          |
| Yuasa.....                         | 467      |
| <b>Battery Cable Crimping Tool</b> |          |
| All Balls.....                     | 300, 474 |

|                                       |         |
|---------------------------------------|---------|
| <b>Battery Cables</b>                 |         |
| All Balls.....                        | 473     |
| <b>Battery Chargers</b>               |         |
| Deltran .....                         | 434-437 |
| Yuasa.....                            | 466     |
| <b>Battery Clamp Connector</b>        |         |
| Noco .....                            | 449     |
| <b>Battery Cleaner</b>                |         |
| Permatex .....                        | 274     |
| <b>Battery Cross Reference Chart</b>  |         |
| Tytaneum.....                         | 454-455 |
| Yuasa.....                            | 461-462 |
| <b>Battery Designation Chat</b>       |         |
| Yuasa.....                            | 456     |
| <b>Battery Hardware</b>               |         |
| Yuasa.....                            | 467     |
| <b>Battery Isolator Kit</b>           |         |
| All Balls.....                        | 300     |
| <b>Battery Maintainer</b>             |         |
| Deltran .....                         | 434-436 |
| Yuasa.....                            | 466     |
| <b>Battery Operated Transfer Pump</b> |         |
| Performance Tool.....                 | 392     |
| <b>Battery Specification Chart</b>    |         |
| Yuasa.....                            | 463-465 |
| <b>Battery Tender Case</b>            |         |
| Deltran .....                         | 441     |
| <b>Battery Tender Junior</b>          |         |
| Deltran .....                         | 434     |
| <b>Battery Tender Plus</b>            |         |
| Deltran .....                         | 434-435 |
| <b>Battery Tender Plus 3 Amp</b>      |         |
| Deltran .....                         | 435     |
| <b>Battery Tender Plus 4 Amp</b>      |         |
| Deltran .....                         | 435     |
| <b>Battery Tender Plus 5 Amp</b>      |         |
| Deltran .....                         | 435     |
| <b>Battery Tender Power Tender</b>    |         |
| Deltran .....                         | 436     |
| <b>Battery Terminal</b>               |         |
| All Balls.....                        | 474     |
| <b>Battery Terminal Brush</b>         |         |
| Performance Tool.....                 | 394     |
| <b>Battlax Adventure A41</b>          |         |
| Bridgestone.....                      | 65      |

# INDEX

|                                                |                                   |                                             |
|------------------------------------------------|-----------------------------------|---------------------------------------------|
| <b>Battlax Adventure AX41</b>                  | <b>Battlax TH01</b>               | <b>Bikebrite</b>                            |
| Bridgestone..... 67                            | Bridgestone..... 27               | Blue Buster ..... 196                       |
| <b>Battlax Adventure cross Scrambler AX41S</b> | <b>Battle Wing BW-501/BW-502</b>  | Drying Cloth ..... 196                      |
| Bridgestone..... 68                            | Bridgestone..... 68               | Micro Fiber Cloth ..... 196                 |
| <b>Battlax Adventure Trail AT41</b>            | <b>Battlecross E50</b>            | Moto Glaze ..... 196                        |
| Bridgestone..... 66                            | Bridgestone..... 64               | Moto Mask Display ..... 196                 |
| <b>Battlax BT011</b>                           | <b>Battlecross E50 Extreme</b>    | Moto Mask Off ..... 196                     |
| Bridgestone..... 27                            | Bridgestone..... 65               | Moto Mask On ..... 196                      |
| <b>Battlax BT012</b>                           | <b>Battlecross X10</b>            | Moto Mask Windscreen ..... 196              |
| Bridgestone..... 27                            | Bridgestone..... 62               | Retail Rack ..... 196                       |
| <b>Battlax BT020</b>                           | <b>Battlecross X20</b>            | <b>Bilge Cleaner</b>                        |
| Bridgestone..... 28                            | Bridgestone..... 63               | Bio-Kleen ..... 198                         |
| <b>Battlax BT023</b>                           | <b>Battlecross X30</b>            | <b>Bio Air Filter Cleaner</b>               |
| Bridgestone..... 28                            | Bridgestone..... 63               | Twin Air ..... 296                          |
| <b>Battlax BT028</b>                           | <b>Battlecross X31</b>            | <b>Bio Air Filter Oil</b>                   |
| Bridgestone..... 28                            | Bridgestone..... 61               | Twin Air ..... 296                          |
| <b>Battlax BT45</b>                            | <b>Battlecross X40</b>            | <b>Bio foam</b>                             |
| Bridgestone..... 21                            | Bridgestone..... 64               | Maxima ..... 243                            |
| <b>Battlax BT46</b>                            | <b>Bead Buddy</b>                 | <b>Bio Wash</b>                             |
| Bridgestone..... 20                            | Motion Pro ..... 344              | Maxima ..... 241                            |
| <b>Battlax BT54</b>                            | <b>Beadbuster</b>                 | <b>Bio-Kleen</b>                            |
| Bridgestone..... 27                            | XB-455 Tire Bead Breaker..... 301 | Aluma Kleen ..... 198                       |
| <b>Battlax H50</b>                             | <b>Beadlock Spacer UTV Spacer</b> | Amazing Armor ..... 197                     |
| Bridgestone..... 17                            | Raceline ..... 153                | Amazing Cleaner ..... 197                   |
| <b>Battlax Rs10</b>                            | <b>Bearing Driver</b>             | Bike Magik Degreaser ..... 197              |
| Bridgestone..... 10                            | Motion Pro ..... 322              | Bilge Cleaner ..... 198                     |
| <b>Battlax Rs11</b>                            | <b>Bearing Packer</b>             | Fiberglass Cleaner..... 197                 |
| Bridgestone..... 9                             | Performance Tool..... 386         | Leather, Vinyl, Fabric ..... 197            |
| <b>Battlax S21</b>                             | <b>Bearing Remover</b>            | Metal Polish ..... 197                      |
| Bridgestone..... 13                            | Motion Pro ..... 325              | Oxidation Remover ..... 198                 |
| <b>Battlax S22</b>                             | <b>Belt Tension Gauge</b>         | Qwik Shine..... 198                         |
| Bridgestone..... 12                            | Motion Pro ..... 323              | Remove All..... 198                         |
| <b>Battlax S23</b>                             | <b>Benol 2 Cycle Oil</b>          | Renew..... 197                              |
| Bridgestone..... 11                            | Klotz..... 208                    | Restore & Shine XTra Cut ..... 198          |
| <b>Battlax SC</b>                              | <b>Big Block K784</b>             | Salt Kleen ..... 198                        |
| Bridgestone..... 22                            | Kenda ..... 47                    | Sledbrite Krystal View ..... 197            |
| <b>Battlax SC2</b>                             | <b>Bighorn 2.0</b>                | Super Suds Wash ..... 198                   |
| Bridgestone..... 24                            | Maxxis..... 138                   | Wheel Gel..... 198                          |
| <b>Battlax SC2 Rain</b>                        | <b>Bighorn 3.0</b>                | <b>Bit Set (4)</b>                          |
| Bridgestone..... 23                            | Maxxis..... 139                   | Emgo ..... 308                              |
| <b>Battlax T31</b>                             | <b>Bighorn Radial</b>             | <b>Black Hose Bender- Utility Jug Spout</b> |
| Bridgestone..... 16                            | Maxxis..... 138                   | Risk..... 411                               |
| <b>Battlax T32</b>                             | <b>Bike Magik Degreaser</b>       | <b>Black Tubing</b>                         |
| Bridgestone..... 15                            | Bio-Kleen ..... 197               | Helix Racing..... 489                       |
| <b>Battlax T33</b>                             | <b>Bike SPLrits</b>               |                                             |
| Bridgestone..... 14                            | Spray Cleaner..... 272            |                                             |

|                                       |                                   |    |                                      |         |
|---------------------------------------|-----------------------------------|----|--------------------------------------|---------|
| <b>Blackwater Evolution</b>           | Battlax Adventure Trail AT41..... | 66 | M403/M404.....                       | 71      |
| ITP.....                              | Battlax BT011.....                | 27 | M59.....                             | 62      |
| <b>Blind Bearing Remover Kit</b>      | Battlax BT012.....                | 27 | Mag.Mopus G548R.....                 | 29      |
| Motion Pro.....                       | Battlax BT020.....                | 28 | Mag.Mopus L303.....                  | 29      |
| <b>Blue Buster</b>                    | Battlax BT023.....                | 28 | Mag.Mopus L309.....                  | 29      |
| Bikebrite.....                        | Battlax BT028.....                | 28 | MI16.....                            | 29      |
| <b>Blue Label Chain Lube</b>          | Battlax BT45.....                 | 21 | MI17.....                            | 29      |
| PJ1.....                              | Battlax BT46.....                 | 20 | Motorcycle Tubes.....                | 180-181 |
| <b>Blue Tubing</b>                    | Battlax BT54.....                 | 27 | Scooter Tires.....                   | 22-24   |
| Helix Racing.....                     | Battlax H50.....                  | 17 | Street tires.....                    | 9-29    |
| <b>Boost Max Batter Clamps</b>        | Battlax RS10.....                 | 10 | Tire Conversion Chart.....           | 30      |
| Noco.....                             | Battlax RS11.....                 | 9  | Tires.....                           | 9-30    |
| <b>Boost Max HD Battery Clamp</b>     | Battlax S21.....                  | 13 | Tires.....                           | 61-73   |
| Noco.....                             | Battlax S22.....                  | 12 | Trail Wing.....                      | 67      |
| <b>Boost Max Lithium Jump Starter</b> | Battlax S23.....                  | 11 | Trail Wing.....                      | 69      |
| Noco.....                             | Battlax SC.....                   | 22 | Trail Wing TW101/TW152.....          | 72      |
| <b>Boot &amp; Shoe Brush</b>          | Battlax SC2.....                  | 24 | Trail Wing TW2.....                  | 69      |
| Performance Tool.....                 | Battlax SC2 Rain.....             | 23 | Trail Wing TW301.....                | 25      |
| <b>Boxer 4T Oil</b>                   | Battlax T31.....                  | 16 | Trail Wing TW301/TW302.....          | 72      |
| Motorex.....                          | Battlax T32.....                  | 15 | Trail Wing TW302.....                | 25      |
| <b>BPF Rod Guide Wrench</b>           | Battlax T33.....                  | 14 | Trail Wing TW31.....                 | 73      |
| Motion Pro.....                       | Battlax TH01.....                 | 27 | Trail Wing TW34.....                 | 73      |
| <b>Braided Vinyl Fuel Line</b>        | Battle Wing BW-501/BW-502.....    | 68 | Trail Wing TW42.....                 | 69      |
| Motion Pro.....                       | Battlecross E50.....              | 64 | Trail Wing TW42.....                 | 73      |
| <b>Brake Cleaner</b>                  | Battlecross E50 Extreme.....      | 65 | Trail Wing TW52.....                 | 73      |
| Motorex.....                          | Battlecross X10.....              | 62 | Trail Wing TW52.....                 | 73      |
| Permatex.....                         | Battlecross X20.....              | 63 | Trail Wing TW9.....                  | 73      |
| PJ1.....                              | Battlecross X30.....              | 63 | Tubes.....                           | 180-181 |
| <b>Brake Fluid</b>                    | Battlecross X31.....              | 61 | <b>Bridgestone</b>                   |         |
| Maxima.....                           | Battlecross X40.....              | 64 | Bridgestone Tires.....               | 61-73   |
| <b>Motorex 257</b>                    | Exedra G701.....                  | 18 | Trail Wing TW18.....                 | 72      |
| Motul.....                            | Exedra G702.....                  | 18 | <b>Bridgestone Tires</b>             |         |
| <b>Brass Idle Adjuster</b>            | Exedra G704.....                  | 18 | Bridgestone.....                     | 61-73   |
| Keihin.....                           | Exedra G709.....                  | 18 | <b>Bronco</b>                        |         |
| <b>Break Caliper Piston Tool</b>      | Exedra G850.....                  | 19 | 16 Pack Hose Bender 1" O.D. Hose303  |         |
| Motion Pro.....                       | Exedra G851.....                  | 19 | CV Boot Banding Tool.....            | 302     |
| <b>Break In Oil</b>                   | Exedra G852.....                  | 18 | CV Boot Banding Tool Ratchet Type302 |         |
| Maxima.....                           | Exedra G853.....                  | 18 | CV Boot Clamp Kit W/Tool.....        | 302     |
| <b>Break-Away Utility Knife</b>       | Exedra Max.....                   | 19 | CV Boot Clamp Pliers.....            | 302     |
| Performance Tool.....                 | Hoop B01.....                     | 25 | CV Boot Grease Pack.....             | 302     |
| <b>Bridgestone</b>                    | Hoop B02.....                     | 26 | CV Tools.....                        | 302     |
| Battlax Adventure A41.....            | Hoop B03.....                     | 26 | Cylinder Hones.....                  | 303     |
| Battlax Adventure AX41.....           | M203/M204.....                    | 70 | Cylinder Honing Brushes.....         | 303     |
| Battlax Adventure cross Scrambler     | M22/M23.....                      | 70 | Hose Benders.....                    | 303     |
| AX41S.....                            | M40.....                          | 71 | S.S. CV Boot Clamp 10".....          | 302     |

## Butterfly Carburetor Rebuild Kit

Vertex..... 484

# C

### C1 Chain Clean

Motul ..... 266

### C5 Chain Paste

Motul ..... 266

### Cable Adjust 32-28mm

Mikuni ..... 525

### Cable Adjuster

Motion Pro ..... 354

### Cable Adjuster Nut

Keihin ..... 490

### Cable Ball Fittings

Motion Pro ..... 358

### Cable Connector

Mikuni ..... 526

### Cable Holder

Keihin ..... 491

### Cable Housing Black 50' 5mm,6mm,7mm

Motion Pro ..... 359

### Cable Lube

Motion Pro ..... 247

PJ1 ..... 279

### Cable Tie Assortment 1000Pc

Performance Tool ..... 397

### Cable Tie Assortment 250Pc

Performance Tool ..... 397

### Cable Ties

Performance Tool ..... 382

SPI ..... 420

### Caliber

Caliber Tools ..... 304-305

Flex & Fold Funnel 3 Pc. Bundle .... 304

Flex & Fold Funnel Large ..... 304

Flex & Fold Funnel Medium ..... 304

Flex & Fold Funnel Small ..... 304

Funnels ..... 304

Hardware Kits ..... 305

Moving Equipment ..... 305

MR20K Wheel Chocks ..... 305

Multi-Grip Screw 33/Pack ..... 305

Multi-Grip Screw 8/Pack ..... 305

Pivot Pro Universal Dolly ..... 305

Rover 360 Snowmobile Casters ..... 305

Sled wheels ..... 305

Slydz-On ..... 199

### Caliber Tools

Caliber ..... 304-305

### Camso

Asphalt Drag Racing Track ..... 169

Back Country X2 XC Track ..... 173

Back Country XC Track ..... 172

Back Country X-XC Track ..... 172

Camso ..... 163-177

Carve Trail Track ..... 165

Challenger 250L Track ..... 176

Challenger 250LX Track ..... 176

Challenger 300LX Track ..... 176

Challenger Extreme Mtn. Track ..... 163

Challenger Extreme X Track ..... 177

Challenger Mountain Track ..... 163

Challenger Trail XC Track ..... 166

Challenger X3 Mountain Track ..... 171

Cobra 1.6 XC Track ..... 173

Cobra Swt Utility Track ..... 173

Cobra Trail Track ..... 165

Conquer 260 Mountain Track ..... 175

Conquer 280 Mountain Track ..... 174

Crossover XC Track ..... 165

Durasport 530 Trail Track ..... 167

Durasport 725 Trail Track ..... 167

Epic 280 Mountain Track ..... 175

Explore 725 Utility Track ..... 169

Freeride XC Track ..... 166

Grass/Ice Drag Racing Track ..... 170

Hacksaw Trail Track ..... 163

Hurricane 175 XC Track ..... 175

Ice Arrowhead 130 Track ..... 177

Ice Attack Trail Track ..... 164

Ice Attack XT Trail Track ..... 164

Ice Cobra 1.6 XC Track ..... 172

Ice Oval/Lemans Racing Track ..... 170

Ice Storm 150 Trail Track ..... 174

Ice Widetrack Utility Track ..... 169

Intense XC Track ..... 166

Peak 2.5 Mountain Track ..... 170

Ripsaw Full Utility Track ..... 168

Ripsaw II Trail Track ..... 168

Ripsaw II XC Track ..... 168

Ripsaw Trail Track ..... 164

Storm 150 Trail Track ..... 174

Track Clip ..... 177

### Camso

Camso ..... 163-177

### Candle

Klotz ..... 215

Klotz ..... 221

### Cap Cable Adjuster

Keihin ..... 494

### Carbon And Gasket Scraper

Performance Tool ..... 395

### Carburetor & Choke Cleaner

PJ1 ..... 278

Sta-Bil ..... 285

### Carburetor Adapter Top

Motion Pro ..... 367

### Carburetor Adjuster Screw

Motion Pro ..... 354

### Carburetor Angle Adjuster

Motion Pro ..... 359

### Carburetor Cable Adjuster

Keihin ..... 491

### Carburetor Cleaner

Motorex ..... 260

### Carburetor Conversion Kit

..... 484

### Carburetor End Nipple

Motion Pro ..... 357

### Carburetor Jets

EBC ..... 482-486

Keihin ..... 497

### Carburetor Mc

Mikuni ..... 519

### Carburetor Plate

Mikuni ..... 520

### Carburetor Tool 90 Degree W/Bits

Motion Pro ..... 321

### Carburetor Top (Vm34/28/29)

Mikuni ..... 523

### Carburetor Top Cap

Keihin ..... 490

|                                                 |     |                                      |         |                                                 |         |
|-------------------------------------------------|-----|--------------------------------------|---------|-------------------------------------------------|---------|
| <b>Carburetor Tuner Brash Adapters 5mm, 6mm</b> |     | <b>Chain Case Oil</b>                |         | <b>Chrome Fuel Filter</b>                       |         |
| Motion Pro .....                                | 368 | Klotz .....                          | 215     | Emgo .....                                      | 480-481 |
| <b>Carburetors</b>                              |     | <b>Chain Clean Degreaser</b>         |         | <b>Cigarette Lighter Adaptor</b>                |         |
| Mikuni .....                                    | 504 | Motorex .....                        | 261     | Deltran .....                                   | 441     |
| <b>Carded Fuel Filter</b>                       |     | <b>Chain Guard</b>                   |         | <b>Clamshell Prop</b>                           |         |
| Emgo .....                                      | 480 | Maxima .....                         | 242     | Suspa .....                                     | 423     |
| <b>Carlisle</b>                                 |     | <b>Chain Lube</b>                    |         | <b>Classic Spoke Wrench 5.0 / 7.0mm</b>         |         |
| Carlisle Hole Painted                           |     | Klotz .....                          | 213     | Motion Pro .....                                | 328     |
| White Spoked .....                              | 157 | Liqui Moly .....                     | 234     | <b>Classic Spoke Wrench 6/6.3mm / 6.5/6.9mm</b> |         |
| Universal Group Trailer                         |     | Motorex .....                        | 259-260 | Motion Pro .....                                | 332     |
| Wheel Hub Kits .....                            | 157 | Permatex .....                       | 274     | <b>Classic Spoke Wrench Set</b>                 |         |
| <b>Carlisle Hole Painted White Spoked</b>       |     | <b>Chain Pocket Saw</b>              |         | Motion Pro .....                                | 366     |
| Carlisle .....                                  | 157 | SPI .....                            | 421     | <b>Claw &amp; Magnetic Retriever</b>            |         |
| <b>Carlstar</b>                                 |     | <b>Chain Tension Hardware Kit</b>    |         | Performance Tool .....                          | 393     |
| Tubes .....                                     | 182 | Motion Pro .....                     | 346     | <b>Cleaning Tub</b>                             |         |
| <b>Carnage</b>                                  |     | <b>Chain Wax Care Kit</b>            |         | Twin Air .....                                  | 295     |
| Maxxis .....                                    | 140 | Maxima .....                         | 242     | <b>Cleanup</b>                                  |         |
| <b>Carnauba Past Wax</b>                        |     | <b>Chaincase Oil</b>                 |         | Maxima .....                                    | 241     |
| S100 .....                                      | 282 | Maxima .....                         | 240     | <b>Clear Plastic Bin Dividers</b>               |         |
| <b>Carnivore</b>                                |     | <b>Challenger 250L Track</b>         |         | Performance Tool .....                          | 390     |
| Maxxis .....                                    | 139 | Camso .....                          | 176     | <b>Clear PVC Vent Hose</b>                      |         |
| <b>Carnivore RT</b>                             |     | <b>Challenger 250LX Track</b>        |         | Motion Pro .....                                | 528     |
| Maxxis .....                                    | 139 | Camso .....                          | 176     | <b>Clear Tubing</b>                             |         |
| <b>Carve Trail Track</b>                        |     | <b>Challenger 300LX Track</b>        |         | Helix Racing .....                              | 489     |
| Camso .....                                     | 165 | Camso .....                          | 176     | <b>Clip Main Jet</b>                            |         |
| <b>Cataclysm K6702</b>                          |     | <b>Challenger Extreme Mtn.Track</b>  |         | Mikuni .....                                    | 525     |
| Kenda .....                                     | 41  | Camso .....                          | 163     | <b>Clip-On Handle-Bar Alignment Tool</b>        |         |
| <b>Ceros</b>                                    |     | <b>Challenger Extreme X Track</b>    |         | Motion Pro .....                                | 357     |
| Maxxis .....                                    | 142 | Camso .....                          | 177     | <b>Clutch Holding Tool</b>                      |         |
| <b>Chain Alignment Tool</b>                     |     | <b>Challenger K657</b>               |         | Motion Pro .....                                | 346     |
| Motion Pro .....                                | 344 | Kenda .....                          | 43      | <b>Clutch Tuner 2T Gear Oil</b>                 |         |
| <b>Chain Breaker</b>                            |     | <b>Challenger Mountain Track</b>     |         | PJ1 .....                                       | 277     |
| Emgo .....                                      | 308 | Camso .....                          | 163     | <b>Cobra 1.6 XC Track</b>                       |         |
| <b>Chain Breaker &amp; Riveting Tool</b>        |     | <b>Challenger Trail XC Track</b>     |         | Camso .....                                     | 173     |
| Motion Pro .....                                | 344 | Camso .....                          | 166     | <b>Cobra Swt Utility Track</b>                  |         |
| <b>Chain Breaker With Folding Handle</b>        |     | <b>Challenger X3 Mountain Track</b>  |         | Camso .....                                     | 173     |
| Motion Pro .....                                | 344 | Camso .....                          | 171     | <b>Cobra Trail Track</b>                        |         |
| <b>Chain Breaker, Press And Riveting Tool</b>   |     | <b>Channel Lock Pliers</b>           |         | Camso .....                                     | 165     |
| Motion Pro .....                                | 343 | Performance Tool .....               | 373     | <b>Collar</b>                                   |         |
| <b>Chain Brush</b>                              |     | <b>Choke Conversion Kit</b>          |         | Keihin .....                                    | 492     |
| Motion Pro .....                                | 345 | SPI .....                            | 484     | <b>Combo Fingernail Brush W/Magnet</b>          |         |
| <b>Chain Care Lube</b>                          |     | <b>Chrome &amp; Stainless Polish</b> |         | Performance Tool .....                          | 381     |
| Motul .....                                     | 267 | Starbrite .....                      | 290     | <b>Combo Metric Tool</b>                        |         |
|                                                 |     | <b>Chrome Cap</b>                    |         | Motion Pro .....                                | 352     |
|                                                 |     | ITP .....                            | 124     |                                                 |         |

|                                                                 |     |                                              |         |                                                                     |         |
|-----------------------------------------------------------------|-----|----------------------------------------------|---------|---------------------------------------------------------------------|---------|
| <b>Combo Y-Drive Wrench</b>                                     |     | <b>Continental</b>                           |         | <b>Corrosion Block Grease</b>                                       |         |
| Motion Pro .....                                                | 328 | Conti Attack SM Evo .....                    | 36      | Lear.....                                                           | 222     |
| <b>Compression Adjuster</b>                                     |     | Conti Attack SM2 .....                       | 34      | <b>Counter Act Diy Shop Pack 4</b>                                  |         |
| Motion Pro .....                                                | 338 | Conti Classic Attack.....                    | 39      | Counteract .....                                                    | 307     |
| <b>Compression Bolt Removal Tool For Wp<br/>4860 Mxma Cc</b>    |     | Conti Motion.....                            | 35      | <b>Counter Balancer &amp; Clutch Hub Spanner<br/>For Honda 20mm</b> |         |
| Motion Pro .....                                                | 324 | Conti Race Attack 2 Street.....              | 36      | Motion Pro .....                                                    | 347     |
| <b>Compression Tester</b>                                       |     | Conti Road.....                              | 35      | <b>Counter Shaft Seal Puller</b>                                    |         |
| Performance Tool.....                                           | 385 | Conti Road Attack 4 .....                    | 34      | Motion Pro .....                                                    | 331     |
| <b>Compression Tester With 10mm, 12mm<br/>And 14mm Adapters</b> |     | Conti Sport Attack.....                      | 33      | <b>Counteract</b>                                                   |         |
| Motion Pro .....                                                | 337 | Conti Sport Attack 4.....                    | 33      | Balanced Tubes.....                                                 | 184     |
| <b>Connector Kit</b>                                            |     | Conti Trail Attack 3.....                    | 37      | Tubes.....                                                          | 184     |
| RM Stator.....                                                  | 416 | TKC 70.....                                  | 37      | <b>Counteract</b>                                                   |         |
| <b>Conquer 260 Mountain Track</b>                               |     | TKC 70 Rocks.....                            | 38      | Balancing Beads .....                                               | 306-307 |
| Camso .....                                                     | 175 | TKC 80 Twin Duro .....                       | 38      | Counter Act Diy Shop Pack 4 .....                                   | 307     |
| <b>Conquer 280 Mountain Track</b>                               |     | <b>Conventional Batteries</b>                |         | Counteract Diy Kits .....                                           | 306     |
| Camso .....                                                     | 174 | Tytaneum.....                                | 453     | Shop Packs.....                                                     | 307     |
| <b>Contact Cleaner</b>                                          |     | Yuasa.....                                   | 459-460 | <b>Counteract Diy Kits</b>                                          |         |
| Klotz.....                                                      | 209 | <b>Conversion Kit</b>                        |         | Counteract .....                                                    | 306     |
| Maxima .....                                                    | 241 | Mikuni .....                                 | 527     | <b>Cover Screw</b>                                                  |         |
| PJ1.....                                                        | 278 | <b>Cool-Aide Concentrate</b>                 |         | Keihin.....                                                         | 490     |
| <b>Contact Grease</b>                                           |     | Maxima .....                                 | 246     | <b>Coyote</b>                                                       |         |
| Lubrimatic .....                                                | 236 | <b>Cool-Aide Coolant</b>                     |         | ITP .....                                                           | 118     |
| <b>Container Cap</b>                                            |     | Maxima .....                                 | 240-246 | <b>Crankcase Splitter V2</b>                                        |         |
| VP.....                                                         | 427 | <b>Coolanol</b>                              |         | Motion Pro .....                                                    | 355     |
| <b>Conti Attack SM Evo</b>                                      |     | Maxima .....                                 | 243     | <b>Crankshaft Puller</b>                                            |         |
| Continental.....                                                | 36  | <b>Coolant</b>                               |         | Motion Pro .....                                                    | 330     |
| <b>Conti Attack SM2</b>                                         |     | Engine Ice.....                              | 200     | <b>Cross Point 1/4" Hex-Drive Bit, Size No 1</b>                    |         |
| Continental.....                                                | 34  | Motorex.....                                 | 256     | Motion Pro .....                                                    | 357     |
| <b>Conti Classic Attack</b>                                     |     | <b>Coolant Flush</b>                         |         | <b>Cross Power 4T Oil</b>                                           |         |
| Continental.....                                                | 39  | Engine Ice.....                              | 200     | Motorex.....                                                        | 250     |
| <b>Conti Motion</b>                                             |     | <b>Coolant Recovery Tank 275cc</b>           |         | <b>Crossover XC Track</b>                                           |         |
| Continental.....                                                | 35  | Motion Pro .....                             | 347     | Camso .....                                                         | 165     |
| <b>Conti Race Attack 2 Street</b>                               |     | <b>Cooling System Tester, Type A</b>         |         | <b>Cruiser K671</b>                                                 |         |
| Continental.....                                                | 36  | Motion Pro .....                             | 337     | Kenda .....                                                         | 46      |
| <b>Conti Road</b>                                               |     | <b>Cooling System Tester, Type A Adapter</b> |         | <b>Crytid</b>                                                       |         |
| Continental.....                                                | 35  | Motion Pro .....                             | 345     | ITP .....                                                           | 119     |
| <b>Conti Road Attack 4</b>                                      |     | <b>Copper Paste</b>                          |         | <b>Cup Type Oil Filter Wrench</b>                                   |         |
| Continental.....                                                | 34  | Motorex.....                                 | 255     | Emgo .....                                                          | 308     |
| <b>Conti Sport Attack</b>                                       |     | <b>Copper Spray</b>                          |         | <b>CV Boot Banding Tool</b>                                         |         |
| Continental.....                                                | 33  | Motorex.....                                 | 261     | Bronco .....                                                        | 302     |
| <b>Conti Sport Attack 4</b>                                     |     | <b>Coronado</b>                              |         | <b>CV Boot Banding Tool Ratchet Type</b>                            |         |
| Continental.....                                                | 33  | Maxxis.....                                  | 142     | Bronco .....                                                        | 302     |
| <b>Conti Trail Attack 3</b>                                     |     | <b>Corrosion Block</b>                       |         | <b>CV Boot Clamp Kit W/Tool</b>                                     |         |
| Continental.....                                                | 37  | Lear.....                                    | 222     | Bronco .....                                                        | 302     |

**CV Boot Clamp Kit With Economy Banding Tool**

EPI ..... 311

**CV Boot Clamp Pliers**

Bronco ..... 302

**CV Boot Grease Pack**

Bronco ..... 302

**CV Tools**

Bronco ..... 302

**Cycle Care Gift Set**

S100 ..... 281

**Cylinder Hones**

Bronco ..... 303

**Cylinder Honing Brushes**

Bronco ..... 303

**D****D.I.D**

D.I.D Wheels ..... 101-104

Dirt star St-X 16X1.85 ..... 101

Dirt star St-X 19X1.40 ..... 102

Dirt star St-X 21X1.60 ..... 104

Original Dirt star ..... 101

Original Dirt star 18X2.15 ..... 101

Original Dirt star 18X2.50 ..... 102

Original Dirt star 19X1.85 ..... 102

Original Dirt star 19X2.15 ..... 103

Original Dirt star 19X2.50 ..... 103

Original Dirt star 21X1.85 ..... 103

**D.I.D Wheels**

D.I.D ..... 101-104

**Damper Rob Fork Tool**

Motion Pro ..... 352

**Damping Rod Holder**

Motion Pro ..... 342

**Dapco**

Dapco Industries Carburetor Leak Detector ..... 307

Primer Plunger ..... 478

**Dapco Industries Carburetor Leak Detector**

Dapco ..... 307

**Dc Power Connection Receptacle**

Deltran ..... 439

**Degree Wheel**

Motion Pro ..... 332

**Delta Steel Wheels**

ITP ..... 124

**Deltran**

12.5 Ft Extension Lead ..... 440

25 Ft Extension Lead ..... 440

4 Bank Battery Charger ..... 436-437

5 Bank Battery Charger ..... 437

6 Ft Quick Disconnect Extension Cable ..... 440

Battery Chargers ..... 434-437

Battery Maintainer ..... 434-436

Battery Tender Case ..... 441

Battery Tender Junior ..... 434

Battery Tender Plus ..... 434-435

Battery Tender Plus 3 Amp ..... 435

Battery Tender Plus 4 Amp ..... 435

Battery Tender Plus 5 Amp ..... 435

Battery Tender Power Tender ..... 436

Cigarette Lighter Adaptor ..... 441

Dc Power Connection Receptacle .. 439

Digital Voltage Indicator ..... 440

Female Cigarette Adaptor ..... 441

Jump Starter ..... 438

Multiple Outlet Battery Charger 436-437

Power Pack ..... 438

Quick Disconnect Plug W/ USB Charger ..... 440

Quick Disconnect Ring Terminals ... 439

Solar Controller ..... 438

Trickle Charger ..... 434-436

USB Wall Charger ..... 441

Waterproof Battery Tender ..... 434

**Deluxe 12V Tester**

Performance Tool ..... 397

**Deluxe Auxiliary Tank**

Motion Pro ..... 321

**Deluxe Compression Tester Kit**

Performance Tool ..... 391

**Deluxe Container Hose**

VP ..... 427

**Deluxe Piston Pin Puller**

Motion Pro ..... 347

**Deluxe Siphon Hose**

Performance Tool ..... 388

**Deluxe Spring Tool**

Snow Stuff ..... 319

**Deluxe Spring Tool Multi-Pack**

Snow Stuff ..... 319

**Deluxe Suspension Bearing Service Kit**

Motion Pro ..... 323

**Detail & Wax**

S100 ..... 281

**Detailing Kit**

Liquid Performance ..... 223

**Detailing Set & Swabs**

S100 ..... 281

**Diablo Power cruiser**

Pirelli ..... 59

**Diablo Rosso II**

Pirelli ..... 53

**Diablo Rosso III**

Pirelli ..... 53

**Diablo Rosso IV**

Pirelli ..... 52

**Diablo Rosso IV Corsa**

Pirelli ..... 52

**Diablo Rosso Scooter**

Pirelli ..... 54

**Diablo Supercorsa SP V3**

Pirelli ..... 51

**Diablo Supercorsa SP V4**

Pirelli ..... 51

**Diaphragm**

Keihin ..... 492

**Differential Lubricant**

Klotz ..... 216

**Digital 4-Stroke Leak Down Tester**

Motion Pro ..... 337

**Digital Multimeter**

Performance Tool ..... 396

**Digital Tire Inflator**

Performance Tool ..... 387

**Digital Tire Pressure Gauge**

Performance Tool ..... 381

**Digital Tire Pressure Gauge 60Psi**

Motion Pro ..... 366

**I N D E X**



|                                                  |           |
|--------------------------------------------------|-----------|
| <b>Ergo Spoke Wrench 5mm,6mm,6.5mm,6.8mm,7mm</b> |           |
| Motion Pro .....                                 | 364       |
| <b>Ergo Spoke Wrench, Spline Drive</b>           |           |
| Motion Pro .....                                 | 357       |
| <b>Ethanol Treatment</b>                         |           |
| Klotz.....                                       | 215       |
| Motorex.....                                     | 255       |
| <b>Evans</b>                                     |           |
| Prep Fluid .....                                 | 201       |
| Waterless Coolant.....                           | 201       |
| Waterless Prep Fluid.....                        | 201       |
| <b>Exedra G701</b>                               |           |
| Bridgestone.....                                 | 18        |
| <b>Exedra G702</b>                               |           |
| <b>Bridgestone.....</b>                          | <b>18</b> |
| <b>Exedra G704</b>                               |           |
| Bridgestone.....                                 | 18        |
| <b>Exedra G709</b>                               |           |
| Bridgestone.....                                 | 18        |
| <b>Exedra G850</b>                               |           |
| Bridgestone.....                                 | 19        |
| <b>Exedra G851</b>                               |           |
| Bridgestone.....                                 | 19        |
| <b>Exedra G852</b>                               |           |
| Bridgestone.....                                 | 18        |
| <b>Exedra G853</b>                               |           |
| Bridgestone.....                                 | 18        |
| <b>Exedra Max</b>                                |           |
| Bridgestone.....                                 | 19        |
| <b>Exhaust Spring Tool</b>                       |           |
| SPI.....                                         | 420       |
| <b>Exhaust Spring Tool Round Handle</b>          |           |
| SPI.....                                         | 420       |
| <b>Exhaust Wrap</b>                              |           |
| Helix.....                                       | 313       |
| <b>Explore 725 Utility Track</b>                 |           |
| Camso .....                                      | 169       |
| <b>Extender</b>                                  |           |
| Mikuni .....                                     | 525       |
| <b>Extra Large In-Line Fuel Filter</b>           |           |
| SPI.....                                         | 536-537   |
| <b>Eyelet Terminal Connector</b>                 |           |
| Noco .....                                       | 449       |
| <b>EZ 5 Combo Jug</b>                            |           |
| Risk.....                                        | 411       |

|                                           |     |
|-------------------------------------------|-----|
| <b>EZ Utility Jug</b>                     |     |
| Risk.....                                 | 411 |
| <b>F</b>                                  |     |
| <b>Fab-1</b>                              |     |
| Maxima .....                              | 242 |
| <b>Fabric Air Filter Oil</b>              |     |
| PJ1.....                                  | 278 |
| <b>Fabric Filter Care Kit</b>             |     |
| PJ1.....                                  | 279 |
| <b>Fabric Filter Oil</b>                  |     |
| Klotz.....                                | 209 |
| <b>Face Gasket Tm28</b>                   |     |
| Mikuni .....                              | 519 |
| <b>Fast Black Engine &amp; Case Paint</b> |     |
| PJ1.....                                  | 277 |
| <b>Fast Black Epoxy Paint</b>             |     |
| PJ1.....                                  | 276 |
| <b>Fast Black Exhaust Paint</b>           |     |
| PJ1.....                                  | 277 |
| <b>Fast Detail Spray</b>                  |     |
| Pig Splt .....                            | 275 |
| <b>Fast Orange Bar Soap</b>               |     |
| Permatex .....                            | 273 |
| <b>Fast Orange Hand Cleaner</b>           |     |
| Permatex .....                            | 273 |
| <b>FCR Carburetor Tool</b>                |     |
| Motion Pro .....                          | 341 |
| <b>Feeler Gauges</b>                      |     |
| Performance Tool.....                     | 403 |
| <b>Female Cigarette Adaptor</b>           |     |
| Deltran .....                             | 441 |
| <b>Fett Grease</b>                        |     |
| Motorex.....                              | 255 |
| <b>Fiberglass Cleaner</b>                 |     |
| Bio-Kleen .....                           | 197 |
| <b>Filter Charger Oil</b>                 |     |
| K&N .....                                 | 205 |
| <b>Filter Cleaner</b>                     |     |
| Klotz.....                                | 210 |
| PJ1.....                                  | 277 |
| <b>Filter Wrench</b>                      |     |
| Emgo .....                                | 308 |

|                                            |     |
|--------------------------------------------|-----|
| <b>Finish Restorer</b>                     |     |
| S100 .....                                 | 281 |
| <b>Firepoint 1000 Lumen Flashlight</b>     |     |
| Performance Tool.....                      | 389 |
| <b>First Aid Kit</b>                       |     |
| Performance Tool.....                      | 388 |
| <b>Fittings Bs-1201 Pk10</b>               |     |
| Motion Pro .....                           | 353 |
| <b>Fittings Sg-145 Pk10</b>                |     |
| Motion Pro .....                           | 353 |
| <b>Flat Slide Pilot Screw</b>              |     |
| Mikuni .....                               | 516 |
| <b>Flex &amp; Fold Funnel 3 Pc. Bundle</b> |     |
| Caliber .....                              | 304 |
| <b>Flex &amp; Fold Funnel Large</b>        |     |
| Caliber .....                              | 304 |
| <b>Flex &amp; Fold Funnel Medium</b>       |     |
| Caliber .....                              | 304 |
| <b>Flex &amp; Fold Funnel Small</b>        |     |
| Caliber .....                              | 304 |
| <b>Flex Grease (50 Grams)</b>              |     |
| Kluber .....                               | 318 |
| <b>Flexit 2.0 Flexible Flashlight</b>      |     |
| Risk.....                                  | 414 |
| <b>Flexit Headlamp Pro 650 Lumen</b>       |     |
| Risk.....                                  | 412 |
| <b>Flexit Pocket Light</b>                 |     |
| Risk.....                                  | 414 |
| <b>Flexit Solar Flexible Flashlight</b>    |     |
| Risk.....                                  | 415 |
| <b>Flexit Under Hood Light</b>             |     |
| Risk.....                                  | 414 |
| <b>Fli Pro Telescoping Light</b>           |     |
| Risk.....                                  | 412 |
| <b>Float</b>                               |     |
| Mikuni .....                               | 517 |
| <b>Float</b>                               |     |
| Mikuni .....                               | 524 |
| <b>Float Arms</b>                          |     |
| Mikuni .....                               | 520 |
| <b>Float Bowel Gasket</b>                  |     |
| Mikuni .....                               | 519 |
| <b>Float Bowl Drain Plug</b>               |     |
| Mikuni .....                               | 520 |

|                                          |                                            |                                          |
|------------------------------------------|--------------------------------------------|------------------------------------------|
| <b>Float Bowl Drain Screw</b>            | <b>Fogging Oil</b>                         | Motul.....266                            |
| Keihin.....495                           | Lubrimatic .....236                        | <b>Fork Seal Bullet</b>                  |
| <b>Float Bowl Gasket</b>                 | Sta-Bil .....285                           | Motion Pro .....322                      |
| Keihin.....495                           | <b>Folding Utility Knife</b>               | <b>Fork Seal Driver</b>                  |
| <b>Float Bowl Maine Jet Baffle Plate</b> | Performance Tool.....374                   | Moton Pro .....326                       |
| Mikuni .....527                          | <b>Foot Pump</b>                           | <b>Fork Spring Tool For HD</b>           |
| <b>Float Bowl Screw</b>                  | Helix.....313                              | Motion Pro .....360                      |
| Keihin.....497                           | <b>Fork Alignment Tool</b>                 | <b>Formula 4T Oil</b>                    |
| <b>Float Chamber Gasket</b>              | Motion Pro .....324                        | Motorex.....251                          |
| Mikuni .....524                          | <b>Fork Cap Socket</b>                     | <b>Freeride XC Track</b>                 |
| <b>Float Chamber Screw</b>               | Motin Pro .....325                         | Camso .....166                           |
| Mikuni .....502                          | <b>Fork Cap Socket</b>                     | <b>Fuel Filter</b>                       |
| <b>Float Pin</b>                         | Motion Pro .....362                        | Emgo .....480-481                        |
| Keihin.....496                           | <b>Fork Cap Socket 39mm HD</b>             | <b>Fuel Filter - 6mm</b>                 |
| <b>Float Valve Clip</b>                  | Motion Pro .....364                        | Motion Pro .....532                      |
| Keihin.....490                           | <b>Fork Cap Socket 41mm HD</b>             | <b>Fuel Injection Line</b>               |
| <b>Float Valve Needle</b>                | Motion Pro .....363                        | Helix Racing.....489                     |
| Keihin.....491-495                       | <b>Fork Cap Socket 49mm</b>                | <b>Fuel Injector Cleaner</b>             |
| <b>Floats</b>                            | Motion Pro .....364                        | Motion Pro .....247                      |
| Mikuni .....520                          | <b>Fork Cap Tool</b>                       | <b>Fuel Injector Cleaner Kit For Ev1</b> |
| <b>Fluid Pump</b>                        | Motion Pro .....359                        | Motion Pro .....351                      |
| Performance Tool.....388                 | <b>Fork Cap Tool</b>                       | <b>Fuel Injector Cleaner Kit For Evg</b> |
| <b>Fly Wheel Puller</b>                  | Motion Pro .....359                        | Motion Pro .....351                      |
| Motion Pro .....334                      | <b>Fork Cap Tool For Kyb, 49mm</b>         | <b>Fuel Injector Cleaner Kit For Hv2</b> |
| <b>Foam Cannon</b>                       | Motion Pro .....327                        | Motion Pro .....351                      |
| Maxima .....243                          | <b>Fork Cap Wrench 49mm</b>                | <b>Fuel Injector Cleaner Kit For Nd</b>  |
| <b>Foam Filter Cleaner</b>               | Motion Pro .....361                        | Motion Pro .....350                      |
| Liqui Moly.....234                       | <b>Fork Cap Wrench 49mm / 50mm</b>         | <b>Fuel Injector Cleaner Kit For Nyb</b> |
| PJ1.....277                              | Motion Pro .....363                        | Motion Pro .....350                      |
| UNI Filter.....297                       | <b>Fork Cap Wrench 50mm</b>                | <b>Fuel Injector Cleaner Pigtail</b>     |
| <b>Foam Filter Oil</b>                   | Motion Pro .....364                        | Motion Pro .....349                      |
| Klotz.....210                            | <b>Fork Cap Wrench 50mm / 14mm</b>         | <b>Fuel Jugs</b>                         |
| <b>Foam Filter Oil</b>                   | Motion Pro .....363                        | VP .....426-428                          |
| Liqui Moly.....235                       | <b>Fork Compression Valve Removal Tool</b> | <b>Fuel Line Clip 3/16" 1/4" 5/16"</b>   |
| PJ1.....278                              | Motion Pro .....360                        | SPI.....535                              |
| UNI Filter.....297                       | <b>Fork Fluid</b>                          | <b>Fuel Line</b>                         |
| <b>Foam Filter Service Kit</b>           | PJ1.....277                                | Helix Racing.....488-489                 |
| UNI Filter.....297                       | Sta-Bil .....285                           | <b>Fuel Line - Blue</b>                  |
| <b>Foam Filter Treatment</b>             | <b>Fork Hex Tool 22mm</b>                  | SPI.....534                              |
| Maxima .....241-242                      | Motion Pro .....363                        | <b>Fuel Line - Clear</b>                 |
| <b>Foaming Car Wash</b>                  | <b>Fork Oil</b>                            | SPI.....535                              |
| Klotz.....216                            | Klotz.....211                              | <b>Fuel Line Clamp With Fitting Kit</b>  |
| <b>Foaming Power wash</b>                | Liqui Moly.....229-230                     | Motion Pro .....325                      |
| Twin Air .....296                        | Maxima .....240-246                        | <b>Fuel Line Clip 1/4"</b>               |
|                                          | Motorex.....254                            | SPI.....535                              |

|                                     |                             |                                      |
|-------------------------------------|-----------------------------|--------------------------------------|
| <b>Fuel Line Clip 3/16"</b>         | GBC ..... 107-109           | 303 Protectant ..... 202             |
| SPI ..... 535                       | <b>Gear 300 Oil</b>         | Antifreeze & Water Remover ..... 202 |
| <b>Fuel Pump</b>                    | Motul ..... 265             | Sta-Bil ..... 202                    |
| Mikuni ..... 509                    | <b>Gear And Chain Oil</b>   | Sta-Bil Carburetor & Choke ..... 202 |
| <b>Fuel Pump Gasket</b>             | Klotz ..... 213-215         | Sta-Bil Fuel Stabilizer ..... 202    |
| Keihin ..... 492                    | <b>Gear Competition</b>     | Sta-Bil Marine ..... 202             |
| <b>Fuel Screw Washer</b>            | Motul ..... 264             | <b>Goldfire Motor Oil</b>            |
| Mikuni ..... 513                    | <b>Gear Jammer</b>          | PJ1 ..... 276                        |
| <b>Fuel Stabilizer</b>              | Motion Pro ..... 346        | <b>Grass/Ice Drag Racing Track</b>   |
| Liqui Moly ..... 231                | <b>Gear Lube</b>            | Camso ..... 170                      |
| Sta-Bil ..... 283-284               | Lubrimatic ..... 236        | <b>Grease</b>                        |
| <b>Fuel Star</b>                    | <b>Gear Oil</b>             | Lear ..... 222                       |
| Hose Clamp Kits ..... 487           | Klotz ..... 213-215         | Liqui Moly ..... 233                 |
| <b>Fuel Valve 5/16"</b>             | Liqui Moly ..... 228        | Performance Tool ..... 272           |
| Motion Pro ..... 530                | Maxima ..... 237-246        | <b>Grease Gun</b>                    |
| <b>Funnel W/ 18" Spout</b>          | Motorex ..... 252-253       | Performance Tool ..... 380-381       |
| Performance Tool ..... 387          | Motul ..... 264-265         | <b>Grease Gun Coupler</b>            |
| <b>Funnels</b>                      | <b>Gearbox Oil</b>          | Performance Tool ..... 386           |
| Caliber ..... 304                   | Motul ..... 265             | <b>Grease Injector Needle</b>        |
| <b>Fuse Holder With 20 Amp Fuse</b> | <b>Gen 5X1</b>              | Performance Tool ..... 404           |
| Emgo ..... 308                      | Noco ..... 447              | <b>Grease Spray</b>                  |
|                                     | <b>Gen 5X3</b>              | Motorex ..... 261                    |
|                                     | Noco ..... 447              | <b>Green Tubing</b>                  |
|                                     | <b>Genius 1</b>             | Helix Racing ..... 489               |
|                                     | Noco ..... 445              | <b>Grip Glue</b>                     |
|                                     | <b>Genius 10</b>            | Renthal ..... 282                    |
|                                     | Noco ..... 445              | <b>Grip Glue Adhesive</b>            |
|                                     | <b>Genius 2</b>             | Motion Pro ..... 247                 |
|                                     | Noco ..... 445              | <b>Griplock</b>                      |
|                                     | <b>Genius 2X2</b>           | Threebond ..... 293                  |
|                                     | Noco ..... 446              | <b>Gun Care Spray</b>                |
|                                     | <b>Genius 2X4</b>           | Motorex ..... 260                    |
|                                     | Noco ..... 446              | <b>GYZ Battery</b>                   |
|                                     | <b>Genius 5</b>             | Yuasa ..... 457                      |
|                                     | Noco ..... 445              |                                      |
|                                     | <b>Genpro 10X1</b>          |                                      |
|                                     | Noco ..... 447              |                                      |
|                                     | <b>Genpro 10X3</b>          |                                      |
|                                     | Noco ..... 447              |                                      |
|                                     | <b>Genpro 10X4</b>          |                                      |
|                                     | Noco ..... 448              |                                      |
|                                     | <b>Get Bent Hose Bender</b> |                                      |
|                                     | VP ..... 427                |                                      |
|                                     | <b>Gold Eagle</b>           |                                      |
|                                     | 104 Octane Boost ..... 202  |                                      |

## G

|                                   |  |
|-----------------------------------|--|
| <b>Gasket Maker</b>               |  |
| Permatex ..... 273                |  |
| Threebond ..... 291               |  |
| <b>Gasket Maker &amp; Sealant</b> |  |
| J-B Weld ..... 204                |  |
| <b>Gasket Scraper</b>             |  |
| Motion Pro ..... 356              |  |
| <b>Gasket Scraper Tool</b>        |  |
| Helix ..... 313                   |  |
| <b>Gauntlet</b>                   |  |
| Kenda ..... 77                    |  |
| <b>GBC</b>                        |  |
| Dirt Commander ..... 108          |  |
| Dirt Commander 2.0 ..... 109      |  |
| Dirt Devil ..... 109              |  |
| GBC Tires ..... 107-109           |  |
| Kanati Mini Mongrel ..... 108     |  |
| Kanati Terra Master ..... 107     |  |
| Mongrel ..... 107                 |  |
| <b>GBC Tires</b>                  |  |

# INDEX

## H

|                                                  |  |                                             |                                         |
|--------------------------------------------------|--|---------------------------------------------|-----------------------------------------|
| <b>Hacksaw Trail Track</b>                       |  | Screwdriver Valve Stem Tool ..... 312       | <b>Holeshot XC</b>                      |
| Camso ..... 163                                  |  | Spring Pull Tool ..... 312                  | ITP ..... 111                           |
| <b>Hardwar Kit, Metric Euro 54 Piece Set</b>     |  | Tire Iron With Rim Protector 380mm .... 313 | <b>Holeshot XCR</b>                     |
| Motion Pro ..... 358                             |  |                                             | ITP ..... 112                           |
| <b>Hardware Kits</b>                             |  | <b>Helix Racing</b>                         | <b>Holeshot XCT</b>                     |
| Caliber ..... 305                                |  | Black Tubing ..... 489                      | ITP ..... 113                           |
| <b>HD 80W90 Gear Oil</b>                         |  | Blue Tubing ..... 489                       | <b>Hoop B01</b>                         |
| Motul ..... 265                                  |  | Clear Tubing ..... 489                      | Bridgestone ..... 25                    |
| <b>Heat Shield With Adhesive</b>                 |  | Fuel Injection Line ..... 489               | <b>Hoop B02</b>                         |
| Helix ..... 314                                  |  | Fuel Line ..... 488-489                     | Bridgestone ..... 26                    |
| <b>Heat Shrink Tubing</b>                        |  | Green Tubing ..... 489                      | <b>Hoop B03</b>                         |
| All Balls ..... 474                              |  | Hose Clamp ..... 488                        | Bridgestone ..... 26                    |
| <b>Heavy Duty Cricut Tester</b>                  |  | Hose Protectors ..... 488                   | <b>Hose Bender 1" O.D. Hose</b>         |
| Performance Tool ..... 398                       |  | Red Tubing ..... 489                        | SPI ..... 419                           |
| <b>Heavy Duty Muffler Packing</b>                |  | Transparent Tubing ..... 488                | <b>Hose Benders</b>                     |
| Helix ..... 312                                  |  | Yellow Tubing ..... 489                     | Bronco ..... 303                        |
| <b>Heavy Duty Nut Splitter</b>                   |  | <b>Helmet Care Spray</b>                    | <b>Hose Benders</b>                     |
| Performance Tool ..... 402                       |  | Motorex ..... 261                           | SPI ..... 419                           |
| <b>Heavy Duty Pin Spanner</b>                    |  | <b>Hex Axle Tool 17,19,22,24mm</b>          | <b>Hose Clamp</b>                       |
| Motion Pro ..... 335                             |  | Motion Pro ..... 334                        | Helix Racing ..... 488                  |
| <b>Heavy Duty Spring Hook</b>                    |  | <b>Hex Bit Socket 5/32</b>                  | <b>Hose Clamp Kits</b>                  |
| Motion Pro ..... 332                             |  | Performance Tool ..... 406                  | Fuel Star ..... 487                     |
| <b>Heavy Duty Track Clip Tool</b>                |  | <b>Hex Insert Stud</b>                      | <b>Hose Clamps</b>                      |
| SPI ..... 419                                    |  | Woody's ..... 429                           | Motion Pro ..... 342                    |
| <b>Heavy-Duty Clutch Holder Tool</b>             |  | <b>Hex Jet Assortment</b>                   | <b>Hose Protectors</b>                  |
| Motion Pro ..... 338                             |  | EBC ..... 486                               | Helix Racing ..... 488                  |
| <b>Heavy Duty Wet Power Wipes</b>                |  | <b>Hex Jets</b>                             | <b>Hose Removal Tool</b>                |
| Twin Air ..... 296                               |  | EBC ..... 485                               | Motion Pro ..... 356                    |
| <b>Heet Fuel Line Antifreeze</b>                 |  | <b>Hex Main Jets</b>                        | <b>Hose Shears</b>                      |
| Sta-Bil ..... 284                                |  | Mikuni ..... 505, 511                       | Motion Pro ..... 531                    |
| <b>Helix</b>                                     |  | <b>High Gloss Clear Acrylic</b>             | <b>Hotcams</b>                          |
| Exhaust Wrap ..... 313                           |  | PJ1 ..... 279                               | Standard Cam Shaft Installation Kit 316 |
| Foot Pump ..... 313                              |  | <b>High Visibility Led Bit Driver</b>       | Value Shims ..... 316                   |
| Gasket Scraper Tool ..... 313                    |  | Performance Tool ..... 390                  | Valve Shim 5Pk ..... 315                |
| Heat Shield With Adhesive ..... 314              |  | <b>Holding Washer</b>                       | Valve Shims ..... 316                   |
| Heavy Duty Muffler Packing ..... 312             |  | Mikuni ..... 505                            | <b>Housing End 7mm</b>                  |
| Jet Cleaning Tool ..... 313                      |  | <b>Holeshot</b>                             | Motion Pro ..... 358                    |
| Low Density Muffler Packing 1"X11"X16" ..... 312 |  | ITP ..... 111                               | <b>Hurricane</b>                        |
| Magnetic Bolt Tray ..... 312                     |  | <b>Holeshot Atr</b>                         | ITP ..... 125                           |
| Radiator Fin Straightener ..... 312              |  | ITP ..... 112                               | <b>Hurricane 175 XC Track</b>           |
| Safety Wire .032 Dia Stainless ..... 313         |  | <b>Holeshot Gncc</b>                        | Camso ..... 175                         |
|                                                  |  | ITP ..... 112                               | <b>Hydraulic Brake Bleeder</b>          |
|                                                  |  | <b>Holeshot HD</b>                          | Motion Pro ..... 333                    |
|                                                  |  | ITP ..... 113                               | <b>Hydraulic Fluid</b>                  |
|                                                  |  | <b>Holeshot Mxr6</b>                        | Motorex ..... 255                       |
|                                                  |  | ITP ..... 111                               |                                         |

|                                         |          |
|-----------------------------------------|----------|
| <b>Hypoid Gear Oil</b>                  |          |
| Motorex.....                            | 252      |
| <b>Ibex</b>                             |          |
| Kenda.....                              | 76       |
| <b>Ice Arrowhead 130 Track</b>          |          |
| Camso.....                              | 177      |
| <b>Ice Attack Trail Track</b>           |          |
| Camso.....                              | 164      |
| <b>Ice Attack XT Trail Track</b>        |          |
| Camso.....                              | 164      |
| <b>Ice Cobra 1.6 XC Track</b>           |          |
| Camso.....                              | 172      |
| <b>Ice Oval/Lemans Racing Track</b>     |          |
| Camso.....                              | 170      |
| <b>Ice Storm 150 Trail Track</b>        |          |
| Camso.....                              | 174      |
| <b>Ice Water</b>                        |          |
| Engine Ice.....                         | 200      |
| <b>Ice Widetrack Utility Track</b>      |          |
| Camso.....                              | 169      |
| <b>Iceflow High Performance Coolant</b> |          |
| Twin Air.....                           | 296      |
| <b>Idle Adjuster</b>                    |          |
| Keihin.....                             | 491, 493 |
| <b>Idle Adjuster Screw</b>              |          |
| Mikuni.....                             | 505-506  |
| <b>Idle Adjusting Screw</b>             |          |
| Mikuni.....                             | 516      |
| <b>Idle Rod</b>                         |          |
| Mikuni.....                             | 526      |
| <b>Idle Screw Only Mik Carburetor</b>   |          |
| Motion Pro.....                         | 341      |
| <b>Impact Driver With Short Bit</b>     |          |
| Emgo.....                               | 309      |
| <b>Inertia</b>                          |          |
| ITP.....                                | 124      |
| <b>Injection Oil</b>                    |          |
| Maxima.....                             | 239      |
| <b>In-Line Fuel Filter</b>              |          |
| SPI.....                                | 536      |
| <b>In-Line Fuel Filter 1/4"</b>         |          |
| SPI.....                                | 534, 537 |

|                                               |         |
|-----------------------------------------------|---------|
| <b>In-Line Fuel Filter 5/16"</b>              |         |
| SPI.....                                      | 534     |
| <b>Inline Fuel Valve</b>                      |         |
| Motion Pro.....                               | 530     |
| <b>Inline Fuel Valve Brass</b>                |         |
| Motion Pro.....                               | 530     |
| <b>Intact Mx 50 Spray</b>                     |         |
| Motorex.....                                  | 261     |
| <b>In-Tank Fuel Filter For 1/4" Fuel Line</b> |         |
| SPI.....                                      | 536     |
| <b>In-Tank Fuel Filter For 3/8" Fuel Line</b> |         |
| SPI.....                                      | 535     |
| <b>Intense XC Track</b>                       |         |
| Camso.....                                    | 166     |
| <b>Intermediate M6001</b>                     |         |
| Maxxis.....                                   | 88      |
| <b>Intersect</b>                              |         |
| ITP.....                                      | 120     |
| <b>Iso-Heat Water Remover</b>                 |         |
| Sta-Bil.....                                  | 284     |
| <b>ITP</b>                                    |         |
| Blackwater Evolution.....                     | 118     |
| Chrome Cap.....                               | 124     |
| Coyote.....                                   | 118     |
| Crytid.....                                   | 119     |
| Delta Steel Wheels.....                       | 124     |
| Holeshot.....                                 | 111     |
| Holeshot ATR.....                             | 112     |
| Holeshot GNCC.....                            | 112     |
| Holeshot HD.....                              | 113     |
| Holeshot MXR6.....                            | 111     |
| Holeshot XC.....                              | 111     |
| Holeshot XCR.....                             | 112     |
| Holeshot XCT.....                             | 113     |
| Hurricane.....                                | 125     |
| Inertia.....                                  | 124     |
| Intersect.....                                | 120     |
| ITP Lug Nut.....                              | 125     |
| ITP Re[Placement Key                          |         |
| For Alug20Bx.....                             | 125     |
| ITP Tires.....                                | 111-121 |
| ITP Wheels.....                               | 122     |
| Mammoth Mayhem.....                           | 116     |
| Mega Mayhem.....                              | 116     |
| Momentum.....                                 | 125     |

|                                   |     |
|-----------------------------------|-----|
| MT 911.....                       | 120 |
| Mud Lite 2.....                   | 114 |
| Mud Lite AT.....                  | 115 |
| Mud Lite SP.....                  | 114 |
| Mud Lite XL.....                  | 114 |
| Mud Lite XTR.....                 | 115 |
| Mud Lite XXL.....                 | 115 |
| Sand Star.....                    | 119 |
| Savage XT.....                    | 117 |
| Sd Beadlock Cap.....              | 125 |
| SS Alloy Chrome Cap.....          | 123 |
| SS Alloy SS 216 & 316 Black Cap.. | 123 |
| SS Alloy SS212.....               | 122 |
| SS Alloy SS312.....               | 122 |
| SS Alloy SS316.....               | 123 |
| SS Alloy Tall                     |     |
| Viking/Wolverine Cap.....         | 123 |
| Tenacity.....                     | 120 |
| Terra Cross R/T.....              | 119 |
| Terra-Hook.....                   | 116 |
| Tornado.....                      | 124 |
| Ultra Cross R Spec Race.....      | 117 |
| Versa Cross.....                  | 121 |
| Versa Cross V3.....               | 121 |

|                                          |         |
|------------------------------------------|---------|
| <b>ITP Lug Nut</b>                       |         |
| ITP.....                                 | 125     |
| <b>ITP Re[Placement Key For Alug20Bx</b> |         |
| ITP.....                                 | 125     |
| <b>ITP Tires</b>                         |         |
| ITP.....                                 | 111-121 |
| <b>ITP Wheels</b>                        |         |
| ITP.....                                 | 122     |

## J

|                            |     |
|----------------------------|-----|
| <b>JB-Weld 204</b>         |     |
| Kwik Stick.....            | 204 |
| Kwik Wood Epoxy.....       | 204 |
| Marineweld Tube.....       | 204 |
| Minuteweld.....            | 204 |
| Waterweld Epoxy Putty..... | 204 |
| Woodweld Syringe.....      | 204 |
| <b>JB-Weld</b>             |     |
| J-B Weld.....              | 204 |

# INDEX

**Jet Block Screw**  
 Mikuni ..... 525

**Jet Cleaning Tool**  
 Helix ..... 313

**Jet Kits**  
 EBC ..... 486

**Jet Needle**  
 Keihin ..... 491-493

**Jet Needle Clip**  
 Keihin ..... 494

**Jet Needles**  
 Mikuni ..... 509

**Jet Pump Oil**  
 Klotz ..... 211, 221

**Jets**  
 EBC ..... 482-486

**Joker 440 Synthetic Spray**  
 Motorex ..... 258

**Jug Handle**  
 Motorsport Products ..... 369

**Jumbo Chain Tool**  
 Motion Pro ..... 343

**Jump Starter**  
 Deltran ..... 438

**Jumper Cables**  
 Emgo ..... 472  
 Yuasa ..... 446

## K

**K&N**  
 Filter Charger Oil ..... 205

**K100**  
 K100 ..... 206

**K284 Front Max**  
 Kenda ..... 130

**K290 Scorpion**  
 Kenda ..... 130

**K299 Bearclaw**  
 Kenda ..... 131

**K299A Bearclaw XI**  
 Kenda ..... 132

**K300 Dominator**  
 Kenda ..... 129

**K3204R Klever X/T**  
 Kenda ..... 133

**K3211/K3210F Havok**  
 Kenda ..... 131

**K3213 Cros Trail**  
 Kenda ..... 134

**K530 Pathfinder**  
 Kenda ..... 130

**K532/K533 Klaw XC**  
 Kenda ..... 129

**K533**  
 Kenda ..... 129

**K538 Executioner**  
 Kenda ..... 133

**K576A Kongur**  
 Kenda ..... 133

**K587 Bearclaw Htr**  
 Kenda ..... 132

**K592 Bearclaw Evo**  
 Kenda ..... 132

**Kanati Mini Mongrel**  
 GBC ..... 108

**Kanati Terra Master**  
 GBC ..... 107

**Kanine KR20**  
 Kenda ..... 43

**Keihin**  
 Anchor Plate ..... 493  
 Baffle Plate ..... 497  
 Brass Idle Adjuster ..... 490  
 Cable Adjuster Nut ..... 490  
 Cable Holder ..... 491  
 Cap Cable Adjuster ..... 494  
 Carburetor Cable Adjuster ..... 491  
 Carburetor Jets ..... 497  
 Carburetor Top Cap ..... 490  
 Collar ..... 492  
 Cover Screw ..... 490  
 Diaphragm ..... 492  
 Drain Screw O-Ring ..... 495  
 Float Bowl Drain Screw ..... 495  
 Float Bowl Gasket ..... 495  
 Float Bowl Screw ..... 497  
 Float Pin ..... 496  
 Float Valve Clip ..... 490

Float Valve Needle ..... 491-495

Fuel Pump Gasket ..... 492

Idle Adjuster ..... 491, 493

Jet Needle ..... 491-493

Jet Needle Clip ..... 494

Keihin Air Adjusting Screw ..... 500

Keihin Air Adjusting Screw Spring... 500

Keihin Carburetors ..... 499-500

Keihin Collar ..... 501

Keihin Float ..... 500

Keihin Float Bowl ..... 500

Keihin Top Gasket ..... 500

Main Jets ..... 497

Needle Jet Cy Series ..... 501

Needle Valve ..... 491

Overflow Hose ..... 496

Round Main Jet ..... 497

Slow Jet ..... 497

Throttle Lever ..... 490

Throttle Spring ..... 493-494

Top Cover Gasket ..... 494

Vent Hose ..... 496

Vent Hose Slip ..... 496

Vent Tubing ..... 496

**Keihin Air Adjusting Screw**  
 Keihin ..... 500

**Keihin Air Adjusting Screw Spring**  
 Keihin ..... 500

**Keihin Carburetors**  
 Keihin ..... 499-500

**Keihin Collar**  
 Keihin ..... 501

**Keihin Float**  
 Keihin ..... 500

**Keihin Float Bowl**  
 Keihin ..... 500

**Keihin Top Gasket**  
 Keihin ..... 500

**Kenda**  
 Big Block K784 ..... 47  
 Cataclysm K6702 ..... 41  
 Challenger K657 ..... 43  
 Cruiser K671 ..... 46  
 Dual Sport ..... 81  
 Dual Sport K261 ..... 46

|                           |         |
|---------------------------|---------|
| Dual Sport K761 .....     | 47      |
| Gauntlet .....            | 77      |
| Ibex .....                | 76      |
| K284 Front Max .....      | 130     |
| K299 Bearclaw.....        | 131     |
| K299A Bearclaw XI .....   | 132     |
| K3211/K3210F Havok.....   | 131     |
| K530 Pathfinder .....     | 130     |
| K533 .....                | 129     |
| K592 Bearclaw Evo .....   | 132     |
| Kanine KR20.....          | 43      |
| Kenda Tires .....         | 75-83   |
| Klassic .....             | 82      |
| KM1 KM001 .....           | 41      |
| Kruz K673 .....           | 42      |
| Mastodon HT .....         | 134     |
| Retroactive K676 .....    | 42      |
| Rim Strips .....          | 189     |
| Sand Mad .....            | 77      |
| Scooter 433 .....         | 44      |
| Scooter 434 .....         | 44      |
| Scooter K329.....         | 45      |
| Scooter K413 .....        | 45      |
| Scooter K453 .....        | 44      |
| Scooter K761 .....        | 44      |
| Southwick 2 .....         | 76      |
| Street tires .....        | 41-48   |
| Super Tuff Tubes .....    | 188     |
| Tires .....               | 41-48   |
| Trakmaster 2.....         | 80      |
| Trakmaster DTR K6342..... | 48      |
| Tripple.....              | 80      |
| Tubes .....               | 186-190 |
| Tuff Tubes .....          | 187     |
| Washougal .....           | 79      |
| Washougal 2.....          | 79      |
| <b>Kenda</b>              |         |
| Equilibrium .....         | 75      |
| K290 Scorpion .....       | 130     |
| K300 Dominator.....       | 129     |
| K3204R Klever X/T.....    | 133     |
| K3213 Cros Trail .....    | 134     |
| K532/K533 Klaw XC .....   | 129     |
| K538 Executioner .....    | 133     |
| K576A Kongur.....         | 133     |

|                                       |         |
|---------------------------------------|---------|
| K587 Bearclaw Htr.....                | 132     |
| Kenda Tires .....                     | 129-135 |
| Kenda Trailer Tire Only .....         | 159     |
| Kenda Trailer Tire W/Wheel Combo..... | 158     |
| Kenda Trailer Tire W/Wheel Combo..... | 160     |
| Knarly.....                           | 81      |
| Mastodon AT .....                     | 135     |
| Millville 2 .....                     | 78      |
| Parker DT .....                       | 75      |

**Kenda Tires**

|             |                |
|-------------|----------------|
| Kenda ..... | 75-83, 129-135 |
|-------------|----------------|

**Kenda Trailer Tire Only**

|             |     |
|-------------|-----|
| Kenda ..... | 159 |
|-------------|-----|

**Kenda Trailer Tire W/Wheel Combo**

|             |     |
|-------------|-----|
| Kenda ..... | 158 |
| Kenda ..... | 160 |

**Klassic**

|             |    |
|-------------|----|
| Kenda ..... | 82 |
|-------------|----|

**Klotz**

|                                    |          |
|------------------------------------|----------|
| 2 Cycle Super Techniplate Oil..... | 207      |
| 4-Stroke Motorcycle Oil .....      | 208      |
| 50:1 Techniplate Oil .....         | 211      |
| Assembly Lube .....                | 210      |
| ATV/UTV Engine Oil .....           | 217      |
| ATV/UTV Engine Oil .....           | 212-213  |
| Benol 2 Cycle Oil .....            | 208      |
| Candle .....                       | 215, 211 |
| Chain Case Oil.....                | 215      |
| Chain Lube .....                   | 213      |
| Contact Cleaner.....               | 209      |
| Differential Lubricant.....        | 216      |
| Ethanol Treatment .....            | 215      |
| Fabric Filter Oil .....            | 209      |
| Filter Cleaner .....               | 210      |
| Foam Filter Oil .....              | 210      |
| Foaming Car Wash.....              | 216      |
| Fork Oil .....                     | 211      |
| Gear And Chain Oil.....            | 213-215  |
| Gear Oil .....                     | 213-215  |
| Jet Pump Oil .....                 | 211, 221 |
| Klotz Oil .....                    | 207-221  |
| Motorcycle Techniplate .....       | 207      |
| Motorcycle Techniplate Oil.....    | 220      |
| Mx4 Techniplate Oil .....          | 208      |
| Nitro Racing Additive .....        | 209      |

|                                |         |
|--------------------------------|---------|
| Octane Booster.....            | 209     |
| Oil Change Kits.....           | 217-220 |
| Outboard Techniplate Oil ..... | 210     |
| Primary Case Oil.....          | 214     |
| Quick Detailer .....           | 216     |
| R50 Techniplate Oil.....       | 212     |
| Skicraft Techniplate Oil ..... | 211     |
| Snowmobile Techniplate .....   | 207     |
| Snowx4 Engine Lubricant .....  | 216     |
| Storbilizer.....               | 215     |
| Synthetic Snowmobile Oil ..... | 207     |
| Synthetic V-Twin Oil.....      | 221     |
| Transmission Oil .....         | 213     |
| Uplon Fuel Lube .....          | 208     |
| V-Twin Techniplate Oil .....   | 212     |

**Klotz Oil**

|            |         |
|------------|---------|
| Klotz..... | 207-221 |
|------------|---------|

**Kluber**

|                             |     |
|-----------------------------|-----|
| Flex Grease (50 Grams)..... | 318 |
|-----------------------------|-----|

**KM1 Km001**

|             |    |
|-------------|----|
| Kenda ..... | 41 |
|-------------|----|

**Knarly**

|             |    |
|-------------|----|
| Kenda ..... | 81 |
|-------------|----|

**KPMI**

|                                  |     |
|----------------------------------|-----|
| Valve Guide Ball Hone Tool ..... | 317 |
| Valve Guide Reamer .....         | 317 |

**Kruz K673**

|             |    |
|-------------|----|
| Kenda ..... | 42 |
|-------------|----|

**Kwik Stick**

|                |     |
|----------------|-----|
| J-B Weld ..... | 204 |
|----------------|-----|

**Kwik Wood Epoxy**

|                |     |
|----------------|-----|
| J-B Weld ..... | 204 |
|----------------|-----|

**L**

**Large Oil Filter Pliers**

|                       |     |
|-----------------------|-----|
| Performance Tool..... | 403 |
|-----------------------|-----|

**Leak Down Tester**

|          |     |
|----------|-----|
| SPI..... | 419 |
|----------|-----|

**Lear**

|                             |     |
|-----------------------------|-----|
| ACF-50 .....                | 222 |
| Corrosion Block .....       | 222 |
| Corrosion Block Grease..... | 222 |
| Grease .....                | 222 |

**I N D E X**



|                             |                            |         |                                  |                |
|-----------------------------|----------------------------|---------|----------------------------------|----------------|
| <b>Mastodon AT</b>          | Suspension Clean.....      | 241     | Workzone.....                    | 138            |
| Kenda .....                 | Transmission Oil .....     | 238-246 | Zilla .....                      | 143            |
| <b>Mastodon HT</b>          | Tundra Snowmobile Oil..... | 239     | <b>Maxxis Tires</b>              |                |
| Kenda .....                 | V-Twin Engine Oil .....    | 237-245 | Maxxis.....                      | 85-89, 137-143 |
| <b>Maxima</b>               | Waterproof Grease .....    | 241     | <b>Maxxizilla</b>                |                |
| 5 Gallon Pail Pump .....    | <b>Maxxcross Desert IT</b> |         | Maxxis.....                      | 142            |
| Air Filter Care Kit .....   | Maxxis.....                | 86      | <b>Mega Mayhem</b>               |                |
| Air Filter Cleaner .....    | <b>Maxxcross IT</b>        |         | ITP .....                        | 116            |
| Antifreeze.....             | Maxxis.....                | 85      | <b>Metal Polish</b>              |                |
| Assembly Grease .....       | <b>Maxxcross MX-IH</b>     |         | Bio-Kleen .....                  | 197            |
| Assembly Lube .....         | Maxxis.....                | 89      | Liquid Performance.....          | 223            |
| Bio foam.....               | <b>Maxxcross MX-ST</b>     |         | <b>Metric Hard Ware Kit</b>      |                |
| Bio Wash.....               | Maxxis.....                | 87      | Motion Pro .....                 | 360            |
| Brake Fluid.....            | <b>Maxxcross SI</b>        |         | <b>Micro Bleeder</b>             |                |
| Break In Oil .....          | Maxxis.....                | 87      | Moton Pro .....                  | 329            |
| Chain Guard .....           | <b>Maxxcross SM</b>        |         | <b>Micro Bleeder</b>             |                |
| Chain Wax Care Kit .....    | Maxxis.....                | 86      | Motion Pro .....                 | 362            |
| Chaincase Oil .....         | <b>Maxxis</b>              |         | <b>Micro Fiber Cloth</b>         |                |
| Cleanup .....               | Bighorn 2.0 .....          | 138     | Bikebrite.....                   | 196            |
| Contact Cleaner.....        | Bighorn 3.0 .....          | 139     | <b>Microfiber Wash Mitt</b>      |                |
| Cool-Aide Concentrate ..... | Bighorn Radial .....       | 138     | Starbrite .....                  | 287            |
| Cool-Aide Coolant.....      | Carnage .....              | 140     | <b>Mid-Hard Stadium</b>          |                |
| Coolanol.....               | Carnivore .....            | 139     | Pirelli .....                    | 98             |
| Engine Oil .....            | Carnivore RT.....          | 139     | <b>Mid-Soft Stadium</b>          |                |
| Fab-1 .....                 | Ceros .....                | 142     | Pirelli .....                    | 98             |
| Foam Cannon .....           | Coronado .....             | 142     | <b>Mikuni</b>                    |                |
| Foam Filter Treatment ..... | DTR-1 .....                | 88      | Adjusting Locknut .....          | 507            |
| Fork Oil .....              | Intermediate M6001.....    | 88      | Air Adjusting Screw.....         | 515            |
| Gear Oil .....              | Liberty.....               | 141     | Air Screw .....                  | 517            |
| Injection Oil.....          | Maxxcross Desert IT.....   | 86      | Cable Adjust 32-28mm .....       | 525            |
| MPPI Penetrant Lube.....    | Maxxcross IT .....         | 85      | Cable Connector.....             | 526            |
| Octane Booster.....         | Maxxcross MX-IH .....      | 89      | Carburetor Mc.....               | 519            |
| Oil Change Kits.....        | Maxxcross MX-ST .....      | 87      | Carburetor Plate .....           | 520            |
| PWC Oil .....               | Maxxcross SI .....         | 87      | Carburetor Top (Vm34/28/29)..... | 523            |
| Quick 2 Mix .....           | Maxxcross SM .....         | 86      | Carburetors.....                 | 504            |
| Quick 2 Mix Bottle .....    | Maxxis Tires .....         | 137-143 | Clip Main Jet.....               | 525            |
| Quick Change Kits.....      | Maxxis Tires .....         | 85-89   | Conversion Kit .....             | 527            |
| SC1.....                    | Maxxizilla .....           | 142     | Drain Plug .....                 | 524            |
| SC1 Air Freshener .....     | MU511/MU521 .....          | 140     | Drain Plug Washer.....           | 520            |
| Scooter Gear Oil .....      | Rampage .....              | 141     | E Ring .....                     | 516            |
| Service Drum Oil.....       | Razr .....                 | 137     | Extender .....                   | 525            |
| Shock Fluid.....            | Razr 2 .....               | 137     | Face Gasket Tm28 .....           | 519            |
| Snow 4T.....                | Razr Plus MX.....          | 137     | Flat Slide Pilot Screw.....      | 516            |
| Snowmobile Oil.....         | Razr XT.....               | 140     | Float.....                       | 517            |
| Speed Wax .....             | Roxxzilla .....            | 141     | Float .....                      | 524            |

|                                      |                    |                                      |          |                                                    |     |
|--------------------------------------|--------------------|--------------------------------------|----------|----------------------------------------------------|-----|
| Float Arms.....                      | 520                | Pulse Pump Rebuild Kits .....        | 513      | <b>Mini Chain Press Tool</b>                       |     |
| Float Bowl Gasket.....               | 519                | Pump Cover.....                      | 507      | Motion Pro .....                                   | 345 |
| Float Bowl Drain Plug .....          | 520                | PWC Parts Kit.....                   | 512      | <b>Mini Dial Tire Pressure Gauge</b>               |     |
| Float Bowl Maine Jet Baffle Plate .. | 527                | Round Main Jets.....                 | 511-512  | Performance Tool.....                              | 381 |
| Float Chamber Gasket.....            | 524                | Rubber Cap .....                     | 515      | <b>Mini Multi Tool</b>                             |     |
| Float Chamber Screw .....            | 502                | Rubber Flange .....                  | 523, 525 | Performance Tool.....                              | 379 |
| Floats .....                         | 520                | Small Round Jet .....                | 504      | <b>Mini Razor Scraper</b>                          |     |
| Fuel Pump .....                      | 509                | Small Round Main Jet.....            | 503      | Performance Tool.....                              | 380 |
| Fuel Screw Washer.....               | 513                | Smooth Needle Jet .....              | 521      | <b>Mini Spring Hook</b>                            |     |
| Hex Main Jets .....                  | 505, 511           | Spring .....                         | 515, 517 | Moton Pro .....                                    | 328 |
| Holding Washer .....                 | 505                | Spring Plate .....                   | 523      | <b>Mini Tire Inflator</b>                          |     |
| Idle Adjuster Screw .....            | 505-506, 516       | Spring Seat Plate.....               | 523, 524 | Performance Tool.....                              | 373 |
| Idle Rod .....                       | 526                | Starter Lever .....                  | 504      | <b>Mini-Pro Dual Drive T-Handle</b>                |     |
| Jet Block Screw .....                | 525                | Starter Lever .....                  | 519      | Motion Pro .....                                   | 352 |
| Jet Needles.....                     | 509                | Starter Plunger.....                 | 515      | <b>Mini-Pro T-Handle Set 8, 10, 12, 13, 14mm</b>   |     |
| Maine Jet O-Ring.....                | 521                | Starter Plunger .....                | 521      | Motion Pro .....                                   | 348 |
| Maine Jet Ring.....                  | 520                | Super BN Valve .....                 | 507      | <b>Minuteweld</b>                                  |     |
| Mikuni Cap.....                      | 516                | Throttle Bell Lever Crank Pin.....   | 513      | J-B Weld .....                                     | 204 |
| Mikuni Fuel Pumps .....              | 502-503            | Throttle Stop Screw .....            | 516      | <b>Mixing Chamber</b>                              |     |
| Mikuni Nut.....                      | 513                | Throttle Valve.....                  | 523      | Mikuni .....                                       | 519 |
| Mikuni Screws.....                   | 510                | Throttle Valve Spring .....          | 503      | <b>MI16</b>                                        |     |
| Mixing Chamber.....                  | 519                | Throttle Valve Spring .....          | 506      | Bridgestone.....                                   | 29  |
| Mounting Flange .....                | 504                | Throttle Valve Spring .....          | 526      | <b>MI17</b>                                        |     |
| Needle Jet.....                      | 526                | TM Series Carburetors .....          | 514      | Bridgestone.....                                   | 29  |
| Needle Jet - Bleeder Type .....      | 522                | TM Series Flat Slide Carburetor .... | 521      | <b>Mobile Task Light</b>                           |     |
| Needle Jet - Primary Type .....      | 522                | Top Chamber Gasket.....              | 525      | Risk.....                                          | 415 |
| Needle Jet E Cli P.....              | 510                | Top Cover Gasket.....                | 519      | <b>Momentum</b>                                    |     |
| Needle Jet Setter .....              | 521                | Top Gasket 36mm-44mm .....           | 504      | ITP .....                                          | 125 |
| Needle Jet Setter O Ring.....        | 510                | Top Mixing Chamber.....              | 506      | <b>Mongrel</b>                                     |     |
| Needle Jets.....                     | 507                | Top Mixing Chamber.....              | 524      | GBC .....                                          | 107 |
| Needle Valve .....                   | 517                | Top Mixing Chamber Gasket .....      | 504      | <b>Mos2 Oil Shooter</b>                            |     |
| Assembly .....                       | 503-504, 506, 518  | Vent Tube Anchor Plate .....         | 521      | Liqui Moly.....                                    | 232 |
| Needle Valve Oring.....              | 509                | Washer.....                          | 518      | <b>Motion Pro</b>                                  |     |
| Needle Valve Washer .....            | 518                | <b>Mikuni Cap</b>                    |          | Fork Cap Socket.....                               | 325 |
| Nylon Ring .....                     | 526                | Mikuni .....                         | 516      | <b>Motion Pro</b>                                  |     |
| O-Ring .....                         | 513, 515, 517, 518 | <b>Mikuni Fuel Pumps</b>             |          | 2-Stroke Timing Kit For Water Cooled Engines ..... | 350 |
| Pilot Jets .....                     | 508                | Mikuni .....                         | 502-503  | 44mm Cr Bearing Retainer Tool ....                 | 339 |
| Pin Float.....                       | 522                | <b>Mikuni Nut</b>                    |          | 47mm Cr Seal / Bearing                             |     |
| Plastic Cap.....                     | 526                | Mikuni .....                         | 513      | Retainer Tool.....                                 | 339 |
| Plate .....                          | 517                | <b>Mikuni Screws</b>                 |          | 5 in 1 Damper Rod Bleeder Tool ....                | 331 |
| Plunger Rubber Cap .....             | 516                | Mikuni .....                         | 510      | Adapter Kit                                        |     |
| Pocket Tuner.....                    | 512                | <b>Millville 2</b>                   |          | For Air-Cooled Engine .....                        | 352 |
| Pop Off Pressure Gauge .....         | 503                | Kenda .....                          | 78       | Adjustable Torque                                  |     |
| Pop Off Pump Gauge .....             | 512                | <b>Mini Bleeder</b>                  |          | Wrench Adapter .....                               | 348 |

|                                    |         |                                    |     |                                       |     |
|------------------------------------|---------|------------------------------------|-----|---------------------------------------|-----|
| Air Gauge Holder.....              | 325     | Combo Y-Drive Wrench.....          | 328 | Fork Cap Socket 41mm HD.....          | 363 |
| ATV Axle Wrench                    |         | Compression Adjuster.....          | 338 | Fork Cap Socket 49mm.....             | 364 |
| Set 45.5mm & 56mm.....             | 353     | Compression Bolt Removal           |     | Fork Cap Tool.....                    | 359 |
| Auxiliary Tank.....                | 342     | Tool For Wp 4860 Mxma Cc.....      | 324 | Fork Cap Tool For Kyb, 49mm.....      | 327 |
| Ball End Allen Set.....            | 333     | Compression Tester With 10mm,      |     | Fork Cap Wrench 49mm.....             | 361 |
| Barbed Fitting Brass.....          | 530     | 12mm And 14mm Adapters.....        | 337 | Fork Cap Wrench 49mm / 50mm....       | 363 |
| Barrel Nipple.....                 | 357-358 | Coolant Recovery Tank 275cc.....   | 347 | Fork Cap Wrench 50mm.....             | 364 |
| Bead Buddy.....                    | 344     | Cooling System Tester, Type A..... | 337 | Fork Cap Wrench                       |     |
| Bearing Driver.....                | 322     | Cooling System Tester,             |     | 50mm / 14mm.....                      | 363 |
| Bearing Remover.....               | 325     | Type A Adapter.....                | 345 | Fork Compression                      |     |
| Belt Tension Gauge.....            | 323     | Counter Balancer & Clutch          |     | Valve Removal Tool.....               | 360 |
| Blind Bearing Remover Kit.....     | 340     | Hub Spanner For Honda 20mm.....    | 347 | Fork Hex Tool 22mm.....               | 363 |
| BPF Rod Guide Wrench.....          | 354     | Counter Shaft Seal Puller.....     | 331 | Fork Seal Bullet.....                 | 322 |
| Braided Vinyl Fuel Line.....       | 528     | Crankcase Splitter V2.....         | 355 | Fork Spring Tool For HD.....          | 360 |
| Break Caliper Piston Tool.....     | 340     | Crankshaft Puller.....             | 330 | Fuel Filter - 6mm.....                | 532 |
| Cable Adjuster.....                | 354     | Cross Point 1/4" Hex-Drive Bit,    |     | Fuel Injector Cleaner.....            | 247 |
| Cable Ball Fittings.....           | 358     | Size No 1.....                     | 357 | Fuel Injector Cleaner                 |     |
| Cable Housing                      |         | Damper Rob Fork Tool.....          | 352 | Kit For Ev1.....                      | 351 |
| Black 50' 5mm,6mm,7mm.....         | 359     | Damping Rod Holder.....            | 342 | Fuel Injector Cleaner                 |     |
| Cable Lube.....                    | 247     | Degree Wheel.....                  | 332 | Kit For Evg.....                      | 351 |
| Carburetor Adapter Top.....        | 367     | Deluxe Auxiliary Tank.....         | 321 | Fuel Injector Cleaner                 |     |
| Carburetor Adjuster Screw.....     | 354     | Deluxe Piston Pin Puller.....      | 347 | Kit For Hv2.....                      | 351 |
| Carburetor Angle Adjuster.....     | 359     | Deluxe Suspension Bearing          |     | Fuel Injector Cleaner Kit For Nd..... | 350 |
| Carburetor End Nipple.....         | 357     | Service Kit.....                   | 323 | Fuel Injector Cleaner Kit For Nyb...  | 350 |
| Carburetor Tool 90 Degree W/Bits   | 321     | Digital 4-Stroke Leak              |     | Fuel Injector Cleaner Pigtail.....    | 349 |
| Carburetor Tuner Brush             |         | Down Tester.....                   | 337 | Fuel Line Clamp With Fitting Kit..... | 325 |
| Adapters 5mm, 6mm.....             | 368     | Digital Tire Pressure              |     | Fuel Valve 5/16".....                 | 530 |
| Chain Alignment Tool.....          | 344     | Gauge 60Psi.....                   | 366 | Gasket Scraper.....                   | 356 |
| Chain Breaker & Riveting Tool..... | 344     | Dowel Pin Puller Set.....          | 347 | Gear Jammer.....                      | 346 |
| Chain Breaker With                 |         | D-Shape Bit F/Use                  |     | Grip Glue Adhesive.....               | 247 |
| Folding Handle.....                | 344     | With 08-0220.....                  | 347 | Hardwar Kit, Metric                   |     |
| Chain Breaker, Press And           |         | Dual Ignition System Tester.....   | 332 | Euro 54 Piece Set.....                | 358 |
| Riveting Tool.....                 | 343     | Enduro Pro Tire Iron Set.....      | 365 | Heavy Duty Pin Spanner.....           | 335 |
| Chain Brush.....                   | 345     | Ergo Spoke Wrench                  |     | Heavy Duty Spring Hook.....           | 332 |
| Chain Tension Hardware Kit.....    | 346     | 5mm,6mm,6.5mm,6.8mm,7mm.....       | 364 | Heavy-Duty Clutch Holder Tool.....    | 338 |
| Classic Spoke Wrench               |         | Ergo Spoke Wrench,                 |     | Hex Axle Tool 17,19,22,24mm.....      | 334 |
| 5.0 / 7.0mm.....                   | 328     | Spline Drive.....                  | 357 | Hose Clamps.....                      | 342 |
| Classic Spoke Wrench               |         | FCR Carburetor Tool.....           | 341 | Hose Removal Tool.....                | 356 |
| 6/6.3mm / 6.5/6.9mm.....           | 332     | Fittings Bs-1201 Pk10.....         | 353 | Hose Shears.....                      | 531 |
| Classic Spoke Wrench Set.....      | 366     | Fittings Sg-145 Pk10.....          | 353 | Housing End 7mm.....                  | 358 |
| Clear PVC Vent Hose.....           | 528     | Fly Wheel Puller.....              | 334 | Hydraulic Brake Bleeder.....          | 333 |
| Clip-On Handle-Bar                 |         | Fly Wheel Puller.....              | 334 | Idle Screw Only Mik Carburetor.....   | 341 |
| Alignment Tool.....                | 357     | Fork Alignment Tool.....           | 324 | Inline Fuel Valve.....                | 530 |
| Clutch Holding Tool.....           | 346     | Fork Cap Socket.....               | 362 | Inline Fuel Valve Brass.....          | 530 |
| Combo Metric Tool.....             | 352     | Fork Cap Socket 39mm HD.....       | 364 | Jumbo Chain Tool.....                 | 343 |

|                                                |         |                                                               |     |
|------------------------------------------------|---------|---------------------------------------------------------------|-----|
| Low Permeation                                 |         | Syncro Carburetor Tuner .....                                 | 368 |
| Premium Fuel Line.....                         | 529     | Syncro Fluid Refill.....                                      | 368 |
| Magnetic Nut Driver Set.....                   | 355     | T Connector 3/8 Pk/10.....                                    | 339 |
| Magnetic Pick Up Tool .....                    | 356     | T Handle Bit Driver .....                                     | 329 |
| Main Jet Wrench 6mm Hex .....                  | 341     | T Handle Bit Driver With No. 1,2,3 Jis Cross-Point Bits ..... | 329 |
| Master Link Press .....                        | 345     | T6 Combo Lever 10/12mm .....                                  | 367 |
| Metric Hard Ware Kit .....                     | 360     | T6 Combo Lever Adapter .....                                  | 326 |
| Micro Bleeder .....                            | 362     | T6 Combo Lever Hex Adapter .....                              | 361 |
| Mini Bleeder.....                              | 326     | T6 Combo Lever Set.....                                       | 361 |
| Mini Chain Press Tool.....                     | 345     | T6 Combo Levers .....                                         | 334 |
| Mini-Pro Dual Drive T-Handle .....             | 352     | T6 Trail Bead Buddy .....                                     | 323 |
| Mini-Pro T-Handle Set 8, 10, 12, 13, 14mm..... | 348     | T6 Valve Spring Compressor                                    |     |
| Motion Pro Pliers .....                        | 322     | 18mm, 24mm.....                                               | 349 |
| Motospade .....                                | 352     | T6 Valve Spring Compressor                                    |     |
| Nitro Tape (Black) .....                       | 360     | Adapter 18mm And 28mm .....                                   | 349 |
| Nitrogen Needle Kit .....                      | 362     | T6 Valve Spring Compressor                                    |     |
| Nitrogen Shock Gauge And Filler ..             | 334     | W/ 24mm Adapter .....                                         | 331 |
| Nitrogen Transfer Hose 6 Ft .....              | 367     | Tappet Adjusters .....                                        | 349 |
| Oil Filter And Clutch                          |         | T-Handle Driver 1/4"                                          |     |
| Hub Spanner .....                              | 321     | Drive 3/8" Drive .....                                        | 333 |
| Oil Filter Removal Tool .....                  | 323     | T-Handle Set, 7 Pc Metric .....                               | 348 |
| PBR Chain Tool .....                           | 343     | T-Handle Sockets                                              |     |
| PBR Hollow Nose Rivet Tip .....                | 342     | 8,10,12,19mm.....                                             | 332 |
| Pedal Anchor Kit .....                         | 352     | T-Handle, Ball-End Hex Duel Drive, Metric Set 4,5,6,8mm.....  | 350 |
| Pilot Screw Tool .....                         | 340     | Timing Plug Wrench.....                                       | 349 |
| Pin For Pbr Chain Tool.....                    | 341     | Tire Bead Breaker Tool Set .....                              | 326 |
| Pin Spanner Wrench.....                        | 355     | Tire Bead Breaker Tool Set .....                              | 327 |
| Pivot Suspension Vise .....                    | 330     | Tire Iron Curved 15".....                                     | 366 |
| Premium Fuel Line Black.....                   | 529     | Tire Iron Set 8", 11", 16".....                               | 365 |
| Premium Fuel Line Clear.....                   | 529     | Tire Iron Spoon 10".....                                      | 365 |
| Premium Fuel Line Gray.....                    | 528     | Tire Iron Spoon Set Of 2.....                                 | 363 |
| Pro Air Gauge Chuck .....                      | 367     | Tire Spoons With Axle                                         |     |
| Pro Fill Air Chuck .....                       | 367     | Nut 27mm & 12/13mm.....                                       | 328 |
| Pro Fork Oil Level Tool .....                  | 336     | Titanium Combination Wrench .....                             | 324 |
| Pro Funnel .....                               | 338     | Titanium Combination                                          |     |
| Pro Seal Puller .....                          | 339     | Wrench Set Of 4 .....                                         | 324 |
| Pro Spark Plug Socket 14mm.....                | 335     | Torque Wrench Adapter .....                                   | 356 |
| Pro Spark Plug Socket                          |         | Torx Bit Set .....                                            | 354 |
| 16mm, 18mm, 21mm.....                          | 348     | Trail Task Chain Tool.....                                    | 343 |
| Push Bolt For 08-0058.....                     | 353     | Tri-Drive Mini T-Handle Kit .....                             | 353 |
| Push Pin Tool .....                            | 342     | Turing-Balancing Stand .....                                  | 327 |
| Pushrod Tool For HD .....                      | 357     | Two-Stroke Leak Down Tester .....                             | 332 |
| Quad-Stake Revit Kit .....                     | 333     | U-Joint Press Tool.....                                       | 346 |
| Quick Disconnect                               |         |                                                               |     |
| Single/Dual Shut Off .....                     | 530     |                                                               |     |
| Rack For T-Handle Set .....                    | 335     |                                                               |     |
| Ratchet Spark Plug Wrench .....                | 356     |                                                               |     |
| Ratchet/Socket Spark                           |         |                                                               |     |
| Plug Wrench Kit 13/16".....                    | 353     |                                                               |     |
| Rear Break Kit/ Blaster .....                  | 328     |                                                               |     |
| Rear Wheel Alignment                           |         |                                                               |     |
| Tool For HD.....                               | 348     |                                                               |     |
| Rim Protectors .....                           | 365     |                                                               |     |
| Rim shield .....                               | 366     |                                                               |     |
| Rim Strip Tape .....                           | 361     |                                                               |     |
| Rocker Box Wrench                              |         |                                                               |     |
| 3/16" For HD.....                              | 346     |                                                               |     |
| Rotor And Sprocket Holder .....                | 346     |                                                               |     |
| Sag Scale .....                                | 362     |                                                               |     |
| Seal Mate Fork Seal Cleaner.....               | 339     |                                                               |     |
| Seal Retainer And Ktm                          |         |                                                               |     |
| Fork Cap Tool .....                            | 323     |                                                               |     |
| Shock Bearing Puller .....                     | 336     |                                                               |     |
| Shock Filler.....                              | 366     |                                                               |     |
| Shock setter 14mm.....                         | 365     |                                                               |     |
| Shock Spanner Punch.....                       | 325     |                                                               |     |
| Shock Spring Compressor .....                  | 362     |                                                               |     |
| Side Jaw Pincher Tool .....                    | 531     |                                                               |     |
| Slack master Pro .....                         | 345     |                                                               |     |
| Snap Ring Pliers .....                         | 340     |                                                               |     |
| Snap Ring Plyers .....                         | 333     |                                                               |     |
| Socket Jammer.....                             | 331     |                                                               |     |
| Spanner Nut Socket.....                        | 354-355 |                                                               |     |
| Spark Plug Gap Tool.....                       | 348     |                                                               |     |
| Spark Plug Socket 18mm .....                   | 333     |                                                               |     |
| Spinner T-Handle .....                         | 354     |                                                               |     |
| Spring Hook .....                              | 336     |                                                               |     |
| Stainless Ear Clamps .....                     | 330     |                                                               |     |
| Standard Steel Tire Spoons.....                | 321     |                                                               |     |
| Steering Bearing Installer .....               | 364     |                                                               |     |
| Steering Head Race Puller .....                | 338     |                                                               |     |
| Steering Stem Bearing                          |         |                                                               |     |
| Tool For '14 And Up Bagger.....                | 365     |                                                               |     |
| Steering Stem Took For HD.....                 | 359     |                                                               |     |
| Steering Stem Tool .....                       | 328     |                                                               |     |
| Superlight T6 Hex Axle Tool.....               | 356     |                                                               |     |
| Swingarm Rising Rate                           |         |                                                               |     |
| Linkage Bearing Install Tool.....              | 360     |                                                               |     |

|                                        |     |                                   |                                    |         |
|----------------------------------------|-----|-----------------------------------|------------------------------------|---------|
| U-Joint Separator .....                | 335 | <b>Motion Pro</b>                 | Joker 440 Synthetic Spray.....     | 258     |
| Vacuum Adapters .....                  | 341 | 36mm Axle Socket For HD .....     | Moto Clean Plus .....              | 253     |
| Valve Core Remover .....               | 342 | Fork Seal Driver.....             | Moto Gear Oil .....                | 252     |
| Valve Stem Seal Install Tool .....     | 327 | Micro Bleeder.....                | Moto Protect Spray.....            | 259     |
| Valve Stem Seal Install Tool Kit ..... | 355 | Mini Spring Hook .....            | Moto Quick Cleaner.....            | 253     |
| V-Twin Steering Race Tool.....         | 363 | <b>Motorbike 2T Synthetic Oil</b> | Moto Shine Ms1.....                | 259     |
| Wall Bracket For T-Handle .....        | 335 | Liqui Moly.....                   | Oil Change Kits.....               | 257-258 |
| Wheel Alignment Tool                   |     | <b>Motorbike 4T Oil</b>           | Oil Spray Bio.....                 | 258     |
| For M8 Soft Tail.....                  | 361 | Liqui Moly.....                   | Power Brake Cleaner.....           | 259     |
| Wheel Bearing Removal Set              |     | <b>Motorcycle Techniplate Oil</b> | Power Clean Spray.....             | 259     |
| For HD (3/4 , 1" & 25mm) .....         | 324 | Klotz.....                        | Power Synt 4T Oil.....             | 250     |
| Wheel Bearing Remover .....            | 322 | <b>Motorcycle Tubes</b>           | Prisma Gear Oil .....              | 252     |
| Wheel Bearing Remover                  |     | Bridgestone.....                  | Protex Spray .....                 | 260     |
| 8 Piece Metric Set .....               | 322 | <b>Motorex</b>                    | Racing Bio Air Filter Cleaner..... | 256     |
| XR Bearing Retainer Tool .....         | 339 | Accu Protect Spray.....           | Racing Bio Air Filter Oil.....     | 256     |
| Y Connector 3/16" .....                | 345 | Air Filter Cleaner .....          | Racing Brake Fluid .....           | 257     |
| Yamaha Idle Kit.....                   | 336 | Air Filter Oil.....               | Racing Fork Oil.....               | 254     |
| <b>Motion Pro Pliers</b>               |     | Anti Seize.....                   | Racing Gear Oil .....              | 253     |
| Motion Pro .....                       | 322 | Antirust Spray .....              | Racing Pro 4T Oil .....            | 251     |
| <b>Moto Clean Plus</b>                 |     | ATF Dextron 3.....                | Racing Shock Oil .....             | 254     |
| Motorex.....                           | 253 | ATF Super.....                    | Scooter 4T Oil.....                | 251     |
| <b>Moto Gear Oil</b>                   |     | ATV Quad 4T Oil.....              | Scooter Gear Oil .....             | 252     |
| Motorex.....                           | 252 | Boxer 4T Oil.....                 | Shock Oil .....                    | 254     |
| <b>Moto Glaze</b>                      |     | Brake Cleaner.....                | Silicone Spray.....                | 261     |
| Bikebrite.....                         | 196 | Brake Fluid.....                  | Spray 2000 .....                   | 261     |
| <b>Moto Mask Display</b>               |     | Brake Fluid.....                  | Suspension Cleaner .....           | 261     |
| Bikebrite.....                         | 196 | Carburetor Cleaner.....           | Tire Mounting Fluid .....          | 255     |
| <b>Moto Mask Off</b>                   |     | Chain Clean Degreaser .....       | Trial Gear Oil.....                | 252     |
| Bikebrite.....                         | 196 | Chain Lube .....                  | White Grease.....                  | 255     |
| <b>Moto Mask On</b>                    |     | Coolant .....                     | <b>Motorsport Products</b>         |         |
| Bikebrite.....                         | 196 | Copper Paste.....                 | Engine Stand .....                 | 369     |
| <b>Moto Mask Windscreen</b>            |     | Copper Spray.....                 | Jug Handle.....                    | 369     |
| Bikebrite.....                         | 196 | Cross Power 4T Oil.....           | Oil Tub (Black) .....              | 369     |
| <b>Moto Protect Spray</b>              |     | East Cut Spray.....               | Portable Tire Changer .....        | 370     |
| Motorex.....                           | 259 | Engine Oil .....                  | Portable Tire Changer (Tall).....  | 370     |
| <b>Moto Quick Cleaner</b>              |     | Ethanol Treatment .....           | T-Handle Combo Set .....           | 369     |
| Motorex.....                           | 253 | Fett Grease.....                  | Tire Changer Bead Breaker .....    | 371     |
| <b>Moto Shine Ms1</b>                  |     | Fork Oil .....                    | Tire Iron 10" .....                | 369     |
| Motorex.....                           | 259 | Formula 4T Oil.....               | Tire Iron 13.5" .....              | 370     |
| <b>Motocool Expert</b>                 |     | Gear Oil .....                    | Tire Iron 15" Curved .....         | 370     |
| Motul.....                             | 267 | Grease Spray.....                 | Tire Iron 16" Straight .....       | 370     |
| <b>Motocool Factory Line</b>           |     | Gun Care Spray.....               | <b>Motospade</b>                   |         |
| Motul.....                             | 267 | Helmet Care Spray .....           | Motion Pro .....                   | 352     |
| <b>Motorcycle Techniplate</b>          |     | Hydraulic Fluid.....              | <b>Motul</b>                       |         |
| Klotz.....                             | 207 | Hypoid Gear Oil .....             | 3000 Plus 4T Oil .....             | 262     |
|                                        |     | Intact Mx 50 Spray.....           |                                    |         |

|                                          |         |                                        |         |                                 |     |
|------------------------------------------|---------|----------------------------------------|---------|---------------------------------|-----|
| 300V Factory Line Oil .....              | 262     | <b>MPPI Penetrant Lube</b>             |         | <b>Multipurpose Grease</b>      |     |
| 510 2T Oil .....                         | 262     | Maxima .....                           | 240     | Liqui Moly.....                 | 233 |
| 5100 4T Oil .....                        | 263     | <b>MR20K Wheel Chocks</b>              |         | Performance Tool.....           | 272 |
| 710 2T Oil .....                         | 262     | Caliber .....                          | 305     | <b>Mx4 Techniplate Oil</b>      |     |
| 7100 4T Oil .....                        | 263     | <b>MT 16 Garacross</b>                 |         | Klotz.....                      | 208 |
| 800 Factory Line 2T Oil .....            | 262     | Pirelli .....                          | 94      | <b>Mystik</b>                   |     |
| 90 Pa Gear Oil .....                     | 265     | <b>MT 21 Rallycross</b>                |         | Lubriplate Assembly Grease..... | 270 |
| Brake Fluid.....                         | 266     | Pirelli .....                          | 91      | Marine Grease .....             | 270 |
| C1 Chain Clean .....                     | 266     | <b>MT 43 Pro Trail</b>                 |         |                                 |     |
| C5 Chain Paste.....                      | 266     | Pirelli .....                          | 94      |                                 |     |
| Chain Care Lube.....                     | 267     | <b>MT 60</b>                           |         |                                 |     |
| E10 Shine & Go Spray.....                | 267     | Pirelli .....                          | 91      |                                 |     |
| E2 Moto Wash .....                       | 267     | <b>MT 60 RS</b>                        |         |                                 |     |
| E7 Insect Remover .....                  | 267     | Pirelli .....                          | 93      |                                 |     |
| E9 Wash & Wax Spray .....                | 267     | <b>MT 66 Route</b>                     |         |                                 |     |
| Engine Oil .....                         | 262-269 | Pirelli .....                          | 58      |                                 |     |
| Fork Oil .....                           | 266     | <b>MT 911</b>                          |         |                                 |     |
| Gear 300 Oil .....                       | 265     | ITP .....                              | 120     |                                 |     |
| Gear Competition.....                    | 264     | <b>MU511/MU521</b>                     |         |                                 |     |
| Gear Oil .....                           | 264-265 | Maxxis.....                            | 140     |                                 |     |
| Gearbox Oil.....                         | 265     | <b>Mud Axe</b>                         |         |                                 |     |
| HD 80W90 Gear Oil.....                   | 265     | Risk.....                              | 412     |                                 |     |
| Motocool Expert.....                     | 267     | <b>Mud Lite 2</b>                      |         |                                 |     |
| Motocool Factory Line .....              | 267     | ITP .....                              | 114     |                                 |     |
| Off Road Chain Care Kit.....             | 268     | <b>Mud Lite At</b>                     |         |                                 |     |
| Road Chain Care Kit.....                 | 268     | ITP .....                              | 115     |                                 |     |
| Scooter Expert 2T Oil .....              | 264     | <b>Mud Lite Sp</b>                     |         |                                 |     |
| Scooter Expert 4T Oil .....              | 263     | ITP .....                              | 114     |                                 |     |
| Scooter Power 2T Oil.....                | 264     | <b>Mud Lite XI</b>                     |         |                                 |     |
| Scooter Power 4T Oil.....                | 264     | ITP .....                              | 114     |                                 |     |
| Shock Oil .....                          | 266     | <b>Mud Lite XTR</b>                    |         |                                 |     |
| Snow Power Synth 2T Oil.....             | 265     | ITP .....                              | 115     |                                 |     |
| Snowpower Synth 2T Oil .....             | 265     | <b>Mud Lite XXL</b>                    |         |                                 |     |
| Snowpower Synth 4T Oil .....             | 265     | ITP .....                              | 115     |                                 |     |
| Transoil .....                           | 265     | <b>Muffler Plugs</b>                   |         |                                 |     |
| Transoil Expert.....                     | 265     | Polisport.....                         | 408     |                                 |     |
| Twin Gear & Chaincase Oil.....           | 264     | <b>Multi Purpose Lift Jack</b>         |         |                                 |     |
| Twin Motor Oil.....                      | 264     | Performance Tool.....                  | 398     |                                 |     |
| Twin Primary Chain Case Oil.....         | 264     | <b>Multi-Grip Screw 33/Pack</b>        |         |                                 |     |
|                                          |         | Caliber .....                          | 305     |                                 |     |
| <b>Mounting Flange</b>                   |         | <b>Multi-Grip Screw 8/Pack</b>         |         |                                 |     |
| Mikuni .....                             | 504     | Caliber .....                          | 305     |                                 |     |
| <b>Moving Equipment</b>                  |         | <b>Multiple Outlet Battery Charger</b> |         |                                 |     |
| Caliber .....                            | 305     | Deltran .....                          | 436-437 |                                 |     |
| <b>MPI Motion Activated Light System</b> |         | Noco .....                             | 446-448 |                                 |     |
| Risk.....                                | 415     |                                        |         |                                 |     |

## N

|                                  |                   |
|----------------------------------|-------------------|
| <b>Needle Hose Adapter</b>       |                   |
| Performance Tool.....            | 386               |
| <b>Needle Jet</b>                |                   |
| Mikuni .....                     | 526               |
| <b>Needle Jet - Bleeder Type</b> |                   |
| Mikuni .....                     | 522               |
| <b>Needle Jet - Primary Type</b> |                   |
| Mikuni .....                     | 522               |
| <b>Needle Jet Cy Series</b>      |                   |
| Keihin.....                      | 501               |
| <b>Needle Jet E Cii[P</b>        |                   |
| Mikuni .....                     | 510               |
| <b>Needle Jet Setter</b>         |                   |
| Mikuni .....                     | 521               |
| <b>Needle Jet Setter O Ring</b>  |                   |
| Mikuni .....                     | 510               |
| <b>Needle Jets</b>               |                   |
| Mikuni .....                     | 507               |
| <b>Needle Valve</b>              |                   |
| Keihin.....                      | 491               |
| <b>Needle Valve</b>              |                   |
| Mikuni .....                     | 517               |
| <b>Needle Valve Assembly</b>     |                   |
| Mikuni .....                     | 503-504, 506, 518 |
| <b>Needle Valve Oring</b>        |                   |
| Mikuni .....                     | 509               |
| <b>Needle Valve Washer</b>       |                   |
| Mikuni .....                     | 518               |
| <b>NGK Style Spark Plug Cap</b>  |                   |
| Psychic .....                    | 409               |
| <b>Night Dragon</b>              |                   |
| Pirelli .....                    | 58                |
| <b>Night Dragon GT</b>           |                   |
| Pirelli .....                    | 58                |

|                                        |         |
|----------------------------------------|---------|
| <b>Nitrile Gloves</b>                  |         |
| SPI.....                               | 420     |
| <b>Nitro Racing Additive</b>           |         |
| Klotz.....                             | 209     |
| <b>Nitro Tape (Black)</b>              |         |
| Motion Pro .....                       | 360     |
| <b>Nitrogen Needle Kit</b>             |         |
| Motion Pro .....                       | 362     |
| <b>Nitrogen Shock Gauge And Filler</b> |         |
| Motion Pro .....                       | 334     |
| <b>Nitrogen Transfer Hose 6 Ft</b>     |         |
| Motion Pro .....                       | 367     |
| <b>Noco</b>                            |         |
| 10 Ft Extension Cable .....            | 449     |
| 1000 Amp Lithium Boost Pack.....       | 448     |
| 12V Plug Connector.....                | 449     |
| 1500 Amp Lithium Boost Pack.....       | 449     |
| 2000 Amp Lithium Boost Pack.....       | 448     |
| 250 Amp Lithium Battery.....           | 443     |
| 400 Amp Lithium Battery.....           | 443     |
| 400 Amp Lithium Boost Pack.....        | 448     |
| 500 Amp Lithium Battery.....           | 443     |
| 600 Amp Lithium Battery.....           | 444     |
| Battery Clamp Connector .....          | 449     |
| Boost Max Batter Clamps .....          | 450     |
| Boost Max HD Battery Clamp.....        | 450     |
| Boost Max Lithium Jump Starter.....    | 449     |
| Eyelet Terminal Connector.....         | 449     |
| Gen 5X1.....                           | 447     |
| Gen 5X3.....                           | 447     |
| Genius 1 .....                         | 445     |
| Genius 10 .....                        | 445     |
| Genius 2 .....                         | 445     |
| Genius 2X2.....                        | 446     |
| Genius 2X4 .....                       | 446     |
| Genius 5 .....                         | 445     |
| Genpro 10X1 .....                      | 447     |
| Genpro 10X3 .....                      | 447     |
| Genpro 10X4 .....                      | 448     |
| Lithium Boost Pack.....                | 448-449 |
| Multiple Outlet                        |         |
| Battery Charger .....                  | 446-448 |
| Noco Battery Chargers .....            | 445-448 |
| Noco Lithium Batteries.....            | 443-444 |
| On Board Battery Charger .....         | 446-448 |

|                                          |         |
|------------------------------------------|---------|
| <b>Noco Battery Chargers</b>             |         |
| Noco .....                               | 445-448 |
| <b>Noco Lithium Batteries</b>            |         |
| Noco .....                               | 443-444 |
| <b>Novus</b>                             |         |
| Plastic Polish .....                     | 271     |
| Polish Mates .....                       | 271     |
| <b>Nylon Ring</b>                        |         |
| Mikuni .....                             | 526     |
| <b>Octane Booster</b>                    |         |
| Klotz.....                               | 209     |
| Maxima .....                             | 240     |
| <b>Octane Plus</b>                       |         |
| PJ1.....                                 | 278     |
| <b>Oem Color Match Paint</b>             |         |
| PJ1.....                                 | 279     |
| <b>Off Road Chain Care Kit</b>           |         |
| Motul.....                               | 268     |
| <b>Oil Beakers</b>                       |         |
| Polisport.....                           | 408     |
| <b>Oil Change Kits</b>                   |         |
| Klotz.....                               | 217-220 |
| Maxima .....                             | 244-245 |
| Motorex.....                             | 257-258 |
| <b>Oil Filter And Clutch Hub Spanner</b> |         |
| Motion Pro .....                         | 321     |
| <b>Oil Filter Removal Tool</b>           |         |
| Motion Pro .....                         | 323     |
| <b>Oil Spray Bio</b>                     |         |
| Motorex.....                             | 258     |
| <b>Oil Tub (Black)</b>                   |         |
| Motorsport Products .....                | 369     |
| <b>Oiling Tub</b>                        |         |
| Twin Air .....                           | 295     |
| <b>On Board Battery Charger</b>          |         |
| Noco .....                               | 446-448 |
| <b>Original Dirt star</b>                |         |
| D.I.D.....                               | 101     |
| <b>Original Dirt star 18X2.15</b>        |         |
| D.I.D.....                               | 101     |

# O

|                                                   |                   |
|---------------------------------------------------|-------------------|
| <b>Original Dirt star 18X2.50</b>                 |                   |
| D.I.D.....                                        | 102               |
| <b>Original Dirt star 19X1.85</b>                 |                   |
| D.I.D.....                                        | 102               |
| <b>Original Dirt star 19X2.15</b>                 |                   |
| D.I.D.....                                        | 103               |
| <b>Original Dirt star 19X2.50</b>                 |                   |
| D.I.D.....                                        | 103               |
| <b>Original Dirt star 21X1.85</b>                 |                   |
| D.I.D.....                                        | 103               |
| <b>O-Ring</b>                                     |                   |
| Mikuni .....                                      | 513, 515, 517-518 |
| <b>Outboard Techniplate Oil</b>                   |                   |
| Klotz.....                                        | 210               |
| <b>Overflow Hose</b>                              |                   |
| Keihin.....                                       | 496               |
| <b>Oxidation Remover</b>                          |                   |
| Bio-Kleen .....                                   | 198               |
| <b>P</b>                                          |                   |
| <b>Paint Polish</b>                               |                   |
| Liquid Performance.....                           | 223               |
| <b>Parker DT</b>                                  |                   |
| Kenda .....                                       | 75                |
| <b>Patriotic 5.5 Gallon Motorsport Containers</b> |                   |
| VP .....                                          | 428               |
| <b>PBR Chain Tool</b>                             |                   |
| Motion Pro .....                                  | 343               |
| <b>PBR Hollow Nose Rivet Tip</b>                  |                   |
| Motion Pro .....                                  | 342               |
| <b>Peak 2.5 Mountain Track</b>                    |                   |
| Camso .....                                       | 16570             |
| <b>Pedal Anchor Kit</b>                           |                   |
| Motion Pro .....                                  | 352               |
| <b>Perfect Gas/Oil Mixture Measuring Cup</b>      |                   |
| Ratio Rite .....                                  | 410               |
| <b>Performance Piston Pin Puller</b>              |                   |
| EPI.....                                          | 311               |
| <b>Performance Tech Gloves</b>                    |                   |
| Performance Tool.....                             | 404               |
| <b>Performance Tool</b>                           |                   |
| 1/2" Dr 15" Hex Handle.....                       | 375               |
| 1/2" Dr Slick Torque Wrench .....                 | 405               |

# I N D E X

# INDEX

|                                      |     |                                     |     |                                        |     |
|--------------------------------------|-----|-------------------------------------|-----|----------------------------------------|-----|
| 1/2" Drive Torque Wrench.....        | 406 | 2 Ton Hydraulic Bottle Jack .....   | 381 | Mechanics Set .....                    | 377 |
| 1/4" Dr Universal Joint .....        | 376 | 2 Ton Jack Stand .....              | 382 | 3-Jaw Puller .....                     | 405 |
| 1/4" X 3/8" Adapter .....            | 376 | 2" Cup Wire Brush .....             | 393 | 4 PC 3/8" Drive Extension Set.....     | 377 |
| 10 3/8" Dr SAE Socket Set .....      | 407 | 200 PC Self Drilling Screws.....    | 384 | 4" Grease Gun Needle Adapter .....     | 405 |
| 10 PC 1/4" Dr Metric Socket Set..... | 406 | 200 PC Spring Assortment .....      | 384 | 40 Inch 6-Caster Plastic Creeper....   | 383 |
| 10 PC 1/4" Dr SAE Socket Set .....   | 407 | 2-1/2 Ton Garage Jack .....         | 382 | 4-1/2 Inch Angle Grinder.....          | 383 |
| 10 PC 1/4" Drive Dw Socket Set.....  | 377 | 22 PC SAE/Metric                    |     | 4Lb Sledge Hammer.....                 | 373 |
| 10 PC 1/4" Drive socket Set .....    | 377 | Ball End Hex Key Set .....          | 380 | 4-Way Folding Lug Wrench .....         | 383 |
| 10 PC 3/8" Drive Metric Socket Set   | 378 | 24 Led Work Light.....              | 396 | 5 Gallon Air Tank.....                 | 393 |
| 10 PC 3/8" Drive SAE Dw Socket ..    | 378 | 25' Orange Extension Chord.....     | 388 | 5 PC 1/2" Dr Thin Wall Sockets .....   | 391 |
| 10 PC Hex Bit Socket Set.....        | 374 | 26 PC Hose Clamp Assortment.....    | 384 | 5 PC Sp Socket Set .....               | 374 |
| 10 PC Impact Star Bit Socket Set ..  | 391 | 26 PC Key Type Hose                 |     | 5 PC Tapered Extractors.....           | 385 |
| 10 PC Metric Hex Bit Socket Set....  | 374 | Clamp Assortment .....              | 390 | 50 PC Utility Knife Blades.....        | 406 |
| 10 PC T-Handle Key Set.....          | 401 | 285 PC Electrical Repair Kit .....  | 384 | 500 PC Rivet Assortment.....           | 384 |
| 10 PC X 3/8" Met Dw Socket Set....   | 379 | 29 PC. Drill Bit Set                |     | 51 PC 3/8" Drive Mechanic Set .....    | 379 |
| 100 Amp Battery Load Tester .....    | 389 | W/Steel Case .....                  | 383 | 560 PC Cotter Pin Assortment.....      | 384 |
| 100 PC Bit Set .....                 | 381 | 3 in 1 Flashlight.....              | 389 | 6 Inch Digital Caliper.....            | 385 |
| 100 PC Utility Knife Blades.....     | 390 | 3 in 1 Stapler.....                 | 382 | 6 Inch Plastic Caliper .....           | 383 |
| 11 PC Combination Wrench Set.....    | 393 | 3 PC 1/2" Dr Extension Set .....    | 375 | 6 Inch Quick Release C-Clamp .....     | 382 |
| 12 PC Rail Hook Set.....             | 389 | 3 PC 1/2" Dr Wobble                 |     | 6 PC Screwdriver Set .....             | 394 |
| 12 PC Star Bit Socket Set.....       | 406 | Extension Set .....                 | 375 | 61 PC Rivet Gun Set .....              | 395 |
| 12" Flexible Hose .....              | 386 | 3 PC 1/4" Drive Extension Set.....  | 377 | 7 PC Bearing Race & Seal Driver... 385 |     |
| 12" Tool Bag .....                   | 392 | 3 PC 3/8" Drive Wobble              |     | 7 PC Chisel & Punch Set.....           | 380 |
| 120 PC Fuse Assortment.....          | 384 | Extension Set.....                  | 378 | 7 PC Grease Gun Accessory Kit ....     | 385 |
| 120 PC Heat Shrink Tubing Set.....   | 403 | 3 PC Adjustable Wrench Set .....    | 398 | 7 PC Plier Set .....                   | 398 |
| 120 PC Mini Fuse Assortment .....    | 384 | 3 PC Inspection Tool Set .....      | 395 | 7 PC Professional                      |     |
| 1200 PC Nut And                      |     | 3 PC Lock Grip Pliers Set .....     | 373 | Screwdriver Set .....                  | 400 |
| Bolt Assortment.....                 | 384 | 3 PC Pry Bar Set .....              | 374 | 70 PC Grease Fitting A                 |     |
| 120V Led Work light .....            | 407 | 3 PC. Step Drill Bit Set.....       | 383 | ssortment .....                        | 384 |
| 12V Compact Tire Inflator .....      | 372 | 3/8 X 1/2 M Adapter .....           | 375 | 720 PC Washer Assortment.....          | 384 |
| 150 PC Cotter Pin Assortment.....    | 384 | 3/8" Dr Deep Socket .....           | 402 | 7-In-1 Stubby Screwdriver Set.....     | 398 |
| 150 PC Hair Pin Assortment .....     | 384 | 3/8" Dr Universal Joint .....       | 407 | 7Qt Plastic Drain Pan .....            | 404 |
| 150 PC Wing Nut Assortment .....     | 384 | 3/8" Impact Driver W/ Bits.....     | 397 | 7-Way Crimping Tool.....               | 402 |
| 160 PC Wire Terminal                 |     | 3/8" X 1/2" Adapter .....           | 375 | 8 PC 1/2" Dr SAE                       |     |
| Assortment.....                      | 384 | 3/8" X 1/4" Adapter .....           | 378 | Deep Well Socket Set .....             | 376 |
| 16Oz Ball Pein Hammer .....          | 373 | 3/8" X 5/8" Spark Plug Socket ..... | 378 | 8 PC Metric Hex Key Set.....           | 393 |
| 18" Flexible Hose.....               | 386 | 30 Pc Hex Key Wrench Set .....      | 380 | 8 PC Professional                      |     |
| 19 PC 3/8" Drive                     |     | 300 PC E-Clip Assortment.....       | 384 | Screwdriver Set .....                  | 400 |
| Black Socket Set.....                | 379 | 300 PC Snap Ring Assortment .....   | 384 | 8 PC Specialty Pick/Driver Set .....   | 402 |
| 2 In 1 Led Light.....                | 395 | 32 Inch Bin Rail Set .....          | 389 | 9 PC 1/2" Dr Metric Socket Set.....    | 376 |
| 2 In 1 Wire Stripper/Crimper .....   | 387 | 347 PC SAE Nut &                    |     | 9 PC 1/2" Dr SAE Socket Set .....      | 375 |
| 2 PC Flex Funnel.....                | 387 | Bolt Assortment.....                | 384 | 9 PC Metric Hex Socket Set .....       | 391 |
| 2 PC Led Pocket Flashlight .....     | 396 | 347PC Metric Nut/Bolt               |     | 9 PC SAE Impact Hex                    |     |
| 2 PC Pick Set.....                   | 401 | Assortment.....                     | 384 | Socket Set .....                       | 391 |
| 2 Ton Cable Power Puller .....       | 398 | 36 PC 1/4" Drive                    |     | 9.5 Inch Crimping Pliers.....          | 391 |

|                                         |         |
|-----------------------------------------|---------|
| All Purpose Funnels.....                | 399     |
| Aluminum Led Flashlight .....           | 396     |
| Aluminum Polishing Kit.....             | 392     |
| Automatic Wire Strippers .....          | 395     |
| Bar Stool With Swivel Seat.....         | 401     |
| Battery Alternator Tester .....         | 389     |
| Battery Operated Transfer Pump.....     | 392     |
| Battery Terminal Brush .....            | 394     |
| Bearing Packer .....                    | 386     |
| Boot & Shoe Brush .....                 | 390     |
| Break-Away Utility Knife .....          | 403     |
| Cable Tie Assortment 1000Pc .....       | 397     |
| Cable Tie Assortment 250Pc .....        | 397     |
| Cable Ties.....                         | 382     |
| Carbon And Gasket Scraper.....          | 395     |
| Channel Lock Pliers .....               | 373     |
| Claw & Magnetic Retriever .....         | 393     |
| Clear Plastic Bin Dividers .....        | 390     |
| Combo Fingernail<br>Brush W/Magnet..... | 381     |
| Compression Tester.....                 | 385     |
| Deluxe 12V Tester .....                 | 397     |
| Deluxe Compression Tester Kit .....     | 391     |
| Deluxe Siphon Hose .....                | 388     |
| Digital Multimeter .....                | 396     |
| Digital Tire Inflator.....              | 387     |
| Digital Tire Pressure Gauge .....       | 381     |
| Duct Tape.....                          | 399     |
| Electrical Tape .....                   | 399     |
| Feeler Gauges .....                     | 403     |
| Firepoint 1000 Lumen Flashlight .....   | 389     |
| First Aid Kit.....                      | 388     |
| Fluid Pump.....                         | 388     |
| Folding Utility Knife .....             | 374     |
| Funnel W/ 18" Spout.....                | 387     |
| Grease.....                             | 272     |
| Grease Gun .....                        | 380-381 |
| Grease Gun Coupler.....                 | 386     |
| Grease Injector Needle.....             | 404     |
| Heavy Duty Cricut Tester .....          | 398     |
| Heavy Duty Nut Splitter .....           | 402     |
| Hex Bit Socket 5/32 .....               | 406     |
| High Visibility Led Bit Driver.....     | 390     |
| Large Oil Filter Pliers .....           | 403     |
| Led Battery Tester.....                 | 396     |

|                                               |         |
|-----------------------------------------------|---------|
| Led Pen Light.....                            | 388     |
| Magnetic Parts Tray .....                     | 394     |
| Mini Dial Tire Pressure Gauge .....           | 381     |
| Mini Multi Tool .....                         | 379     |
| Mini Razor Scraper.....                       | 380     |
| Mini Tire Inflator .....                      | 373     |
| Multi Purpose Lift Jack.....                  | 398     |
| Multipurpose Grease .....                     | 272     |
| Needle Hose Adapter.....                      | 386     |
| Performance Tech Gloves .....                 | 404     |
| Performance Tool.....                         | 372-407 |
| Performance Tool.....                         | 372-407 |
| Piston Ring Compressor .....                  | 385     |
| Piston Ring Installer.....                    | 401     |
| Plastic Boot Tray.....                        | 393     |
| Plastic Funnel .....                          | 400     |
| Pocket Led Flashlight .....                   | 396     |
| Pocket Magnetic Pickup Tool.....              | 394     |
| Pocket Multi-Tester .....                     | 397     |
| Pocket Screwdriver Combo .....                | 402     |
| Pro Lever Action Grease Gun.....              | 400     |
| Professional Battery Tester.....              | 394     |
| Roll Around Stool.....                        | 406     |
| Rolling Work Seat .....                       | 392     |
| Rubber Mallet .....                           | 374     |
| SAE/Metric Tap And Die Set.....               | 399     |
| Shaker Siphon Hose.....                       | 392     |
| Small Engine Cylinder Hone.....               | 401     |
| Small Oil Filter Pliers .....                 | 387     |
| Snap Ring Plier Set .....                     | 405     |
| Socket Rail.....                              | 376     |
| Soldering Gun Kit.....                        | 405     |
| Spark Plug Gap Gauge.....                     | 404     |
| Spark Plug Gauge And Gap Tool....             | 403     |
| Spark Plug Hole Chaser .....                  | 404     |
| Spark Plug Wire Tester .....                  | 401     |
| Stainless Digital Caliper.....                | 400     |
| Stainless Polishing Kit .....                 | 392     |
| Suction Gun .....                             | 386     |
| Swivel Filter Wrench .....                    | 387     |
| Tear Drop Ratchet<br>1/4", 1/2", 3/8" .....   | 376     |
| Telescoping Pickup Tool .....                 | 402     |
| Telescoping Swivel<br>Inspection Mirror ..... | 394     |

|                                   |     |
|-----------------------------------|-----|
| Tire Hardware Kit 35Pc .....      | 372 |
| Tire Inflator With Led Light..... | 373 |
| Tire Plugs 5Pk, 30Pk .....        | 372 |
| Tire Repair And Maitane Kit.....  | 372 |
| Utility Knife & Blades .....      | 400 |
| Wall Mounted Grease Gun Holder..  | 405 |
| Wire Brush.....                   | 405 |
| Wire Crimper/Stripper .....       | 395 |

#### Permatex

|                               |     |
|-------------------------------|-----|
| Anti-Seize .....              | 273 |
| Battery Cleaner.....          | 274 |
| Brake Cleaner.....            | 274 |
| Chain Lube .....              | 274 |
| Engine Degreaser.....         | 274 |
| Fast Orange Bar Soap.....     | 273 |
| Fast Orange Hand Cleaner..... | 273 |
| Gasket Maker .....            | 273 |
| RTV Gasket Maker .....        | 273 |
| Thread locker.....            | 274 |

#### Phantom Sportscomp

|              |    |
|--------------|----|
| Pirelli..... | 56 |
|--------------|----|

#### Pig Spit

|                                     |     |
|-------------------------------------|-----|
| Fast Detail Spray .....             | 275 |
| Leather Cleaner & Conditioner ..... | 275 |
| Spit Glass & Plexi Cleaner.....     | 275 |
| Spray Cleaner Detailer .....        | 275 |
| Wheel Cleaner.....                  | 275 |

#### Pilot Jets

|              |     |
|--------------|-----|
| EBC .....    | 482 |
| Mikuni ..... | 508 |

#### Pilot Screw Tool

|                  |     |
|------------------|-----|
| Motion Pro ..... | 340 |
|------------------|-----|

#### Pin Float

|              |     |
|--------------|-----|
| Mikuni ..... | 522 |
|--------------|-----|

#### Pin For PBR Chain Tool

|                  |     |
|------------------|-----|
| Motion Pro ..... | 341 |
|------------------|-----|

#### Pin Spanner Wrench

|                  |     |
|------------------|-----|
| Motion Pro ..... | 355 |
|------------------|-----|

#### Pink 5.5 Gallon Motorsport Containers

|          |     |
|----------|-----|
| VP ..... | 428 |
|----------|-----|

#### Pirelli Tires

|                           |    |
|---------------------------|----|
| Angel GT.....             | 57 |
| Angel Scooter .....       | 55 |
| Diablo Power cruiser..... | 59 |
| Diablo Rosso II .....     | 53 |

# INDEX

|                                  |       |                                      |          |                                      |     |
|----------------------------------|-------|--------------------------------------|----------|--------------------------------------|-----|
| Diablo Rosso III .....           | 53    | Caliber .....                        | 305      | <b>Plug Wrench (10-12-14mm)</b>      |     |
| Diablo Rosso IV .....            | 52    | <b>Pivot Suspension Vise</b>         |          | Emgo .....                           | 308 |
| Diablo Rosso IV Corsa .....      | 52    | Motion Pro .....                     | 330      | <b>Plug Wrench Honda 89216-Mr1-0</b> |     |
| Diablo Rosso Scooter .....       | 54    | <b>PJ1</b>                           |          | Emgo .....                           | 309 |
| Diablo Supercorsa SP V3 .....    | 51    | Blue Label Chain Lube .....          | 277      | <b>Plunger Rubber Cap</b>            |     |
| Diablo Supercorsa SP V4 .....    | 51    | Brake Cleaner .....                  | 278      | Mikuni .....                         | 516 |
| Mandrake MT 15 Cruiser .....     | 57    | Cable Lube .....                     | 279      | <b>Pocket Led Flashlight</b>         |     |
| Mid-Hard Stadium .....           | 98    | Carburetor & Choke Cleaner .....     | 278      | Performance Tool .....               | 396 |
| Mid-Soft Stadium .....           | 98    | Clutch Tuner 2T Gear Oil .....       | 277      | <b>Pocket Magnetic Pickup Tool</b>   |     |
| MT 16 Garacross .....            | 94    | Contact Cleaner .....                | 278      | Performance Tool .....               | 394 |
| MT 21 Rallycross .....           | 91    | Fabric Air Filter Oil .....          | 278      | <b>Pocket Multi-Tester</b>           |     |
| MT 43 Pro Trail .....            | 94    | Fabric Filter Care Kit .....         | 279      | Performance Tool .....               | 397 |
| MT 60 .....                      | 91    | Fast Black Engine & Case Paint ..... | 277      | <b>Pocket Screwdriver Combo</b>      |     |
| MT 60 RS .....                   | 93    | Fast Black Epoxy Paint .....         | 276      | Performance Tool .....               | 402 |
| MT 66 Route .....                | 58    | Fast Black Exhaust Paint .....       | 277      | <b>Pocket Tuner</b>                  |     |
| Night Dragon .....               | 58    | Filter Cleaner .....                 | 277      | Mikuni .....                         | 512 |
| Night Dragon GT .....            | 58    | Foam Filter Cleaner .....            | 277      | <b>Polish Mates</b>                  |     |
| Phantom Sportscomp .....         | 56    | Foam Filter Oil .....                | 278      | Novus .....                          | 271 |
| SC 30 .....                      | 55    | Fork Fluid .....                     | 277      | <b>Polishing Soap</b>                |     |
| Scorpion MT 90 A/T .....         | 92    | Goldfire Motor Oil .....             | 276      | S100 .....                           | 281 |
| Scorpion MX Extra X .....        | 96    | High Gloss Clear Acrylic .....       | 279      | <b>Polisport</b>                     |     |
| Scorpion MX Soft .....           | 95    | Octane Plus .....                    | 278      | Muffler Plugs .....                  | 408 |
| Scorpion MX32 Mid Hard .....     | 96    | Oem Color Match Paint .....          | 279      | Oil Beakers .....                    | 408 |
| Scorpion MX32 Mid Soft .....     | 95    | Primer Paint .....                   | 276      | Pro Octane Oil Mixer 250MI .....     | 408 |
| Scorpion Rally .....             | 99    | Pro Brake Cleaner .....              | 279      | <b>Poly Wax</b>                      |     |
| Scorpion Rally STR .....         | 59    | Pro Contact Cleaner .....            | 279      | Liquid Performance .....             | 223 |
| Scorpion Rally STR .....         | 99    | Renew And Protect .....              | 276, 278 | <b>Pop Off Pressure Gauge</b>        |     |
| Scorpion Trail 2 .....           | 92    | Silverfire 4T Oil .....              | 276      | Mikuni .....                         | 503 |
| Scorpion Trail 3 .....           | 93    | Spray & Wash Degreaser .....         | 279      | <b>Pop Off Pump Gauge</b>            |     |
| Scorpion XC Mid Hard .....       | 97    | Super Cleaner .....                  | 278-279  | Mikuni .....                         | 512 |
| Scorpion XC Mid Soft .....       | 97    | Wrinkle Black Paint .....            | 276      | <b>Portable Tire Changer</b>         |     |
| SL 60 .....                      | 54    | <b>Plastic Boot Tray</b>             |          | Motorsport Products .....            | 370 |
| Sport Demon .....                | 56    | Performance Tool .....               | 393      | <b>Portable Tire Changer (Tall)</b>  |     |
| Street tires .....               | 51-59 | <b>Plastic Cap</b>                   |          | Motorsport Products .....            | 370 |
| Tires .....                      | 51-59 | Mikuni .....                         | 526      | <b>Power Brake Cleaner</b>           |     |
| Tubes .....                      | 193   | <b>Plastic Cleaner Protectant</b>    |          | Motorex .....                        | 259 |
| <b>Piston Pin Puller</b>         |       | Plexus .....                         | 280      | <b>Power Clean Spray</b>             |     |
| SLP .....                        | 422   | <b>Plastic Funnel</b>                |          | Motorex .....                        | 259 |
| <b>Piston Ring Compressor</b>    |       | Performance Tool .....               | 400      | <b>Power Pack</b>                    |     |
| Performance Tool .....           | 385   | <b>Plastic Polish</b>                |          | Deltran .....                        | 438 |
| SPI .....                        | 419   | Novus .....                          | 271      | <b>Power Synt 4T Oil</b>             |     |
| <b>Piston Ring Installer</b>     |       | <b>Plate</b>                         |          | Motorex .....                        | 250 |
| Performance Tool .....           | 401   | Mikuni .....                         | 517      | <b>Powersports Wash</b>              |     |
| SPI .....                        | 421   | <b>Plexus</b>                        |          | Liquid Performance .....             | 223 |
| <b>Pivot Pro Universal Dolly</b> |       | Plastic Cleaner Protectant .....     | 280      |                                      |     |

|                                                   |     |
|---------------------------------------------------|-----|
| <b>Premium Fuel Line Black</b>                    |     |
| Motion Pro .....                                  | 529 |
| <b>Premium Fuel Line Clear</b>                    |     |
| Motion Pro .....                                  | 529 |
| <b>Premium Fuel Line Gray</b>                     |     |
| Motion Pro .....                                  | 528 |
| <b>Prep Fluid</b>                                 |     |
| Evans.....                                        | 201 |
| <b>Primary Case Oil</b>                           |     |
| Klotz.....                                        | 214 |
| <b>Primer Bulb Assembly</b>                       |     |
| SPI.....                                          | 537 |
| <b>Primer Kit</b>                                 |     |
| .....                                             | 478 |
| <b>Primer Paint</b>                               |     |
| PJ1.....                                          | 276 |
| <b>Primer Plunger</b>                             |     |
| Dapco .....                                       | 478 |
| <b>Prisma Gear Oil</b>                            |     |
| Motorex.....                                      | 252 |
| <b>Pro Air Gauge Chuck</b>                        |     |
| Motion Pro .....                                  | 367 |
| <b>Pro Brake Cleaner</b>                          |     |
| PJ1.....                                          | 279 |
| <b>Pro Contact Cleaner</b>                        |     |
| PJ1.....                                          | 279 |
| <b>Pro Fill Air Chuck</b>                         |     |
| Motion Pro .....                                  | 367 |
| <b>Pro Fork Oil Level Tool</b>                    |     |
| Motion Pro .....                                  | 336 |
| <b>Pro Funnel</b>                                 |     |
| Motion Pro .....                                  | 338 |
| <b>Pro Lever Action Grease Gun</b>                |     |
| Performance Tool.....                             | 400 |
| <b>Pro Octane Oil Mixer 250MI</b>                 |     |
| Polisport.....                                    | 408 |
| <b>Pro Seal Puller</b>                            |     |
| Motion Pro .....                                  | 339 |
| <b>Pro Spark Plug Socket 14mm</b>                 |     |
| Motion Pro .....                                  | 335 |
| <b>Pro Spark Plug Socket 16mm, 18mm,<br/>21mm</b> |     |
| Motion Pro .....                                  | 348 |
| <b>Professional Battery Tester</b>                |     |
| Performance Tool.....                             | 394 |

|                                |     |
|--------------------------------|-----|
| <b>Protex Spray</b>            |     |
| Motorex.....                   | 260 |
| <b>Psychic</b>                 |     |
| NGK Style Spark Plug Cap.....  | 409 |
| <b>Pulse Pump Rebuild Kits</b> |     |
| Mikuni .....                   | 513 |
| <b>Pump Cover</b>              |     |
| Mikuni .....                   | 507 |
| <b>Push Bolt For 08-0058</b>   |     |
| Motion Pro .....               | 353 |
| <b>Push Pin Tool</b>           |     |
| Motion Pro .....               | 342 |
| <b>Pushrod Tool For HD</b>     |     |
| Motion Pro .....               | 357 |
| <b>PWC Oil</b>                 |     |
| Maxima .....                   | 239 |
| <b>PWC Parts Kit</b>           |     |
| Mikuni .....                   | 512 |

## Q

|                                              |         |
|----------------------------------------------|---------|
| <b>Quad-Stake Revit Kit</b>                  |         |
| Motion Pro .....                             | 333     |
| <b>Quick 2 Mix</b>                           |         |
| Maxima .....                                 | 239     |
| <b>Quick 2 Mix Bottle</b>                    |         |
| Maxima .....                                 | 320     |
| <b>Quick Bond Grip Glue</b>                  |         |
| Renthal .....                                | 282     |
| <b>Quick Change Kits</b>                     |         |
| Maxima .....                                 | 244-245 |
| <b>Quick Detailer</b>                        |         |
| Klotz.....                                   | 216     |
| <b>Quick Disconnect Plug W/ USB Charger</b>  |         |
| Deltran .....                                | 440     |
| <b>Quick Disconnect Ring Terminals</b>       |         |
| Deltran .....                                | 439     |
| <b>Quick Disconnect Single/Dual Shut Off</b> |         |
| Motion Pro .....                             | 530     |
| <b>Qwik Shine</b>                            |         |
| Bio-Kleen .....                              | 198     |

## R

|                                         |         |
|-----------------------------------------|---------|
| <b>R50 Techniplate Oil</b>              |         |
| Klotz.....                              | 212     |
| <b>Raceline</b>                         |         |
| A12-Squad.....                          | 144     |
| A13 Omega Wheel Decal Pack .....        | 152     |
| A13 Omoega.....                         | 148     |
| A14 Alpha .....                         | 145     |
| A14 Alpha V.....                        | 148     |
| A14 Apha Wheel Black<br>Decal Pack..... | 152     |
| A17 Mamba .....                         | 146     |
| A77 Mamba .....                         | 149     |
| A91 Ryno.....                           | 146     |
| A92 Hostage.....                        | 147     |
| A93 Podium .....                        | 147     |
| A94 Krank.....                          | 149     |
| A95 Trophy .....                        | 150     |
| Beadlock Spacer UTV Spacer .....        | 153     |
| Raceline Beadlock Ring.....             | 154     |
| Raceline UTV Cap.....                   | 152     |
| Raceline Wheels.....                    | 144-154 |
| Raceline Wheels Center Caps.....        | 154     |
| Rbl-Bolt1" 20Pcs. Kit.....              | 154     |
| Spline Cs Pack W/Key.....               | 151     |
| UTV A71 Mamba Beadlock Rings ..         | 152     |
| UTV A71 Mamba Beadlock Rings ..         | 153     |
| UTV Red A91 Ryno<br>Beadlock Rings..... | 153     |
| <b>Raceline Beadlock Ring</b>           |         |
| Raceline.....                           | 154     |
| <b>Raceline UTV Cap</b>                 |         |
| Raceline.....                           | 152     |
| <b>Raceline Wheels</b>                  |         |
| Raceline.....                           | 144-154 |
| <b>Raceline Wheels Center Caps</b>      |         |
| Raceline.....                           | 154     |
| <b>Racing Bio Air Filter Cleaner</b>    |         |
| Motorex.....                            | 256     |
| <b>Racing Bio Air Filter Oil</b>        |         |
| Motorex.....                            | 256     |
| <b>Racing Brake Fluid</b>               |         |

# INDEX

|                                                    |     |                                           |                            |         |                    |                                       |
|----------------------------------------------------|-----|-------------------------------------------|----------------------------|---------|--------------------|---------------------------------------|
| Motorex.....                                       | 257 | <b>Red Tubing</b>                         | Helix Racing.....          | 489     | <b>Risk Racing</b> | Black Hose Bender- Utility            |
| <b>Racing Coolant</b>                              |     |                                           |                            |         |                    | Jug Spout.....                        |
| Engine Ice.....                                    | 200 | <b>Regulator/Rectifier Connectors Kit</b> | RM Stator.....             | 417     |                    | EZ 5 Combo Jug.....                   |
| <b>Racing Fork Oil</b>                             |     |                                           |                            |         |                    | EZ Utility Jug.....                   |
| Motorex.....                                       | 254 | <b>Remove All</b>                         | Bio-Kleen.....             | 198     |                    | Flexit 2.0 Flexible Flashlight.....   |
| <b>Racing Gear Oil</b>                             |     | <b>Renew</b>                              | Bio-Kleen.....             | 197     |                    | Flexit Headlamp Pro 650 Lumen....     |
| Motorex.....                                       | 253 |                                           |                            |         |                    | Flexit Pocket Light.....              |
| <b>Racing Pro 4T Oil</b>                           |     | <b>Renew And Protect</b>                  | PJ1.....                   | 276-278 |                    | Flexit Solar Flexible Flashlight..... |
| Motorex.....                                       | 251 |                                           |                            |         |                    | Flexit Under Hood Light.....          |
| <b>Racing Shock Oil</b>                            |     | <b>Renthal</b>                            | Grip Glue.....             | 282     |                    | Fli Pro Telescoping Light.....        |
| Motorex.....                                       | 254 |                                           | Quick Bond Grip Glue.....  | 282     |                    | Magnetic Light Mine.....              |
| <b>Rack For T-Handle Set</b>                       |     | <b>Replacement Lid</b>                    | Ratio Rite.....            | 410     |                    | Magnetic Light Mine Pro.....          |
| Motion Pro.....                                    | 335 |                                           |                            |         |                    | Mobile Task Light.....                |
| <b>Radiator Cleaner</b>                            |     | <b>Re-Start Lithium Batteries</b>         | Antigravity Batteries..... | 469-471 |                    | MPI Motion Activated Light System     |
| Liqui Moly.....                                    | 232 |                                           |                            |         |                    | Mud Axe.....                          |
| <b>Radiator Fin Straightener</b>                   |     | <b>Restore &amp; Shine XTra Cut</b>       | Bio-Kleen.....             | 198     |                    | Risk Racing.....                      |
| Helix.....                                         | 312 |                                           |                            |         |                    | Seal Doctor.....                      |
| <b>Rampage</b>                                     |     | <b>Retail Rack</b>                        | Bikebrite.....             | 196     |                    | Stkr Flexit Headlamp 300 Lumen ...    |
| Maxxis.....                                        | 141 |                                           |                            |         |                    | Stkr Fli Telescoping Light 10'.....   |
| <b>Ratchet Spark Plug Wrench</b>                   |     | <b>Retroactive K676</b>                   | Kenda.....                 | 42      |                    | Stkr Fli Telescoping Light 6.5'.....  |
| Motion Pro.....                                    | 356 |                                           |                            |         |                    | Telescoping 360 Area Light.....       |
| <b>Ratchet Wire Crimping Pliers- 9In</b>           |     | <b>Ride-On</b>                            | Ride-On.....               | 203     |                    | Trilight Motion Activated.....        |
| RM Stator.....                                     | 416 |                                           | Tire Balancer.....         | 203     |                    | Trilight V2.....                      |
| <b>Ratchet/Socket Spark Plug Wrench Kit 13/16"</b> |     |                                           | Tire Sealant.....          | 203     |                    | Trimobile Work Light.....             |
| Motion Pro.....                                    | 353 | <b>Rim Protectors</b>                     |                            |         |                    |                                       |
| <b>Ratio Rite</b>                                  |     |                                           |                            |         |                    |                                       |
| Perfect Gas/Oil Mixture                            |     | <b>Rim shield</b>                         |                            |         |                    |                                       |
| Measuring Cup.....                                 | 410 |                                           |                            |         |                    |                                       |
| Ratio Rite.....                                    | 410 | <b>Rim Strip Tape</b>                     |                            |         |                    |                                       |
| Replacement Lid.....                               | 410 |                                           |                            |         |                    |                                       |
| <b>Razr</b>                                        |     | <b>Rim Strips</b>                         |                            |         |                    |                                       |
| Maxxis.....                                        | 137 |                                           |                            |         |                    |                                       |
| <b>Razr 2</b>                                      |     | <b>Ring Terminal</b>                      |                            |         |                    |                                       |
| Maxxis.....                                        | 137 |                                           |                            |         |                    |                                       |
| <b>Razr Plus MX</b>                                |     | <b>Ripsaw Full Utility Track</b>          |                            |         |                    |                                       |
| Maxxis.....                                        | 137 |                                           |                            |         |                    |                                       |
| <b>Razr XT</b>                                     |     | <b>Ripsaw II Trail Track</b>              |                            |         |                    |                                       |
| Maxxis.....                                        | 140 |                                           |                            |         |                    |                                       |
| <b>Rbl-Bolt1" 20Pcs. Kit</b>                       |     | <b>Ripsaw II XC Track</b>                 |                            |         |                    |                                       |
| Raceline.....                                      | 154 |                                           |                            |         |                    |                                       |
| <b>Rear Break Kit/ Blaster</b>                     |     | <b>Ripsaw Trail Track</b>                 |                            |         |                    |                                       |
| Motion Pro.....                                    | 328 |                                           |                            |         |                    |                                       |
| <b>Rear Wheel Alignment Tool For HD</b>            |     |                                           |                            |         |                    |                                       |
| Motion Pro.....                                    | 348 |                                           |                            |         |                    |                                       |

|                                     |          |                                       |     |                                            |        |
|-------------------------------------|----------|---------------------------------------|-----|--------------------------------------------|--------|
| <b>Roll Around Stool</b>            |          | <b>SAE/Metric Tap And Die Set</b>     |     | <b>Scooter Power 2T Oil</b>                |        |
| Performance Tool.....               | 406      | Performance Tool.....                 | 399 | Motul.....                                 | 264    |
| <b>Rolling Work Seat</b>            |          | <b>Safety Wire .032 Dia Stainless</b> |     | <b>Scooter Power 4T Oil</b>                |        |
| Performance Tool.....               | 392      | Helix.....                            | 313 | Motul.....                                 | 264    |
| <b>Rotor And Sprocket Holder</b>    |          | <b>Sag Scale</b>                      |     | <b>Scooter Tires</b>                       |        |
| Motion Pro.....                     | 346      | Motion Pro.....                       | 362 | Bridgestone.....                           | 22-24  |
| <b>Round Main Jet</b>               |          | <b>Salt Kleen</b>                     |     | <b>Scorpion MT 90 A/T</b>                  |        |
| Keihin.....                         | 497      | Bio-Kleen.....                        | 198 | Pirelli.....                               | 92     |
| <b>Round Main Jets</b>              |          | <b>Salt Off Concentrate</b>           |     | <b>Scorpion MX Extra X</b>                 |        |
| Mikuni.....                         | 511-512  | Starbrite.....                        | 288 | Pirelli.....                               | 96     |
| <b>Rover 360 Snowmobile Casters</b> |          | <b>Sand Mad</b>                       |     | <b>Scorpion MX Soft</b>                    |        |
| Caliber.....                        | 305      | Kenda.....                            | 77  | Pirelli.....                               | 95     |
| <b>Roxzilla</b>                     |          | <b>Sand Star</b>                      |     | <b>Scorpion MX32 Mid Hard</b>              |        |
| Maxxis.....                         | 141      | ITP.....                              | 119 | Pirelli.....                               | 96     |
| <b>RTV Gasket Maker</b>             |          | <b>Savage XT</b>                      |     | <b>Scorpion MX32 Mid Soft</b>              |        |
| Permatex.....                       | 273      | ITP.....                              | 117 | Pirelli.....                               | 95     |
| <b>RTV Sealant</b>                  |          | <b>SC 30</b>                          |     | <b>Scorpion Rally</b>                      |        |
| Threebond.....                      | 291-293  | Pirelli.....                          | 55  | Pirelli.....                               | 99     |
| <b>Rubber Adhesive</b>              |          | <b>SC1</b>                            |     | <b>Scorpion Rally STR</b>                  |        |
| Threebond.....                      | 293      | Maxima.....                           | 242 | Pirelli.....                               | 59, 99 |
| <b>Rubber Cap</b>                   |          | <b>SC1 Air Freshener</b>              |     | <b>Scorpion Trail 2</b>                    |        |
| Mikuni.....                         | 515      | Maxima.....                           | 243 | Pirelli.....                               | 92     |
| <b>Rubber Flange</b>                |          | <b>SC-1 Lithium Battery</b>           |     | <b>Scorpion Trail 3</b>                    |        |
| Mikuni.....                         | 523, 525 | Antigravity Batteries.....            | 470 | Pirelli.....                               | 93     |
| <b>Rubber Mallet</b>                |          | <b>Scooter 433</b>                    |     | <b>Scorpion XC Mid Hard</b>                |        |
| Performance Tool.....               | 374      | Kenda.....                            | 44  | Pirelli.....                               | 97     |
|                                     |          | <b>Scooter 434</b>                    |     | <b>Scorpion XC Mid Soft</b>                |        |
|                                     |          | Kenda.....                            | 44  | Pirelli.....                               | 97     |
|                                     |          | <b>Scooter 4T Oil</b>                 |     | <b>Screwdriver Valve Stem Tool</b>         |        |
|                                     |          | Motorex.....                          | 251 | Helix.....                                 | 312    |
|                                     |          | <b>Scooter Expert 2T Oil</b>          |     | <b>Screw-In Filter 1/4"</b>                |        |
|                                     |          | Motul.....                            | 264 | SPI.....                                   | 537    |
|                                     |          | <b>Scooter Expert 4T Oil</b>          |     | <b>Sd Beadlock Cap</b>                     |        |
|                                     |          | Motul.....                            | 263 | ITP.....                                   | 125    |
|                                     |          | <b>Scooter Gear Oil</b>               |     | <b>Seal Doctor</b>                         |        |
|                                     |          | Maxima.....                           | 243 | Risk.....                                  | 412    |
|                                     |          | Motorex.....                          | 252 | <b>Seal Mate Fork Seal Cleaner</b>         |        |
|                                     |          | <b>Scooter K329</b>                   |     | Motion Pro.....                            | 339    |
|                                     |          | Kenda.....                            | 45  | <b>Seal Retainer And Ktm Fork Cap Tool</b> |        |
|                                     |          | <b>Scooter K413</b>                   |     | Motion Pro.....                            | 323    |
|                                     |          | Kenda.....                            | 45  | <b>Service Drum Oil</b>                    |        |
|                                     |          | <b>Scooter K453</b>                   |     | Maxima.....                                | 243    |
|                                     |          | Kenda.....                            | 44  | <b>Shaker Siphon Hose</b>                  |        |
|                                     |          | <b>Scooter K761</b>                   |     | Performance Tool.....                      | 392    |
|                                     |          | Kenda.....                            | 44  |                                            |        |

## S

# INDEX

|                                 |                                       |                                          |
|---------------------------------|---------------------------------------|------------------------------------------|
| <b>Sharpening Wheel</b>         | <b>SLP</b>                            | <b>Socket Rail</b>                       |
| Woody's .....429                | Drive Clutch Holding Tool.....422     | Performance Tool .....376                |
| <b>Shine Enhancer Cleanser</b>  | Piston Pin Puller .....422            | <b>Solar Controller</b>                  |
| S100.....282                    | Universal HD Flywheel Piller .....422 | Deltran .....438                         |
| <b>Shock Absorber Oil</b>       | <b>Slydz-On</b>                       | <b>Soldering Gun Kit</b>                 |
| Liqui Moly..... 230-231         | Caliber .....199                      | Performance Tool .....405                |
| <b>Shock Adjustment Tool</b>    | <b>Small Engine Cylinder Hone</b>     | <b>Southwick 2</b>                       |
| SPI.....420                     | Performance Tool .....401             | Kenda.....76                             |
| <b>Shock Bearing Puller</b>     | <b>Small Oil Filter Pliers</b>        | <b>Spak Plug Hole Chaser</b>             |
| Motion Pro.....336              | Performance Tool .....387             | Performance Tool .....404                |
| <b>Shock Filler</b>             | <b>Small Round Jet</b>                | <b>Spanner Nut Socket</b>                |
| Motion Pro.....366              | Mikuni .....504                       | Motion Pro..... 354-355                  |
| <b>Shock Fluid</b>              | <b>Small Round Main Jet</b>           | <b>Spark Plug Gap Gauge</b>              |
| Maxima..... 240-245             | Mikuni .....503                       | Performance Tool .....404                |
| Sta-Bil .....285                | <b>Smooth Needle Jet</b>              | <b>Spark Plug Gap Tool</b>               |
| <b>Shock Oil</b>                | Mikuni .....521                       | Motion Pro.....348                       |
| Motorex .....254                | <b>Snap &amp; Zipper Lubricant</b>    | <b>Spark Plug Gauge And Gap Tool</b>     |
| Motul.....266                   | Starbrite.....290                     | Performance Tool .....403                |
| <b>Shock setter 14mm</b>        | <b>Snap Ring Plier Set</b>            | <b>Spark Plug Socket 18mm</b>            |
| Motion Pro.....365              | Performance Tool .....405             | Motion Pro.....333                       |
| <b>Shock Spanner Punch</b>      | <b>Snap Ring Pliers</b>               | <b>Spark Plug Wire Tester</b>            |
| Motion Pro.....325              | Motion Pro.....340                    | Performance Tool .....401                |
| <b>Shock Spring Compressor</b>  | <b>Snap Ring Pliers</b>               | <b>Special Surfaces Cleaner</b>          |
| Motion Pro.....362              | Motion Pro.....333                    | S100.....282                             |
| <b>Shop Packs</b>               | <b>Snow 4T</b>                        | <b>Speed Fuel Additive</b>               |
| Counteract .....307             | Maxima.....246                        | Liqui Moly .....231                      |
| <b>Side Jaw Pincher Tool</b>    | <b>Snow Power Synth 2T Oil</b>        | <b>Speed Fuel Shooter</b>                |
| Motion Pro.....531              | Motul.....265                         | Liqui Moly .....232                      |
| <b>Silicone Spray</b>           | <b>Snow Stuff</b>                     | <b>Speed Wax</b>                         |
| Motorex .....261                | Deluxe Spring Tool .....319           | Maxima.....241                           |
| <b>Silverfire 4T Oil</b>        | Deluxe Spring Tool Multi-Pack.....319 | <b>SPI</b>                               |
| PJ1 .....276                    | <b>Snowmobile Motor Oil</b>           | Air Filter .....536                      |
| <b>Skicraft Techniplate Oil</b> | Liqui Moly ..... 224-228              | Cable Ties.....420                       |
| Klotz.....211                   | <b>Snowmobile Oil</b>                 | Cable Ties.....420                       |
| SL 60.....                      | Maxima.....239                        | Chain Pocket Saw .....421                |
| Pirelli .....54                 | <b>Snowmobile Techniplate</b>         | Choke Conversion Kit .....484            |
| <b>Slack master Pro</b>         | Klotz.....207                         | Double Folding Shovel.....421            |
| Motion Pro.....345              | <b>Snowpower Synth 2T Oil</b>         | Exhaust Spring Tool.....420              |
| <b>Sled wheels</b>              | Motul.....265                         | Exhaust Spring Tool Round Handle 420     |
| Caliber .....305                | <b>Snowpower Synth 4T Oil</b>         | Extra Large In-Line Fuel Filter.....536  |
| <b>Sledbrite Krystal View</b>   | Motul.....265                         | Fuel Line Clip 3/16" 1/4" 5/16" .....535 |
| Bio-Kleen .....197              | <b>Snowx4 Engine Lubricant</b>        | Fuel Line - Blue.....534                 |
| <b>Slow Jet</b>                 | Klotz.....216                         | Fuel Line - Clear .....535               |
| EBC .....482                    | <b>Socket Jammer</b>                  | Fuel Line Clip 1/4".....535              |
| Keihin.....497                  | Motion Pro.....331                    | Fuel Line Clip 3/16".....535             |

|                                             |          |                                            |          |                                                  |     |
|---------------------------------------------|----------|--------------------------------------------|----------|--------------------------------------------------|-----|
| Heavy Duty Track Clip Tool.....             | 419      | Mikuni.....                                | 515, 517 | Motion Pro.....                                  | 330 |
| Hose Bender 1" O.D. Hose.....               | 419      | <b>Spring Hook</b>                         |          | <b>Stainless Polishing Kit</b>                   |     |
| Hose Benders .....                          | 419      | Motion Pro.....                            | 336      | Performance Tool .....                           | 392 |
| In-Line Fuel Filter .....                   | 536      | <b>Spring Plate</b>                        |          | <b>Standard Cam Shaft Installation Kit</b>       |     |
| In-Line Fuel Filter 1/4" .....              | 534, 537 | Mikuni .....                               | 523      | Hotcams.....                                     | 316 |
| In-Line Fuel Filter 5/16" .....             | 534      | <b>Spring Pull Tool</b>                    |          | <b>Standard Container Hose</b>                   |     |
| In-Tank Fuel Filter For 1/4" Fuel Line..... | 536      | Helix.....                                 | 312      | VP .....                                         | 427 |
| In-Tank Fuel Filter For 3/8" Fuel Line..... | 535      | <b>Spring Seat Plate</b>                   |          | <b>Standard Steel Tire Spoons</b>                |     |
| Leak Down Tester .....                      | 419      | Mikuni .....                               | 523-524  | Motion Pro.....                                  | 321 |
| Nitrile Gloves.....                         | 420      | <b>Spring Tools</b>                        |          | <b>Star Tron Sef Fuel Treatment</b>              |     |
| Piston Ring Compressor .....                | 419      | SPI.....                                   | 420      | Starbrite.....                                   | 286 |
| Piston Ring Installer.....                  | 421      | <b>Square Support Plate Tool</b>           |          | <b>Starbrite</b>                                 |     |
| Primer Bulb Assembly .....                  | 537      | Woody's .....                              | 430      | Chrome & Stainless Polish.....                   | 290 |
| Screw-In Filter 1/4" .....                  | 537      | <b>SS Alloy Chrome Cap</b>                 |          | Microfiber Wash Mitt .....                       | 287 |
| Shock Adjustment Tool .....                 | 420      | ITP.....                                   | 123      | Salt Off Concentrate.....                        | 288 |
| SPI Tools .....                             | 419-421  | <b>SS Alloy SS 216 &amp; 316 Black Cap</b> |          | Snap & Zipper Lubricant.....                     | 290 |
| Spring Tools .....                          | 420      | ITP.....                                   | 123      | Star Tron Sef Fuel Treatment.....                | 286 |
| Syphon Hose .....                           | 419      | <b>SS Alloy SS212</b>                      |          | Star-Cool Engine Coolant .....                   | 286 |
| Terminal Removal Tool Kit .....             | 419      | ITP.....                                   | 122      | Ultimate Bike Guard.....                         | 289 |
| Universal In-Line Fuel Filter .....         | 537      | <b>SS Alloy SS312</b>                      |          | Ultimate Citrus                                  |     |
| Universal In-Tank Fuel Filter.....          | 537      | ITP.....                                   | 122      | Cleaner & Degreaser.....                         | 287 |
| Universal Track Clip Tool.....              | 420      | <b>SS Alloy SS316</b>                      |          | Ultimate Corrosion Blocker.....                  | 287 |
| Walbro Type In-Line Fuel Filter.....        | 536      | ITP.....                                   | 123      | Ultimate Fabric Guard.....                       | 289 |
| Y Fitting .....                             | 536      | <b>SS Alloy Tall Viking/Wolverine Cap</b>  |          | Ultimate Lubricating Fluid.....                  | 290 |
| <b>Spinner T-Handle</b>                     |          | ITP.....                                   | 122      | Ultimate Magic Sponge.....                       | 287 |
| Motion Pro.....                             | 354      | <b>Sta-Bil</b>                             |          | Ultimate Matte Finish Detailer .....             | 290 |
| <b>Spit Glass &amp; Plexi Cleaner</b>       |          | Carburetor & Choke Cleaner.....            | 285      | Ultimate Water Spot Remover.....                 | 289 |
| Pig Spit .....                              | 275      | Fogging Oil .....                          | 285      | Ultimate XTreme Clean .....                      | 288 |
| <b>Spline Cs Pack W/Key</b>                 |          | Fork Fluid.....                            | 285      | <b>Star-Cool Engine Coolant</b>                  |     |
| Raceline.....                               | 151      | Fuel Stabilizer.....                       | 283-284  | Starbrite.....                                   | 286 |
| <b>Spoke Wrench 6-Way</b>                   |          | Gold Eagle .....                           | 202      | <b>Starter Lever</b>                             |     |
| Emgo.....                                   | 309      | Heet Fuel Line Antifreeze.....             | 284      | Mikuni.....                                      | 504 |
| <b>Sport Demon</b>                          |          | Iso-Heat Water Remover .....               | 284      | <b>Starter Lever</b>                             |     |
| Pirelli.....                                | 56       | Marine Formula Ethanol                     |          | Mikuni .....                                     | 519 |
| <b>Spray &amp; Wash Degreaser</b>           |          | Treatment.....                             | 283      | <b>Starter Plunger</b>                           |     |
| PJ1 .....                                   | 279      | Shock Fluid.....                           | 285      | Mikuni .....                                     | 515 |
| Spray 2000 .....                            |          | <b>Sta-Bil Carburetor &amp; Choke</b>      |          | <b>Starter Plunger</b>                           |     |
| Motorex.....                                | 261      | Gold Eagle .....                           | 202      | Mikuni .....                                     | 521 |
| <b>Spray Cleaner</b>                        |          | <b>Sta-Bil Fuel Stabilizer</b>             |          | <b>Steering Bearing Installer</b>                |     |
| Bike SPirits.....                           | 272      | Gold Eagle .....                           | 202      | Motion Pro.....                                  | 364 |
| <b>Spray Cleaner Detailer</b>               |          | <b>Sta-Bil Marine</b>                      |          | <b>Steering Head Race Puller</b>                 |     |
| Pig Spit .....                              | 275      | Gold Eagle .....                           | 202      | Motion Pro.....                                  | 338 |
| <b>Spring</b>                               |          | <b>Stainless Digital Caliper</b>           |          | <b>Steering Stem Bearing Tool For '14 And Up</b> |     |
|                                             |          | Performance Tool .....                     | 400      | <b>Bagger</b>                                    |     |
|                                             |          | <b>Stainless Ear Clamps</b>                |          | Motion Pro.....                                  | 365 |

|                                        |       |                                                          |     |                                                         |
|----------------------------------------|-------|----------------------------------------------------------|-----|---------------------------------------------------------|
| <b>Steering Stem Took For HD</b>       |       | <b>Suspension Cleaner</b>                                |     | <b>T6 Valve Spring Compressor 18mm, 24mm</b>            |
| Motion Pro.....                        | 359   | Motorex .....                                            | 261 | Motion Pro .....                                        |
| <b>Steering Stem Tool</b>              |       | <b>Swingarm Rising Rate Linkage Bearing Install Tool</b> |     | Motion Pro .....                                        |
| Motion Pro.....                        | 328   | Motion Pro.....                                          | 360 | <b>T6 Valve Spring Compressor Adapter 18mm And 28mm</b> |
| <b>Stkr Flexit Headlamp 300 Lumen</b>  |       | <b>Swivel Filter Wrench</b>                              |     | Motion Pro .....                                        |
| Risk .....                             | 413   | Performance Tool.....                                    | 387 | <b>T6 Valve Spring Compressor W/ 24mm Adapter</b>       |
| <b>Stkr Fli Telescoping Light 10'</b>  |       | <b>Syncro Carburetor Tuner</b>                           |     | Motion Pro .....                                        |
| Risk .....                             | 413   | Motion Pro.....                                          | 368 | <b>Tappet Adjusters</b>                                 |
| <b>Stkr Fli Telescoping Light 6.5'</b> |       | <b>Syncro Fluid Refill</b>                               |     | Motion Pro .....                                        |
| Risk .....                             | 413   | Motion Pro.....                                          | 368 | <b>Tear Drop Ratchet 1/4", 1/2", 3/8"</b>               |
| <b>Storage Fogging Oil</b>             |       | <b>Synthetic Snowmobile Oil</b>                          |     | Performance Tool.....                                   |
| Lubrimatic .....                       | 236   | Klotz.....                                               | 207 | <b>Telescoping 360 Area Light</b>                       |
| <b>Storbilizer</b>                     |       | <b>Synthetic V-Twin Oil</b>                              |     | Risk.....                                               |
| Klotz.....                             | 215   | Klotz.....                                               | 221 | <b>Telescoping Pickup Tool</b>                          |
| <b>Storm 150 Trail Track</b>           |       | <b>Syphon Hose</b>                                       |     | Performance Tool.....                                   |
| Camso .....                            | 174   | SPI.....                                                 | 419 | <b>Telescoping Swivel Inspection Mirror</b>             |
| <b>Street Bike Wash</b>                |       | <b>System Maintenance Kit</b>                            |     | Performance Tool.....                                   |
| Liquid Performance.....                | 223   | Twin Air.....                                            | 295 | <b>Tenacity</b>                                         |
| <b>Street tires</b>                    |       |                                                          |     | ITP .....                                               |
| Bridgestone.....                       | 9-29  |                                                          |     | <b>Terapump</b>                                         |
| Kenda.....                             | 41-48 |                                                          |     | Transfer Pumps .....                                    |
| Pirelli .....                          | 51-59 |                                                          |     | TRD49ON .....                                           |
| <b>Stud Installation Tool</b>          |       |                                                          |     | TREDRUM-T .....                                         |
| Woody's .....                          | 429   |                                                          |     | TREDRUMT-M.....                                         |
| <b>Suction Gun</b>                     |       |                                                          |     | TREP01-T.....                                           |
| Performance Tool .....                 | 386   |                                                          |     | TREP01-TXL.....                                         |
| <b>Super BN Valve</b>                  |       |                                                          |     | TRFA01.....                                             |
| Mikuni.....                            | 507   |                                                          |     | TRFA01-XL.....                                          |
| <b>Super Cleaner</b>                   |       |                                                          |     | TRFA01-XL-CH.....                                       |
| PJ1 .....                              | 278   |                                                          |     | TRFA03.....                                             |
| PJ1 .....                              | 279   |                                                          |     | TRFA03-XL.....                                          |
| <b>Super Glue</b>                      |       |                                                          |     | TRJ5XLR .....                                           |
| Threebond .....                        | 293   |                                                          |     | <b>Terminal Removal Tool Kit</b>                        |
| <b>Super Suds Wash</b>                 |       |                                                          |     | SPI .....                                               |
| Bio-Kleen .....                        | 198   |                                                          |     | <b>Terra Cross R/T</b>                                  |
| <b>Super Tuff Tubes</b>                |       |                                                          |     | ITP .....                                               |
| Kenda.....                             | 188   |                                                          |     | <b>Terra-Hook</b>                                       |
| <b>Superlight T6 Hex Axle Tool</b>     |       |                                                          |     | ITP .....                                               |
| Motion Pro.....                        | 356   |                                                          |     | <b>T-Handle Combo Set</b>                               |
| <b>Suspa</b>                           |       |                                                          |     | Motorsport Products .....                               |
| 13mm Ball Stud .....                   | 423   |                                                          |     | <b>T-Handle Driver 1/4" Drive 3/8" Drive</b>            |
| Clamshell Prop.....                    | 423   |                                                          |     | Motion Pro .....                                        |
| Trailer Props.....                     | 423   |                                                          |     | <b>T-Handle Set, 7 Pc Metric</b>                        |
| <b>Suspension Clean</b>                |       |                                                          |     | Motion Pro .....                                        |
| Maxima.....                            | 241   |                                                          |     |                                                         |

## T

|                                                                |               |                                        |          |
|----------------------------------------------------------------|---------------|----------------------------------------|----------|
| <b>T-Handle Sockets 8,10,12,19mm</b>                           |               | <b>TM Series Carburetors</b>           |          |
| Motion Pro .....                                               | 332           | Mikuni .....                           | 514      |
| <b>T-Handle Spark Plug Wrench</b>                              |               | <b>TM Series Flat Slide Carburetor</b> |          |
| Emgo .....                                                     | 309           | Mikuni .....                           | 521      |
| <b>T-Handle, Ball-End Hex Duel Drive, Metric Set 4,5,6,8mm</b> |               | <b>Tools</b>                           |          |
| Motion Pro .....                                               | 350           | All Balls .....                        | 300      |
| <b>Thread locker</b>                                           |               | <b>Top Chamber Gasket</b>              |          |
| Permatex .....                                                 | 274           | Mikuni .....                           | 525      |
| Threebond .....                                                | 293-294       | <b>Top Cover Gasket</b>                |          |
| <b>Threebond</b>                                               |               | Keihin .....                           | 494      |
| Gasket Maker .....                                             | 291           | Mikuni .....                           | 519      |
| Griplock.....                                                  | 293           | <b>Top Gasket 36mm-44mm</b>            |          |
| Liquid Gasket.....                                             | 293           | Mikuni .....                           | 504      |
| RTV Sealant .....                                              | 291-293       | <b>Top Mixing Chamber</b>              |          |
| Rubber Adhesive .....                                          | 293           | Mikuni .....                           | 506, 524 |
| Super Glue.....                                                | 293           | <b>Top Mixing Chamber Gasket</b>       |          |
| Thread locker.....                                             | 293-294       | Mikuni .....                           | 504      |
| <b>Throttle Bell Lever Crank Pin</b>                           |               | <b>Tornado</b>                         |          |
| Mikuni .....                                                   | 513           | ITP .....                              | 124      |
| <b>Throttle Lever</b>                                          |               | <b>Torque Wrench Adapter</b>           |          |
| Keihin .....                                                   | 490           | Motion Pro .....                       | 356      |
| <b>Throttle Spring</b>                                         |               | <b>Torx Bit Set</b>                    |          |
| Keihin .....                                                   | 493-494       | Motion Pro .....                       | 354      |
| <b>Throttle Stop Screw</b>                                     |               | <b>Total Cycle Cleaner</b>             |          |
| Mikuni .....                                                   | 516           | S100 .....                             | 281      |
| <b>Throttle Valve</b>                                          |               | <b>Track Clip</b>                      |          |
| Mikuni .....                                                   | 523           | Camso .....                            | 177      |
| <b>Throttle Valve Spring</b>                                   |               | <b>Track Clip Tool</b>                 |          |
| Mikuni .....                                                   | 503, 506, 526 | Woody's .....                          | 429      |
| <b>Timing Plug Wrench</b>                                      |               | <b>Track Drill Tool</b>                |          |
| Motion Pro .....                                               | 349           | Woody's .....                          | 429      |
| <b>Tire Balancer</b>                                           |               | <b>Track Marker</b>                    |          |
| Ride-On .....                                                  | 203           | Woody's .....                          | 430      |
| <b>Tire Bead Breaker Tool Set</b>                              |               | <b>Track Tension Tool</b>              |          |
| Motion Pro .....                                               | 326-327       | Woody's .....                          | 429      |
| <b>Tire Changer Bead Breaker</b>                               |               | <b>Track Tools</b>                     |          |
| Motorsport Products .....                                      | 371           | Woody's .....                          | 429-430  |
| <b>Tire Conversion Chart</b>                                   |               | <b>Trail Task Chain Tool</b>           |          |
| Bridgestone.....                                               | 30            | Motion Pro .....                       | 343      |
| <b>Tire Gauge To 8 Psi (Package Of 10)</b>                     |               | <b>Trail Wing</b>                      |          |
| Emgo .....                                                     | 309           | Bridgestone.....                       | 67, 69   |
| <b>Tire Hardware Kit 35Pc</b>                                  |               | <b>Trail Wing TW101/TW152</b>          |          |
| Performance Tool.....                                          | 372           | Bridgestone.....                       | 72       |
| <b>Tire Inflator With Led Light</b>                            |               | <b>Trail Wing TW18</b>                 |          |
| Performance Tool.....                                          | 373           | Bridgestone .....                      | 72       |
|                                                                |               |                                        |          |
| <b>Tire Iron 10"</b>                                           |               |                                        |          |
| Motorsport Products .....                                      | 369           |                                        |          |
| <b>Tire Iron 13.5"</b>                                         |               |                                        |          |
| Motorsport Products .....                                      | 370           |                                        |          |
| <b>Tire Iron 15" Curved</b>                                    |               |                                        |          |
| Motorsport Products .....                                      | 370           |                                        |          |
| <b>Tire Iron 16" Straight</b>                                  |               |                                        |          |
| Motorsport Products .....                                      | 370           |                                        |          |
| <b>Tire Iron Curved 15"</b>                                    |               |                                        |          |
| Motion Pro .....                                               | 366           |                                        |          |
| <b>Tire Iron Set 8", 11", 16"</b>                              |               |                                        |          |
| Motion Pro .....                                               | 365           |                                        |          |
| <b>Tire Iron Spoon 10"</b>                                     |               |                                        |          |
| Motion Pro .....                                               | 365           |                                        |          |
| <b>Tire Iron Spoon Set Of 2</b>                                |               |                                        |          |
| Motion Pro .....                                               | 363           |                                        |          |
| <b>Tire Iron With Rim Protector 380mm</b>                      |               |                                        |          |
| Helix.....                                                     | 313           |                                        |          |
| <b>Tire Mounting Fluid</b>                                     |               |                                        |          |
| Motorex.....                                                   | 255           |                                        |          |
| <b>Tire Plugs 5Pk, 30Pk</b>                                    |               |                                        |          |
| Performance Tool .....                                         | 372           |                                        |          |
| <b>Tire Repair And Maitane Kit</b>                             |               |                                        |          |
| Performance Tool.....                                          | 372           |                                        |          |
| <b>Tire Sealant</b>                                            |               |                                        |          |
| Ride-On .....                                                  | 203           |                                        |          |
| <b>Tire Spoons With Axle Nut 27mm &amp; 12/13mm</b>            |               |                                        |          |
| Motion Pro .....                                               | 328           |                                        |          |
| <b>Tires</b>                                                   |               |                                        |          |
| Bridgestone.....                                               | 9-30          |                                        |          |
| Kenda .....                                                    | 41-48         |                                        |          |
| Pirelli .....                                                  | 51-59         |                                        |          |
| <b>Tiretech</b>                                                |               |                                        |          |
| Tubes .....                                                    | 192           |                                        |          |
| <b>Titanium Combination Wrench</b>                             |               |                                        |          |
| Motion Pro .....                                               | 324           |                                        |          |
| <b>Titanium Combination Wrench Set Of 4</b>                    |               |                                        |          |
| Motion Pro .....                                               | 324           |                                        |          |
| <b>TKC 80 Twin Duro</b>                                        |               |                                        |          |
| Continental.....                                               | 38            |                                        |          |
| <b>TKC 70</b>                                                  |               |                                        |          |
| Continental.....                                               | 37            |                                        |          |
| <b>TKC 70 Rocks</b>                                            |               |                                        |          |
| Continental.....                                               | 38            |                                        |          |

|                               |         |                                     |         |                                                |         |
|-------------------------------|---------|-------------------------------------|---------|------------------------------------------------|---------|
| <b>Trail Wing TW2</b>         |         | <b>Trep01-Txl</b>                   |         | Air Filter Oil.....                            | 295     |
| Bridgestone.....              | 69      | Terapump.....                       | 424     | Air Filter Sealant.....                        | 296     |
| <b>Trail Wing TW301</b>       |         | <b>Trfa01</b>                       |         | Bio Air Filter Cleaner.....                    | 296     |
| Bridgestone.....              | 25      | Terapump.....                       | 425     | Bio Air Filter Oil.....                        | 296     |
| <b>Trail Wing TW301/TW302</b> |         | <b>Trfa01-XI</b>                    |         | Cleaning Tub.....                              | 295     |
| Bridgestone.....              | 72      | Terapump.....                       | 425     | Foaming Power wash.....                        | 296     |
| <b>Trail Wing TW302</b>       |         | <b>Trfa01-XI-Ch</b>                 |         | Heay Duty Wet Power Wipes.....                 | 296     |
| Bridgestone.....              | 25      | Terapump.....                       | 424     | Iceflow High Performance Coolant.....          | 296     |
| <b>Trail Wing TW31</b>        |         | <b>Trfa03</b>                       |         | Oiling Tub.....                                | 295     |
| Bridgestone.....              | 73      | Terapump.....                       | 425     | System Maintenance Kit.....                    | 295     |
| <b>Trail Wing TW34</b>        |         | <b>Trfa03-XI</b>                    |         | <b>Twin Gear &amp; Chaincase Oil</b>           |         |
| Bridgestone.....              | 73      | Terapump.....                       | 425     | Motul.....                                     | 264     |
| <b>Trail Wing TW42</b>        |         | <b>Trial Gear Oil</b>               |         | <b>Twin Motor Oil</b>                          |         |
| Bridgestone.....              | 69, 73  | Motorex.....                        | 252     | Motul.....                                     | 264     |
| <b>Trail Wing TW52</b>        |         | <b>Trickel Charger</b>              |         | <b>Twin Primary Chain Case Oil</b>             |         |
| Bridgestone.....              | 73      | Deltran.....                        | 434-436 | Motul.....                                     | 264     |
| <b>Trail Wing TW9</b>         |         | <b>Tri-Drive Mini T-Handle Kit</b>  |         | <b>Two-Stroke Leak Down Tester</b>             |         |
| Bridgestone.....              | 73      | Motion Pro.....                     | 353     | Motion Pro.....                                | 332     |
| <b>Trailer</b>                |         | <b>Trigger Fluid Control System</b> |         | <b>Tytaneum</b>                                |         |
| .....                         | 157-160 | VP.....                             | 427     | Battery Acid.....                              | 451     |
| <b>Trailer Props</b>          |         | <b>Trilight Motion Activated</b>    |         | Battery Cross Reference                        |         |
| Suspa.....                    | 423     | Risk.....                           | 415     | Chart.....                                     | 454-455 |
| <b>Trakmaster 2</b>           |         | <b>Trilight V2</b>                  |         | Conventional Batteries.....                    | 453     |
| Kenda.....                    | 80      | Risk.....                           | 415     | Maintenance Free Batteries.....                | 451-452 |
| <b>Trakmaster DTR K6342</b>   |         | <b>Trimobile Work Light</b>         |         | Tytaneum Batteries.....                        | 451-455 |
| Kenda.....                    | 48      | Risk.....                           | 412     | <b>Tytaneum Batteries</b>                      |         |
| <b>Transfer Pumps</b>         |         | <b>Tripple</b>                      |         | Tytaneum.....                                  | 451-455 |
| Terapump.....                 | 424-425 | Kenda.....                          | 80      |                                                |         |
| <b>Transmission Oil</b>       |         | <b>Trj5Xlr</b>                      |         |                                                |         |
| Klotz.....                    | 213     | Terapump.....                       | 425     |                                                |         |
| Maxima.....                   | 238-246 | <b>Tubes</b>                        |         |                                                |         |
| <b>Transoil</b>               |         | Bridgestone.....                    | 180-181 |                                                |         |
| Motul.....                    | 265     | Carlstar.....                       | 182     | <b>U-Joint Press Tool</b>                      |         |
| <b>Transoil Expert</b>        |         | Counteract.....                     | 184     | Motion Pro.....                                | 346     |
| Motul.....                    | 265     | Kenda.....                          | 186-190 | <b>U-Joint Separator</b>                       |         |
| <b>Transparent Tubing</b>     |         | Pirelli.....                        | 193     | Motion Pro.....                                | 335     |
| Helix Racing.....             | 488     | Tiretech.....                       | 192     | <b>Ultimate Bike Guard</b>                     |         |
| <b>Trd49On</b>                |         | <b>Tuff Tubes</b>                   |         | Starbrite.....                                 | 289     |
| Terapump.....                 | 424     | Kenda.....                          | 187     | <b>Ultimate Citrus Cleaner &amp; Degreaser</b> |         |
| <b>Tredrum-T</b>              |         | <b>Tundra Snowmobile Oil</b>        |         | Starbrite.....                                 | 287     |
| Terapump.....                 | 424     | Maxima.....                         | 239     | <b>Ultimate Corrosion Blocker</b>              |         |
| <b>Tredrumt-M</b>             |         | <b>Turing-Balancing Stand</b>       |         | Starbrite.....                                 | 287     |
| Terapump.....                 | 424     | Motion Pro.....                     | 327     | <b>Ultimate Fabric Guard</b>                   |         |
| <b>Trep01-T</b>               |         | <b>Twin Air</b>                     |         | Starbrite.....                                 | 289     |
| Terapump.....                 | 424     | Air Filter Cleaner.....             | 295     | <b>Ultimate Lubricating Fluid</b>              |         |
|                               |         |                                     |         | Starbrite.....                                 | 290     |

## U

|                                               |     |
|-----------------------------------------------|-----|
| <b>Ultimate Magic Sponge</b>                  |     |
| Starbrite .....                               | 287 |
| <b>Ultimate Matte Finish Detailer</b>         |     |
| Starbrite .....                               | 290 |
| <b>Ultimate Water Spot Remover</b>            |     |
| Starbrite .....                               | 289 |
| <b>Ultimate XTreme Clean</b>                  |     |
| Starbrite .....                               | 288 |
| <b>Ultra Cross R Spec Race</b>                |     |
| ITP .....                                     | 117 |
| <b>UNI Filter</b>                             |     |
| Foam Filter Cleaner .....                     | 297 |
| Foam Filter Oil .....                         | 297 |
| Foam Filter Service Kit .....                 | 297 |
| <b>Universal Flywheel Puller</b>              |     |
| RM Stator.....                                | 416 |
| <b>Universal Group Trailer Wheel Hub Kits</b> |     |
| Carlisle.....                                 | 157 |
| <b>Universal HD Flywheel Piller</b>           |     |
| SLP .....                                     | 422 |
| <b>Universal In-Line Fuel Filter</b>          |     |
| SPI .....                                     | 537 |
| <b>Universal In-Tank Fuel Filter</b>          |     |
| SPI .....                                     | 537 |
| <b>Universal Track Clip Tool</b>              |     |
| SPI .....                                     | 420 |
| <b>Uplon Fuel Lube</b>                        |     |
| Klotz.....                                    | 208 |
| <b>USB Wall Charger</b>                       |     |
| Deltran .....                                 | 441 |
| <b>Utility Knife &amp; Blades</b>             |     |
| Performance Tool.....                         | 400 |
| <b>UTV A71 Mamba Beadlock Rings</b>           |     |
| Raceline.....                                 | 152 |
| Raceline.....                                 | 153 |
| <b>UTV Red A91 Ryno Beadlock Rings</b>        |     |
| Raceline.....                                 | 153 |

## V

|                                         |         |
|-----------------------------------------|---------|
| <b>Valve Core Remover</b>               |         |
| Motion Pro .....                        | 342     |
| <b>Valve Guide Ball Hone Tool</b>       |         |
| KPMI .....                              | 317     |
| <b>Valve Guide Reamer</b>               |         |
| KPMI .....                              | 317     |
| <b>Valve Shim 5Pk</b>                   |         |
| Hotcams.....                            | 315     |
| <b>Valve Shims</b>                      |         |
| Hotcams.....                            | 316     |
| <b>Valve Stem Seal Install Tool</b>     |         |
| Motion Pro .....                        | 327     |
| <b>Valve Stem Seal Install Tool Kit</b> |         |
| Motion Pro .....                        | 355     |
| <b>Valve Stems</b>                      |         |
| Martin.....                             | 190     |
| <b>Vent Cap</b>                         |         |
| VP .....                                | 427     |
| <b>Vent Hose</b>                        |         |
| Keihin.....                             | 496     |
| <b>Vent Hose Slip</b>                   |         |
| Keihin.....                             | 496     |
| <b>Vent Tube Anchor Plate</b>           |         |
| Mikuni .....                            | 521     |
| <b>Vent Tubing</b>                      |         |
| Keihin.....                             | 496     |
| <b>Versa Cross</b>                      |         |
| ITP .....                               | 121     |
| <b>Versa Cross V3</b>                   |         |
| ITP .....                               | 121     |
| <b>Vertex</b>                           |         |
| Butterfly Carburetor Rebuild Kit.....   | 484     |
| <b>Visor Cleaner</b>                    |         |
| Liqui Moly.....                         | 234     |
| <b>Voltage Peak Reading Adapter</b>     |         |
| RM Stator.....                          | 416     |
| <b>VP</b>                               |         |
| 3 Gallon Motorsport Container.....      | 428     |
| 5.5 Gallon Motorsport Containers...     | 426     |
| Aluminum Jug/Can Holder.....            | 427     |
| Container Cap.....                      | 427     |
| Deluxe Container Hose.....              | 427     |
| Fuel Jugs .....                         | 426-428 |
| Get Bent Hose Bender.....               | 427     |
| Standard Container Hose .....           | 427     |

|                                    |         |
|------------------------------------|---------|
| Trigger Fluid Control System ..... | 427     |
| Vent Cap .....                     | 427     |
| <b>V-Twin Engine Oil</b>           |         |
| Maxima .....                       | 237-245 |
| <b>V-Twin Steering Race Tool</b>   |         |
| Motion Pro .....                   | 363     |
| <b>V-Twin Techniplate Oil</b>      |         |
| Klotz.....                         | 212     |

## W

|                                              |     |
|----------------------------------------------|-----|
| <b>Walbro Type In-Line Fuel Filter</b>       |     |
| SPI .....                                    | 536 |
| <b>Wall Bracket For T-Handle</b>             |     |
| Motion Pro .....                             | 335 |
| <b>Wall Mounted Grease Gun Holder</b>        |     |
| Performance Tool.....                        | 405 |
| <b>Washer</b>                                |     |
| Mikuni .....                                 | 518 |
| <b>Washougal</b>                             |     |
| Kenda .....                                  | 79  |
| <b>Washougal 2</b>                           |     |
| Kenda .....                                  | 79  |
| <b>Waterless Coolant</b>                     |     |
| Evans.....                                   | 201 |
| <b>Waterless Prep Fluid</b>                  |     |
| Evans.....                                   | 201 |
| <b>Waterproof Battery Tender</b>             |     |
| Deltran .....                                | 434 |
| <b>Waterproof Grease</b>                     |     |
| Maxima .....                                 | 241 |
| <b>Waterweld Epoxy Putty</b>                 |     |
| J-B Weld .....                               | 204 |
| <b>Wheel Alignment Tool For M8 Soft Tail</b> |     |
| Motion Pro .....                             | 361 |
| <b>Wheel Bearing Greaser 30mm</b>            |     |
| EPI .....                                    | 310 |
| <b>Wheel Bearing Greaser 39mm</b>            |     |
| EPI .....                                    | 310 |
| <b>Wheel Bearing Greaser 40mm</b>            |     |
| EPI .....                                    | 310 |
| <b>Wheel Bearing Greaser 44mm</b>            |     |
| EPI .....                                    | 310 |

# INDEX

**Wheel Bearing Removal Set For HD (3/4 , 1" & 25mm)**

Motion Pro ..... 324

**Wheel Bearing Remover**

Motion Pro ..... 322

**Wheel Bearing Remover 8 Piece Metric Set**

Motion Pro ..... 322

**Wheel Cleaner**

Pig Spit ..... 275

S100 ..... 281

**Wheel Gel**

Bio-Kleen ..... 198

**White Grease**

Motorex ..... 255

**Wire Brush**

Performance Tool ..... 405

**Wire Crimper/Stripper**

Performance Tool ..... 395

**Woodweld Syringe**

J-B Weld ..... 204

**Woody's**

Hex Insert Stud ..... 429

Sharpening Wheel ..... 429

Square Support Plate Tool ..... 430

Stud Installation Tool ..... 429

Track Clip Tool ..... 429

Track Drill Tool ..... 429

Track Marker ..... 430

Track Tension Tool ..... 429

Track Tools ..... 429-430

**Workzone**

Maxxis ..... 138

**Wrinkle Black Paint**

PJ1 ..... 276

**X**

**XB-455 Tire Bead Breaker**

Beadbuster ..... 301

**XR Bearing Retainer Tool**

Motion Pro ..... 339

**Y**

**Y Connector 3/16"**

Motion Pro ..... 345

**Y Fitting**

SPI ..... 536

**Yamaha Idle Kit**

Motion Pro ..... 336

**Yellow Tubing**

Helix Racing ..... 489

**YTZ Battery**

Yuasa ..... 457

**Yuasa**

6 Volt Batteries ..... 460

Battery Acid ..... 467

Battery Bolt ..... 467

Battery Chargers ..... 466

Battery Cross Reference Chart ..... 461-462

Battery Designation Chart ..... 456

Battery Hardware ..... 467

Battery Maintainer ..... 466

Battery Specification Chart ..... 463-465

Conventional Batteries ..... 459-460

GYZ Battery ..... 457

Jumper Cables ..... 446

Maintenance Free Batteries ..... 456-458

YTZ Battery ..... 457

Yuasa Batteries ..... 456-460

**Yuasa Batteries**

Yuasa ..... 456-460

**Z**

**Zilla**

Maxxis ..... 143

---

**DISTRIBUTED BY**

**AUTOMATIC**  
**DISTRIBUTORS**

We are a top national wholesale distributor. offering an extensive selection of over 350 of the best brands in high-quality parts and accessories for the power sports market.

Copyright © 2025 by Automatic Distributors. All rights reserved.

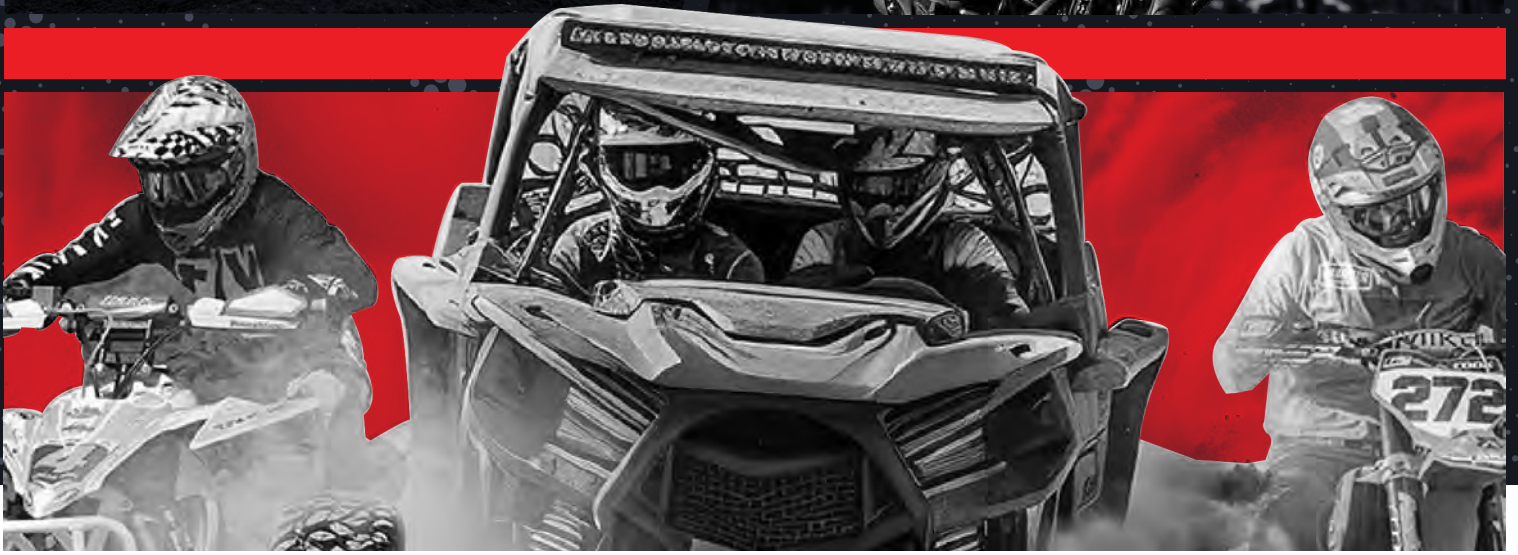

# **AUTOMATIC DISTRIBUTORS**

[www.autodist.com](http://www.autodist.com)

**207-942-6769**