

AUTOMATIC
DISTRIBUTORS



TRAILER

PARTS & ACCESSORIES CATALOG



BUNK WRAP



Caliber Bunk Wraps are the perfect solution for your old worn out carpet covered bunks. They are easy to install, smooth and are the permanent solution for any damaged trailer bunks.



PROUDLY DISTRIBUTED BY

**AUTOMATIC
DISTRIBUTORS**

TIRES & WHEELS	9-20
AXLES, HUBS & SPRINGS	21-40
TONGUE ACCESSORIES	41-52
HITCHES	53-72
ELECTRICAL	73-132
BRAKE PARTS	133-158
TRAILER HARDWARE	159-164
LOCKS & PINS	165-180
TOWING & LOADING	181-204
TIE DOWNS	205-214
TOOLS	215-274
CHEMICALS	275-290

NEW ITEMS **IN TRAILER**



AUTOMATIC
DISTRIBUTORS

NEW ITEMS

TOOLS



Terapumps product line eliminates the lifting of large, heavy, gas cans and spilling wasted fuel. Their exclusive design makes transferring fuel to cars, trucks, off road vehicles, boats, mowers and more, painless and hassle free. We are excited that Terapump is now part of the amazing group of brands brought to you by Automatic Distributors.

FUEL TRANSFER PUMP

- Delivery Volume: 9 liters (2.5 Gallons) per minute.
- Flow Control: Allows for quick starting and stopping.



FUEL TRANSFER PUMP XL

- Flow Rate of up to 2.4 Gallons per minute.
- Auto-Stop System to prevent fuel loss or accidental spills.



Pages 234-235 in Tools

CHEMICAL RESISTANT TRANSFER PUMP

- Flow Rate of up to 2.3 Gallons per minute.
- Water-Resistant Battery Cover for accidental fuel spills.



METERED ELECTRIC PUMP

- 35L: Electric Fuel Meter for precise flow rates.
- Drum Barrel Fit: Applicable on 55 gallon drums & IBC Totes.



TELESCOPIC ELECTRIC PUMP

- Drum Barrel Fit: Applicable on 55 gallon drums & up to 275 Gallon IBC Totes.



LEVER ACTION DRUM PUMP

- Fits: 50 to 205L Drums (15-55 Gallons).
- Telescopic Intake: Adjustable to fit various drum Barrel sizes.



NEW ITEMS

TOOLS



MAGNETIC LIGHT MINE PROFESSIONAL FLASHLIGHT



- 250 lumen Bright white LED
- Rear red night vision/hazard light
- 12 Neodymium magnets to aim light at many angles
- Use as a pick up tool
- 4 mode button switch
- Weather resistant

Page 263 in Tools



FLEXIT 2.0 FLASHLIGHT

- Ultra thin flexible silicone body
- 16 bright Lumen Tech LEDs
- 4 light functions (low, med, high, flash)
- 3 AA batteries included
- 2 rare earth magnets for hands free operation

RISK RACING FLEXIT HEADLAMP

- 250 True Lumens
- Center CREE LED spot light
- Comfort fit foam
- Fully flexible body
- 5 light modes
- Weather resistant



Page 264 in Tools

FLEXIBLE MAGNETIC FLASHLIGHT



- 500 lumens
- Center CREE LED spot light
- Dual charging via solar panel or micro-USB
- Red night reading LEDs
- Fully flexible body
- Non-marring rubber magnetic durable base
- Shape-Loc frame
- 5 light modes
- Weather resistant

UTILITY JUG



- 3 gallon (12 liter) or 5 gallon (20 liter)
- Durable thick-walled HDPE plastic
- 3 ergonomic handle design
- Breather allows venting prevents leaks/spills
- Flat surface in center of jug for custom graphics
- Transport safely and securely with the EZ Floor Mount

HOSE BENDER

- Spout bender for spill free operation
- Stability hook
- High efficiency flow rate
- Threads into most caps



Page 263 in Tools



NEW ITEMS

UTILITY JUG FLOOR MOUNT



- Secure the EZ3 or EZ5 Utility Jug to your truck, trailer or van
- Ability to use a padlock for extra security
- Size: 11" x 6.75" x 3.5" (27.5cm x 14.5cm x 8.9cm)
- Use with EZ3 or EZ5 Utility Jug
- Recommended flathead screw size (not included):
 - 5x Wood or sheet metal flathead screws: #8 - 1" length
 - 5x Flathead bolts: 3/16"

TOOLS



MAGNETIC LIGHT MINE

- Bright wide angle LED
- 12 rare earth magnets for easy hands free operation
- Small to fit in tight spaces (about the size of a golf ball)



Page 263 in Tools

TRILIGHT CEILING LIGHT

The TRiLIGHT motion sensing LED ceiling light replaces the dim light bulb typically found in your garage, basement or utility room. Upgrading to 4000 True Lumens Bright White LED light and motion activation is as easy as screwing in a light bulb! Now with adjustable motion sensitivity!



Page 264 in Tools



MOTION ACTIVATED LIGHTING SYSTEM

The MPI creates five points of light, all from your existing fixture! These 5 points spread light to all corners of the room, filling the entire space and reducing shadows caused by single-point illumination. This system installs in minutes and is powered by a standard ceiling fixture, eliminating the need to hire an electrician to properly light large spaces like a garage, attic, or basement.



TRILIGHT SHOPLIGHT V2

TRILIGHT SHOPLIGHT V2

The TRiLIGHT ShopLight V2 has the ability to quickly transform from a 360 degree drop light, into a single direction shop light, and any light pattern in-between. This adaptability offers a wider variety of more useful light arrays in comparison to traditional lighting.

Page 264 in Tools

NEW ITEMS

TOOLS



MOBILE TASK LIGHT

- 1200 lumens
- Dual focus lens
- Dual Lithium-ion battery technology
- Micro-USB Rechargeable
- 4 light modes (high, medium, low, strobe)
- Battery level indication, via button when The Mobile Task Light is turned off
- Adjustable Aluminum Head
- Steel ExoSkeleton
- Hanging Hooks
- Universal camera tripod mount



TRILIGHT SHOPLIGHT

The TRiLIGHT ShopLight quickly transforms from a 360 degree 3000 True Lumen drop light, into an omni-directional shop light, and any light pattern in-between. This adaptability offers a wider variety of more useful light arrays in comparison to traditional shop lighting.



Page 264 in Tools



G1 SAFETY GLASSES



Premium safety glass, with an upgraded nose bridge and adjustable-length ear pieces.

G2 SAFETY GLASSES



No-frills safety glasses, meant to keep cost low - with all the quality you expect from RZ®.

Page 273 in Tools

TOWING & LOADING



CALIBER BULK BUNK WRAP ROLLS & END CAP HARDWARE



Page 186 in Towing & Loading





AUTOMATIC
DISTRIBUTORS

TRAILER CATALOG

**TIRES
& WHEELS**

TIRES & WHEELS



LOAD STAR TIRE & WHEEL ASSEMBLIES

Computer designed tread features a radial tire appearance with bias tire's durability.
Advanced rubber compound gives longer tread wear and low rolling resistance.
Flatter tread profile allows for increased towing stability.

- tires & wheels
- axles, hubs & springs
- tongue accessories
- hitches
- electrical
- brake parts
- trailer hardware
- locks & pins
- towing & loading
- tie downs
- tools
- chemicals

PART #	MFG #	TIRE SIZE	# HOLES	LOAD RANGE	RIM COLOR	MAXIMUM LOAD CAPACITY LBS @ PSI	
TIRE AND WHEEL ASSEMBLIES							
698102	60.95	30000	480X8	4	B	WHITE	590 @ 60
698142	60.95	30020	480X8	5	B	WHITE	590 @ 60
698204	91.95	30050	480X8	4	C	GALVANIZED	745 @ 90
698245	91.95	30070	480X8	5	C	GALVANIZED	745 @ 90
698104	84.95	30080	570X8	4	B	WHITE	715 @ 50
698144	83.95	30100	570X8	5	B	WHITE	715 @ 50
698208	113.95	30130	570X8	4	C	GALVANIZED	910 @ 75
698248	113.95	30150	570X8	5	C	GALVANIZED	910 @ 75
698126	120.95	30540	480X12	4	B	WHITE	780 @ 60
698166	125.95	30580	480X12	5	B	WHITE	780 @ 60
698174	134.95	30630	480X12	4	C	GALVANIZED	990 @ 90
698175	134.95	30670	480X12	5	C	GALVANIZED	990 @ 90
698130	131.95	30700	530X12	4	B	WHITE	840 @ 55
698170	137.95	30740	530X12	5	B	WHITE	840 @ 55
698172	138.95	30780	530X12	4	C	WHITE	1045 @ 80
698173	149.95	30820	530X12	5	C	WHITE	1045 @ 80
698178	156.95	30790	530X12	4	C	GALVANIZED	1045 @ 80
698179	156.95	30850	530X12	5	C	GALVANIZED	1045 @ 80
PNEUMATIC TIRE							
698190	196.95	3S140	ST175/80DX13	5	C	WHITE	1360 @ 50
698200	202.95	3S160	ST175/80DX13	5	C	GALVANIZED	1360 @ 50
698191	227.95	3S440	ST205/75DX14	5	C	WHITE	1760 @ 50
698192	240.95	3S550	ST215/75DX14	5	C	WHITE	1870 @ 50
698202	267.95	3S560	ST215/75DX14	5	C	GALVANIZED	1870 @ 50
698193	229.95	3S640	ST205/75DX15	5	C	WHITE	1820 @ 50
698201	272.95	3S650	ST205/75DX15	5	C	GALVANIZED	1820 @ 50
RADIAL TIRE							
698091	225.95	S1952	ST175/80RX13	5	C	GALVANIZED	1360 @ 50
698092	298.95	S2156	ST205/75RX14	5	C	GALVANIZED	1760 @ 50
698093	315.95	S2397	ST205/75RX15	5	C	GALVANIZED	1820 @ 50
698196	336.95	S2508	ST225/75RX15	6	C	WHITE	2150 @ 50



TRAILER



TIRES & WHEELS

LOAD STAR TIRE & WHEEL ASSEMBLIES

All purpose tread design, Designed like radial tires.



PART #	MFG #	TIRE SIZE	REPLACES	# HOLES	LOAD RANGE	RIM COLOR	MAXIMUM LOAD CAPACITY LBS @ PSI	
TIRE AND WHEEL ASSEMBLIES								
698260	120.95	3H250	215/60X8	18.5X8.5X8	4	B	WHITE	770 @ 35
698262	120.95	3H270	215/60X8	18.5X8.5X8	5	B	WHITE	770 @ 35
698264	130.95	3H290	215/60X8	18.5X8.5X8	4	C	WHITE	940 @ 50
698266	129.95	3H310	215/60X8	18.5X8.5X8	5	C	WHITE	940 @ 50
698270	158.95	3H260	215/60X8	18.5X8.5X8	4	B	GALVANIZED	770 @ 35
698272	157.95	3H280	215/60X8	18.5X8.5X8	5	B	GALVANIZED	770 @ 35
698274	176.95	3H300	215/60X8	18.5X8.5X8	4	C	GALVANIZED	940 @ 50
698276	168.95	3H320	215/60X8	18.5X8.5X8	5	C	GALVANIZED	940 @ 50
698300	134.95	3H292	215/60X8	18.5X8.5X8	4	C	SILVER	940 @ 50
698302	133.95	3H312	215/60X8	18.5X8.5X8	5	C	SILVER	940 @ 50
698280	147.95	3H330	205/65X10	20.5X8.00X10	4	B	WHITE	905 @ 35
698282	146.95	3H350	205/65X10	20.5X8.00X10	5	B	WHITE	905 @ 35
698284	158.95	3H370	205/65X10	20.5X8.00X10	4	C	WHITE	1105 @ 50
698286	155.95	3H390	205/65X10	20.5X8.00X10	5	C	WHITE	1105 @ 50
698290	203.95	3H340	205/65X10	20.5X8.00X10	4	B	GALVANIZED	905 @ 35
698292	209.95	3H360	205/65X10	20.5X8.00X10	5	B	GALVANIZED	905 @ 35
698294	216.95	3H380	205/65X10	20.5X8.00X10	4	C	GALVANIZED	1105 @ 50
698296	216.95	3H400	205/65X10	20.5X8.00X10	5	C	GALVANIZED	1105 @ 50
698298	237.95	3H440	205/65X10	20.5X8.00X10	5	D	GALVANIZED	1330 @ 50
698310	154.95	3H371	205/65X10	20.5X8.00X10	4	C	SILVER	1105 @ 50
698312	155.95	3H394	205/65X10	20.5X8.00X10	5	C	SILVER	1105 @ 50
698320	174.95	3H432	205/65X10	20.5X8.00X10	5	D	SILVER	1330 @ 50
698324	178.95	3H482	205/65X10	20.5X8.00X10	5	E	SILVER	1535 @ 50



- tires & wheels
- axles, hubs & springs
- tongue accessories
- hitches
- electrical
- brake parts
- trailer hardware
- locks & pins
- towing & loading
- tie downs
- tools
- chemicals



Lug nuts (or bolts) are tightened as shown

Wheel Torque Chart	Stud Size	lbs/ft
	1/2" -20	70-90
Standard Wheels	9/16" -18	110-140
	5/8" -18	125-140

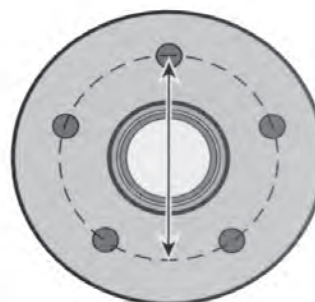

Bolt pattern is measured through center bolt circle

TRAILER

FAST SAME DAY SHIPPING

TIRES & WHEELS

WHEELS

We offer a wide range of sizes and styles for most any trailer application painted wheels have e-coat and powder coated for a long lasting finish.



PART #	MFG #	WHEEL SIZE INCHES	BOLT	BOLT PATTERN INCHES	FITS HOLE INCHES	TIRE SIZE	SOLID / SPOKE	COLOR
WHEELS								
693202	21.95	20001	8X3.75	4	4	2-1/2	480X8/570X8	SOLID WHITE
693252	21.95	20006	8X3.75	5	4.5	2-13/16	480X8/570X8	SOLID WHITE
693282	51.95	20003	8X3.75	4	4	2-1/2	480X8/570X8	SOLID GALVANIZED
693284	50.95	20008	8X3.75	5	4.5	2-13/16	480X8/570X8	SOLID GALVANIZED
693206	27.95	20011	8X5.375	4	4	2-1/2	16-1/2X8	SOLID WHITE
693256	27.95	20016	8X5.375	5	4.5	2-13/16	16-1/2X8	SOLID WHITE
693210	29.95	20021	8X7	4	4	2-1/2	18-1/2X8	SOLID WHITE
693260	29.95	20026	8X7	5	4.5	2-13/16	18-1/2X8	SOLID WHITE
693240	37.95	20019	8X7	4	4	2-1/2	18-1/2X8	SOLID SILVER
693242	30.95	20027	8X7	5	4.5	2-13/16	18-1/2X8	SOLID SILVER
693283	74.95	20023	8X7	4	4	2-1/2	18-1/2X8	SOLID GALVANIZED
693285	70.95	20028	8X7	5	4.5	2-13/16	18-1/2X8	SOLID GALVANIZED
693265	36.95	20038	9X4	5	4.5	2-13/16	690X9	SOLID WHITE
693220	47.95	20041	10X6	4	4	2-1/2	20-1/2X10	SOLID WHITE
693270	47.95	20046	10X6	5	4.5	2-13/16	20-1/2X10	SOLID WHITE
693244	47.95	20042	10X6	4	4	2-1/2	20-1/2X10	SOLID SILVER
693246	47.95	20047	10X6	5	4.5	2-13/16	20-1/2X10	SOLID SILVER
693278	109.95	20043	10X6	4	4	2-1/2	20-1/2X10	SOLID GALVANIZED
693280	102.95	20048	10X6	5	4.5	2-13/16	20-1/2X10	SOLID GALVANIZED
693226	42.95	20102	12X4	4	4	2-1/2	480X12/530X12	SOLID WHITE
693276	62.95	20112	12X4	5	4.5	2-13/16	480X12/530X12	SOLID WHITE
693286	74.95	20124	12X4	4	4	2-13/16	480X12/530X12	SPOKE GALVANIZED
693288	73.95	20124	12X4	5	4.5	2-13/16	480X12/530X12	SPOKE GALVANIZED
693230	56.95	20122	12X4	4	4	2-13/16	480X12/530X12	SPOKE WHITE STRIPE
693232	56.95	20132	12X4	5	4.5	2-13/16	480X12/530X12	SPOKE WHITE STRIPE
693290	95.95	20234	13X4.5	5	4.5	2-13/16	B78X13	SPOKE GALVANIZED
693300	74.95	20232	13X4.5	5	4.5	2-5/8	B78X13	SPOKE WHITE STRIPE
693292	121.95	20354	14X6	5	4.5	2-13/16	F78X14/G78X14	SPOKE GALVANIZED
693301	90.95	20352	14X6	5	4.5	2-5/8	F78X14/G78X14	SPOKE WHITE STRIPE
693294	135.95	20524	15X6	5	4.5	2-13/16	F78X15/H78/15	SPOKE GALVANIZED
693302	95.95	20422	15X5	5	4.5	2-5/8	F78X15/H78/15	SPOKE WHITE STRIPE

TRAILER

- tires & wheels
- axles, hubs & springs
- tongue accessories
- hitches
- electrical
- brake parts
- trailer hardware
- locks & pins
- towing & loading
- tie downs
- tools
- chemicals



LOAD STAR TIRE ONLY

Load star provides a wide range of trailer tires designed to run cooler and longer, reduce rolling resistance and increase durability.

PART #	MFG #	TIRE SIZE	LOAD RANGE	MAX LOAD CAPACITY @ PSI
LOAD STAR TIRE ONLY				
698002	41.95	10002	480X8	B 590 @ 60
698004	64.95	10010	570X8	B 715 @ 50
698006	70.95	10012	570X8	C 910 @ 75
698028	64.95	10060	480X12	B 780 @ 60
698030	79.95	10064	530X12	B 840 @ 55
698090	122.95	1ST76	ST175/80DX13	C 1360 @ 50
698095	151.95	1ST86	ST205/75DX14	C 1760 @ 50
698096	163.95	1ST90	ST215/75DX14	C 1820 @ 50
698097	151.95	1ST92	ST205/75DX15	C 1870 @ 50
698252	109.95	1HP26	215/60X8	C 940 @ 50
698254	125.95	1HP52	205/65X10	C 1105 @ 50
698256	131.95	1HP54	205/65X10	D 1270 @ 50



tires & wheels

axles, hubs & springs

tongue accessories

hitches

electrical

brake parts

trailer hardware

locks & pins

towing & loading

tie downs

tools

chemicals

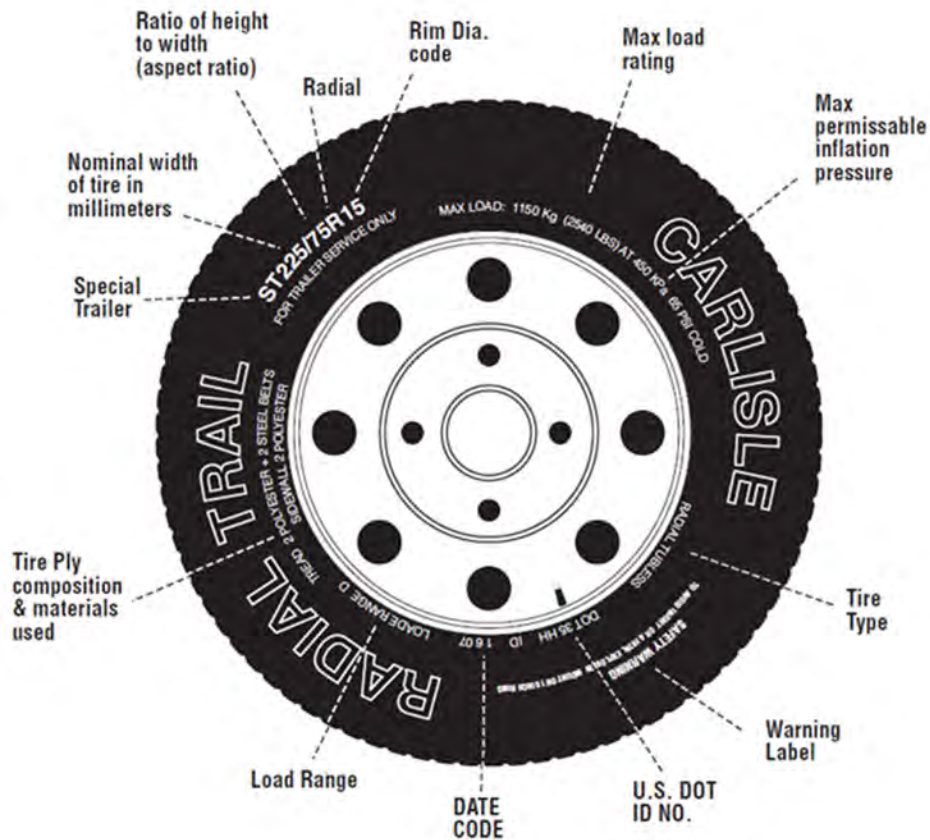

How to Read your Tires

TRAILER

TIRES & WHEELS

LAWN/GARDEN & TRAILER TUBES

tires & wheels

axles, hubs & springs

tongue accessories

hitches

electrical

brake parts

trailer hardware

locks & pins

towing & loading

tie downs

tools

chemicals

TRAILER



TR13



TR87

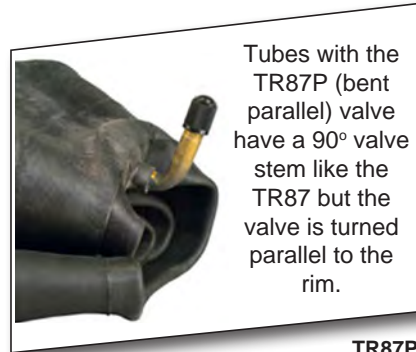

TR87P

Tubes with the TR87P (bent parallel) valve have a 90° valve stem like the TR87 but the valve is turned parallel to the rim.

PART #	MFG #	TUBE SIZE	TUBE VALVE STYLE
Y-0430	10.77	320030	9 X 3.50-4 TR87
Y-0431	10.77	320031	9 X 3.50-4 TR87P
Y-0401	10.35	320050	280 X 2.50-4 TR87
Y-0406	10.75	320010	280 X 2.50-4 TR87P
Y-0411	10.75	320040	410 X 3.50-4 TR13
Y-0402	11.46	320100	410 X 3.50-4 TR87
Y-0403	10.77	320020	410 X 3.50-4 TR87P
Y-0501	10.75	320150	340 X 3.00-5 TR87
Y-0505	11.91	320070	410 X 3.50-5 TR13
Y-0502	11.91	320200	410 X 3.50-5 TR87
Y-0506	11.91	320060	410 X 3.50-5 TR87P
Y-0509	12.67	323980	10 X 4.50-5 TR87
Y-0504	15.49	320080	11 X 4.00-5 TR87
Y-0511	14.33	323520	11 X 6.00-5 TR87
Y-0600	10.00	7143	145 X 70-6 TR13
Y-0615	15.95	11061706	145 X 70-6 TR87
Y-0606	7.50	904	400 X 6 TR13
Y-0601	10.75	320250	410 X 3.50-6 TR87
Y-0609	10.75	320160	410 X 3.50-6 TR13
Y-0604	14.35	320260	13 X 5.00-6 TR87
Y-0611	14.35	323790	13 X 5.00-6 TR13
Y-0607	16.69	320170	13 X 6.50-6 TR13
Y-0670	14.36	320270	530 X 4.50-6 TR87
Y-0602	15.27	320290	15 X 6.00-6 TR87
Y-0605	15.50	323800	15 X 600 - 6 TR13

PART #	MFG #	TUBE SIZE	TUBE VALVE STYLE
Y-0801	12.37	320360	350 X 4.00-8 TR87
Y-0821	10.75	320120	350 X 4.00-8 TR13
Y-0803	11.95	320400	480 X 4.00-8 TR13
Y-0806	12.64	320130	480 X 4.00-8 TR87P
Y-0804	14.46	320450	570 X 5.00-8 TR13
Y-0805	14.91	320420	16 X 6.50/7.50-8 TR13
Y-0807	30.95	11086820	18 X 8.50/9.50 X 8 TR6
Y-0811	21.88	320410	18 X 6.50/8.50/9.50-8 TR13
Y-0809	24.88	320440	22X11.00-8 TR6
Y-0812	33.95	11088430	22 X 11.00-8 TR13
Y-0902	21.94	321500	690 X 6.00-9 TR13
Y-0907	35.95	11098420	22X11.00-9 TR6
Y-0904	38.95	321520	25X12.00-9 TR6
Y-0905	39.95	11099230	25X12.00-9 TR13
Y-1070	27.53	320770	20X8.00/10.00-10 TR13
Y-1018	34.95	11108020	21X7.00-10 TR6
Y-1017	34.95	11108320	22X8.00-10 TR6
Y-1016	38.95	11108420	22X11.00-10 TR6
Y-1101	39.95	11119020	23.5X8.00-11 TR6
Y-1102	37.95	11119120	24X9.00-11 TR6
Y-1202	15.06	320901	530 X 4.50-12 TR13
Y-1210	33.63	321371	22/23 X 8 R11/12 TR6
Y-1207	26.41	321370	23X8.50/9.50/10.50-12 TR13
Y-1212	39.64	321051	24/26 X 12 TR6
Y-1204	39.95	11084520	25X8.00-12 TR6
Y-1205	42.95	11109520	25X10.00-12 TR6
Y-1206	39.95	11129220	25/26 X 12 X 12 TR6
Y-1250	38.05	321050	26 X 12-12 TR13

TUBELESS VALVES

PART #	MFG #	HOLE SIZE	LENGTH
690412	0.80	TR412	RUBBER STEM SNAP IN STRAIGHT 1/2" 1"
690413	0.80	TR412	RUBBER STEM SNAP IN STRAIGHT 1/2" 1-1/4"



FULTON HDPE PLASTIC FENDERS

Fulton plastic fenders are injection molded, Corrosion proof, impact resistant, 300lbs. capacity molded in color "scratch proof" built in fender skirt. Features mounting slots.



- Mounting slots make installation fast and easy!
- Replace your rusted and damaged fender with a Fulton quality engineered plastic fender
- Attractive, sleek styling
- Each fender individually packaged in a poly bag with installation instructions

tires & wheels

axles, hubs & springs

tongue accessories

hitches

electrical

brake parts

trailer hardware

locks & pins

towing & loading

tie downs

tools

chemicals

TRAILER

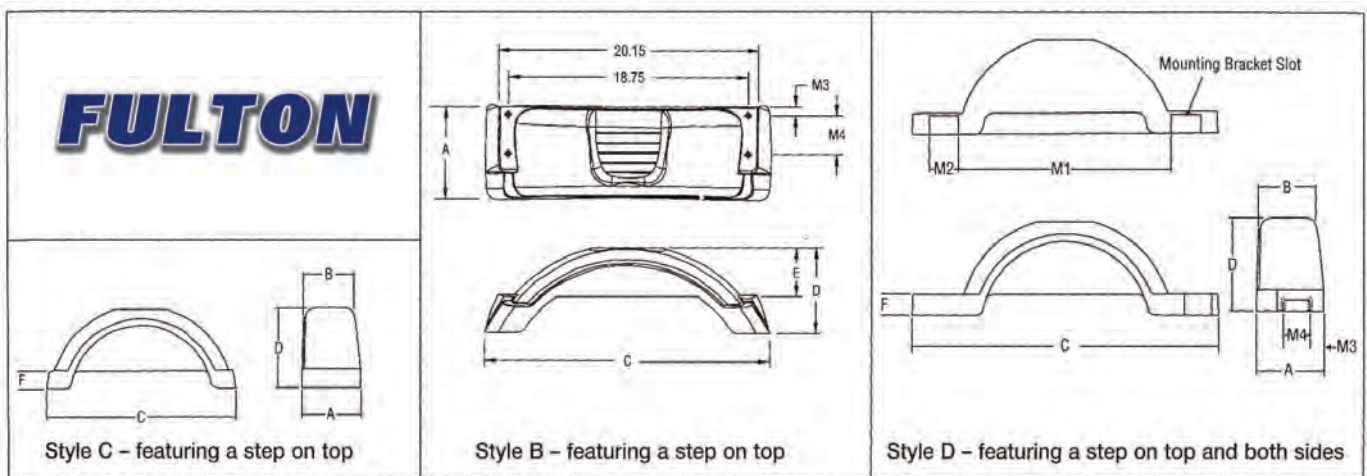

STYLE B

PART # WHITE	PART # BLACK	PART # SILVER	TIRE SIZE	A	B	C	D	E	F	M (1)	M (2)	M (3)	M (4)	UNIT WT LBS.
444357 20.71	444360 19.99	----	8"-12"	7.35"	----	22.30"	6.50"	3.75"	2.18"	----	----	.075"	3.00"	1-1/4"

STYLE C

PART # WHITE	PART # BLACK	PART # SILVER	TIRE SIZE	A	B	C	D	E	F	M (1)	M (2)	M (3)	M (4)	UNIT WT LBS.
----	444362 51.71	----	13"	9.00"	7.70"	29.25"	12.00"	----	2.75"	----	----	----	----	3

STYLE D

PART # WHITE	PART # BLACK	PART # SILVER	TIRE SIZE	A	B	C	D	E	F	M (1)	M (2)	M (3)	M (4)	UNIT WT LBS.
----	444367 32.94	444368 34.72	12"	7.50"	6.90"	33.50"	8.75"	----	2.50"	22.70"	4.00"	1.50"	3.00"	2-1/2
----	444369 42.81	444370 45.91	13"	9.00"	7.70"	40.00"	12.00"	----	2.75"	28.00"	4.00"	2.12"	3.75"	3-3/4
----	444371 48.84	444372 65.95	14"	9.70"	8.00"	43.40"	12.75"	----	3.00"	30.00"	4.00"	2.12"	3.75"	4-3/4

TIRES & WHEELS

tires & wheels

TIE DOWN ENGINEERING PLASTIC FENDERS

Upgrade your trailer with these high impact polyethylene fenders. Plastic fenders are UV protected. Designed for normal and low profile tire. Small fenders have "no load" capacity and fits 8" to 12" wheels. Large fenders have a 200 lbs. capacity and fit 13"-15" wheels.



LR17026
LR17033



276001
276002

PART #	MFG #	DESCRIPTION	DIMENSIONAL SIZE	TIRE SIZE	COLOR	PROFILE	UM	
LR17026	17.59	17026	PLASTIC FENDER	7-3/4"W X 21"L X 5"H	8" - 12"	WHITE	LOW	EA
LR17033	17.71	17033	PLASTIC FENDER	7-3/4"W X 21"L X 5"H	8" - 12"	BLACK	LOW	EA
276001	57.62	44332	PLASTIC FENDER	11-3/8"W x 45"L x 11"H	14"	WHITE	STEP	EA
276002	57.62	44331	PLASTIC FENDER	11-3/8"W x 45"L x 11"H	14"	BLACK	STEP	EA

TIE DOWN ENGINEERING BRACKETS

Fender brackets come packaged as a pair 2 required for each fender.

PART #	MFG #	DESCRIPTION	WHEEL SIZE	COLOR	PROFILE	UM	
LR81231	20.84	81231	BRACKET FOR 8"-12"	8" to 12"	GALVANIZED	LOW	PR
276000	14.35	44141	BRACKET FOR LARGE FENDERS	LARGE	GALVANIZED	STEP	EA



SMITH METAL FENDERS

Heavy-duty 16 gauge steel.

- Fenders can be drilled to fit a variety of mounting options
- Fenders are paintable
- Mounting brackets not included



FND08



ROUND 16 GAUGE GALVANIZED STEEL FENDER

PART #	MFG #	DESCRIPTION	DIMENSIONAL SIZE	TIRE SIZE	COLOR	UM	
FND08	31.04	17700G	METAL FENDER	7"W X 20"L X 6"H	8"	GALVANIZED	EA
FND12	32.38	17701G	METAL FENDER	7"W X 23-1/2"L X 6-3/4"H	12"	GALVANIZED	EA
FND13	44.58	17800G	METAL FENDER	8"W X 27-3/4"L X 11"H	13"	GALVANIZED	EA
FND14	56.75	17900G	METAL FENDER	9"W X 31-1/2"L X 13-1/4"H	14"-15"	GALVANIZED	EA

SMITH FENDER BRACKETS

- Galvanized brackets built for smith metal fenders
- Use two brackets per a fender. (No hardware included).



CS26061



CS26098

PART #	MFG #	DESCRIPTION	WHEEL SIZE	COLOR	PROFILE	UM	
CS26061	27.94	26061GA	BRACKET FOR 7" WIDE FENDER	8" - 12"	GALVANIZED	L SHAPE	EA
CS26098	34.64	26098GA	BRACKET FOR 8"-9" WIDE FENDER	13" - 15"	GALVANIZED	L SHAPE	EA

TRAILER

axles, hubs & springs
tongue accessories
hitches
electrical
brake parts
trailer hardware
locks & pins
towing & loading
tie downs
tools
chemicals

FULTON HIGH MOUNT SPARE TIRE CARRIER

Fits most 4, 5 and 6 lug wheels up to 16-1/2". Provides 4-3/4" lift and over 7" of offset to mount tire up and out of the way zinc-plated to resist corrosion. Easy bolt on no cutting or drilling. Fits trailer tongue up to 3" wide and 5" high. All hardware included.

PART #	MFG #	DESCRIPTION	UM
928052	91.60	HDSTC0101 SPARE TIRE CARRIER	EA

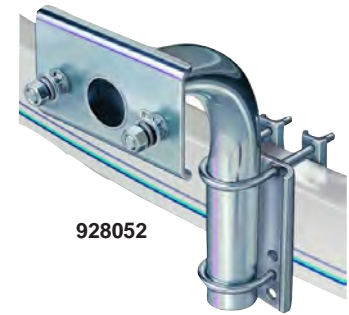

928052

FULTON HIGH MOUNT SPARE TIRE CARRIER

Heavy duty, welded and reinforced steel plate construction zinc-plated to resist corrosion. Adjustable bolt circle to fit 4 and 5 lug wheels. Fits all trailer tongues 3" wide and 4" high includes zinc-plated hardware. Features a security locking hole to lock wheel in place.

PART #	MFG #	DESCRIPTION	UM
FT122	63.95	STC1000101 HI-MOUNT SPARE TIRE CARRIER	EA

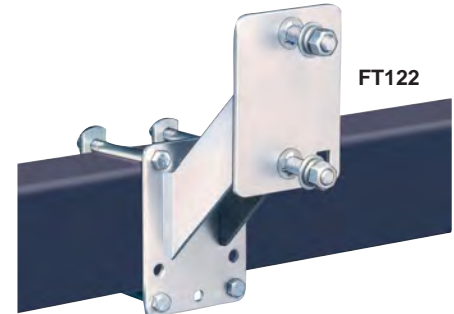

FT122

FULTON SPARE TIRE CARRIER

Fits 8" - 15" wheels with 4 or 5 lug rims. Includes lug nuts to secure wheel to frame. Heavy-duty 1/2" diameter construction. Zinc-plated to resist rust

PART #	MFG #	DESCRIPTION	UM
FT120	18.45	ETC0101 ECONOMY SPARE TIRE CARRIER	EA
FT119	46.76	ETCHL0700 ECONOMY SPARE TIRE CARRIER W/LOCKING LEVERS	EA

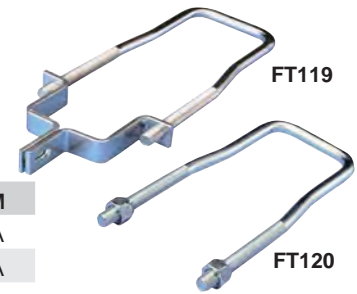

FT119

FT120

SMITH HEAVY DUTY SPARE TIRE CARRIER

Strong 7 gauge steel construction. Hooks securely on frame or tongue. Holds 4 or 5 lug wheels and adjusts for frames 3" wide and 4" highside offset is 4-1/2" from frame with a 5" rise. For more ground clearance. All mounting hardware is included.

PART #	MFG #	DESCRIPTION	UM
CS27310	69.21	27310G HEAVY-DUTY SPARE TIRE CARRIER	EA



CS27310

SMITH HEAVY DUTY SPARE TIRE CARRIER

Heavy 7/16" u-bolt secures tire on tongue or frame up to 3" wide holds 4 or five lug will fit 8"-14" and most 15" wheels adjustable threaded brackets will hold padlock for security. Thread length 3" u-bolt is 8-3/8" long zinc plated

PART #	MFG #	DESCRIPTION	UM
CS27200	15.97	27200 WITH LUG NUTS	EA
CS27201	21.30	27201 WITH LOCKING BRACKETS	EA
CS27202	36.01	27202 WITH BRACKETS AND KEYED PADLOCK	EA



CS27201

CS27202

CS27200

tires & wheels

axles, hubs & springs

tongue accessories

hitches

electrical

brake parts

trailer hardware

locks & pins

towing & loading

tie downs

tools

chemicals

TRAILER

TIRES & WHEELS

tires & wheels

SPARE TIRE COVERS

- Weather and UV Protection
- Strong black vinyl with corded edge and elastic closure for snug fit
- Protects tires from sun and foul weather
- Display packaged



axles, hubs & springs

tongue accessories

hitches

electrical

brake parts

trailer hardware

locks & pins

towing & loading

tie downs

tools

chemicals

PART #	MFG #	TIRE SIZE	DIAMETER	DEPTH	UM
CS27410	26.67	27410	12"	21"	6-1/2" EA
CS27420	33.66	27420	13"	25"	7-1/2" EA
CS27430	35.11	27430	14"	27"	8-1/2" EA
CS27440	36.51	27440	15"	29"	9-1/2" EA



TX0175



TX0100

ULTRA-MAX WHEEL LOCKS

TX0100	363.99	TWL100	TRIMAX ULTRA-MAX WHEEL LOCK	EA
TX0175	138.99	TCL75	TRIMAX WHEEL CHOCK LOCK	EA

WHEEL CHOCKS



BY2556

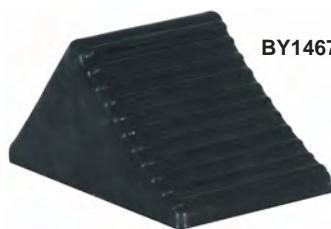

BY1467

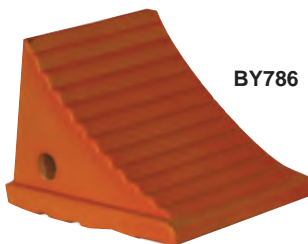

BY786



444355

BY2556	69.26	WC2556A	HEAVY DUTY RUBBER WHEEL CHOCK	EA
BY786	42.26	WC786	POLYURETHANE WHEEL CHOCK	EA
BY1467	24.50	WC1467A	RUBBER WHEEL CHOCK	EA
444355	18.66	7000100	TIRE CHOCKS	SET



SOLO HITCH ALIGNMENT SYSTEM

- Convenient one person hitch alignment system
- Magnetic base for fast and easy location
- Telescoping rods adjust up to 42"
- Easy to use the first time

PART #	MFG #	DESCRIPTION	UM
444356	49.18	63300 SOLO HITCH ALIGNMENT SYSTEM	EA

TRAILER

MINI DIAL TIRE PRESSURE GAUGE

- 1 to 60 PSI range
- Measures 1 one pound increments
- 1" easy to read white face dial
- Proper tire maintenance saves money by improving fuel economy and reducing tire wear
- Ideal for cars, trucks, SUV's, bicycles and more



260069 6.95

DIGITAL TIRE PRESSURE GAUGE

- Backlit display and convenient lighted tip.
- Triple function display P.S.I., BAR, and KPa.
- Auto off feature: Automatically shuts off in 30 seconds when not in use



260070 15.95

12V COMPACT TIRE INFLATOR

- Plugs into 12-Volt Accessory Outlet
- Includes Two Nozzle Adapters and Sport Needle
- Great for Tires, Toys and Sporting Goods
- 10 Ft. Power Cord
- 18 in. Hose Length with Universal Valve Adapter
- Handy on/off switch
- Easy to read pressure gauge
- High output 250 PSI motor



260006 26.95

MINI TIRE INFLATOR

- 100 PSI high pressure air compressor inflates standard car tire in under 8 minutes.
- Compact size for easy storage with convenient storage compartment.
- 9' power cord with fused 12V power plug.
- 12V power cord plugs into vehicle power outlet.
- Built in dial pressure gauge.
- Accessories include sports ball needle, raft and toy inflator nozzles and Presta valve adapter.
- 17.5" high pressure hose.



260007 28.95

TIRE INFLATOR W/LED

- 100 PSI high pressure air compressor.
- Large easy to read built in dial pressure gauge.
- 3 Super bright LEDs for night time emergencies.
- 15" high pressure hose with screw on chuck.
- 10' power cord with fused 12V power plug.
- 12V power cord plugs into vehicle power outlet.
- Inflates standard car tire in under 4 minutes (Performance based upon 175/70 R13 tire to 30 PSI).
- Accessories include sports ball needle, raft and toy inflator nozzles and Presta valve adapter.



260008 43.95

4 WAY FOLDING LUG WRENCH

- SAE heavy duty drop forged steel
- Chrome plated to resist corrosion
- SAE and metric sizes: 11/16", 3/4", 13/16" and 7/8", 17mm, 19mm, 21mm and 23mm
- Folds down for compact storage



260089 30.95

tires & wheels

axles, hubs & springs

tongue accessories

hitches

electrical

brake parts

trailer hardware

locks & pins

towing & loading

tie downs

tools

chemicals

TRAILER

TIRES & WHEELS

tires & wheels

axles, hubs & springs

tongue accessories

hitches

electrical

brake parts

trailer hardware

locks & pins

towing & loading

tie downs

tools

chemicals

TRAILER

35 PC TIRE HARDWARE KIT



- 4pcs chrome hex valve caps
- 4pcs high temp valve cores
- 4pcs plastic valve stems
- 1pc 4 way valve tool
- 1pc tire pressure gauge
- 1pc rubber cement tube
- 1pc metal scuffer
- 10pcs round patches
- 3pcs tubeless tire repair plugs
- 1pc reamer
- 1pc plugger

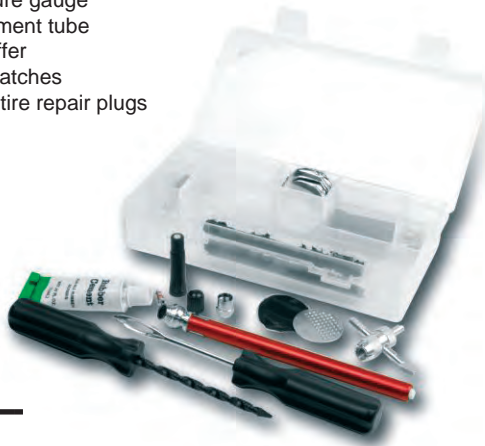

260001 15.95

TIRE REPAIR & MAINTENANCE KIT



- 8 pcs chrome hex valve caps
- 8 pcs high temp valve cores
- 2 pcs each long rubber tire valves and short rubber tire valves
- 8 pcs each plastic valve caps and plastic valve extensions.
- 1 pc each valve core remover, tire chuck and dual foot tire pressure gauge
- 20 pcs tubeless tire repair plugs
- 1 pc each ergonomic grip reamer and ergonomic grip plugger
- For patching, 1 tube rubber cement, 1pc metal scuffer, 2pcs rectangular patches, 2 pcs large round patches and 15pcs small round patches



260000 39.95

STANDARD STEEL TIRE IRONS

- Cold forged steel
- 8 1/2 in. tire iron fit in tool bag or tool pack
- Easy to use
- Set includes a vinyl storage pouch



8-1/2 in. - single	142015	4.99
11 in. - single	678005	6.75
11 in. - pair	678006	12.99
8-1/2 in. - card of 10	142016	47.99

T6™ COMBO LEVER SETS

- Tire spoon with axle nut hex wrench and tire spoon hex wrench for rim lock nut
- All sets include a unique stepped 12mm/13mm hex box end for use with rim locks
- Made from lightweight forged 7075 T-6 aluminum
- Hard anodized finish
- Under 10 inches in length and weigh only 3.5 oz
- Hex ends for axle nuts are rated for a maximum torque of 90 ft-lbs.



22 mm Set	144158	62.99
24 mm Set	144159	62.99
27 mm Set	144160	64.99
32 mm Set	144161	64.99

5 PACK TUBELESS TIRE REPAIR PLUGS

4" long tire repair plugs



260004 3.95



30 PACK TUBELESS TIRE REPAIR PLUGS

4" long tire repair plugs



260003 6.95





AUTOMATIC
DISTRIBUTORS

TRAILER CATALOG

**AXLES, HUBS
& SPRINGS**

AXLES, HUBS & SPRINGS



RELIABLE TRAILER AXLES

All axles come with axle nut and cotter pin attached and include spring seats (loose) that can be mounted over or under.

NOTE: ALL AXLES MUST BE INSTALLED WITH CENTER BOW UP. THE CENTER BOW EXISTS UNTIL WEIGHT IS PUT ON THE AXLE.

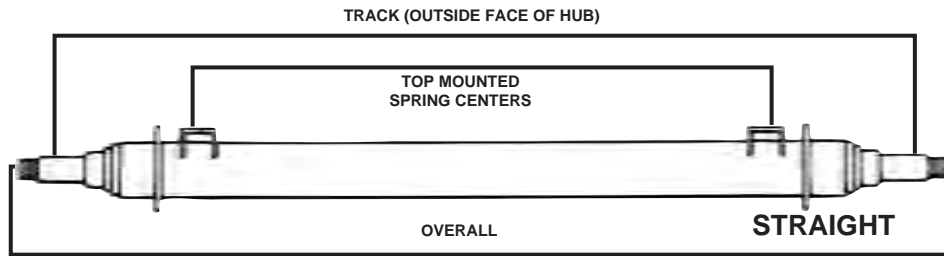

2000# ROUND TUBE AXLES UNFLANGED "L" SERIES

PART #	MFG #	PRICE	TRACK WIDTH	SPRING CENTER FLANGE	OVERALL LENGTH	AXLE SIZE	HUB USED	SPINDLE SIZE	BRAKE SIZE ELECTRIC/ HYDRAULIC
230052	SP-2000-48"	137.89	48"	30" - 38-1/2"	52-1/2"	1-3/4"	230060, 230061	1-1/16" straight	7" X 1-1/4" ELECTRIC 7" X 1-3/4" HYDRAULIC
230053	SP-2000-54"	179.13	54"	36" - 44-1/2"	58"	1-3/4"	230060, 230061	1-1/16" straight	7" X 1-1/4" ELECTRIC 7" X 1-3/4" HYDRAULIC
230054	SP-2000-012	153.24	60"	42" - 50-1/2"	64-1/2"	1-3/4"	230060, 230061	1-1/16" straight	7" X 1-1/4" ELECTRIC 7" X 1-3/4" HYDRAULIC
230055	SP-2000-64"	148.08	64"	46" - 54-1/2"	68-1/2"	1-3/4"	230060, 230061	1-1/16" straight	7" X 1-1/4" ELECTRIC 7" X 1-3/4" HYDRAULIC
230056	SP-2000-72"	170.32	72"	54" - 62-1/2"	76-1/2"	1-3/4"	230060, 230061	1-1/16" straight	7" X 1-1/4" ELECTRIC 7" X 1-3/4" HYDRAULIC
230057	SP-2000-84"	184.48	84"	66" - 74-1/2"	88-1/2"	1-3/4"	230060, 230061	1-1/16" straight	7" X 1-1/4" ELECTRIC 7" X 1-3/4" HYDRAULIC

3500# ROUND TUBE AXLES BRAKE FLANGED "H" SERIES

PART #	MFG #	PRICE	TRACK WIDTH	SPRING CENTER FLANGE	OVERALL LENGTH	AXLE SIZE	HUB USED	SPINDLE SIZE	BRAKE SIZE ELECTRIC/ HYDRAULIC
RL3560	SP-3500-60"	126.60	60"	42" - 48"	65"	2-3/8"	HSH545	1-3/8" - 1-1/16" stepped	10" X 2-1/4" ELECTRIC 10" X 2-1/4" HYDRAULIC

SPRING SEAT

PART #	MFG #	PRICE	AXLE WIDTH	SPRING WIDTH
690996	SS100	4.50	1-3/4"	1-3/4"

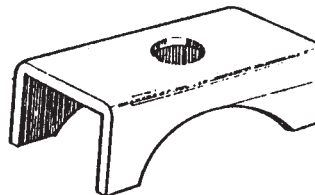

SPINDLE WASHERS

PART #	MFG #	PRICE	STYLE	SIZE	U/M
SWP34	SW-750	4.34	A	3/4"	EA
SWP1	11070	0.95	A	1"	EA

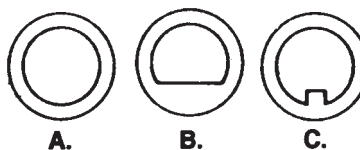

TRAILER

SPINDLE NUTS

PART #	MFG #	STYLE	SIZE	U/M
ANT1	11065	2.61 7.95 SLOTTED	1"	EA



SPINDLE COTTER PIN

PART #	MFG #	A	B	U/M
CP2	11075Z	0.95 2"	1/8"	EA
CP103	SCP103	0.30 1-15/16"	3/8"	EA

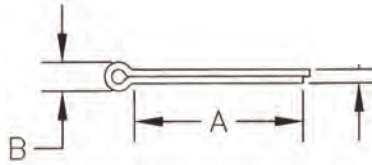

SPINDLE NUT LOCK SHIELD

PART #	MFG #	A	B	U/M
75-813	LS813	8.06 .845"	1.140"	EA

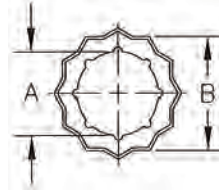

SPINDLE NUT KITS

PART #	MFG #	NUT	WASHER	COTTER PIN	U/M
230010	230010	6.95 ANT1	SWP1	CP2	EA
230011	230011	2.70 ANT1	SWP3	CP2	EA

RELIABLE COMPLETE HUB KITS

- **Hub assemblies** include nuts, bolts, 2 bearings, 2 cups, 1 grease seal, and 1 dust cap
- **Hubs only** are sold with only the cups installed



4 HOLE HUBS

PART #	BEARING SIZE	INNER	BEARING SIZE	OUTER	HUB LENGTH	DISTANCE BET. RACES	HUB CAPACITY	HUB ONLY
HSH4	58.95 1"	LM44643	1"	LM44643	4-1/8"	2-7/16"	1000#	230017 38.95
HSH46	58.95 1-1/16"	LM44649	1-1/16"	LM44649	4-1/8"	2-7/16"	1150#	230017 38.95
230060	32.95 1-1/16"	LM44649	1-1/16"	LM44649	4-1/8"	2-7/16"	-----	230017 38.95

5 HOLE HUBS

PART #	BEARING SIZE	INNER	BEARING SIZE	OUTER	HUB LENGTH	DISTANCE BET. RACES	HUB CAPACITY	HUB ONLY
HSH5	58.95 1"	LM44643	1"	LM44643	4-1/8"	2-7/16"	1000#	230018 39.95
HSH525	58.95 1"	LM44643	1"	LM44643	3-1/2"	1-11/16"	700#	230020 44.31
HSH56	58.95 1-1/16"	LM44649	1-1/16"	LM44649	4-1/8"	2-7/16"	1150#	230018 39.95
HSH545	69.95 1-3/8"	LM68149	1-1/16"	LM44649	4-1/4"	2-1/8"	1750#	230019 46.95
HSH812	159.95 1-1/4"	LM67048	1-1/4"	LM67048	4-3/16"	2-3/16"	1250#	-----
230061	39.95 1-1/16"	LM44649	1-1/16"	LM44649	4-1/8"	2-7/16"	-----	230018 39.95

- tires & wheels
- axles, hubs & springs
- tongue accessories
- hitches
- electrical
- brake parts
- trailer hardware
- locks & pins
- towing & loading
- tie downs
- tools
- chemicals

AXLES, HUBS & SPRINGS

- tires & wheels
- axles, hubs & springs
- tongue accessories
- hitches
- electrical
- brake parts
- trailer hardware
- locks & pins
- towing & loading
- tie downs
- tools
- chemicals

SHIPSHAPE COMPLETE HUB KITS



- Includes: hub, bearings, seal, lug nuts, dust cap, grease
- Painted, cast iron replacement hubs for all types of trailers
- All hubs are studded (as shown)

4 HOLE HUBS

PART #	MFG #		BEARING SIZE	INNER	BEARING SIZE	OUTER	HUB LENGTH	DISTANCE BET. RACES	HUB CAPACITY	HUB
CS13110	13100	77.37	1"	L44643	1"	L44643	4-1/8"	2-7/16"	1250#	-
CS13109	13109	85.42	1-1/16"	L44649	1-1/16"	L44649	4-1/8"	2-7/16"	1350#	-

5 HOLE HUBS

PART #	MFG #		BEARING SIZE	INNER	BEARING SIZE	OUTER	HUB LENGTH	DISTANCE BET. RACES	HUB CAPACITY	HUB
CS13210	13210	88.11	1"	L44643	1"	L44643	4-1/8"	2-7/16"	1250#	-

REPLACEMENT OIL CAP & SEAL ONLY

PART #	MFG #	
LR48394A	48399A	11.93

WHEEL BOLTS



PART #	MFG #		A LENGTH	B LENGTH	C DIAMETER	THREAD	STYLE	U/M
75-5024	2.60	ST-502-04	1.813"	.438"	.543"	1/2"-20	PRESS IN	EA
75-500	1.65	ST-500	2"	1.063"	.688"	1/2"-20	SCREW IN	EA
WBP5	1.95	WBP-5	1-3/4"	1/4"	1/2"	1/2"-20	PRESS IN	EA
WBP3	1.00	WBP-3	7/8"	1/4"		3/8"-24	PRESS IN	EA

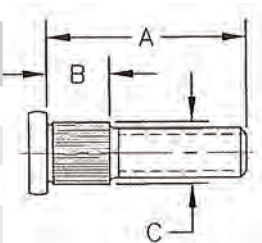

TRAILER



230012



230013



WHEEL BOLTS, NUTS, AND KITS

PART #	MFG #		THREAD	DESCRIPTION	U/M
WBT12	1.65	11060	1/2"-20	WHEEL BOLT	EA
LNT12	0.95	11051	1/2"-20	LUG NUT	EA
LNT76	0.50	LN76	7/16"-20	LUG NUT	EA
230012	5.25	230012	1/2"-20	WHEEL BOLT	PKG 5
230013	1.95	230013	1/2"-20	LUG NUT	PKG 5
230014	3.25	230014	7/16"-20	LUG NUT	PKG 5



TIE DOWN ENGINEERING SPINDLES

- Spindle is turned from high-tensile, cold-rolled steel on automotive-quality CNC lathes
- Spindle must be properly welded to axle tube
- 1" spindle end
- Includes castle nut, washer and cotter pin
- Sold individually



PART #	MFG #	CAPACITY	END SIZE	LENGTH	STUB LENGTH	HUB LENGTH	INNER BEARING	SIZE	OUTER BEARING	SIZE	STUB STYLE	
LR80055	80055	31.95	1250#	1-1/4"	8-1/2"	2-5/8"	3-7/16"	LM44643	1"	LM44643	1"	ROUND
LR80060	80060	31.95	1350#	1-1/4"	7"	2"	3-7/16"	LM44649	1-1/16"	LM44649	1-1/16"	ROUND
LR80235	80235	40.95	1750#	1-3/4"	8"	2-9/16"	3-1/4"	LM68149	1-3/8"	LM44649	1-1/16"	ROUND

RELIABLE SPINDLES



- Cotter pin, washer, and castle nut sold separately
- Sold each (bulk)

PART #	MFG #	CAPACITY
RL1250	S-1250	22.66
RL1350	S-1350	25.39

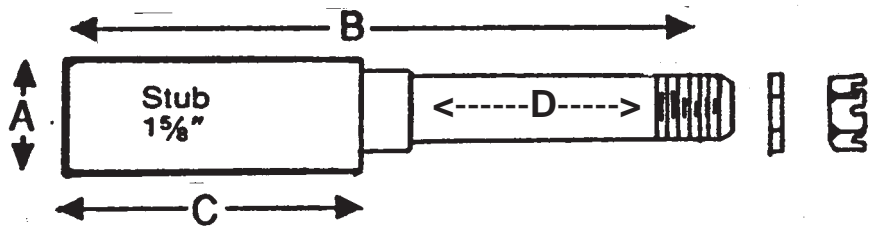

CAPACITY PER PAIR	END SIZE	LENGTH	STUB LENGTH	HUB LENGTH	INNER BEARING	SIZE	OUTER BEARING	SIZE	STUB STYLE	COTTER PIN	WASHER	CASTLE NUT
2500#	1-1/4"	8-1/2"	3-1/8"	3-3/8"	LM44643	1"	LM44643	1"	ROUND	CP2	SWP1	ANT1
2700#	1-1/4"	8-1/2"	3-1/8"	3-3/8"	LM44649	1-1/16"	LM44649	1-1/16"	ROUND	CP2	SWP1	ANT1

Sold in display packages with castle nut, washer, and cotter pin included.

PART #	MFG #	CAPACITY PER PAIR	END SIZE	LENGTH	STUB LENGTH	HUB LENGTH	INNER BEARING	SIZE	OUTER BEARING	SIZE	STUB STYLE	
RL2000	2000	27.95	2500#	1-1/4"	8-1/2"	3-3/4"	3-3/8"	LM44643	1"	LM44643	1"	ROUND
RL2001	2001	27.95	2700#	1-1/4"	8-1/2"	3-3/4"	3-3/8"	LM44649	1-1/16"	LM44649	1-1/16"	ROUND

- tires & wheels
- axles, hubs & springs
- tongue accessories
- hitches
- electrical
- brake parts
- trailer hardware
- locks & pins
- towing & loading
- tie downs
- tools
- chemicals

AXLES, HUBS & SPRINGS

LEAF SPRINGS

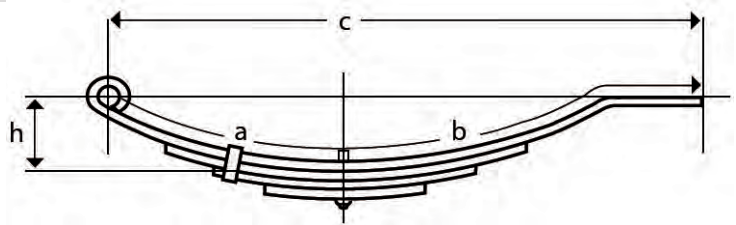

SLIPPER STYLE - FLAT END

PART #	MFG #	PER SPRING CAPACITY	# OF LEAVES	UNLOADED LENGTH	CENTER EYE TO SPRING BOLT (A)	SPRING BOLT TO SPRING END (B)	FREE OPEN (H)	SPRING WIDTH	BUSHING INCLUDED?	
25" LONG										
SLS0925	42.95	UNA203	900#	3	25"	12.10"	14.50"	3.50"	1-3/4"	YES
SLS1225	82.95	UNA207	2300#	5	25"	12.10"	14.50"	3.50"	1-3/4"	YES
30" LONG										
SLS0830	57.95	UNA-038*(F)	880#	2	30"	15"	17.75"	4.88"	1-3/4"	USE LSB2
SLS1430	68.95	UNA-039*(F)	1430#	3	30"	15"	17.75"	4.88"	1-3/4"	USE LSB2
SLS1830	89.95	UNA-040*(F)	1830#	4	30"	15"	17.75"	4.88"	1-3/4"	USE LSB2
SLS2330	163.95	UNA-040N (F)	2290#	5	30"	15"	17.75"	4.88"	1-3/4"	USE LSB2

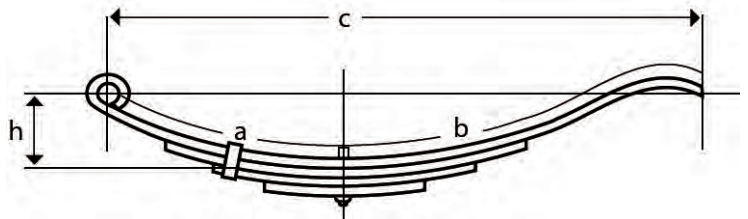

SLIPPER STYLE - RADIUS END

PART #	MFG #	PER SPRING CAPACITY	# OF LEAVES	UNLOADED LENGTH	CENTER EYE TO SPRING BOLT (A)	SPRING BOLT TO SPRING END (B)	FREE OPEN (H)	SPRING WIDTH	BUSHING INCLUDED?	
25" LONG										
SLS7025	34.95	UNA-178 (R)	750#	3	25"	12"	14.50"	4"	1-3/4"	YES
SLS9025	45.95	UNA-179 (R)	900#	4	25"	12"	14.50"	4"	1-3/4"	YES
SLS1125	57.95	UNA-180 (R)	1240#	5	25"	12"	14.50"	4"	1-3/4"	YES
SLS1027	58.95	UNA-132	1000#	2	27.50"	13.62"	16.50"	4.63"	1-3/4"	YES

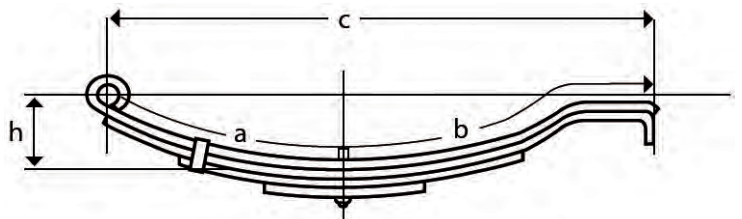

SLIPPER STYLE - HOOK DOWN

PART #	MFG #	PER SPRING CAPACITY	# OF LEAVES	UNLOADED LENGTH	CENTER EYE TO SPRING BOLT (A)	SPRING BOLT TO SPRING END (B)	FREE OPEN (H)	SPRING WIDTH	BUSHING INCLUDED?	
25" LONG										
SLS2530	95.95	UNA-231 (HD)	2500#	4	26.48"	11.96"	15.90"	3.06"	2"	YES
30" LONG										
SLS0730	58.95	UNA-195 (HD)	750#	3	30"	14.60"	18.75"	4.13"	1-3/4"	YES
SLS1030	68.95	UNA-196 (HD)	1000#	4	30"	14.75"	18.90"	4.31"	1-3/4"	YES
SLS1530	80.95	UNA-197	1250#	5	30"	14.75"	18.50"	4.31"	1-3/4"	YES

TRAILER

- tires & wheels
- axles, hubs & springs
- tongue accessories
- hitches
- electrical
- brake parts
- trailer hardware
- locks & pins
- towing & loading
- tie downs
- tools
- chemicals

LEAF SPRINGS CONTINUED

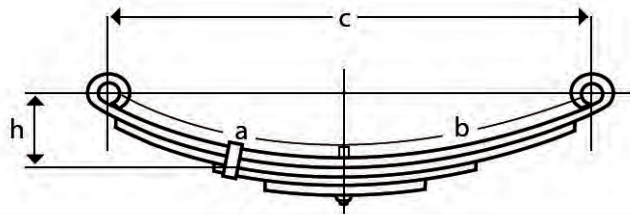

DOUBLE EYE SPRING

PART #	MFG #	PER SPRING CAPACITY	# OF LEAVES	UNLOADED LENGTH	CENTER EYE TO SPRING BOLT (A)	SPRING BOLT TO SPRING END (B)	FREE OPEN (H)	SPRING WIDTH	BUSHING INCLUDED?	
20" LONG										
DES7020	31.95	UNA-168	700#	3	20.31"	11"	11"	3.38"	1-3/4"	YES
DES1020	32.95	UNA-169	1000#	3	20.38"	11"	11"	3.19"	1-3/4"	YES
25" LONG										
DES1225	42.95	UNA-219	1250#	3	25.13"	13.29"	13.29"	3.18"	1-3/4"	YES
DES1525	54.95	UNA-212	1830#	4	25.13"	13.19"	13.19"	3.25"	1-3/4"	YES
DES2025	51.95	UNA-220	2000#	3	25.25"	13.25"	13.25"	3"	1-3/4"	YES
DES3025	64.95	UNA-221	3000#	4	25.13"	13.29"	13.29"	3.29"	1-3/4"	YES
26" LONG										
DES1026	52.95	UNA-124	1000#	4	26"	14.07"	14.07"	4	1-3/4"	YES
DES2526	86.95	UNA-052	2500#	5	26"	14"	14"	4.25"	1-3/4"	YES
27" LONG										
DES1027	77.95	UNA-141	1000#	3	27"	13.98"	13.98"	2.83"	1-3/4"	YES
DES1727	76.95	UNA-210	1750#	4	27"	13.98"	13.98"	2.75"	1-3/4"	YES
DES3027	123.95	UNA142	3000#	6	27"	14.14"	14.14"	3.25"	1-3/4"	YES
29.70" LONG										
DES0630	70.95	UNA-035	650#	3	29.70"	15.63"	15.63"	4"	1-3/4"	USE LSB2
DES1130	88.95	UNA-036	1250#	5	29.70"	15.63"	15.63"	4"	1-3/4"	USE LSB2
DES1530	110.95	UNA-032	1500#	7	29.70"	15.63"	15.63"	4"	1-3/4"	USE LSB2
29.75" LONG										
DES1230	72.95	UNA-224	1250#	3	29.75"	15.87"	15.87"	4.38"	1-3/4"	YES

- tires & wheels
- axles, hubs & springs
- tongue accessories
- hitches
- electrical
- brake parts
- trailer hardware
- locks & pins
- towing & loading
- tie downs
- tools
- chemicals

PLASTIC SPRING BUSHINGS

PART #	MFG #	OUTSIDE DIAMETER	INSIDE DIAMETER	LENGTH	STYLE	U/M
LSB1	1.50	PE 227	11/16"	9/16"	1-3/4"	2 EA
LSB2	1.95	PE 225	7/8"	9/16"	1-3/4"	2 EA
LSB4	1.95	PE226	11/16"	1/2"	1-3/4"	2 EA
LSB5	1.95	PE224	7/8"	1/2"	1-3/4"	2 EA
LSB182	2.50	PE182	7/8"	1/2"	11/16"	1 EA

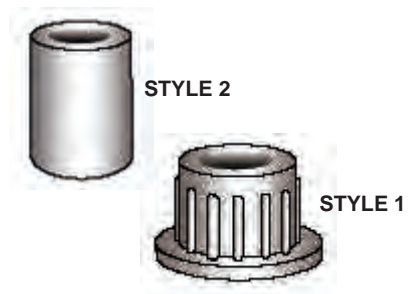

AXLES, HUBS & SPRINGS

- tires & wheels
- axles, hubs & springs
- tongue accessories
- hitches
- electrical
- brake parts
- trailer hardware
- locks & pins
- towing & loading
- tie downs
- tools
- chemicals

EQUALIZERS

- Sold each
- With nylon bushing

PART #	MFG #	LENGTH (L)	HEIGHT (H)	BUSHING ID (D)	BUSHING PART #
690990	13-10	6.06"	4"	9/16" (3)	LSB1
690991	13-104	5.70"	2.03"	9/16" (3)	LSB1
690992	E-1 A2252CB34	7.75"	2.88"	9/16" (3)	LSB1
324001	A2252CB34	7.75"	2.88"	9/16" (2) 3/4" (1)	LSB1

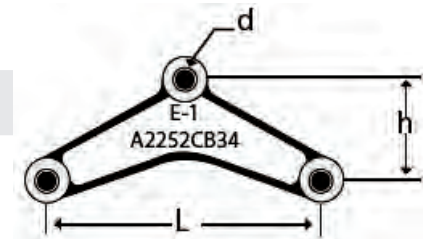
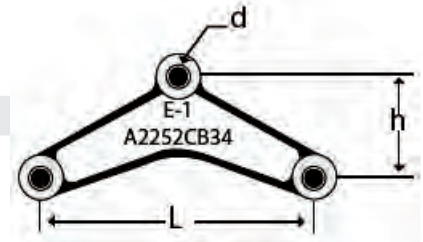
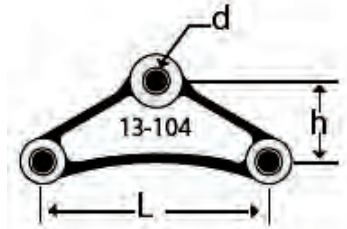
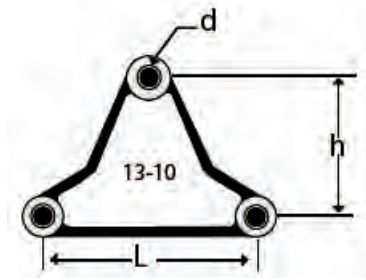

TRAILER

AUTOMATIC DISTRIBUTORS

Your Powersports Distributor For

PARTS, ACCESSORIES & APPAREL

SNOWMOBILE • OFFROAD • STREET • ATV/UTV • PWC/MARINE • TRAILER • OUTERWEAR

GREASEABLE WHEEL BEARING PROTECTORS

BEARING BUDDY

- Sold in pairs only
- The ultimate in wheel bearing protection for your trailer
- Replaces dust cap on trailer hub for easy lubrication and maximum protection
- Prevents bearing failure, keeps water and dirt out of hubs
- Bearings receive constant lubrication, never need to be repacked
- Quick lubricant check level
- Quality construction: heavy chrome plated barrel, stainless steel internal parts



PART #	MFG #	FITS HUBS	OUTER BEARING	OUTER CUP	BUDDY BRA	U/M
BB1781	24.35	41202	1-3/4"	LM11949	LM11910	BB17 PR
BB1980	25.26	42102	2"	LM44643 LM44649	LM44610	BB19 PR
BB2328	31.07	43102	2-5/16"	LM67048	LM67010	BB23 PR

BEARING BUDDY II WITH AUTO CHECK

- Sold in pairs only
- Visual lubricant and pressure indicator
- Fits 2" hubs
- Blue ring recessed



PART #	MFG #	FITS HUBS	OUTER BEARING	OUTER CUP	BUDDY BRA	U/M
BB1985	26.13	42202	2"	LM44643	LM44610	BB19 PR

BEARING BUDDY BRA

- Sold in pairs only
- Bearing Buddy Bras fit over Bearing Buddys to capture grease that can be thrown onto the wheels when the automatic pressure relief feature releases excess grease
- Blister packaged

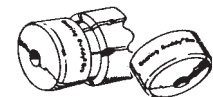

PART #	MFG #	FITS HUBS	BEARING BUDDY	U/M
BB17	6.41	70017	BB1781	PR
BB19	6.41	70019	BB1980/ BB1985	PR
BB23	6.41	70023	BB2328	PR

FULTON WHEEL BEARING PROTECTORS

- Sold in pairs only
- Provide permanent protection against damage from water and dirt entering the wheel bearings
- Prevent corrosion resulting from water entering the hub when the trailer wheels are suddenly submerged
- Automatically maintain the correct internal pressure - can not damage seals



PART #	MFG #	FITS HUBS	OUTER BEARING	OUTER CUP	COVER INCLUDED	PROTECTOR COVER	U/M
FT198	20.75	BPC1980604	2"	LM44643/ LM44649	LM44610	YES	444001 PR
FT232*	26.65	BP232S0604	2-5/16"	LM67048	LM67010	NO	444002 PR



*FT232 HUB NOT COUNTER BORED. ** FT244 HUB COUNTER BORED.

- tires & wheels
- axles, hubs & springs
- tongue accessories
- hitches
- electrical
- brake parts
- trailer hardware
- locks & pins
- towing & loading
- tie downs
- tools
- chemicals

AXLES, HUBS & SPRINGS

- tires & wheels
- axles, hubs & springs
- tongue accessories
- hitches
- electrical
- brake parts
- trailer hardware
- locks & pins
- towing & loading
- tie downs
- tools
- chemicals

GREASEABLE WHEEL BEARING PROTECTORS CONTINUED

TIE DOWN WHEEL BEARING PROTECTOR

- Sold in pairs only
- Pumps grease directly into bearing
- 1.98" OD
- 2 to a card
- Skin packaged



PART #	MFG #	FITS HUBS	OUTER BEARING	OUTER CUP	COVER INCLUDED	PROTECTOR COVER	U/M	
LR81168	15.95	81168	2"	LM44643/ LM44649	LM44610	YES	-	PR

TIE DOWN WHEEL BEARING PROTECTOR COVER

PART #	MFG #	FITS HUBS	BEARING PROTECTOR	U/M	
LR81174	6.95	81174	2"	LR81168	PR



NON GREASEABLE DUST CAPS

PART #	MFG #	SIZE	U/M	
GCP34	4.95	GC-2	1-3/4"	EA
GCP10	1.50	16200	1-15/16"	EA
LR81167	7.95	81167	1-15/16"	PR
856658	14.57	6658	2-7/16"	PR
855652	8.63	5652	2-1/2"	EA



LR81167

CONE BEARINGS AND BEARING CUPS ONLY

Sold each



CONE BEARING PART #	CONE BEARING MFG #	BEARING CUP PART #	BEARING CUP MFG #	SPINDLE SIZE	INSIDE DIAMETER	OUTSIDE DIAMETER
LM11949	11.95	LM-11949	LM11910	3/4"	0.75"	1.781"
LM44643	6.95	L44643	LM44610	1"	1"	1.98"
LM44649	6.95	L-44649	LM44610	1-1/16"	1.0625"	1.98"
LM67048	6.32	LM-67048	LM67010	1-1/4"	1.25"	2.328"
LM15123	7.55	LM15123	LM15245	1-1/4"	1.25"	2.4409"
LM14125A	10.12	14125A	----	1-1/4"	1.25"	2.717"
LM68149	6.35	LM68149	LM68111	1-3/8"	1.3775"	2.3612"
LM48548	7.58	LM48548	LM48510	1-3/8"	1.375"	2.5625"
LM25580	13.95	L-25580	LM25520	1-3/4"	1.75"	3.265"

TRAILER

BEARING AND CUP PACKAGED

PART #	MFG #	SPINDLE SIZE	BEARING	CUP	INSIDE DIAMETER	OUTSIDE DIAMETER	WIDTH	
LM11949CC	9.95	L11940/11949CC	3/4"	LM11949	LM11910	0.75"	1.781"	0.61"
LM44643CC	5.95	LM44610/L44643	1"	LM44643	LM44610	1"	1.98"	0.56"
LM67048CC	6.95	L67010/67048	1-1/4"	LM67048	LM67010	1.25"	2.328"	0.625"
LM15123CC	8.95	LM15123/LM15245	1-1/4"	LM15123	LM15245	1.25"	2.4409"	0.715"
LM68149CC	6.95	LM68111/LM68149	1-3/8"	LM68149	LM68111	1.3775"	2.3612"	0.625"
LM48548CC	9.95	L48510/48548	1-3/8"	LM48548	LM48510	1.375"	2.5625"	0.71"
LM25580CC	12.95	LM25580/LM25520	1-3/4"	LM25580	LM25520	1.75"	3.265"	0.9375"

GREASE SEALS

PART #	MFG #	ID	OD	UM	
GS204020	2.95	GS-3	1.125"	1.780"	EA
LR81311	8.95	81311	1.125"	1.780"	PR
GS203025	0.95	12192TB	1.250"	1.980"	EA
LR81310	7.95	81310	1.250"	1.980"	PR
GS150198	1.95	15192TB	1.500"	1.987"	EA
GS203013	2.95	GS-4	1.500"	2.330"	EA
LR81312	11.95	81312	1.500"	2.330"	PR
GS545138	1.95	171255T	1.720"	2.565"	EA
LR81313	8.95	81313	1.720"	2.565"	PR
855607	10.56	5607	1.750"	2.330"	PR
855606	1.95	21333TB	2.125"	3.376"	EA
855605	1.95	22333TB	2.250"	3.376"	EA
856605	11.70	6605	2.750"	2.376"	PR



BEARING KITS

- Kits are retail packaged
- All kits are complete with 2 bearings, 2 cups, 1 grease seal, and 1 cotter pin



PART #	MFG #	SPINDLE SIZE	INNER BEARING	OUTER BEARING	INNER CUP	OUTER CUP	GREASE SEAL	COTTER PIN		
TBK3	22.95	WB750-0700	3/4"	LM11949	LM11949	LM11910	LM11910	GS204020	CP2	0.95
TBK1	14.95	WB100 0700	1"	LM44643	LM44643	LM44610	LM44610	GS203025	CP2	0.95
TBK9	12.95	WB106-0700	1-1/16"	LM44649	LM44649	LM44610	LM44610	GS203025	CP2	0.95
TBK4	16.95	WB125-0700	1-1/4"	LM67048	LM67048	LM67010	LM67010	GS203013	CP2	0.95
TBK8	20.95	WB125T0700	1-1/4"-3/4"	LM67048	LM11949	LM67010	LM11910	GS203013	CP2	0.95
TBK5*	18.95	----	1-3/8"-1-1/16"	LM48548	LM44649	LM48510	LM44610	GS545138	CP2	0.95
TBK6*	16.95	WB138T0700	1-3/8"-1-1/16"	LM68149	LM44649	LM68111	LM44610	GS545138	CP2	0.95
TBK10	22.95	----	1-3/4"-1-1/4"	LM25580	LM67048	LM25520	LM67010	855605	CP2	0.95

*TBK5 = OLD STYLE HSH545 HUB, *TBK6 = NEW STYLE

tires & wheels

axles, hubs & springs

tongue accessories

hitches

electrical

brake parts

trailer hardware

locks & pins

towing & loading

tie downs

tools

chemicals

AXLES, HUBS & SPRINGS

TIE DOWN U-BOLTS

Pairs of U-bolts are packaged with nuts and washers.
All U-bolts are zinc plated to prevent rust.



LR86205

LR86217

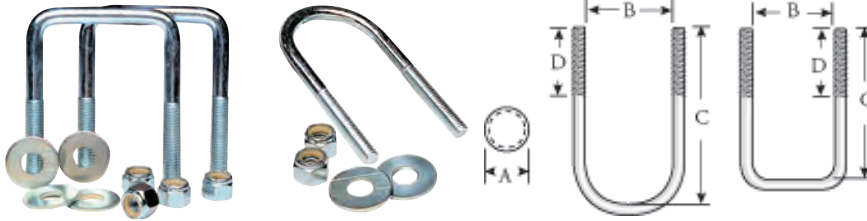

How to measure for u-bolts:

- A = Rod width - threads per inch
- B = Between leg length (inside thread)
- C = Leg length
- D = Thread length

PART #	MFG #	"A" ROD WIDTH	"B" BETWEEN LEG	"C" LEG LENGTH	"D" THREAD LENGTH	SQUARE/ ROUND	NUTS/ WASHERS	U/M	
LR86209	4.55	3/8-16	3-1/8"	3"	1-3/4"	SQUARE	YES	PR	
LR86219	4.35	3/8-16	1-5/8"	3-9/16"	1-3/4"	SQUARE	YES	PR	
LR86208	4.75	3/8-16	2-1/8"	4"	1-3/4"	SQUARE	YES	PR	
LR10967	1.60	10967Z	3/8-16	1-3/4"	4-13/16"	1-3/4"	ROUND	NO	EA
LR86216	5.15	3/8-16	1-3/4"	4-13/16"	1-3/4"	ROUND	YES	PR	
LR83707	1.30	83707Z	7/16-14	2-1/16"	2-5/16"	1"	SQUARE	NO	EA
LR86228	4.85	7/16-14	2-1/16"	2-5/16"	1"	SQUARE	YES	PR	
LR83704	1.80	83704Z	7/16-14	4-1/16"	2-13/16"	1-3/4"	SQUARE	NO	EA
LR86234	5.80	7/16-14	4-1/16"	2-13/16"	1-3/4"	SQUARE	YES	PR	
LR86230	5.80	83708Z	7/16-14	3-1/16"	3-5/16"	1-3/4"	SQUARE	YES	PR
LR10989	1.65	10989Z	7/16-14	1-9/16"	3-9/16"	2"	SQUARE	NO	EA
LR86212	5.45	7/16-14	1-9/16"	3-9/16"	2"	SQUARE	YES	PR	
LR86229	6.05	7/16-14	2-1/16"	4-5/16"	2"	SQUARE	YES	PR	
LR83703	2.05	83703Z	7/16-14	3-1/16"	4-5/16"	2"	SQUARE	NO	EA
LR86231	6.35	7/16-14	3-1/16"	4-5/16"	2"	SQUARE	YES	PR	
LR86205	6.55	1/2-13	3-1/8"	3"	1-1/2"	SQUARE	YES	PR	
LR10983	2.15	10983Z	1/2-13	4-1/8"	3"	2"	SQUARE	NO	EA
LR86207	7.25	1/2-13	4-1/8"	3"	2"	SQUARE	YES	PR	
LR84430	2.25	84430Z	1/2-13	3-1/16"	3-13/16"	1-1/2"	SQUARE	NO	EA
LR86214	7.15	1/2-13	3-1/16"	3-13/16"	1-1/2"	SQUARE	YES	PR	
LR84503	2.15	84503Z	1/2-13	2-1/8"	4"	2"	SQUARE	NO	EA
LR86204	13.59	1/2-13	2-1/8"	4"	2"	SQUARE	YES	PR	
LR86206	7.35	1/2-13	3-1/8"	4"	2"	SQUARE	YES	PR	
LR10991	2.05	10991Z	1/2-13	1-9/16"	4-1/16"	2"	SQUARE	NO	EA
LR86213	6.75	1/2-13	1-9/16"	4-1/16"	2"	SQUARE	YES	PR	
LR84406	2.45	84406Z	1/2-13	2-1/16"	4-13/16"	2"	SQUARE	NO	EA
LR86215	7.55	1/2-13	2-1/16"	4-13/16"	2"	SQUARE	YES	PR	
LR84751	2.65	84751Z	1/2-13	2-3/8"	5-3/8"	2"	ROUND	NO	EA
LR86217	8.05	1/2-13	2-3/8"	5-3/8"	2"	ROUND	YES	PR	
LR84758	2.87	84758Z	1/2-13	3-1/16"	6-11/16"	2"	ROUND	NO	EA
LR86218	9.50	1/2-13	3-1/16"	6-11/16"	2"	ROUND	YES	PR	

TRAILER

- tires & wheels
- axles, hubs & springs
- tongue accessories
- hitches
- electrical
- brake parts
- trailer hardware
- locks & pins
- towing & loading
- tie downs
- tools
- chemicals

TIE DOWN U-BOLT KITS

Used for mounting brackets to trailer frame. Zinc plated to help prevent rusting. Includes flat washers and nyloc nuts.

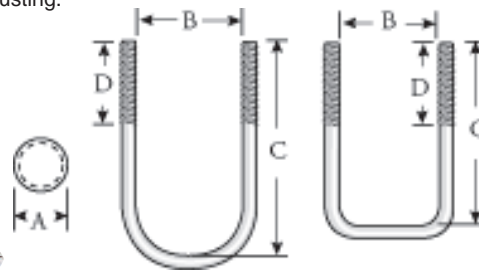

How to measure for u-bolts:

- A = Rod width - threads per inch
- B = Between leg length (inside thread)
- C = Leg length
- D = Thread length

PART #	MFG #	"A" ROD WIDTH	"B" BETWEEN LEG	"C" LEG LENGTH	"D" THREAD LENGTH	SHAPE	EACH/PAIR
LR86204	13.59	86204	1/2"-13	2-1/8"	4"	2"	SQUARE PAIR
276005	9.47	86205	1/2"-13	3-1/8"	3"	1-1/2"	SQUARE PAIR
276006	9.83	86206	1/2"-13	3-1/8"	4"	2"	SQUARE PAIR
276007	10.02	86207	1/2"-13	4-1/8"	3"	2"	SQUARE PAIR
276008	10.23	86208	3/8"-16	2-1/8"	4"	1-3/4"	SQUARE PAIR
276009	9.18	86209	3/8"-16	3-1/8"	3"	1-3/4"	SQUARE PAIR
276010	9.47	86210	3/8"-16	3-1/8"	4"	1-3/4"	SQUARE PAIR
276011	9.63	86211	3/8"-16	4-1/8"	3"	1-3/4"	SQUARE PAIR
276012	5.26	86212	7/16"-14	1-9/16"	3-9/16"	2"	SQUARE EACH
276013	6.20	86213	1/2"-13	1-9/16"	4-1/16"	2"	SQUARE EACH
276014	6.10	86214	1/2"-13	3-1/16"	3-13/16"	1-1/2"	SQUARE EACH
276015	6.59	86215	1/2"-13	2-1/16"	4-13/16"	2"	SQUARE EACH
276016	4.59	86216	3/8"-16	1-3/4"	4-13/16"	1-3/4"	ROUND EACH
276017	7.90	86217	1/2"-13	2-3/8"	5-3/8"	2"	ROUND EACH
276018	8.22	86218	1/2"-13	3-1/16"	6-11/16"	2"	ROUND EACH
276019	5.00	86219	3/8"-16	1-5/8"	3-9/16"	1-3/4"	SQUARE EACH
276020	5.14	86228	7/16"-14	1-9/16"	3-9/16"	2"	SQUARE EACH
276021	5.99	86229	7/16"-14	2-1/16"	4-5/16"	2"	SQUARE EACH
276022	6.68	86230	7/16"-14	3-1/16"	3-5/16"	1-3/4"	SQUARE EACH
276023	5.29	86231	7/16"-14	3-1/16"	4-5/16"	2"	SQUARE EACH
276024	6.16	86234	7/16"-14	4-1/16"	2-13/16"	1-3/4"	SQUARE EACH

LOCK NUTS



PART #	MFG #	SIZE	U/M
LR10627	0.56	10627	3/8"-16 EA
LR10654	0.25	10654	7/16"-14 EA
LR10645	0.37	10645	1/2"-13 EA

WASHERS



PART #	MFG #	SIZE	U/M
LR10502	0.23	10502	3/8" EA
LR10510	0.25	10510	7/16" EA
LR10573	0.40	10573	1/2" EA

- tires & wheels
- axles, hubs & springs
- tongue accessories
- hitches
- electrical
- brake parts
- trailer hardware
- locks & pins
- towing & loading
- tie downs
- tools
- chemicals

AXLES, HUBS & SPRINGS



- tires & wheels
- axles, hubs & springs
- tongue accessories
- hitches
- electrical
- brake parts
- trailer hardware
- locks & pins
- towing & loading
- tie downs
- tools
- chemicals

SMITH U-BOLTS

- Contains parts to attach two springs to axle
- Includes 2 tie plates, 4 u-bolts, 8 locknuts, and washers

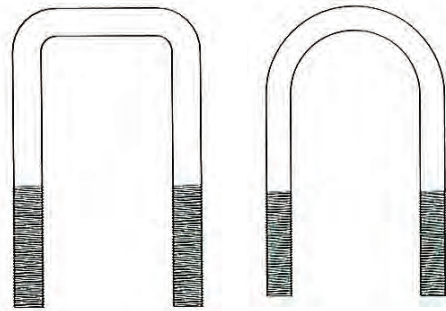

ZINC, YELLOW

PART #	MFG #	A ROD WIDTH	B BETWEEN LEG	C LEG LENGTH	D THREAD LENGTH	SQUARE/ ROUND	NUTS/ WASHERS	U/M	
CS22003	2.95	22003ZN	3/8"-16	1-5/8"	3-3/8"	2-1/2"	SQUARE	NO	EA
CS21008	2.25	21008ZN	3/8"-16	1-15/16"	4"	1-1/2"	ROUND	NO	EA
CS22017	4.95	22017ZY	1/2"-20	2.12"	4-1/2"	2"	SQUARE	NO	EA
CS21000	4.95	21000ZN	1/2"-20	3-1/8"	7"	2"	ROUND	NO	EA



ZINC PLATED

PART #	MFG#	A ROD WIDTH	B BETWEEN LEG	C LEG LENGTH	D THREAD LENGTH	SQUARE/ ROUND	NUTS/ WASHERS	U/M	
CS15251	10.74	15251	7-16"-14	2-1/8"	4"	2"	SQUARE	NO	EA
CS15252	1.95	15252	7-16"-14	3-1/8"	3"	2-1/4"	SQUARE	NO	EA
CS15253	10.78	15253	7-16"-14	3-1/8"	4"	2-1/4"	SQUARE	NO	EA
CS15254	2.95	15254	7-16"-14	4-1/8"	4"	2-1/4"	SQUARE	NO	EA

TRAILER

WASHERS



PART #	MFG #	SIZE	U/M	
CS10961	0.95	10961	7/16"	EA

LOCK NUTS



PART #	MFG #	SIZE	U/M	
CS10811	0.95	10811	7/16"-14	EA

ADDITIONAL U-BOLTS

PART #	MFG #	A ROD WIDTH	B BETWEEN LEG	C LEG LENGTH	D THREAD LENGTH	SQUARE/ ROUND	NUTS/ WASHERS	UM	
690950	2.00	11-54	3/8"-24	1-7/8"	4-1/4"	1-3/4"	ROUND	NO	EA
827046	1.25	US7301213Y	7/16"-14	3-1/16"	2-13/16"	2"	SQUARE	NO	EA
827050	1.50	US7301405Y	7/16"-14	3-1/16"	4-5/16"	2"	SQUARE	NO	EA

RELIABLE U-BOLTS



U-BOLTS SOLD EACH

PART #	MFG #	LEG WIDTH	LENGTH	BOLT DIA.	THREAD LENGTH	U/M	
230045	10.99	UB-R-120	1-3/4"	4-1/4"	1/2"	2"	EA
230046	10.96	UB-R-220	2-1/2"	5-1/4"	1/2"	2-1/4"	EA
230047	10.64	UB-R-320	3-1/8"	6"	1/2"	2"	EA
230048	6.35	UB-R-322	3-1/8"	7"	1/2"	2"	EA
230049	5.95	UB-S-220	2-1/8"	4-1/2"	1/2"	2"	EA

ITEM	PART #	MFG #	SIZE	U/M
WASHER	230051	6.73	SW1001 1-1/16"	EA
LOCK NUT	230040	0.60	N-101 1/2"	EA

U-BOLT KITS

- Each kit contains:
 - 4 u-bolts
 - 2 tie plates
 - 8 lock nuts & washers
- Display packaged

PART #	MFG #	AXLE SIZE	AXLE STYLE	BETWEEN LEG	U/M	
RL3001	65.53	3001	1-3/4"	ROUND	1-1/4"	PKG
RL3003	56.86	3003	2-3/8"	ROUND	1-1/4"	PKG
RL3005	62.75	3005	3"	ROUND	1-3/4"	PKG
RL3011	47.12	3011	2"	SQUARE	1-3/4"	PKG



Display packaged



Back View

- All u-bolts are:
- 1/2"-20 thread
 - Zinc plated
 - Boxed (bulk)

PART #	MFG #	AXLE SIZE	AXLE STYLE	U-BOLT	TIE PLATE	LOCK NUTS	U/M	
75-1010	25.05	UBK-R120	1-3/4"	ROUND	230045	230041	230040	PKG
75-1014	34.95	UBK-R220	2-3/8"	ROUND	230046	230042	230040	PKG
75-1016	32.65	UBK-R320	3"	ROUND	230047	230043	230040	PKG
75-1018	35.60	UBK-R322	3"	ROUND	230048	230043	230040	PKG
75-1022	37.80	UBK-R372	3"	ROUND	230048	230044	230040	PKG
75-1026	34.40	UNK-S220	2"	SQUARE	230049	230044	230040	PKG

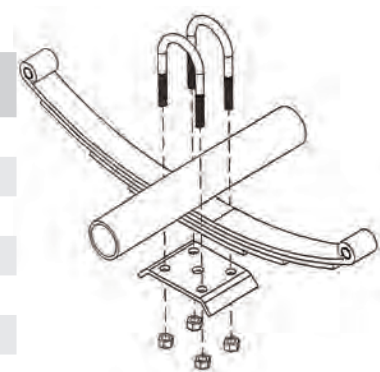

- tires & wheels
- axles, hubs & springs
- tongue accessories
- hitches
- electrical
- brake parts
- trailer hardware
- locks & pins
- towing & loading
- tie downs
- tools
- chemicals

AXLES, HUBS & SPRINGS

- tires & wheels
- axles, hubs & springs
- tongue accessories
- hitches
- electrical
- brake parts
- trailer hardware
- locks & pins
- towing & loading
- tie downs
- tools
- chemicals

SMITH AXLE TIE PLATES

Galvanized steel • 1/4" thick

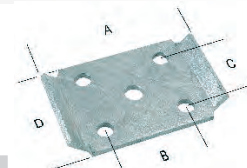

FORMED

PART #	MFG #	A	B	C	D	U-BOLT	HOLE DIAMETER	U/M
CS20001	6.95 20001G	5.83"	2.94"	2.31"	3.75"	1/2"	.56"	EA
CS20003	5.95 20003G	5.83"	3.62"	2.26"	3.75"	1/2"	.56"	EA

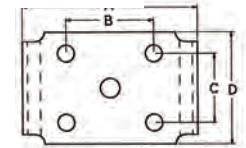

FLAT

PART #	MFG #	A	B	C	D	U-BOLT	HOLE DIAMETER	U/M
CS20015	3.95 20015G	3.5"	2.25"	2.25"	3.5"	3/8"	.44"	EA
CS20022	2.95 20022G	3.5"	2.25"	2"	3"	3/8"	.44"	EA
CS20023	4.95 20023GA	4"	2.63"	2.38"	3.81"	1/2"	.56"	EA
CS20044	4.95 20044GA	5"	2.75"	2.38"	3.75"	1/2"	9/16"X13/16" SLOTS	EA

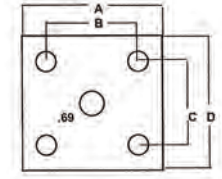
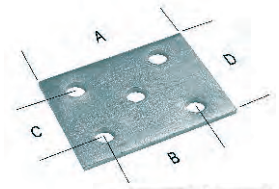

THREE HOLE FLAT

PART #	MFG #	A	B	C	U-BOLT	UM
CS20024	1.95 20024G	5"	3.56"	1.5"	1/2"	EA

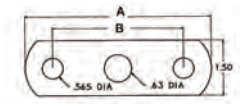
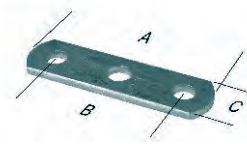

AXLE TIE PLATES

Oiled Finish • 1/4" Thick • These plates are recommended for 3" round axles • Sold each (bulk)



TWO HOLE FLAT

PART #	MFG #	A	B	C	D	U/M
828474	2.10 28-01255-0	-	4-1/2"	-	1/2"	EA

TIE DOWN TIE PLATE

Sold 2 to a package



PART #	MFG #	A	B	C	D	U-BOLT	HOLE DIAMETER	U/M
LR81186	14.95 81186	5"	2-15/16"	2-1/2"	3-3/4"	1/2"	9/16"X13/16" SLOTS	PR

AXLE TIE PLATES

PART #	MFG #	A LONG LENGTH	B SHORT LENGTH	C BOLT SPACE LONG	D BOLT SPACE SHORT	HOLE DIA.	U/M
230041	5.90 TP-R-120	3-1/2"	3-1/2"	2-1/4"	2-1/4"	1/2"	EA
230042	9.95 TP-R-220	5-1/2"	3-1/2"	3"	2-1/2"	1/2"	EA
230043	9.70 TP-R-320	5-3/4"	3-1/2"	3-1/2"	2-1/4"	1/2"	EA
230044	10.40 TP-R-370	5-3/4"	4"	3-1/2"	2-1/2"	1/2"	EA
230050	7.65 TP-S-220	3-3/4"	3-3/4"	2-3/4"	2-3/4"	1/2"	EA

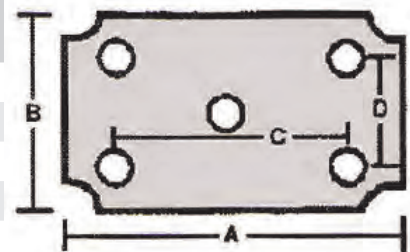

TRAILER

TIE DOWN AXLE TIE PLATE KITS

- Each kit contains:
 - 4 u-bolts
 - 8 lock nuts
 - 2 five hole tie plates
- Display packaged

PART #	MFG #	AXLE SIZE	AXLE STYLE	U/M	
LR81175	40.95	81175	1.90"	ROUND	PKG
LR81180	46.95	81180	2-3/8"	ROUND	PKG
LR81185	59.95	81185	2"	SQUARE	PKG

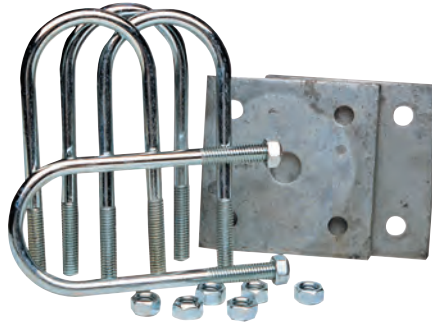

SMITH AXLE TIE PLATE KITS

- Zinc, yellow u-bolts
- Fits 1-3/4" wide springs
- Contains parts to attach 2 springs to axle
- Galvanized plates
- Includes: 2 tie plates, 4 u-bolts, 8 locknuts, & washers
- Display packaged

PART #	MFG #	AXLE SIZE	AXLE STYLE	U/M	
CS23000	37.20	23000	1-3/4"	ROUND	PKG
CS23002	52.61	23002	2-3/8"	ROUND	PKG
CS23003	47.48	23003	3"	ROUND	PKG
CS23102	28.21	23102	1-1/2"	SQUARE	PKG
CS23103	42.33	23103	2"	SQUARE	PKG

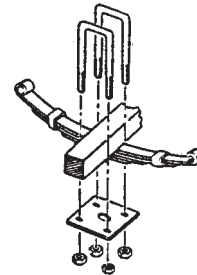

Square

SMITH FRAME STRAPS

- Heavy 1/4" steel
- Use with 7/16" or 1/2" diameter u-bolts or shackle bolts



GALVANIZED FINISH

PART #	MFG #	LENGTH	HOLE CENTER	WIDTH	BOLT HOLE SIZE	U/M	
CS20016	11.52	20016G	4"	2-9/16"	1-1/4"	.565"	EA
CS20017	14.05	20017G	5"	3-1/2"	1-1/4"	.565"	EA
CS20018	1.95	20018G	4"	2.58"	1"	.565"	EA
CS20028	16.64	20028G	6"	4.53"	1-1/4"	.565"	EA

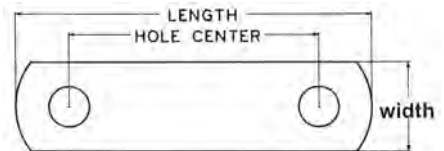

PLAIN FINISH

PART #	MFG #	LENGTH	HOLE CENTER	WIDTH	BOLT HOLE SIZE	U/M	
690962	2.81	14100G	4-3/8"	3-1/4"	1-1/4"	9/16"	EA

TIE DOWN FRAME STRAPS

- Used on double eye springs
- 1/4" thick plated steel
- Skin packaged (each)



PART #	MFG #	LENGTH	HOLE CENTER	WIDTH	BOLT HOLE SIZE	U/M	
LR86276	13.95	86276	4-3/8"	3-1/4"	1-1/4"	9/16"	EA

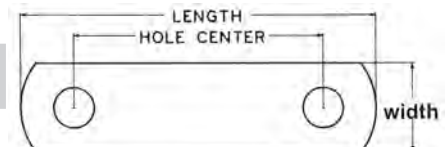

FAST SAME DAY SHIPPING

- tires & wheels
- axles, hubs & springs
- tongue accessories
- hitches
- electrical
- brake parts
- trailer hardware
- locks & pins
- towing & loading
- tie downs
- tools
- chemicals

AXLES, HUBS & SPRINGS

- tires & wheels
- axles, hubs & springs
- tongue accessories
- hitches
- electrical
- brake parts
- trailer hardware
- locks & pins
- towing & loading
- tie downs
- tools
- chemicals

TRAILER

TIE DOWN SPRING HANGERS - WELD-ON

- Weld-on
- Sold each
- Front bracket and rear "C" clip bracket
- Use with 1-3/4" spring and 9/16" shackle bolt

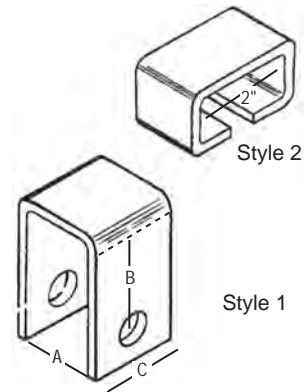

PART #	MFG #	A	B	C	STYLE	LOCATION	WEIGHT LIMIT PER AXLE	U/M	
LR86274	9.95	86274	2-1/4"	1-1/2"	1-1/2"	1	FRONT	1000#-3500#	EA
LR86275	7.95	86275	2"	1"	1"	2	REAR	5200#-8000#	EA

SMITH SPRING HANGERS - BOLT ON

- Hot-dipped galvanized brackets bolt beneath trailer frame
- For light duty use with 1-3/4" slipper springs
- Front bracket length of 2-1/4"
- Made of 7 gauge steel
- Uses 9/16" shackle bolt below

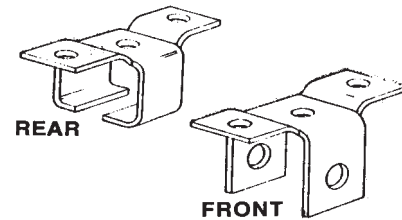

PART #	MFG #	SPRING	LOCATION	BOLT	LENGTH	U/M	
CS14016	15.36	14016G	1-3/4"	FRONT	9/16"	2-1/4"	EA
CS14017	14.06	14017G	1-3/4"	REAR	9/16"	2-1/2"	EA

SMITH FLUTED SHACKLE BOLTS AND NUTS

- For use with spring hanger brackets
- Fluting prevents the bolt from turning, which can wear hanger brackets
- Case hardened grade 5 steel



SOLD EACH

PART #	MFG #	DESCRIPTION	SIZE	THREAD	LENGTH	U/M	
CS11030B	1.95	11030	BOLT	9/16"	18NF	3"	EA
CS11031B	4.50	11031	BOLT	9/16"	18NF	3-1/2"	EA
CS10864	0.95	10864	NUT	9/16"	18NF	-	EA

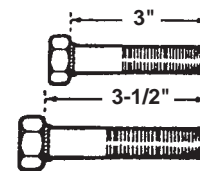

2 BOLTS AND 2 NUTS PER PACKAGE

PART #	MFG #	DESCRIPTION	SIZE	THREAD	LENGTH	U/M	
230015	5.95	230015	BOLT AND NUT	9/16"	18NF	3"	PKG



TIE DOWN HEX HEAD BOLTS

- Use for mounting brackets, couplers, and winch stands
- Grade 5, zinc plated steel
- Package contains 4 bolts, 4 washers, and 4 lock nuts



PART #	MFG #	SIZE	LENGTH	U/M	
LR86256	2.50	86256	7/16"	1"	PKG

AXLES, HUBS & SPRINGS

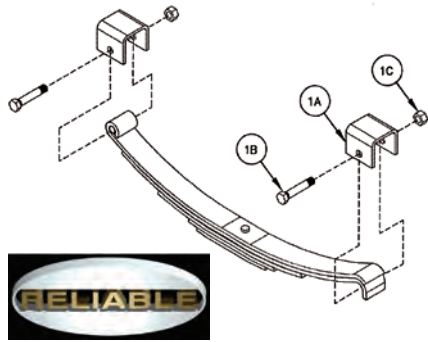

SINGLE AXLE HANGER KIT - SLIPPER STANDARD DUTY (1-3/4" SPRING)

DETAIL	PART #	MFG #	DESCRIPTION	KIT QTY
	75-1000	47.54	HK1-S100 SINGLE AXLE HANGER KIT (1-3/4" SPRING)	COMPLETE
DETAIL	PART #	MFG #	DESCRIPTION	KIT QTY
1A	75-101*	10.42	HG-101 Front, rear hanger - 1.44"	4**
1B	CS11030B*	1.95	11030 Bolt - 9/16" - 18 x 3" long	4**
1C	CS10864*	0.95	10864 Nut - 9/16" - 18 NFT	4**
NOTES:				
*	Sold each			
**	Quantity per kit			

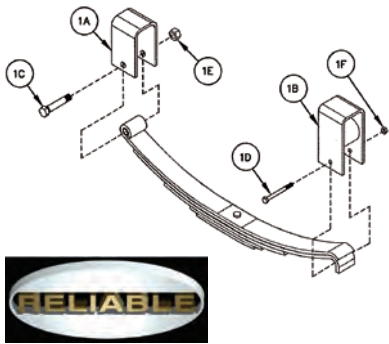

SINGLE AXLE HANGER KIT - SLIPPER HEAVY DUTY (2" SPRING)

DETAIL	PART #	MFG #	DESCRIPTION	KIT QTY
	75-1002	68.60	HK1-S201 SINGLE AXLE HANGER KIT (2" SPRING)	COMPLETE
DETAIL	PART #	MFG #	DESCRIPTION	KIT QTY
1A	75-103*	23.48	HG-103 Front hanger - 4.25"	2**
1B	75-105*	26.05	HG-105 Rear hanger - 5.30"	2**
1C	CS11031B*	4.50	11031 Bolt - 9/16" - 18 x 3-1/2" long	2**
1D	75-110*	1.15	B-100 Bolt - 5/16" - 18 x 3-1/2" long	2**
1E	CS10864*	0.95	10864 Nut - 9/16" - 18 NFT	2**
1F	75-112*	0.20	N-100 Nut - 5/16" - 18 NFT	2**
NOTES:				
*	Sold each			
**	Quantity per kit			

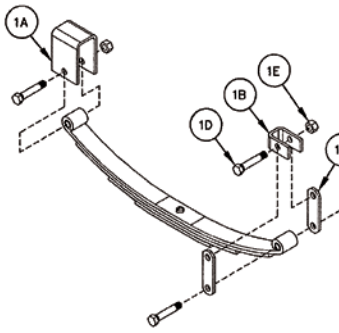

SINGLE AXLE HANGER KIT - DOUBLE EYE (SHORT & LONG) - (1-3/4" SPRING)

DETAIL	PART #	MFG #	DESCRIPTION	KIT QTY
	75-1100	34.22	HK1-D100 SINGLE AXLE HANGER KIT (SHORT)	COMPLETE
	75-1101	61.98	HK1-D101 SINGLE AXLE HANGER KIT (LONG)	COMPLETE
DETAIL	PART #	MFG #	DESCRIPTION	KIT QTY
1A	75-101*	10.42	HG-101 Front hanger for 75-1100 - 1.44"	2**
1A	75-102*	15.40	HG-102 Front hanger for 75-1101 - 3.25"	2**
1B	75-100*	2.05	HG-100 Rear hanger - 1.12"	1**
1C	75-120*	5.44	SHL-102 Shackle link - 3-1/8" hole centers	4**
1D	CS11030B*	1.95	11030 Bolt - 9/16" - 18 x 3" long	6**
1E	CS10864*	0.95	10864 Nut - 9/16" - 18 NFT	6**
NOTES:				
*	Sold each			
**	Quantity per kit			

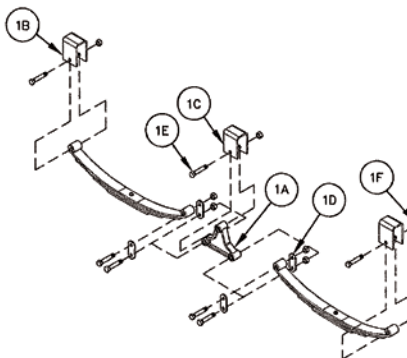

TANDEM AXLE EQUALIZER KIT - (SHORT & LONG) - (1-3/4" SPRING)

DETAIL	PART #	MFG #	DESCRIPTION	KIT QTY
	75-1102	82.65	EK2-D102 TANDEM AXLE EQUALIZER KIT (SHORT)	COMPLETE
	75-1103	269.62	EK2-D103 TANDEM AXLE EQUALIZER KIT (LONG)	COMPLETE
DETAIL	PART #	MFG #	DESCRIPTION	KIT QTY
1A	690990*	17.95	13-10 Equalizer bar	2**
1B	75-101*	10.42	HG-101 Front, center, rear hanger for 75-2102 - 1.44"	6**
1C	75-102*	15.40	HG-102 Front, center, rear hanger for 75-2103 - 3.25"	6**
1D	75-120*	5.44	SHL-102 Shackle link - 2" hole centers	8**
1D	CS11030B*	1.95	11030 Bolt - 9/16" - 18 x 3" long	14**
1E	CS10864*	0.95	10864 Nut - 9/16" - 18 NFT	14**
NOTES:				
*	Sold each			
**	Quantity per kit			

tires & wheels

axles, hubs & springs

tongue accessories

hitches

electrical

brake parts

trailer hardware

locks & pins

towing & loading

tie downs

tools

chemicals

FAST SAME DAY SHIPPING

TRAILER CATALOG

39

AXLES, HUBS & SPRINGS

- tires & wheels
- axles, hubs & springs
- tongue accessories
- hitches
- electrical
- brake parts
- trailer hardware
- locks & pins
- towing & loading
- tie downs
- tools
- chemicals

MARINE CORROSION CONTROL & TRAILER BEARING GREASE

- A sophisticated lubricant for use in severe operating conditions caused by salt water and salt air
- Water resistant, rust and corrosion preventative
- Recommended for all corrosion marine applications as well as boat trailers, wheel bearings including disc brake bearings



DESCRIPTION	QTY/CS	MFG #	PART #	
1 lb Resealable Tub	12	11404	LB11404	13.95
14 oz Cartridge	10	11402	LB11402	13.95

WHITE LITHIUM GREASE

- Includes zinc additives for a clean, white color
- Ideal for general home, shop, marine, snowmobile and industrial applications
- Provides superior performance and protection in most weather and temperature conditions



DESCRIPTION	QTY/CS	MFG #	PART #	
1 lb Resealable Tub	12	11350	LB11350	10.95
14 oz Cartridge	10	11354	LB11354	11.95

LEVER ACTION GREASE GUN

- Three way loading
- Heavy duty performance
- Display carton packaging
- Uses 14 oz. cartridge
- Zinc plated for maximum rust and corrosion resistance



DESCRIPTION	MFG #	PART #	
Lever Action Grease Gun	30-465	LB11155	40.95

PROFESSIONAL GREASE GUN

- Air bleeder valve eliminates air lock
- Comfort grip lever handle
- Uses standard 14 oz. grease cartridge
- Imported



DESCRIPTION	MFG #	PART #	
Professional Grease Gun	W54202	W54202	25.95

TRAILER



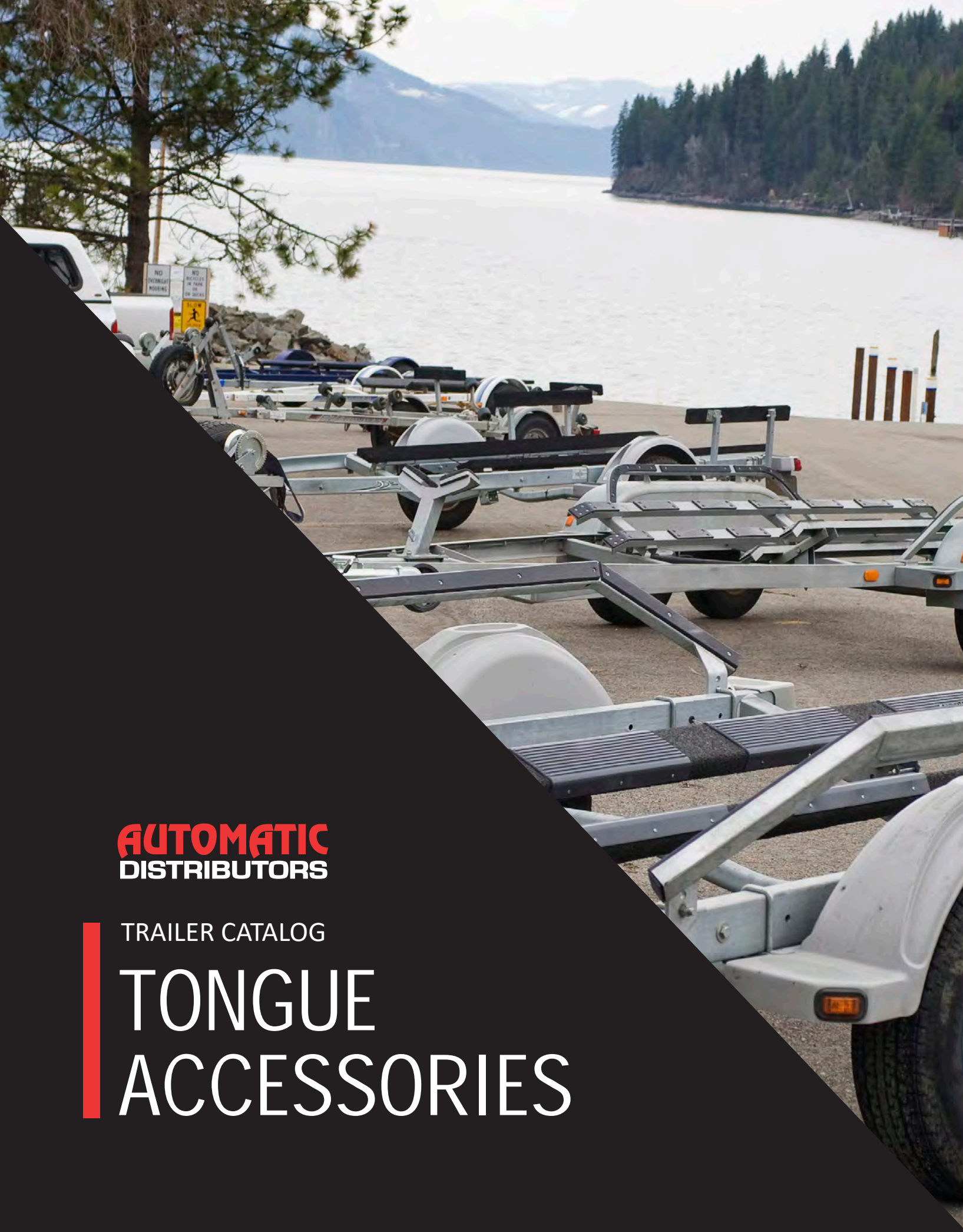

AUTOMATIC
DISTRIBUTORS

TRAILER CATALOG

**TONGUE
ACCESSORIES**

TONGUE ACCESSORIES

F2 JACKS - TWIN & WIDE TRACK (1600 lbs)

Fulton, the industry leader for high performance marine jacks, is proud to introduce a revolution in trailer jack engineering. The F2, designed for use with marine, recreational and utility trailers, continues the Fulton heritage of innovation rethinking every feature and challenging industry conventions. The result is a re-engineered high quality product that will transform the industry. It's so strong and reliable that Fulton is backing it with an unprecedented LIMITED LIFETIME WARRANTY

- Maintenance free - designed to eliminate the need for lubrication and maintenance
- Corrosion resistant coatings cover internal and external components - will hold up in harsh environments
- Ergonomic design - crank, release pin and integrated wheel wedge are made of strong, engineered plastic for a comfortable touch



DESCRIPTION	MFG #	PART #	
F2™ Jack, 1,600 lbs., Twin Track	141302134	444177	407.47
F2™ Jack, 1,600 lbs., Wide Track	141304134	444178	407.47

REPLACEMENT PARTS

DESCRIPTION	MFG #	PART #	
Service Kit - F2 Handle/Crank Kit	500134	444179	43.69
Service Kit - F2 Handle Holdup	500129	444180	16.15
Service Kit - F2 Gearbox Cover Replacement	500135	444181	15.16
Service Kit - F2 Pull Pin Replacement	500136	444182	15.50
Replacement Part - 2 Washers	500137	444183	6.70
Kit - F2 3 x 4 Mount w/ Hardware	500277	444184	54.14
Replacement Part - F2 Gear Kit, Includes: Shim Washer 5/16" (1), Straight Pin 7/32" x 3/4" (1), Groove Pin 3/16" x 1-1/4" (1) & Washer 1/2" ID x 1-1/4" OD (1)	500314	444185	21.25
Jack Accessory, XP to F2 Adapter Kit, For F2 Swivel Mount w/4" Frame	500320	444186	65.31
Service Kit - F2 Twin Track Wheel Replacement	500130	444187	102.55
Service Kit - F2 Twin Track Wheel	500138	444188	45.95
Service Kit - F2 Twin Track Wheel Wedge	500132	444189	38.61
Service Kit - F2 Wide Track Wheel Replacement	500131	444190	80.96
Service Kit -F2 Wide Track Wheel Wedge	500133	444191	43.69



PRO SERIES™ POWERED JACK (2500 lbs)

- 18" travel.
- Integrated circuit breaker.
- Works in case of power loss with supplied manual override crank handle.
- Gloss black painted outer tube and motor assembly, clear zinc inner tube.
- Limited 1-year warranty.

MFG #	PART #	
500198	444175	362.54

REPLACEMENT PARTS

DESCRIPTION	MFG #	PART #	
Drive Pin & Coupling	500204	444176	58.36



TRAILER

- tires & wheels
- axles, hubs & springs
- tongue accessories
- hitches
- electrical
- brake parts
- trailer hardware
- locks & pins
- towing & loading
- tie downs
- tools
- chemicals

SWIVEL JACK (1000 lbs)

- Retaining swivel ring
- Zinc finish for dependable long life
- Fits up to 3" x 5" tongue frames
- Includes all mounting hardware
- Rugged 6" poly wheel
- Heavy duty swivel retaining ring with multiple locking positions
- Spring-loaded locking pin for safe secure operation
- Easy-service gear box
- Grease fitting for easy lubrication
- 1 year warranty
- Boxed for display



PART #	Top A	Retracted Length B	Extended Length C
FT800	10-1/2"	13"	23"

REPLACEMENT PARTS

DESCRIPTION	MFG #	PART #	
Wheel Kit	6811S00	FT502	26.61
Handle Kit	0933301S00	FT5027	24.38

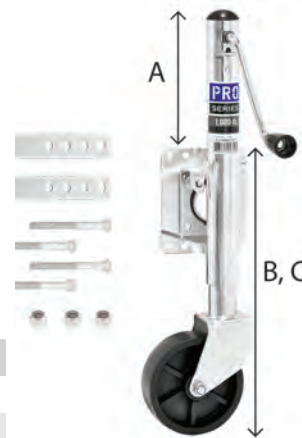

MARINE/RECREATIONAL SWIVEL JACK (1200 lbs)

- Retaining swivel ring operation
- Quickly and easily installed
- Complete with replaceable 6" poly wheel
- Fits all trailer tongues up to 3 x 5"
- Zinc plated
- 5 year warranty
- Boxed for display



PART #	Top A	Retracted Length B	Extended Length C
FT503	11"	13"	23"

REPLACEMENT PARTS

DESCRIPTION	MFG #	PART #	
Wheel Kit	6811S00	FT502	26.61
Handle Kit	0933301S00	FT5027	24.38



DELUXE JACK (1500 lbs) WITH BOLT THROUGH SWIVEL ATTACHMENT

- Heavy duty swivel mechanism combines ease of operation with superior load carrying capabilities
- Operates in seconds with new pull-pin swivel release
- 1:1 sidewind gear ratio provides fast, easy jack operation
- Heavy duty 2.25" zinc plated steel tubing
- Quick and easy installation
- 8" reinforced poly wheel (replaceable)
- Fits trailer tongues up to 3" x 5" x 5"
- Boxed for display



PART #	Top A	Retracted Length B	Extended Length C
FT505	13"	12.75"	23"

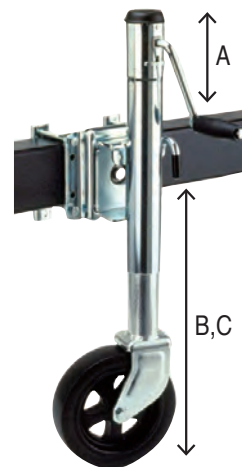

DUAL WHEEL HEAVY DUTY JACK (1500 lbs) WITH BOLT THROUGH SWIVEL ATTACHMENT

- Heavy duty swivel mechanism combines ease of operation with superior load carrying capabilities
- 1,500 lb. capacity heavy duty dual wheel swivel jack features two (2) 6" wide profile wheels for maximum ground support
- Ideal for use on soft surfaces
- Welded independent castoring under heavy loads
- Quick and easy trailer installation
- Fits trailer tongues up to 3" x 5"
- Zinc plated
- Boxed for display



PART #	Top A	Retracted Length B	Extended Length C
FT125	12"	12.75"	23"

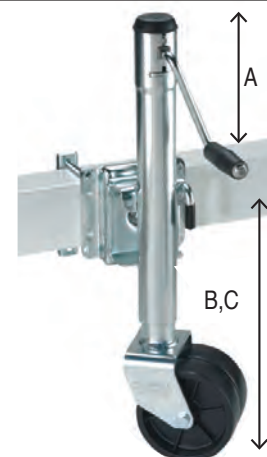

- tires & wheels
- axles, hubs & springs
- tongue accessories
- hitches
- electrical
- brake parts
- trailer hardware
- locks & pins
- towing & loading
- tie downs
- tools
- chemicals

TRAILER

- tires & wheels
- axles, hubs & springs
- tongue accessories
- hitches
- electrical
- brake parts
- trailer hardware
- locks & pins
- towing & loading
- tie downs
- tools
- chemicals

SWING AWAY MARINE JACK

- 1000 lb lift capacity
- 10" travel
- Sidewind
- 14-3/4" retracted, 24-3/4" extended
- 6" wheel
- Bolt-on mounting bracket fits up to 3" x 5" trailer frame
- Easy installation; all mounting hardware included
- Zinc finish
- Full color retail package



MFG #	PART #
0091610	BY1610 106.72

ELECTRIC JACK

- 12 volt DC powered with manual crank over-ride
- 3,500 lbs lifting capacity (assists hitch ball release)
- Hardened steel gears
- Over-sized, 5 1/4" diameter foot pad prevents divots
- Zinc plated foot is adjustable on 1 1/2" centers (detachable)
- Weather sealed switch
- 26 1/2" overall height
- Retail packaged



Universal bolt-pattern for a-frame hitch



Manual crank over-ride included



MFG #	PART #
0093500	BY3500 273.04

TUBE MOUNT SWIVEL JACK

Tube mount swivel jacks offer the convenience of a swivel mechanism with the durability needed for commercial, agricultural, and industrial markets



MFG #	PART #
0091205	BY91205 69.50
0091215	BY91215 76.94
0091220	BY91220 76.14

REPLACEMENT PARTS

DESCRIPTION	MFG #	PART #
Pin Kit For Mount	00912TS	BY912TS 5.94

TRAILER

A-FRAME JACK

- A-frame jacks are engineered to meet heavy-duty demands of today's rental, RV, industrial, agricultural, commercial and marine trailers
- High strength triangular steel mounting brackets provide easy bolt-on or weld-on mounting and ensure years of trouble free service
- Both jacks are sold with the foot base



- tires & wheels
- axles, hubs & springs
- tongue accessories**
- hitches
- electrical
- brake parts
- trailer hardware
- locks & pins
- towing & loading
- tie downs
- tools
- chemicals

DESCRIPTION	MFG #	PART #	
2000# A-Frame Jack w/Support Foot	0091260	BY91260	89.95
2000# A-Frame Jack Only	0091261	BY91261	62.02
5000# A-Frame Jack w//Support Foot	0091265	BY91265	89.95

REPLACEMENT PARTS

DESCRIPTION	MFG #	PART #	
Foot Base Only	0091269	BY91269	12.38

2 1/2" SQUARE JACK TOP WIND

- Fabricated from high strength, telescoping steel tubing
- Corrosion-resistant finish and high efficiency cranking mechanism give a long lasting, easy operating jack
- 7000# capacity
- 26" travel
- Retracts 22.38"
- Extends 38"



REPLACEMENT PARTS

MFG #	PART #	DESCRIPTION	MFG #	PART #	
0091310	BY91310	121.58	Handle Assembly	3005222A	BY5522 7.86

2 1/2" SQUARE JACK SIDE WIND

- Fabricated from high strength, telescoping steel tubing
- Corrosion-resistant finish and high efficiency
- Cranking mechanism give a long lasting, easy operating jack
- 7000# capacity
- 26" travel
- Retracts 25.75"
- Extends 41"



REPLACEMENT PARTS

MFG #	PART #	DESCRIPTION	MFG #	PART #	
0091340	BY91340	134.02	Handle Assembly	3005525A	BY5525 10.44
			Cap With Screw	3005526	BY5526 3.45

TRAILER

- tires & wheels
- axles, hubs & springs
- tongue accessories
- hitches
- electrical
- brake parts
- trailer hardware
- locks & pins
- towing & loading
- tie downs
- tools
- chemicals

TRAILER

POWERED A-FRAME JACK

Tough & Trusted BULLDOG presents a Powered Jack with all the capacity and features you want.

- Positions quickly with 22" of total travel
- 3500 lb. lift capacity
- Integrated gearbox and motor
- Drop leg
- Deploys and hooks up easily at night with onboard LED courtesy light, angled to illuminate coupler
- Works in case of power loss with emergency manual override capability, easily accessible from the top, crank included
- Lasts for years with industry-leading BULLDOG performance, known worldwide for unmatched strength, durability, and side load capacity
- Retains like-new appearance with corrosion-resistant surfaces
- Limited 5-year warranty

DESCRIPTION	MFG #	PART #	
3,500 lbs. Powered A-Frame Jack, Black Case	500187	444167	497.16
3,500 lbs. Powered A-Frame Jack, White Case	500188	444168	497.16

REPLACEMENT PARTS / ACCESSORIES

DESCRIPTION	MFG #	PART #	
Black Cover w/Mounting Screws	500305	444173	112.13
White Cover w/Mounting Screws	500306	444174	104.56
Manual Override Cover	500201	444170	10.64
LED Light Assembly	500202	444171	36.19
Manual Override Crank	500203	444172	44.97
Removable Disc Foot w/Snapper Pin	500190	444169	60.98



WELD-ON RETAINING RING SWIVEL

TOP WIND

- 1/2" diameter plunger pin with base plate
- Includes bracket mount
- Mounting plate and snap ring are sold separately

MFG #	CAPACITY	TRAVEL	RETRACTED	EXTENDED	CLEARANCE	PART #	
1514010117	2000#	10"	11.00"	21.00"	4.00"	FT540	104.68
1514210117	2000#	15"	14.50"	29.50"	10.00"	FT542	142.22

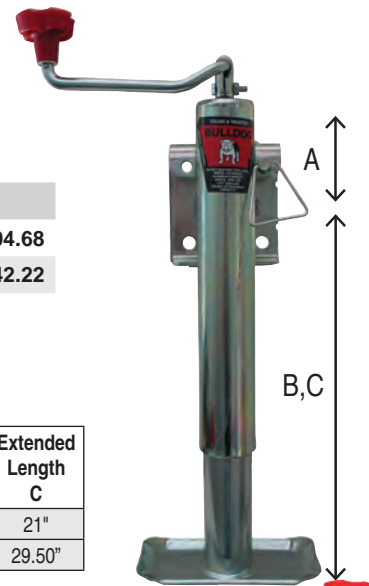

REPLACEMENT PARTS / ACCESSORIES

DESCRIPTION	MFG #	PART #	
Snap Ring	P9086-00	FT548	2.57
Mounting Bracket	P20520-00	FT549	9.37
Caster Wheel 2000-5000#	500245	FT554	54.50
Replacement Wheel	6811S00	FT502	26.61
Replacement Foot Pad	F2000 010	FT560	44.71

PART #	Top A	Retracted Length B	Extended Length C
FT540	4"	11"	21"
FT542	10"	14.50"	29.50"

BOLT-ON RETAINING RING SWIVEL

TOP WIND

- Assembled with mounting bracket
- 1/2" diameter plunger pin
- No base
- Fits tongue up to 3" x3"

MFG #	CAPACITY	TRAVEL	RETRACTED	EXTENDED	CLEARANCE	PART #	
1514430117	2000#	10"	11.00"	21.00"	4.00"	FT514	117.38

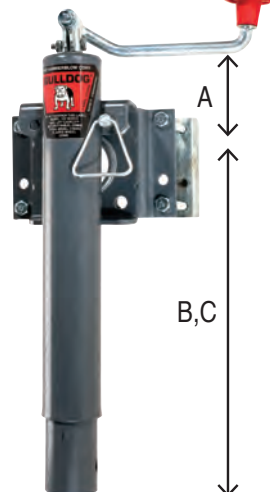

REPLACEMENT PARTS / ACCESSORIES

DESCRIPTION	MFG #	PART #	
Caster Wheel 2000-5000#	500245	FT554	54.50
Replacement Wheel	6811S00	FT502	26.61
Replacement Foot Pad	F2000 010	FT560	44.71

PART #	Top A	Retracted Length B	Extended Length C
FT514	4"	11"	21"

BULLDOG SQUARE JACK 5000# Support Capacity • 3000# Lift Capacity • Top Wind

A-FRAME

- Fixed leg less base
- Drop leg offers 13.50" additional adjustment

CAPACITY	TRAVEL	RETRACTED	EXTENDED	CLEARANCE
5000#	15"	7.40"	22.40"	14.70"

MFG #	PART #
195321	FT530 123.82



- tires & wheels
- axles, hubs & springs
- tongue accessories
- hitches
- electrical
- brake parts
- trailer hardware
- locks & pins
- towing & loading
- tie downs
- tools
- chemicals

BULLDOG SQUARE JACKS

Tubular Swivel Mount • Round • 5000# Support Capacity • 3000# Lift Capacity

TOP WIND

- Fixed leg with base (pipe mount)
- Includes male mating mount, pin, and chain

CAPACITY	TRAVEL	RETRACTED	EXTENDED	CLEARANCE
5000#	15"	15.20"	30.20"	7.00"

MFG #	PART #
195306	FT536 141.51

SIDE WIND

- Fixed leg with base (pipe mount)
- Includes male mating mount, pin, and chain

CAPACITY	TRAVEL	RETRACTED	EXTENDED	CLEARANCE
5000#	15"	15.10"	30.10"	9.25"

MFG #	PART #
195356	FT537 155.02



BULLDOG SQUARE JACK

Tubular Swivel Mount • 8000# Support Capacity • 5000# Lift Capacity

TOP WIND

- Fixed leg with heavy duty base
- Painted outer tube
- Zinc plated inner tube
- Includes male mating mount, pin, and chain

CAPACITY	TRAVEL	RETRACTED	EXTENDED	CLEARANCE
8000#	10"	11.41"	21.41"	4.25"

MFG #	PART #
190705	FT532 177.31



ROUND JACK - TUBULAR SWIVEL (Weld on)

Painted outer tube • Zinc plated inner tube • Easy cranking

TOP WIND

Male mating mount included • 9/16" pin • Includes foot pad

MFG #	CAPACITY	TRAVEL	RETRACTED	EXTENDED	CLEARANCE	PART #
1584510117	2000#	10"	11.00"	21.00"	4.00"	FT8451 129.63

PART #	Top A	Retracted Length B	Extended Length C
FT8451	4"	11"	21"
FT8150	6.40"	11"	21"

SIDE WIND

Female mating mount included • 5/8" pin • Includes foot pad

MFG #	CAPACITY	TRAVEL	RETRACTED	EXTENDED	CLEARANCE	PART #
198150	7000#	10"	11.00"	21.00"	6.40"	FT8150 183.74

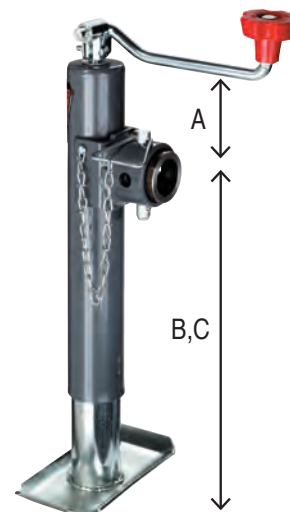

TRAILER

FAST SAME DAY SHIPPING

TONGUE ACCESSORIES

- tires & wheels
- axles, hubs & springs
- tongue accessories
- hitches
- electrical
- brake parts
- trailer hardware
- locks & pins
- towing & loading
- tie downs
- tools
- chemicals

A-FRAME JACKS (Weld-on or Bolt-on)

TOP WIND

- Extra thick A-frame mounting bracket
- Painted outer and inner tubes
- 3 sizes
- Less wheel or base

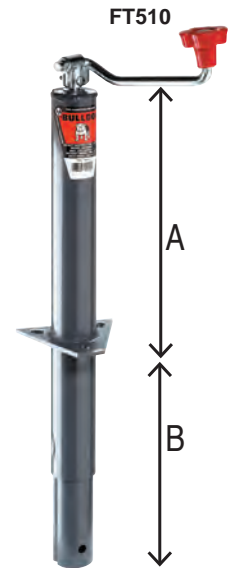

MFG #	CAPACITY	TRAVEL	RETRACTED	EXTENDED	CLEARANCE	PART #	
1550220117	2000#	15"	8.20"	23.20"	12.20"	FT510	91.49
1750290317	5000#	15"	10.80"	25.80"	-----	FT525	76.68

REPLACEMENT PARTS / ACCESSORIES

DESCRIPTION	MFG #	PART #	
Caster Wheel 2000-5000#	500245	FT554	54.50
Replacement Wheel	6811S00	FT502	26.61
Replacement Foot Pad	F2000 010	FT560	44.71

PART #	Top A	Retracted Length B	Extended Length C
FT510	12.20"	8.20"	23.20"
FT512	10.20"	10.30"	25.30"
FT525	-----	10.80"	25.80"

A-FRAME JACKS (Weld-on or Bolt-on)

Easy cranking - 8 turns per inch

SIDE WIND

- Painted outer and inner tubes
- 3 sizes
- Less wheel or base

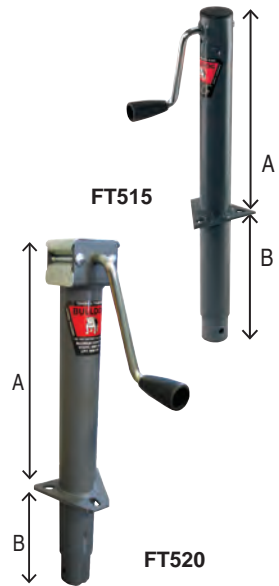

MFG #	CAPACITY	TRAVEL	RETRACTED	EXTENDED	CLEARANCE	PART #	
155157	2000#	13"	8.60"	21.50"	13.00"	FT515	106.26
1550100317	3000#	13"	7.00"	20.00"	14.50"	FT520	93.33

REPLACEMENT PARTS / ACCESSORIES

DESCRIPTION	MFG #	PART #	
Caster Wheel 2000-5000#	500245	FT554	54.50
Replacement Wheel	6811S00	FT502	26.61
Replacement Foot Pad	F2000 010	FT560	44.71

PART #	Top A	Retracted Length B	Extended Length C
FT515	13"	8.60"	21.50"
FT520	14.50"	7"	20"

CASTER WHEEL MUST BE PURCHASED SEPARATELY FOR BULLDOG JACKS

BULLDOG REPLACEMENT PART KITS - BULK

CASTER WHEEL ASSEMBLY

- 6" x 2" reinforced poly wheel for easy rolling and ground support
- Wheel is replaceable
- Fits 2" jacks
- 1200# load

PART #	MFG #	U/M
FT555	45.99	CE5550301 EA



6" POLY WHEEL KIT

Includes wheel, spacer, bolt, nut

PART #	MFG #	U/M
FT502	26.61	6811S00 EA

BOTTOM SUPPORT PLATE

- For our A-Frame jacks
- A little extra support

PART #	MFG #	U/M
FT550	5.29	SPB500300 EA



FOOT PAD

- 4" x 6"
- 2.1" tall
- Zinc plated

PART #	MFG #	U/M
FT558	21.06	185640301 EA

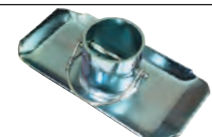

TRAILER



BULLDOG REPLACEMENT PART KITS - CLAM SHELL PACKAGED

Get the attention of your customers with attractive, colorfully packaged Bulldog genuine replacement part kits in clear plastic clam shells. Engineered for maximum strength and durability, a display of these top selling genuine Bulldog replacement parts is a good way to increase overall sales. Consumers know the best way to maintain the integrity of their Bulldog products is to always use genuine replacement parts manufactured by the most trusted name in the industry.



SIDE WIND CRANK KITS

MFG #	DESCRIPTION	U/M	PART #
500256	5.80" RADIUS ASSEMBLY AND GEAR KIT 2000#	KIT	FT561 36.27
500105	6.50" RADIUS ASSEMBLY W/BLACK KNOB 1000#-5000#	KIT	FT562 26.87
500171	8.50" RADIUS ASSEMBLY W/BLACK KNOB 7000#	KIT	FT563 32.87

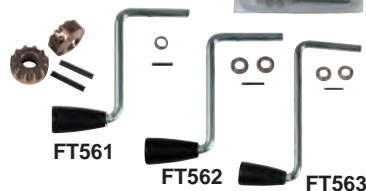

TOP WIND CRANK KIT

MFG #	DESCRIPTION	U/M	PART #
500180	6.75" RADIUS ASSEMBLY/RED KNOB 1000#	KIT	FT564 22.50



KNOB KITS

MFG #	DESCRIPTION	U/M	PART #
500248	BLACK KNOB TEAR DROP 1000#-5000#	KIT	FT566 11.88
500246	RED KNOB KIT 2000#-5000#	KIT	FT567 17.69



PIN KITS

MFG #	DESCRIPTION	U/M	PART #
500243	9/16" PULL PIN 3.5" LONG W/CHAIN AND DRIVE SCREW 1000# TOP WIND ONLY	KIT	FT577 14.15
500231	5/8" PULL PIN 3.5" LONG W/ CHAIN AND DRIVE SCREW 5000# TOP WIND ONLY	KIT	FT578 12.99
500232	5/8" PULL PIN 4.25" LONG W/CHAIN AND COTTER PIN	KIT	FT579 15.96

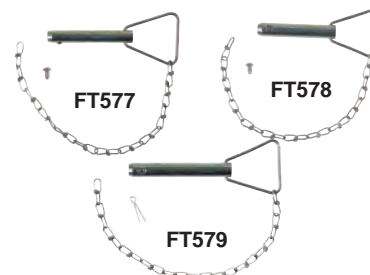

BEARING KITS

MFG #	DESCRIPTION	U/M	PART #
500223	THRUST BEARING KIT FOR 5000# CAPACITY MODELS	KIT	FT572 16.86
500224	THRUST BEARING KIT FOR 8000# CAPACITY MODELS	KIT	FT573 19.98



BEARING KITS

MFG #	DESCRIPTION	U/M	PART #
500106	SIDE WIND GEAR KIT FOR UP TO AND INCLUDING 5000# MODELS	KIT	FT575 17.13
500156	SIDE WIND GEAR KIT FOR 8000# CAPACITY MODELS	KIT	FT576 35.40



WHEEL KIT

MFG #	DESCRIPTION	U/M	PART #
500245	CASTER ASSEMBLY WITH POLY WHEEL 800#	KIT	FT554 54.50



BASE PLATE KIT

MFG #	DESCRIPTION	U/M	PART #
500244	REMOVABLE DISC FOOT W/ PIN 2.1" TALL FITS JACKS W/ 2" TUBE	KIT	FT556 30.15



- tires & wheels
- axles, hubs & springs
- tongue accessories
- hitches
- electrical
- brake parts
- trailer hardware
- locks & pins
- towing & loading
- tie downs
- tools
- chemicals

TRAILER

BUYERS TOOLBOXES

POLYMER UNDERBODY TOOLBOX

- Height-18" x Depth-18" x Width-36"
- Weight-24lbs
- Constructed of molded high-density ribbed polyethylene
- D-bulb door seal protects from the elements
- Stainless steel recessed locking T-handle 3-point latch w/roller (includes 2 keys)
- Strong double-wall door
- 1/4" stainless steel full width hinge pin



MFG #	PART #	
1717105	BY1717	393.90

OPTIONAL MOUNTING BRACKETS

- 15" x 14"
- 11 lbs
- Constructed of heavy duty 2" C-channel A-36 steel
- Black powder-coated for corrosion resistance
- Channel fits inside toolbox ribs
- Pre-drilled 7/16" mounting holes (hardware not included)
- Sold boxed



MFG #	PART #	
1701000	BY1701	111.30

POLYMER TRAILER TONGUE BOX

- Height-18" x Depth-19" x Width-36" x 18"
- Weight-21lbs
- Polymer-constructed of molded high density polyethylene
- This toolbox offers an easy way to add secure storage to your trailer



MFG #	PART #	
1701680	BY1680	205.30

ALL-PURPOSE POLY CHEST

- Large capacity, low profile chest mounts to floors of pickup beds, trailers, garages, etc.
- Constructed of heavy-duty, impact resistant polyethylene
- Double panel, top-opening lid w/zinc hasp
- Stainless steel hinge
- Built-in carrying handles
- Overlapping lid design seals out weather



MFG #	PART #	
1712230	BY2230	162.60

DUAL POLY STEP • 2 STEPS, BLACK

- Utility step
- Recycled hi-density black polyethylene
- UV stable
- Built-in handle provides easy lifting
- Stackable for storage/shipment
- Non-skid step surface
- Lightweight (14.6 lbs)
- Great for industrial, agricultural and home use
- Wide grip footprint reduces slippage

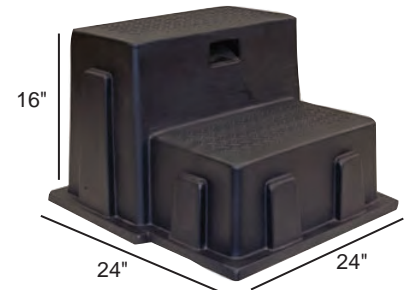

MFG #	PART #	
3013658	BY3658	94.54

FOLDING FOOT/GRAB STEP

- Investment cast
- E-coated finish
- 4" W x 2" D
- Sold each (bulk)



MFG #	PART #	
B2797BPC	BY2797	13.95

TRAILER

BUYERS STRAIGHT TONGUE COUPLERS



PART #	MFG #	BALL SIZE	CHANNEL SIZE	CLASS	GTW	UM
BY91050	16.88	0091050	1-7/8"	2"	1	2000# EA
BY91052	19.16	0091052	1-7/8"	2-1/2"	1	2000# EA
BY91055	18.34	0091055	1-7/8"	3"	2	2000# EA
BY91058	27.10	0091058	2"	2"	2	3500# EA
BY91060	23.68	0091060	2"	2-1/2"	2	3500# EA
BY91065	26.42	0091065	2"	3"	2	3500# EA

- 2", 2 1/2", or 3" channel
- Can be bolted or welded to trailer frame
- Recreational or utility use
- Pad lock hole provided for trailer security



FULTON STRAIGHT TONGUE COUPLERS



PART #	MFG #	BALL SIZE	CHANNEL SIZE	CLASS	GTW	COLOR	UM
FT310	35.15	11200-0201*	1-7/8"	2"	I	2000# ZINC	EA
FT210	22.44	11200-0217	1-7/8"	2"	I	2000# PRIMED	EA
FT311	35.15	11250-0201*	1-7/8"	2-1/2"	I	2000# ZINC	EA
FT211	15.63	11250-0217	1-7/8"	2-1/2"	I	2000# PRIMED	EA
FT312	35.15	11300-0201*	1-7/8"	3"	I	2000# ZINC	EA
FT212	15.63	11300-0217*	1-7/8"	3"	I	2000# PRIMED	EA
FT313	39.83	22200-0201*	2"	2"	II	3500# ZINC	EA
FT213	29.90	22200-0217*	2"	2"	II	3500# PRIMED	EA
FT315	39.83	22250-0101	2"	2-1/2"	II	3500# ZINC	EA
FT215	29.90	22250-0217*	2"	2-1/2"	II	3500# PRIMED	EA
FT314	39.83	22300-0101*	2"	3"	II	3500# ZINC	EA
FT214	29.90	22300-0217*	2"	3"	II	3500# PRIMED	EA
FT316	52.70	34300-0301	2"	3"	III	5000# ZINC	EA
FT216	50.76	34300-0217*	2"	3"	III	5000# PRIMED	EA

- The most popular latching mechanism ever designed is now available in a complete line of FAS-LOC couplers from Fulton
- Available in 1-7/8" and 2". Class I, II and III straight tongue
- Proven Fulton FAS-LOC locking lever hooks up quickly and easily to tow vehicle
- Heavy duty safety latch designed to prevent accidental uncoupling
- Padlock hole provided for trailer security



BUYERS HEAVY DUTY STRAIGHT TONGUE COUPLERS

- 2 sizes
- Automatic engage latch
- Easy one hand operation
- 3" channel welded to coupler
- Cast steel coupler
- Zinc and clear chromatic finish

PART #	MFG #	BALL SIZE	CHANNEL SIZE	CLASS	GTW	UM
BY91560	197.52	0091560	2"	3"	IV	10,000# EA
BY91562	194.76	0091562	2"	3"	IV	15,000# EA



BUYERS A-FRAME COUPLERS



- 2 sizes
- 50° frame design
- Pre-drilled for round jack mounting

PART #	MFG #	BALL SIZE	FRAME DEGREE	CLASS	GTW	UM
BY91091	49.08	0091091	2"	50	III	5000# EA
BY91097	57.00	0091097	2-5/16"	50	IV	10,000# EA



tires & wheels

axles, hubs & springs

tongue accessories

hitches

electrical

brake parts

trailer hardware

locks & pins

towing & loading

tie downs

tools

chemicals

TRAILER

TONGUE ACCESSORIES

- tires & wheels
- axles, hubs & springs
- tongue accessories
- hitches
- electrical
- brake parts
- trailer hardware
- locks & pins
- towing & loading
- tie downs
- tools
- chemicals

FULTON A-FRAME COUPLERS

- Weld on
- Fits 50° frames
- Ductile iron ball clamp
- Stainless steel spring & pivot pin
- Easy latch mechanism
- Positive open latch feature



PART #	MFG #	BALL SIZE	FRAME DEGREE	CLASS	GTW	UM
FT252	32.63	E33305-0303	2"	50	III	5000# EA
FT254	85.86	44305R0317	2-5/16"	50	IV	10,000# EA

BUYERS A-FRAME CAST COUPLERS

- Heavy-duty cast steel coupler, with steel a-frame
- Auto-engage latch
- Easy one-hand operation
- Durable, black powdercoat finish
- Can be pinned open for ease of coupling
- 50° a-frame
- Round jack mount
- 18" overall length



PART #	MFG #	BALL SIZE	FRAME DEGREE	CLASS	GTW	UM
BY91595	256.84	0091595	2-5/16"	50	-	15,000# EA

BUYERS ADJUSTABLE CHANNEL MOUNT ONLY

- 3 position / 5 position
- To be used with **BY91005** cast coupler

PART #	MFG #	POSITIONS	WELDED GUSSETS	UM
BY8978	33.46	B8978	3	NO
BY8979	62.32	B8979	5	YES



BUYERS ADJUSTABLE COUPLER REPAIR KIT

- Adjustable repair kit for coupler # **BY91015** (above)
- Sold separately

PART #	MFG #	SIZE	GTW	UM
BY91015	35.60	0091015	1-7/8"-2"	7000# EA



FULTON HANDI GRIP COUPLER HANDLE

- Display packaged each
- Allows for easy trailer positioning
- Fits all 1-7/8" & 2" couplers
- Easy bolt on installation
- Non-corrosive finish, comfort grip handle



PART #	MFG #	UM
FT200	23.42	CH0701 EA



FULTON FOLD-AWAY BOLT-ON HINGE KITS

- Converts standard trailer tongues into fold-away configurations while preserving the existing coupler
- Delivers strength at the pivot point with precisely machined heavy duty hinges made from die cast steel
- Easy to install bolt-on application with complete instruction manual
- Mount Fold-Away products to trailer tongues made only of steel
- Includes all mounting hardware



PART #	MFG #	DESCRIPTION
444376	181.53	HDPB230101 FULTON FOLD-AWAY BOLT-ON HINGE KIT, 2" X 3" TRAILER BEAM, ZINC FINISH, RATING 5,000 LBS.
444377	209.14	HDPB330101 FULTON FOLD-AWAY BOLT-ON HINGE KIT, 3" X 3" TRAILER BEAM, ZINC FINISH, RATING 5,000 LBS.
444379	258.96	HDPB350101 FULTON FOLD-AWAY BOLT-ON HINGE KIT, 3" X 5" TRAILER BEAM, ZINC FINISH, RATING 9,000 LBS.

TRAILER



AUTOMATIC
DISTRIBUTORS

TRAILER CATALOG

HITCHES

HITCHES

- tires & wheels
- axles, hubs & springs
- tongue accessories
- hitches**
- electrical
- brake parts
- trailer hardware
- locks & pins
- towing & loading
- tie downs
- tools
- chemicals

TRAILER

TRIMAX TOW BALLS

Weight Rating 8,000 lbs



PART #	MFG #	DESCRIPTION	U/M
348047	19.99 TBC2	2" Tow Ball Chrome	EA
348048	22.99 TBC2516	2-5/16" Tow Ball Chrome	EA
348049	41.99 TDBC22516	2" & 2-5/16" Double Tow Ball Chrome	EA
348050	75.99 TBSX2	2" Tow Ball Stainless Steel	EA
348051	89.99 TBSX2516	2-5/16" Tow Ball Stainless Steel	EA



BUYERS TRAILER HITCH BALLS

Buyers offers a complete line of the most popular hitch balls. Available in stainless steel, chrome, or plain finish. These hitch balls combine rugged performance with good looks.

PART #	MFG #	BALL DIA.	SHANK DIA.	SHANK LENGTH	MAX GTW	COLOR	PKG/BULK
BY2015	14.60 1802015	1-7/8"	3/4"	2-1/8"	3500#	CHROME	PKG
BY2020	17.34 1802020	1-7/8"	1"	2-1/8"	5000#	CHROME	PKG
BY2010	14.40 1802010	2"	3/4"	2-1/8"	3500#	CHROME	PKG
BY2005	16.08 1802005	2"	1"	2-1/8"	5000#	CHROME	PKG
BY2007	20.18 1802007	2"	1"	2-3/4"	10,000#	CHROME	PKG
BY2026	20.68 1802026	2-5/16"	1"	2-1/8"	7500#	CHROME	PKG
BY2027	25.10 1802027	2-5/16"	1"	2-3/4"	10,000#	CHROME	PKG
BY2025	26.40 1802025	2-5/16"	1-1/4"	2-3/4"	10,000#	CHROME	PKG
BY2173	16.95 1802173	2-5/16"	1-1/4"	2-1/2"+1" RISE	7000#	CHROME	BULK
BY2175	26.48 1802175	2-5/16"	1-1/4"	2-1/2"+2" RISE	7000#	CHROME	BULK
BY2050	47.34 1802050	2-5/16"	1-1/4"	2-3/4"	30,000#	BLACK	BULK
BY2056	47.84 1802056	2-5/16"	1-1/2"	2-3/4"+1" RISE	30,000#	BLACK	BULK
BY2061	53.42 1802061	2-5/16"	1-1/2"	2-3/4"+2" RISE	30,000#	BLACK	BULK

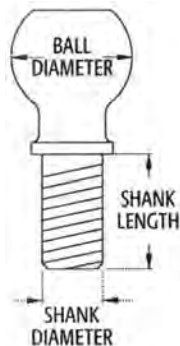

TOW READY HITCH BALLS

Chrome external thread balls fit right every time and are selected to match:
Size of coupler, Gross trailer weight, Thickness of platform, Hole size.



BALL DIA. (A)	SHANK DIA. (B)	SHANK LENGTH (C)	DRAWBAR		MAX GROSS TRAILER WGT. (GTW) #	PKG/ BULK	ZINC PART #	CHROME PART #	STAINLESS PART #			
			THICKNESS RANGE									
1-7/8"	3/4"	1-1/2"	3/8"-5/8"		2000#	BULK	444126	10.48	DT5012	14.84	----	
1-7/8"	3/4"	1-1/2"	3/8"-5/8"		2000#	PKG	444137	12.46	DT3572	17.56	----	
1-7/8"	3/4"	2-3/8"	3/8"-1-3/8"		2000#	BULK	444127	13.15	DT5022	18.47	----	
1-7/8"	3/4"	2-3/8"	3/8"-1-3/8"		2000#	PKG	----		DT3574	21.14	----	
1-7/8"	3/4"	3-3/8"	3/8"-1-3/8"		2000#	BULK	----		DT4102	24.80	----	
1-7/8"	1"	2-1/8"	3/8"-3/4"		2000#	BULK	444128	12.22	DT5032	17.25	----	
1-7/8"	1"	2-1/8"	3/8"-3/4"		2000#	PKG	444138	14.23	DT3584	19.89	444149	64.33
1-7/8"	1"	3-3/8"	3/8"-2-1/8"		2000#	BULK	444129	13.04	DT4122	13.68	----	
2"	3/4"	1-1/2"	3/8"-5/8"		3500#	BULK	----		DT5062	14.84	----	
2"	3/4"	2-3/8"	3/8"-1-3/8"		3500#	BULK	444131	13.15	DT5072	18.47	----	
2"	1"	2-1/8"	3/8"-3/4"		6000#	PKG	----		----	444150	72.10	
2"	1"	2-1/8"	3/8"-3/4"		7500#	PKG	----		444079	20.74	----	
2"	1-1/4"	2-3/4"	3/8"-1"		8000#	PKG	----		444146	32.81	----	
2-5/16"	1"	2-1/8"	3/8"-3/4"		6000#	PKG	----		----	444151	82.16	
2-5/16"	1"	2-1/8"	3/8"-3/4"		7500#	PKG	444141	19.28	444147	27.51	----	
2-5/16"	1-1/4"	2-3/4"	3/8"-1"		12,000#	BULK	----		DT5092	29.67	----	
2-5/16"	1-1/4"	2-3/4"	3/8"-1"		14,000#	BULK	----		444143	38.95	----	
2-5/16"	1-1/4"	2-3/4"	3/8"-1"		20,000#	BULK	----		444144	42.84	----	
50MM	3/4"	1-1/2"	3/8"-5/8"		3500#	BULK	----		444145	17.31	----	

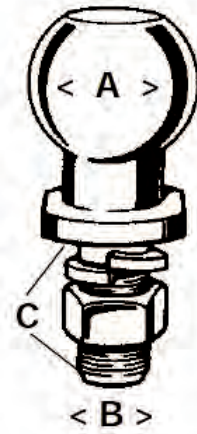

- tires & wheels
- axles, hubs & springs
- tongue accessories
- hitches**
- electrical
- brake parts
- trailer hardware
- locks & pins
- towing & loading
- tie downs
- tools
- chemicals

INTERCHANGEABLE HITCH BALL SYSTEMS

Designed to accommodate towing multiple trailers with ease, Tow Ready Interchangeable Hitch Ball System allows you to change hitch ball sizes in seconds without any tools.

- Innovative quick release changes balls in seconds
- Rated capacities up to 5,000 lbs.
- Durable heat treated shank
- New positive latch design
- No special tools required



PART #	MFG #	DESCRIPTION	FINISH
444117	60.30	63801 3/4" Shank, 1-7/8" & 2" Balls, 5,000 lbs. Rating	Chrome
444118	91.61	63802 1" Shank, 1-7/8" & 2" Balls, 8,000 lbs. Rating	Chrome
444119	67.47	63804 1" Shank, 2" & 2-5/16" Balls, 8,000 lbs. Rating	Chrome
444120	116.15	63803 1" Shank, 1-7/8", 2" & 2-5/16" Balls, 8,000 lbs. Rating	Chrome



TRAILER

REPLACEMENT INTERCHANGEABLE HITCH BALLS

PART #	MFG #	DESCRIPTION	FINISH
444121	19.89	63805 1-7/8" Replacement Ball for 3/4" & 1" Shanks	Chrome
444122	22.14	63806 2" Replacement Ball for 3/4" & 1" Shanks	Chrome
444123	33.24	63807 2-5/16" Replacement Ball for 1" Shank	Chrome
444124	42.27	63808 3/4" Replacement Shank	Chrome
444125	53.50	63809 1" Replacement Shank	Chrome



FAST SAME DAY SHIPPING

HITCHES

- tires & wheels
- axles, hubs & springs
- tongue accessories
- hitches**
- electrical
- brake parts
- trailer hardware
- locks & pins
- towing & loading
- tie downs
- tools
- chemicals

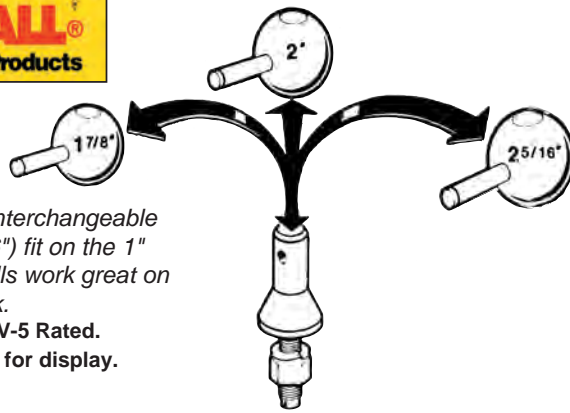

No more wrenches - three interchangeable balls (1-7/8", 2" and 2-5/16") fit on the 1" shank. The 1-7/8" and 2" balls work great on the 3/4" shank.

SAE-I684-E Approved - V-5 Rated.
All units shrink packaged for display.

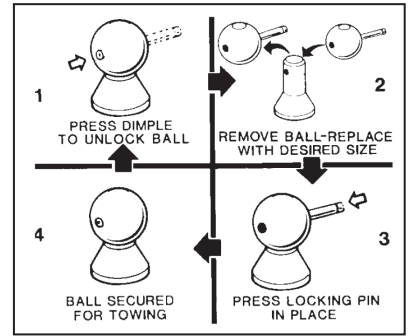

Your answer to multi-need trailer connections.

CHROME SETS

PART #	MFG #	BALL SIZE	SHANK SIZE	SHANK LENGTH	U/M
CB4800	48.95	800B	1-7/8", 2"	3/4"	REGULAR SET
CB4900	72.95	900B	1-7/8", 2", 2-5/16"	1"	REGULAR SET
CB4901	46.95	901B	1-7/8", 2"	1"	REGULAR SET
CB4904	51.95	904B	2", 2-5/16"	1"	REGULAR SET
CB4105	51.95	105LB	1-7/8", 2"	1"	LONG SET

SOLD AS COMPLETE KITS

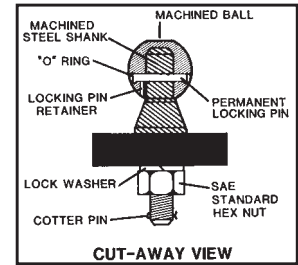

STAINLESS STEEL SETS

PART #	MFG #	BALL SIZE	SHANK SIZE	SHANK LENGTH	U/M
CB4802	87.95	802B	1-7/8", 2"	3/4"	REGULAR SET
CB4903	101.95	903B	1-7/8", 2"	1"	REGULAR SET
CB4902	145.95	902B	1-7/8", 2", 2-5/16"	1"	REGULAR SET
CB4906	116.95	906B	2", 2-5/16"	1"	REGULAR SET



TRAILER

BALL ONLY

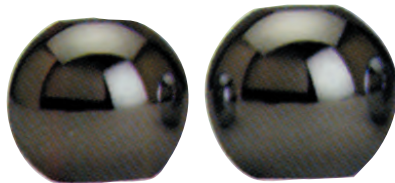

PART #	MFG #	SIZE	COLOR	U/M
CB4300	14.95	300B	1-7/8"	CHROME EA
CB4301	30.95	301B	1-7/8"	STAINLESS EA
CB4400	17.95	400B	2"	CHROME EA
CB4401	32.95	401B	2"	STAINLESS EA
CB4600*	21.95	600B	2-5/16"	CHROME EA
CB4601*	39.95	601B	2-5/16"	STAINLESS EA

*WILL NOT WORK ON THE 3/4" SHANK

SHANK ONLY

PART #	MFG #	SIZE	LENGTH	U/M
CB4101	18.95	101B	3/4"	LONG EA
CB4102	21.95	102B	1"	REGULAR EA
CB4104	27.95	105B	1"	LONG EA



SHANK COVERS

PART #	MFG #	COLOR	U/M
CB4002	2.95	005B	BLACK EA

SHANK STORAGE

PART #	MFG #	DESCRIPTION	U/M
CB4004	14.95	004B	3 BALL STORAGE BOX W/ COVER EA



DRAWBAR KITS

- Boxed includes drawbar, pin and clip
- Black powder coat finish over A-Coat
- Fits 1-1/4" square receiver tube opening



PART #	MFG #	DESCRIPTION	WEIGHT CARRYING
444152	48.40	3590 Class I 1-1/4" Drawbar Kit, Drawbar (2000 lbs. w/3/4" Ball Hole 6-5/8" Length x 5/8" Rise), Pin and Clip, Black	200/2,000 lbs. (TW/GTW)
444153	48.40	3591 Class I 1-1/4" Drawbar Kit, Drawbar (2000 lbs. w/3/4" Ball Hole 9-3/4" Length x 5/8" Rise), Pin and Clip, Black	200/2,000 lbs. (TW/GTW)
444154	48.40	3592 Class I 1-1/4" Drawbar Kit, Drawbar (2000 lbs. w/3/4" Ball Hole 9-3/4" Length x 2-1/8" Rise x 2-3/4" Drop), Pin and Clip, Black	200/2,000 lbs. (TW/GTW)
444155	48.40	3593 Class I 1-1/4" Drawbar Kit, Drawbar (2000 lbs. w/3/4" Ball Hole 6-5/8" Length x 2-1/8" Rise x 2-3/4" Drop), Pin and Clip, Black	200/2,000 lbs. (TW/GTW)
444156	48.40	3594 Class I 1-1/4" Drawbar Kit, Drawbar (2000 lbs. w/3/4" Ball Hole 10" Length x 4" Rise), Pin and Clip, Black	200/2,000 lbs. (TW/GTW)
444157	53.57	36063 Class II Drawbar Kit, Drawbar (3500 lbs. w/3/4" Ball Hole 11-3/4" Length x 3-1/8" Rise), Pin and Clip, Black	300/3,500 lbs. (TW/GTW)
444158	99.60	36078 Class II Drawbar Kit, Drawbar (3500 lbs. w/3/4" Ball Hole 7-3/8" Length x 4-3/4" Drop), Pin and Clip, Black	300/3,500 lbs. (TW/GTW)

BALL MOUNTS

- New quick loading ball mounts feature a revolutionary angle cut design, providing a quick easy connection to the receiver
- 2" x 2" shank
- Black powder coated finish
- Angle cut design



SELECTING THE PROPER BALL MOUNT: BALL MOUNT MEASUREMENTS



DRAWBAR TYPES



PART #	MFG #	MAX GTW/TW	BALL HOLE SIZE	A LENGTH	B RISE	C DROP	STYLE	INCLUDE PIN?	U/M	
DT40342	30.67	40342-006	6000/600	1"	8-1/2"	3/4"	2	NO	EA	
DT40343	35.09	40343006	6000/600	1"	10-1/2"	3/4"	2	NO	EA	
DT40344	35.94	40344-006	6000/600	1"	9"	2-3/4"	4"	NO	EA	
DT40345	38.68	40345-006	6000/600	1"	11"	2-3/4"	4"	NO	EA	
DT40346	45.58	40346002	6000/600	1"	9-1/2"	4-3/4"	6"	NO	EA	
DT36051*	53.57	36051	3500/300	3/4"	7"	5/8"	1-1/4"	1	YES	EA
DT36053*	53.57	36053	3500/300	3/4"	9-3/4"	5/8"	1-1/4"	1	YES	EA
DT36061*	53.57	36061	3500/300	3/4"	9-3/4"	3-1/8"	3-1/2"	2	YES	EA
DT36065*	53.57	36065	3500/300	3/4"	10"	5"	5-1/2"	2	YES	EA
DT36071*	53.57	36071	3500/300	3/4"	7-3/16"	2-5/8"	3-1/4"	3	YES	EA

*COMES IN BOX WITH PIN

FAST SAME DAY SHIPPING

TRAILER CATALOG

tires & wheels
axles, hubs & springs
tongue accessories
hitches
electrical
brake parts
trailer hardware
locks & pins
towing & loading
tie downs
tools
chemicals

TRAILER

- tires & wheels
- axles, hubs & springs
- tongue accessories
- hitches**
- electrical
- brake parts
- trailer hardware
- locks & pins
- towing & loading
- tie downs
- tools
- chemicals



BY3110

BALL MOUNT - 1-1/4" SHANK

- Fits 1-1/4" receiver tubes
- Solid steel construction
- Black powder coat finish for durability & corrosion resistance
- Tongue accepts 3/4" diameter shank towing balls
- 3500 M.G.T.W., 300 lbs Maximum Vertical Load



LENGTH	MAX DROP	PART #	
9"	1 1/4"	BY3100	33.95
7"	4"	BY3110	28.36



TOWING BALL MOUNT
2" or 4" DROP

HEAVY DUTY TOWING BALL MOUNT - 2" SHANK

- Single piece solid forged shank
- Fits all 2" receiver tubes
- Black powder coated for corrosion resistance
- Tongue accepts 1" & 1-1/4" diameter shank towing balls

DESCRIPTION	M. V. L.	MAX DROP	DIAMETER	M.G.T.W.	PART #	
H/D Ball Mount	2,000#	2" Drop	1" Hole	20,000#	BY3050	51.66
H/D Ball Mount	2,000#	2" Drop	1-1/4" Hole	20,000#	BY3051	51.19
H/D Ball Mount	2,000#	4" Drop	1" Hole	20,000#	BY3055	61.36
H/D Ball Mount	2,000#	4" Drop	1-1/4" Hole	20,000#	BY3056	61.36
H/D Ball Mount	1,700#	6" Drop	1" Hole	17,000#	BY3058	72.20
H/D Ball Mount	1,700#	6" Drop	1-1/4" Hole	17,000#	BY3059	79.97

TRAILER



BY3006

BALL MOUNT - 2" SHANK

- Straight, high-low and deep drop tube style ball mounts
- Fits 2" receiver tubes
- Two piece welded steel construction
- Tongue accepts 1" diameter shank towing balls
- Available in stainless steel, chrome plated or black powder coat finish
- 6000 M.G.T.W., 600 lbs Maximum Vertical Load



DESCRIPTION	LENGTH	MAX DROP	PART #	
Straight Ball Mount	8"	2"	BY3005	26.98
Straight Ball Mount Chrome Plated	8"	2"	BY3006	33.00
High-Low Ball Mount	8"	4"	BY3010	33.94
High-Low Ball Mount Chrome Plated	8"	4"	BY3011	32.44
High-Low Ball Mount	10"	4"	BY3013	34.30
Deep Drop Ball Mount	10"	6"	BY3015	32.60
Deep Drop Ball Mount Chrome Plated	10"	6"	BY3016	51.77
Deep Drop Ball Mount	10"	8"	BY3017	38.92
Deep Drop Ball Mount Solid Shank	10.28"	10 1/4"	BY3019 *	67.14



BY3005

* Note: M.V.L. 350#
• M.G.T.W. 5,000#

M. V. L. = MAXIMUM VERTICAL LOAD

M. G. T. W. = MAXIMUM GROSS TOWING WEIGHT



BALL MOUNT - 2 1/2" SHANK

- Fits 2" receiver tubes
- 2 piece welded steel construction
- Black powder coated finish
- Tongue accepts 1-1/4" diameter shank towing balls

CAPACITY

12,000 lbs. M.G.T.W
1,200 lbs. Maximum Vertical Load

DESCRIPTION

High-Low Ball Mount, 10" Length/5" Drop

PART

BY3410 83.40



tires & wheels

axles, hubs & springs

tongue accessories

hitches

electrical

brake parts

trailer hardware

locks & pins

towing & loading

tie downs

tools

chemicals



BALL MOUNT - 2-1/2" SQUARE SHANK FOR USE WITH TITAN HITCHES

- 2-1/2" square design for use with Titan Hitches
- Ideal for marine, agricultural and recreational use
- Black powder coat finish

RISE	DROP	LENGTH	DIAMETER	M.G.T.W.	PART #	
1-1/2"	3" Drop	9-3/4"	1-1/4" Hole	14,000#	444073	143.61
3-1/2"	5" Drop	10"	1-1/4" Hole	13,000#	444074	118.25
----	7-3/4" Drop	10-1/2"	1-1/4" Hole	13,000#	444075*	172.81
1-1/2"	3" Drop	10"	1-1/4" Hole	18,000#	444076	148.38
3-1/2"	5" Drop	10"	1-1/4" Hole	18,000#	444077	161.80

* Note: Use in Drop Position Only

ADJUSTABLE BALL MOUNT - 3 POSITIONS

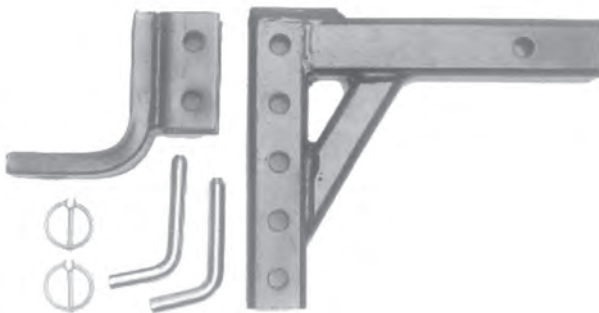

- Fits 2" receiver tubes
- Welded steel construction
- Black powder coated finish



MAX DROP	MAX LIFT	M.V.L	M.G.T.W.	PART #
11"	9-3/4"	600#	6,000#	BY3090 73.48

ADJUSTABLE BALL MOUNT - 4 POSITIONS



- Fits 2" receiver tubes
- Welded steel construction
- Black powder coated finish



MAX DROP	MAX LIFT	M.V.L	M.G.T.W.	PART #
8"	6-3/4"	600#	6,000#	BY3093 81.51

M. V. L. = MAXIMUM VERTICAL LOAD

M. G. T. W. = MAXIMUM GROSS TOWING WEIGHT

FAST SAME DAY SHIPPING

TRAILER CATALOG

HITCHES

- tires & wheels
- axles, hubs & springs
- tongue accessories
- hitches**
- electrical
- brake parts
- trailer hardware
- locks & pins
- towing & loading
- tie downs
- tools
- chemicals



BY3313



Buy 3 of the same # to receive a free display box!

BALL MOUNT KITS - 2" SHANKS



- Kit includes ball mount assembled with chrome ball and hitch pin
- Ball mounts fit 2" receiver tubes
- Chrome or black powder coated ball mount
- Two-piece welded steel construction
- 5000# chrome towing ball - 2"
- 6000# chrome towing ball - 2-5/16"
- Ball Mount Capacity: 6000 lbs M.G.T.W., 600 lbs Maximum Vertical Load

DESCRIPTION	BALL SIZE	MAX DROP	PART #	
Chrome Mount w/Chrome Ball	2"	2"	BY3306	49.75
Chrome Mount w/Chrome Ball & Receiver Lock	2"	2"	BY3306LP	63.30
Black Mount w/Chrome Ball	2"	2"	BY3307	37.38
Black Ball Mount w/Chrome Ball	2-5/16"	2"	BY3308	47.21
Black Mount w/Chrome Ball	1-7/8"	4"	BY3312	49.39
Black Mount w/Chrome Ball	2"	4"	BY3313	40.02
Black Mount w/Chrome Ball	2-5/16"	4"	BY3314	52.16

DOUBLE BALL MOUNT - 2" SHANKS



- Tube-style ball mounts with 2" drop
- Fits 2" receiver tubes
- Welded steel construction
- Weld on balls in three combinations
- Black powder coated for corrosion resistance
- Ball Mount Capacity: 6000 lbs. MGTW., 600 lbs. Max. Vertical Load



SIZE	LENGTH	MAX DROP	PART #	
1-7/8" & 2" Ball	8"	2"	BY3210	57.27
2" & 2-5/16" Ball	8"	2"	BY3215	61.38

MULTI-BALL HITCHES DOUBLE BALL MOUNT



- Each double ball mount features a solid receiver for 2" receiver tubes, welded steel towing balls, black powder coat finish, a 5/8" hitch pin hole and are individually boxed for shipping
- Offered in the 1-7/8" and 2" versions and the 2" and 2-5/16" versions

SIZE	CAPACITY	PART #	
2", 2-5/16" Ball	7,500 lbs.	BY2215	71.40

MULTI-BALL HITCHES DOUBLE BALL MOUNT



- Each double ball mount features a solid receiver for 2" receiver tubes, welded steel towing balls, black powder coat finish, a 5/8" hitch pin hole and are individually boxed for shipping
- Offered in the 1-7/8" and 2" versions and the 2" and 2-5/16" versions

SIZE	CAPACITY	PART #	
2", 2-5/16" Ball	7,500 lbs.	BY2215	71.40

M. V. L. = MAXIMUM VERTICAL LOAD

M. G. T. W. = MAXIMUM GROSS TOWING WEIGHT

ADJUSTABLE HITCHES

- Flip ball mount for added rise
- Easily remove and flip double ball assembly to change ball size
- Ball mount key locks in place for added security

MFG #	DESCRIPTION	PART #	
TRZ6PB	Deluxe 6" Powder Coat Black Drop Hitch	348044	275.99
TRZ8PB	Deluxe 6" Powder Coat Black Drop Hitch	348045	281.99
TRAZ12PB	Deluxe 12" Powder Coat Black Drop Hitch	348046	372.99



tires & wheels

axles, hubs & springs

tongue accessories

hitches

electrical

brake parts

trailer hardware

locks & pins

towing & loading

tie downs

tools

chemicals

TRAILER

ADJUSTABLE TRI-BALL MOUNT - CHROME

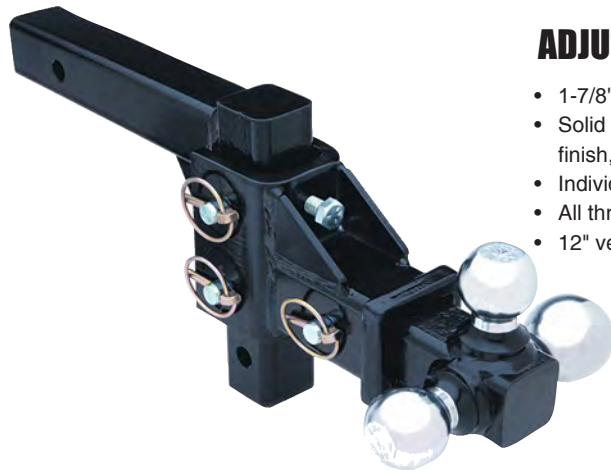

- 1-7/8", 2", 2-5/16" balls
- Solid shank for 2" receiver tubes, welded steel towing balls, black powder coat finish, and a 5/8" hitch pin hole
- Individually boxed for shipping
- All three towing ball sizes (1-7/8", 2" and 2-5/16") on one solid shank
- 12" vertical adjustment

BY2225 258.64



TRI-BALL HITCH WITH HOOK - TUBULAR



- Ball Capacity: 1-7/8" - 6,000#, 2" - 7,500#, 2-5/16" - 10,000#
- Hook Capacity: 10,000#
- Fits 2" receiver
- Black welded steel towing balls and hook
- Black powder coated finish
- 5/8" hitch pin hole
- Retail packaging

BY2208 99.10



TRI-BALL HITCH - TUBULAR

30% STRONGER!

- Ball Capacity: 1-7/8" - 6,000#, 2" - 7,500#, 2-5/16" - 10,000#
- Fits 2" receiver
- Chrome welded steel towing balls
- Black powder coated finish
- 5/8" hitch pin hole
- Lightweight for easy handling & heavy-duty towing capacity
- Packaged for retail display

BY2207 66.70

M. V. L. = MAXIMUM VERTICAL LOAD

M. G. T. W. = MAXIMUM GROSS TOWING WEIGHT

FAST SAME DAY SHIPPING

TRAILER CATALOG

61

HITCHES

- tires & wheels
- axles, hubs & springs
- tongue accessories
- hitches**
- electrical
- brake parts
- trailer hardware
- locks & pins
- towing & loading
- tie downs
- tools
- chemicals

TRAILER



RECEIVER TUBES - 2"

- 2" receiver tubes
- Cast steel collar
- Black powder coated finish
- Solid stress collar opening
- 5/8" hitch pin hole



DIMENSIONS	PART #	
2" ID x 6" Long	BY25806	39.96
2" ID x 8" Long	BY25808	45.08
2" ID x 10" Long	BY25810	49.82
2" ID x 12" Long	BY25812	58.76
2" ID x 18" Long	BY25818	77.76
2" ID x 24" Long	BY25824	109.46
2" ID x 36" Long	BY25836	145.56



RECEIVER TUBES - 1-1/4" & 2-1/2"

- Steel collar
- Plain finish



DIMENSIONS	PART #	
1-1/4" ID x 6" Long, 1/2" Pin Hole	BY1206	32.20
2-1/2" ID x 8" Long, 5/8" Pin Hole	BY5808	48.76

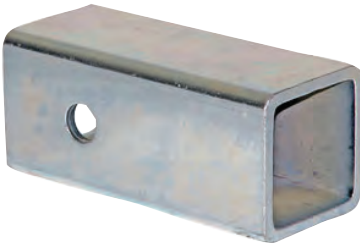

2-1/2" TO 2" RECEIVER TUBE ADAPTOR

- Reduces sleeve slides inside 2-1/2" receiver
- Accepts all 2" hitch accessories
- Zinc plated steel
- Rounded corners
- 5/8" hitch pin hole

BY252 25.38



BOLT-ON RECEIVER TUBE - 10 TON

- 2" receiver tube welded to 1/2" thick steel mounting plate with standard 4-Hole pintle hook pattern
- Cast steel collar
- Solid stress collar opening
- 5/8" hitch pin hole
- Black powder coat finish



DESCRIPTION	M. V. L.	M. G. T. W.	PART #	
2-1/5" x 6"	2,000#	20,000#	BY4055	120.12



STEP BUMPER HITCH - 2" X 2" OPENING

- Fits most full size trucks with step bumpers
- Accepts many 2" square ball mounts or accessories
- Black powder coated finish

M.V.L.	M.G.T.W.	PART #	
350#	3,500#	BY0020	69.58



M. V. L. = MAXIMUM VERTICAL LOAD

M. G. T. W. = MAXIMUM GROSS TOWING WEIGHT

tires & wheels

axles, hubs & springs

tongue accessories

hitches

electrical

brake parts

trailer hardware

locks & pins

towing & loading

tie downs

tools

chemicals

TRAILER



HITCH ADAPTER 1-1/4" TO 2"

- Converts a 1-1/4" receiver tube to a 2" hitch
- Ideal for light-duty receiver hitch accessories
- Cast steel collar
- Black powder coated finish
- 5/8" hitch pin holes
- Reduced hitch capacity

M.V.L.	PART #	
300#	BY4030	48.95



HITCH ADAPTER 2" TO 1-1/4"

- Converts a 2" receiver tube to a 1-1/4" hitch
- Cast steel collar
- Black powder coat finish
- 1/2" hitch pin included

M.V.L.	M.G.T.W.	PART #	
300#	3,000#	BY4035	35.95



RECEIVER EXTENSION

- Extend your receiver by 7", 12" or 18"
- Cast steel collar
- Accepts all 2" hitch accessories
- Black powder coat finish
- 5/8" hitch hole
- 3 lengths

DESCRIPTION	CAPACITY	PART #	
7" Receiver Extension	Reduces Hitch Capacity by 1/3	BY4003	55.04
12" Receiver Extension	Reduces Hitch Capacity by 1/3	BY4005	64.95
18" Receiver Extension	Reduces Hitch Capacity by 1/3	BY4007	93.95

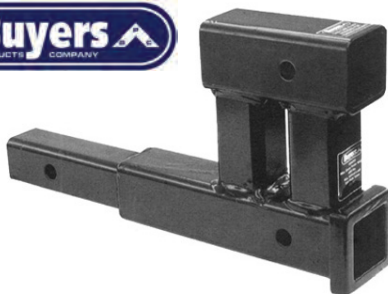

RECEIVER EXTENSION

- Dual receiver
- 12" extension

M.V.L.	M.G.T.W.	PART #	
400#	4,000#	BY4010	162.95

RECEIVER EXTENSION WITH STEP



- Same features as above
- 2 lengths 12" & 18"
- Step models include 6" x 17" welded steel step with diamond tread for extra traction

DESCRIPTION	CAPACITY	PART #	
12" Receiver Extension with Step	Reduces Hitch Capacity by 1/3	BY4015	109.30
18" Receiver Extension with Step	Reduces Hitch Capacity by 1/3	BY4017	127.56



HITCHES

- tires & wheels
- axles, hubs & springs
- tongue accessories
- hitches**
- electrical
- brake parts
- trailer hardware
- locks & pins
- towing & loading
- tie downs
- tools
- chemicals



RV BUMPER RECEIVER ADAPTER

- Fits standard 4" and 4-1/2" square RV bumpers
- Zinc plated hardware included
- Ideal for bike carriers and other accessories
- Accepts 2" tubes
- Assembly required
- Boxed (7 lbs)

Notice:

- **Not for towing**
- **Not for use on decorative aluminum bumper covers**



BY24 63.64



TRAVEL TRAILER HITCH

- Easy to install
- 2" receiver opening
- Mounts to 4" square tube bumper of RV
- Zinc plated hardware included
- M.G.T.W.: 3,500 lbs
- Tongue weight: 350 lbs
- Class II
- Assembly required
- Boxed (9.5 lbs)



BY4060 163.58



444063



444066

RECEIVER TUBE COVERS

SIZE		PART #	
2" Square	Chrome, Metal	444063	45.33
2" Square	Black Plastic	444066	4.20

TITAN 2-1/2" RECEIVER TUBE COVERS



444078

SIZE	PART #
2-1/2" Square	444078 28.46

UNIVERSAL RECEIVER TUBE COVERS



444067



444068

SIZE	PART #
2" Square Chevy Logo	444067 65.65
2" Square Dodge Ram Logo	444068 65.65

TRAILER

8-TON FORGED ALLOY STEEL COMBINATION HITCH

INCLUDES DRILLING TEMPLATE & CAPACITY DECALS



- Drop forged combination pintle hook/ball hitch
- Forged steel ball
- Interchangeable hitch balls
- Finished with black powder coat for superior durability and corrosion resistance
- Capacity: 16,000 lbs. M.G.T.W., 3,000# Maximum Vertical Load
- **BOLT KIT TO MOUNT IS NOT INCLUDED**
- Drawbar eye dimensions: 2-1/2" to 3" ID with 1-1/4" to 1-9/16" diameter section

BALL SIZE	PART #	
1-7/8"	BY4202	133.64
2"	BY4203	133.64
2-5/16"	BY4204	139.64
Pin w/Chain	BY1100	2.00



BOLT KIT TO MOUNT NOT INCLUDED
BY8520 6.30

REPLACEMENT CHROME BALL FOR THIS PINTLE

BALL SIZE	PART #	
1-7/8"	BY1780	27.60
2"	BY2000	27.60
2-5/16"	BY2516	30.96

10-TON HITCH - DROP FORGED, BLACK POWER COAT FINISH

WITH INSTALLATION INSTRUCTION SHEETS OR TEMPLATES AND CAPACITY DECALS



- Capacity: 20,000 lbs. M.G.T.W., 4,000 lbs. Maximum Vertical Load
- Drop forged combination pintle hook/ball hitch
- Forged steel ball
- Interchangeable hitch balls
- Finished with black powder coat for durability and corrosion resistance
- Drawbar eye dimensions: 2-3/8" to 3" up to 1-9/16 cross section

BALL SIZE	PART #	
2"	BY10052	223.26
2-5/16"	BY10057	235.74



BOLT KIT TO MOUNT NOT INCLUDED
BY8520 6.30

REPLACEMENT CHROME BALL FOR THIS PINTLE

BALL SIZE	PART #	
2"	BY2000	27.60
2-5/16"	BY2516	30.96



tires & wheels

axles, hubs & springs

tongue accessories

hitches

electrical

brake parts

trailer hardware

locks & pins

towing & loading

tie downs

tools

chemicals

TRAILER

HITCHES

- tires & wheels
- axles, hubs & springs
- tongue accessories
- hitches**
- electrical
- brake parts
- trailer hardware
- locks & pins
- towing & loading
- tie downs
- tools
- chemicals



Patented Design

RECEIVER MOUNT - COMBINATION BALL HITCH - 6 TON

WITH INSTALLATION INSTRUCTION SHEETS OR TEMPLATES AND CAPACITY DECALS

- Single piece, drop forged lower jaw
- Integral shank fits all 2" receiver tubes
- Finished with black powder coat for superior durability and corrosion resistance
- Eliminates the need for a more costly assembly consisting of a ball hitch, pintle mount and mounting hardware, plus a significant weight savings
- Individually boxed for storage, shipping and retail display
- Drawbar eye dimensions: 2-1/2" to 3" ID with 1-1/4" to 1-9/16" diameter section
- Capacity: 12,000 lbs. M.G.T.W., 2,400# Maximum Vertical Load

BALL SIZE	PART #	
1-7/8"	BY61780	126.95
2"	BY62000	182.10
2-5/16"	BY62516	185.08
Pin w/Chain	BY1100	2.00

REPLACEMENT CHROME BALL FOR THIS PINTLE

BALL SIZE	PART #	
1-7/8"	BY1780	27.60
2"	BY2000	27.60
2-5/16"	BY2516	30.96

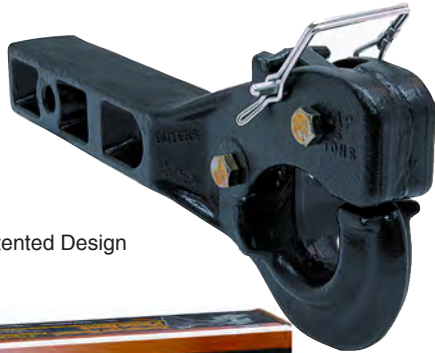

Patented Design



RECEIVER MOUNT - PINTLE HOOK, 5 TON

WITH INSTALLATION INSTRUCTION SHEETS OR TEMPLATES AND CAPACITY DECALS

- Single piece, drop forged lower jaw
- Integral shank fits all 2" receiver tubes
- Finished with black powder coat for superior durability and corrosion resistance
- Eliminates the need for a more costly assembly consisting of a pintle hook and mounting hardware, plus a significant weight savings
- Individually boxed for storage, shipping and retail display
- Drawbar eye dimensions: 2" to 3" ID with 1-1/4" to 1-5/8" diameter section
- Capacity: 10,000 lbs. M.G.T.W., 2,000# Maximum Vertical Load

DESCRIPTION	PART #	
Receiver Mount - Pintle Hook	BY0050	118.80



TRAILER



OPEN



CLOSED

TRI-BALL MOUNT WITH PINTLE HOOK

- Features 3 towing balls and a pintle hook on 1 solid steel shank
- Black powder coated shank fits 2" receivers
- 5/8" Hitch Pin hole
- 1-7/8", 2", 2-5/16" welded steel tubing ball
- 7500# cast steel pintle jaw
- Upper jaw locks in the open (up) position for coupler towing
- Upper jaw locks in the closed (down) position for lunette eye towing



BY2279 193.80

CAPACITY	
1-7/8" Ball	6,000 lbs M.G.T.W.
2" Ball	7,500 lbs M.G.T.W.
2-5/16" Ball	10,000 lbs M.G.T.W.
Pintle cap	7,500 lbs M.G.T.W.

M. V. L. = MAXIMUM VERTICAL LOAD

M. G. T. W. = MAXIMUM GROSS TOWING WEIGHT



RIGID TYPE PINTLE HOOK - 15 TON

INCLUDES MOUNTING INSTRUCTIONS

- Drop forged steel
- Black powder coated finish
- Locking pin included
- Drawbar eye dimensions: 2" to 3" ID with 1-1/4" to 1-5/8" diameter section

	M. V. L.	M. G. T. W.	PART #	
15 Ton	6,000#	30,000#	BY4206	101.98



**BOLT KIT TO MOUNT
NOT INCLUDED**
BY8520 6.30

tires & wheels

axles, hubs & springs

tongue accessories

hitches

electrical

brake parts

trailer hardware

locks & pins

towing & loading

tie downs

tools

chemicals



RIGID TYPE PINTLE HOOK - 20 TON

INCLUDES MOUNTING INSTRUCTIONS

- Drop forged steel
- Black powder coated finish
- Locking pin included
- Drawbar eye dimensions: 2" to 3" ID with 1-1/4" to 1-5/8" diameter section

	M. V. L.	M. G. T. W.	PART #	
20 Ton	8,000#	40,000#	BY4220	123.68



**BOLT KIT TO MOUNT
NOT INCLUDED**

BY8525 10.00

PINTLE HOOK MOUNT

These mounts are designed to adapt receiver tubes to multi-height pintle hook applications

- Continuous welds
- Epoxy coating
- Solid shank
- 10,000# capacity
- 2" Shank diameter
- 1,000# tongue weight



BY812



BY870

SHANK DIMENSIONS	PLATE DIMENSIONS	PAIR OF HOLES	M. V. L.	M. G. T. W.	PART #	
2" x 9"	5" x 7.38"	4	2,000#	10,000#	BY870	70.58
2" x 10.25"	5" x 7.38"	4	2,000#	10,000#	BY107	80.14
2" x 12.25"	5" x 12.50"	7	2,000#	10,000#	BY812	105.68
2" x 9"	5" x 3.75"	2	4,000#	20,000#	BY840	66.50
2" x 10.25"	5" x 5.75"	3	2,800#	14,000#	BY105	67.82

M. V. L. = MAXIMUM VERTICAL LOAD

M. G. T. W. = MAXIMUM GROSS TOWING WEIGHT

FAST SAME DAY SHIPPING

TRAILER CATALOG

HITCHES

- tires & wheels
- axles, hubs & springs
- tongue accessories
- hitches**
- electrical
- brake parts
- trailer hardware
- locks & pins
- towing & loading
- tie downs
- tools
- chemicals

TRAILER



RECEIVER MOUNT TOW HOOK

- Fits 2" receiver tubes
- 10,000# capacity
- Black powder coat finish resists corrosion
- Straight pattern



BY10H 39.12



FORGED RECEIVER MOUNT TOW HOOK

- Fits 2" receiver tubes
- 12,000# capacity
- Black powder coat finish to resist corrosion
- Straight pattern



BY12H 56.10



FORGED RECEIVER MOUNT TOW EYE

- Fits 2" receiver tubes
- 12,000# capacity
- Black powder coat finish to resist corrosion
- Straight pattern



BY1225E 56.10



DROP FORGED HEAVY DUTY TOWING HOOK

- 3 hole
- Black finish
- 12,000# safe working load (per hook)



BY076 35.32



HEAVY DUTY TOWING SHACKLE

- Drop forged
- Black finish
- 18,000# safe working load (per hook)



BY0681 96.66



CLEVIS BALL MOUNTS

- Fits 2" receiver tubes
- Uses 1" diameter shank towing ball
- Black powder coated finish
- 9-1/4" length



M.V.L.	M.G.T.W.	PART #	
600#	6000#	BY3060	46.99
800#	8000# (Solid Shank)	BY3065	56.83



FORGED ALLOY STEEL DRAWBAR WITH NUT

DESCRIPTION	M. V. L.	M. G. T. W.	PART #	
2.5" I. D. Eye, 5-1/2" OD, 1-1/2" Section Drawbar	3,000#	15,000#	BY2503	78.95
3" I.D. Eye, 6-1/4" OD, 1-5/8" Section Drawbar	9,000#	45,000#	BY2492	108.54





4-BOLT MOUNT DRAWBAR

- Alloy steel forging
- Black powder coated finish
- 2-1/2" ID eye with 1-1/2" section
- Drawbar welded to 4 hole square mounting plate

M.V.L.	M.G.T.W.	PART #	
7,000#	42,000#	BY25015	118.20



4-BOLT MOUNT DRAWBAR

- One piece forged design
- Alloy steel forging
- Black powder coat finish
- 2-1/2" ID eye with 1-1/2" section drawbar with 4 hole mounting plate

M.V.L.	M.G.T.W.	PART #	
7,000#	42,000#	BY12515	116.10



HEAVY DUTY FORGED 4-BOLT MOUNT DRAWBAR

- One piece forged design for safety and capacity
- Alloy steel forging
- Black powder coat finish
- 3" ID eye with 1.62 section drawbar with 4 square mounting holes
- .78" mounting hole size

M.V.L.	M.G.T.W.	PART #	
15,000#	60,000#	BY1385	162.32



ADJUSTABLE EYE ASSEMBLY

3 POSITION CHANNEL AND FASTENERS

- Ductile cast iron eye
- Formed steel channel
- 3" ID eye opening
- 1-9/16" eye section

M.V.L.	M.G.T.W.	PART #	
2,000#	12,000#	BY18128	105.30



5 POSITION CHANNEL AND FASTENERS

- Ductile cast iron eye
- Formed steel channel
- 3" ID eye opening
- 1-9/16" eye section

M.V.L.	M.G.T.W.	PART #	
2,000#	14,000#	BY20135	148.84



EYE ONLY



- Ductile cast iron eye
- 3" ID eye opening
- 1-9/16" eye section

M.V.L.	M.G.T.W.	PART #	
2,000#	14,000#	BY16137	46.18

tires & wheels

axles, hubs & springs

tongue accessories

hitches

electrical

brake parts

trailer hardware

locks & pins

towing & loading

tie downs

tools

chemicals

TRAILER

M. V. L. = MAXIMUM VERTICAL LOAD

M. G. T. W. = MAXIMUM GROSS TOWING WEIGHT

FAST SAME DAY SHIPPING

TRAILER CATALOG

HITCHES

- tires & wheels
- axles, hubs & springs
- tongue accessories
- hitches**
- electrical
- brake parts
- trailer hardware
- locks & pins
- towing & loading
- tie downs
- tools
- chemicals

BUYERS SAFETY CHAINS

Zinc plated. With quick link connectors all except **BY3835** are display packaged. **BY3835** has a slip hook, **BY11275** has a clevis style slip hook.



PART #	MFG #	CLASS	BREAKING STRENGTH	SIZE	U/M	
BY11215	17.12	11215	II	5000#	9/32"X48"	EA
BY3254	13.95	B93254SC	II	5000#	9/32"X54"	EA
BY11220	19.00	11220	II	5000#	9/32"X72"	EA
BY3835	21.95	B03835SC	IV	10,000#	3/8"X35"	EA
BY11275	30.04	11275	IV	15,000#	3/8"X35"	EA



BY3835



BY3254

BUYERS QUICK LINK CONNECTOR

Zinc plated. Ideal for connecting chains, cables, wires and ropes.



PART #	MFG #	SIZE	U/M
BY0038	4.40	7350038	3/8" EA

SMITH SAFETY CHAINS

Display packaged. Trailer safety chains with heat treated S-hooks. Zinc plated for corrosion resistance. Does not come with quick connectors.



PART #	MFG #	CLASS	BREAKING STRENGTH	SIZE	U/M
CS16651	25.65	16651A	I	2000#	3/16" PR
CS16661	28.19	16661A	II	3500#	5/0 PR
CS16671	30.79	16671A	III	5000#	1/4" PR
CS16681	44.91	16681A	IV	7600#	8/0 PR



SMITH SAFETY HOOKS

Sold each (bulk). S-Hooks for trailer safety chain. Zinc.



PART #	MFG #	BREAKING STRENGTH	STYLE	U/M
CS16640	1.95	16640	"S" HOOK	EA
CS16642	1.75	16642	"S" HOOK	EA
CS16795	7.95	16795A	SNAP HOOK	EA



CS16640



CS16795

SMITH "S" HOOK KEEPERS

Fastens over S-hook after chain is attached to the vehicle. Prevents chain from bouncing off. Comes packaged as a pair.

PART #	MFG #	U/M
CS16691	11.14	16691A PR



TRAILER

TIE DOWN SAFETY CHAINS

Zinc plated trailer safety chains are skin packed with S-hooks.

PART #	MFG #	CLASS	BREAKING STRENGTH	SIZE	U/M
LR81202	16.76	81202	II	3500#	3/16"X31" PR
LR81203	22.05	81203	III	5000#	1/4"X31" PR
LR81204	42.29	81204	IV	7500#	5/16"X40-3/4" PR
LR81205	15.50	81205	II	3500#	3/16"X36" EA



TIE DOWN HITCH CABLES

Replace your noisy chains with self-coiling hitch cables. Available plain or jacketed. Both use durable galvanized aircraft cable construction. Each pair is skin packaged.

PART #	MFG #	CLASS	BREAKING STRENGTH	SIZE	FINISH	U/M
LR59533	25.59	59533	I	2000#	36" BLACK VINYL JACKETED	PR
LR59535	23.49	59535	II	3500#	36" GALVANIZED	PR
LR59537	25.29	59537	II	3500#	36" BLACK VINYL JACKETED	PR
LR59539	31.27	59539	III	5000#	36" GALVANIZED	PR
LR59541	31.96	59541	III	5000#	36" BLACK VINYL JACKETED	PR
LR59543	31.88	59543	IV	7000#	36" GALVANIZED	PR
LR59545	32.10	59545	IV	7000#	36" BLACK VINYL JACKETED	PR
LR59548*	36.16	59548	IV	7000#	36" BLACK VINYL JACKETED	PR

LR59548* COMES WITH SAFETY LATCH HOOK



MODEL LR59548 WITH LATCH HOOK

TIE DOWN THREADED LINKS

Quick links ideal for trailer chains. Zinc plated for rust prevention.

PART #	MFG #	SIZE	U/M
LR50648	3.47	50648	5/16" 1 PER PKG
LR50649	5.05	50649	3/8" 1 PER PKG



TIE DOWN LATCH HOOK

Zinc plated latch hook skin packaged each.

PART #	MFG #	BREAKING STRENGTH	U/M
LR50640	6.44	50640	7000# EA
LR50645	11.52	50645	7500# EA
LR50641	11.30	50641	12000# EA



TIE DOWN "S" HOOK SAFETY CHAIN KEEPER

These patented safety chain keepers attach easily to the "s" hooks to keep your chains secure to the vehicle. Retail packaged 2 per package.

PART #	MFG #	U/M
LR81255	6.61	81255 PR



tires & wheels

axles, hubs & springs

tongue accessories

hitches

electrical

brake parts

trailer hardware

locks & pins

towing & loading

tie downs

tools

chemicals

TRAILER

HITCHES

- tires & wheels
- axles, hubs & springs
- tongue accessories
- hitches**
- electrical
- brake parts
- trailer hardware
- locks & pins
- towing & loading
- tie downs
- tools
- chemicals

TRAILER



TRAILER NOSE PLATE

- Accepts standard 4-1/2" square bolt pattern found on most drawbars
- Allows 3 mounting positions



THICKNESS	HOLES	MEASUREMENTS	PART #	
3/4"	8-21/32"	30,000#	BY25750	96.95

WINCH MOUNTING PLATE



Our front mounted receivers are rated for 9,000 lbs. line pull. This makes them ideal for use with winches. We offer a winch adapter that connects the winch to the receiver. They accept most models of Superwinch, Ramsey and Warn. Will not fit with S4500 Superwinch.



PART #	MFG #	DESCRIPTION	U/M
444115	245.98	6495 Front Mount Receiver Accessory, Winch Mounting Plate	EA
444116	207.48	6980 Handle Kit for 444115 Winch Mounting Plate	EA



DRAWBAR LOCK

- Zinc plated
- Fits all 2-1/2"-3" lunette eyes
- Accept most 1/2" diameter padlocks (not included)



BY253 31.48



WRENCH FOR HITCH BALLS

Boxed ends, 1-1/8" & 1-1/2". Zinc finish.

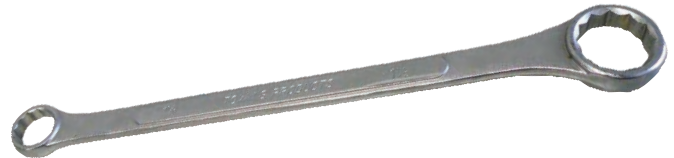

444161 29.70

NUT & WASHER REPLACEMENT 1-1/4"

Nut and washer kits packaged shank reducers. Sold bulk.

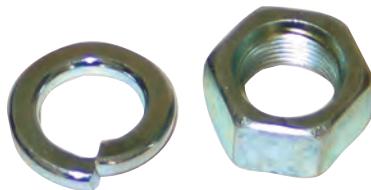

PART #	MFG #	U/M
BY2092	2.95	1802092 EA

HITCH BALL COVERS

Fits 1-7/8"-2" trailer balls with an adjustable inside spring to stay snug.



PART #	COLOR	U/M
571761	0.30 BLACK	EA



AUTOMATIC
DISTRIBUTORS

TRAILER CATALOG

ELECTRICAL

- tires & wheels
- axles, hubs & springs
- tongue accessories
- hitches
- electrical
- brake parts
- trailer hardware
- locks & pins
- towing & loading
- tie downs
- tools
- chemicals

TRAILER



- Includes grommet and plug
- Retail packaged



- Includes grommet and plug
- Retail packaged



- Includes grommet and plug
- Retail packaged



- Includes grommet and plug
- Retail packaged



◆ Connect black wires for synchronized strobe pattern or leave unconnected for random strobe pattern.

New harder durometer rubber seal for better light fit

New wider base prevents vibration



LED LIGHTS

ALL LIGHTS ARE DOT & SAE APPROVED

LED STOP, TURN, TAIL LIGHTS RED

PART #		MFG #	DESCRIPTION
BY26520	22.16	5626520	6-1/2" Oval Light - 20 Diodes
BY24118	20.76	5624118	4" Round Light - 18 Diodes



LED BACK-UP LIGHTS CLEAR

PART #		MFG #	DESCRIPTION
BY26324	39.86	5626324	6-1/2" Oval Light - 24 Diodes
BY24324	39.86	5621324	4" Round Light - 24 Diodes



LED TURN & PARK LIGHTS AMBER

PART #		MFG #	DESCRIPTION
BY26210	16.70	5626210	6-1/2" Oval Light - 10 Diodes
BY24210	16.70	5624210	4" Round Light - 10 Diodes



LED MARKER LIGHTS AMBER & RED

PART #		MFG #	DESCRIPTION
BY27523	7.95	5627523	3/4" Round Light - 3 Diodes - Amber
BY27513	7.95	5627513	3/4" Round Light - 3 Diodes - Red



LED STROBE LIGHTS

- 100,000 hour rated life - Quad flash amber or clear strobe light
- 12-24 VDC - 3 pin quick plug wire harness & grommet included (BY6500 & BY4000)
- No external power pack required - BY6502 & BY4002 are direct wired
- Retail packaged

PART #		MFG #	DESCRIPTION
BY6500	50.04	SL65AO	6-1/2" Oval Strobe Light - Amber
BY6502	52.84	SL65CO	6-1/2" Oval Strobe Light - Clear
BY4000	50.58	SL40AR	4" Round Strobe Light - Amber

LED UTILITY LIGHT CLEAR

- Rugged all purpose utility light - Shock resistant & waterproof
- 5" sealed rubber housing with polycarbonate lens
- 4.92" H x 3.15" D x 7" H
- Retail packaged

PART #		MFG #	DESCRIPTION
BY2110	41.50	1492110	54 Diodes



STOP / TURN / TAIL LIGHTS



LED 6" OVAL SEALED SURFACE MOUNT STOP/TURN/TAIL LIGHT

- Features sonically sealed, waterproof lens and housing in a single unit - Hardwired
- Surface mount unit does not require panel cut out
- Clamshell packaged

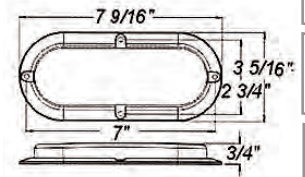

PART #	MFG #	DESCRIPTION
OP1118	38.07	STL-78RK 10 Diodes



LED 6" OVAL SEALED FLUSH MOUNT STOP/TURN/TAIL LIGHT

- Features sonically sealed, waterproof lens and housing in a single unit complete with grommet and 3 prong pigtail
- Replacement grommet and 3 prong pigtail available
- Clamshell packaged

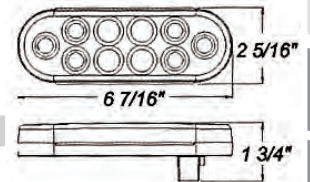

PART #	MFG #	DESCRIPTION
OP726	38.75	STL-72RK 10 Diodes



LED 4" ROUND SEALED FLUSH MOUNT STOP/TURN/TAIL LIGHT

- Features sonically sealed, waterproof lens and housing in a single unit complete with grommet and 3 prong pigtail
- Replacement grommet and 3 prong pigtail available
- Clamshell packaged

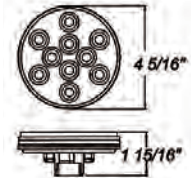

PART #	MFG #	DESCRIPTION
OP436	41.92	STL-43RK 10 Diodes



LED THIN LINE DUAL LENS STOP/TURN/TAIL LIGHT

- Features replaceable, red outer lens stream line designed - Clear polycarbonate inner lens is sonic welded to housing for durability
- Packaged in bulk

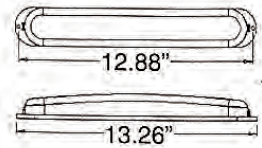

PART #	MFG #	DESCRIPTION
OP766	38.70	STL-76RB 11 Diodes



UNIVERSAL STUD MOUNT STOP/TURN/TAIL/BACK-UP & LICENSE LIGHTS

Universal stud-mount stop, turn, tail, back-up and license light. Features screw-on, replaceable lens and easy to change replaceable bulbs. Shock proof socket guarantees long bulb life. All-weather molded plastic housing and durable lens protect against corrosion. Surface mount with three 1/4" studs. Grounds through mounting studs. Available in both bulk and colorful retail packaging.

PART #	MFG #	DESCRIPTION
OP1120	20.87	ST-60RS Display Packaged
OP1122	15.02	ST-60RS Bulk
OP1124	2.55	AR60RB Repl. Lens

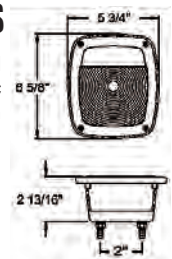

6" OVAL STOP/TURN/TAIL LIGHT FOR FLUSH MOUNT



Sealed red stop/turn/tail light for flush mount. Features sonically sealed, waterproof lens and housing in a single unit. Shock proof socket guarantees long bulb life. Complete with grommet (PM42118) and 3 wire plug (PM431491). Available in colorful retail packaging.

PART #	MFG #	DESCRIPTION
OP708	14.37	ST070RK Red

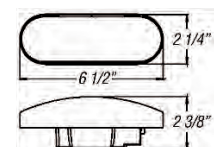

4-3/4" ROUND STOP/TURN/TAIL LIGHTS



4-3/8" round stop/turn/tail lights with black polymer housings. Mounts with two 1/4" studs on 2" centers. Features plastic housing, snap-on replaceable lens and easy to change replaceable bulb (#GE1034/GE2057). Available in both bulk and colorful retail packaging.

BULK PART #	MFG #	PACKAGED PART #	MFG #	DESCRIPTION
OP1126	5.97	ST24RB	OP1116	8.80 ST20RS Left Side
OP1127	5.61	ST25RB	OP1117	9.27 ST21RS Right Side
OP1129	1.65	A-24RB	OP1129	1.65 A-24RB Repl. Lens

- tires & wheels
- axles, hubs & springs
- tongue accessories
- hitches
- electrical
- brake parts
- trailer hardware
- locks & pins
- towing & loading
- tie downs
- tools
- chemicals

TRAILER



STOP, TURN, & TAIL LIGHTS

- tires & wheels
- axles, hubs & springs
- tongue accessories
- hitches
- electrical
- brake parts
- trailer hardware
- locks & pins
- towing & loading
- tie downs
- tools
- chemicals

UNDER 80" WIDE COMBINATION TAIL LIGHTS



• Under-80" combination tail light. Includes the following functions: stop, turn, tail, rear reflex, side marker, side reflex, and license light (PM444 only) • Mounts on 2" centers and includes mounting hardware • Grounds through 1/4" mounting studs • These lights also replace lights on PM540 and PM541 light kits

PART #		MFG #	DESCRIPTION
PM440	12.82	V440	6 Function RH
PM444	12.79	V440L	7 Function LH
PM44015	4.38	440-15	Rear Replacement Lens
PM5515	4.98	55-15R	Side Replacement Lens

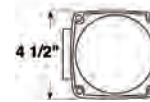
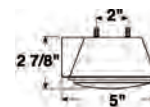

V440

OVER 80" WIDE SUBMERSIBLE COMBINATION TAIL LIGHTS

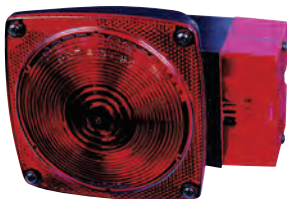

• Under-80" combination tail light. Includes the following functions: stop, turn, tail, rear reflex, side marker, side reflex, and license light (PM4521 only) • Mounts on 2" centers and includes mounting hardware • Grounds through mounting studs • These lights also replace lights on PM544 light kit

PART #		MFG #	DESCRIPTION
PM452	20.06	V452	6 Function RH
PM4521	21.43	V452L	7 Function LH
PM44015	4.38	440-15	Rear Replacement Lens
PM5615	4.96	56-15R	Side Replacement Lens

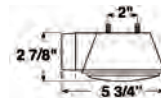

V452

OVER 80" WIDE SUBMERSIBLE COMBINATION TAIL LIGHTS

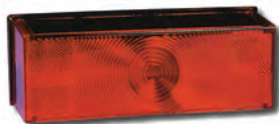

• Low-profile, over-80" submersible combination tail light • Includes the following functions: stop, turn, tail, rear clearance, rear reflex, side marker, side reflex, and license light (PM4561 only) • Grounds through separate lead wire • Mounts on slide-on 2" centers and includes mounting hardware • These lights also replace lights on PM547 light kit

PART #		MFG #	DESCRIPTION
PM456	23.10	M456	6 Function RH
PM4561	23.95	M456L	7 Function LH

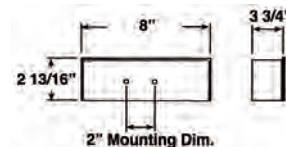

V456

SEALED ROUND 4" STOP, TURN, & TAIL LIGHT



• Sealed, 4" round stop, turn, and tail light may be used on both curbside and roadside of vehicle or trailer • Features extra wide, spin welded, tongue-and-groove lens lip and waterproof seal • Can be purchased as a kit with grommet and 3 wire plug or each piece can be purchased separately.

PART #		MRF #	DESCRIPTION
PM4260	18.65	Y426KR	Light Kit
PM426	10.70	426R	Light Only
PM42618	5.58	426-18	Grommet Only
PM431491	6.26	431-491	3-Wire Plug Only

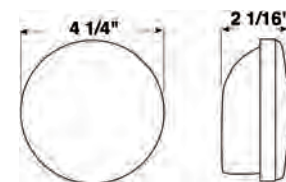

V426R

SEALED OVAL STOP, TURN, & TAIL LIGHT



• Sealed, oval stop, turn, and tail light may be used on both curbside and roadside of vehicle or trailer • Legal in either horizontal or vertical position • Polycarbonate lens is welded to housing to form single unit • Can be purchased as a kit with grommet and 3 wire plug or each piece can be purchased separately.

PART #		MFG #	DESCRIPTION
PM4210	18.74	V421KR	Light Kit
PM421	12.02	V421R	Light Only
PM42118	5.74	421-18	Grommet Only
PM431491	6.26	431-491	3-Wire Plug Only

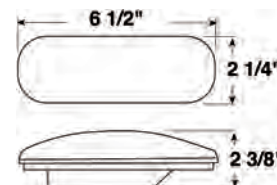

V421R

UNIVERSAL MOUNTING BRACKET



- Black powder-coat finish
- 3" wide x 4-1/2" tall
- For use with most Peterson stud mount lights

PART #		MFG #	DESCRIPTION
PM5109	6.57	510-9	Black Steel - Bulk

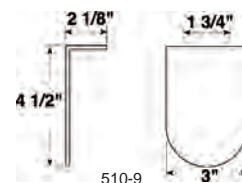

510-9

TRAILER



TRAILER LIGHTING

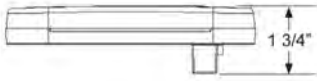

LED 6" OVAL S/T/T KIT WITH GROMMET & PLUG

- Includes grommet
- 'TRY ME' packaging
- Polycarbonate lenses and housing are sonic welded
- Grommet mount

PART #	MFG #	DESCRIPTION
989025	30.19	C561RTM GROMMET & PLUG
989027	36.19	C563RTM SURFACE MOUNT



LED 6" OVAL PARK/TURN (AMBER) KIT WITH GROMMET & PLUG

- Includes grommet
- 'TRY ME' packaging
- Polycarbonate lenses and housing are sonic welded
- Grommet mount

PART #	MFG #	DESCRIPTION
989026	28.89	C561ATM GROMMET & PLUG

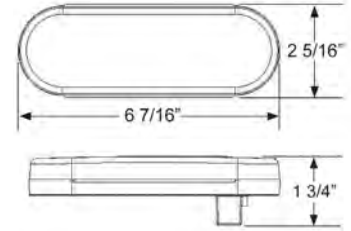

LED UNIVERSAL S/T/T

- Includes Light only
- 'TRY ME' Packaging
- Polycarbonate housing and acrylic lens are sonically welded to create full sealed light
- 6 functions - Stop/Tail/Turn, Rear, Reflex, Back-up, and License Illuminator
- Industry standard 3 stud mounting pattern on 2" centers
- S/T/T 16 diodes, Back-up 18 diodes, License Illuminator 5 diodes
- 39 Diodes

PART #	MFG #	DESCRIPTION
989028	96.49	C599SWTM UNIVERSAL S/T/T

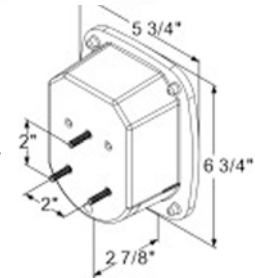

LED LOW PROFILE OVER/UNDER 80" S/T/T LIGHT PASSENGER SIDE

- Includes Light with chrome bezel
- Ideal use on boat trailers
- STI approved
- 9 Diode

PART #	MFG #	DESCRIPTION
989031	48.29	C7298TM LOW PROFILE S/T/T

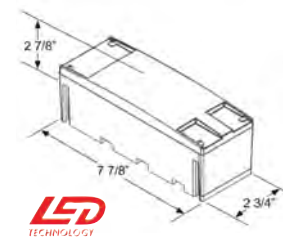

LED LOW PROFILE OVER/UNDER 80" - LEFT HAND SIDE

- Includes Light only
- 'TRY ME' Packaging
- Low profile design
- Combination 7 function left hand side light with license plate illuminator and replacement for 989036 Light Kit
- 14 Diodes

PART #	MFG #	DESCRIPTION
989030	48.29	C7288TM LED LOW PROFILE OVER/UNDER 80"

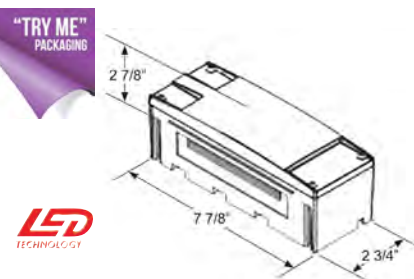

LED SLIM PROFILE STOP/TAIL/TURN WITH CHROME BEZEL

- Includes Light with chrome bezel
- Ideal use on boat trailers - For use on trailers over 80 in. wide
- STI approved
- 9 Diode

PART #	MFG #	DESCRIPTION
989029	36.19	C561ATM SLIM PROFILE S/T/T



- tires & wheels
- axles, hubs & springs
- tongue accessories
- hitches
- electrical
- brake parts
- trailer hardware
- locks & pins
- towing & loading
- tie downs
- tools
- chemicals

TRAILER

FAST SAME DAY SHIPPING

COMBINATION UNDER 80" TAIL LIGHTS #80 SERIES



Universal 2" on center stud mounting. Screw-on main and side marker lens allow for easy bulb replacement. This tail light is designed for a variety of under 80" light-duty trailers. Wiring uses the quick connect and disconnect feature. These tail lights meet FMVSS/CMVSS 108 requirements. 4 3/4" x 4 1/2" x 2 9/16"

PART #		MFG #	DESCRIPTION
444051	14.07	2823283	7 Function, Left/Roadside Under 80"
923060	13.93	2323284	6 Function, Right/Curbside Under 80"

Complete kit with two tail lights, two amber clearance/side marker lights with reflex lens, 20' or 25' trailer wiring harness cable with molded 4-way flat prong plug, 4' car wiring harness cable with molded 4-way flat prong plug plus license plate bracket.

PART #		MFG #	DESCRIPTION
444053	61.20	2823285	Trailer Light Kit w/25' Wire Harness w/ Rectangular Clearance/Side Marker Lights
927500	59.93	407500	Trailer Light Kit w/20' Wire Harness w/o Clearance/Side Marker Lights

REPLACEMENT PARTS			
PART #		MFG #	DESCRIPTION
923211	5.37	003211	License Plate Bracket
927275	8.56	707275	4' Wiring Harness w/4 Way Flat Car End

COMBINATION OVER 80" TAIL LIGHTS #80 SERIES



Universal 2" on center stud mounting. Screw-on main and side marker lens allow for easy bulb replacement. These tail lights meet FMVSS/CMVSS 108 requirements for trailers over 80" wide when properly mounted. Wiring uses the quick connect and disconnect feature. 6.09" x 4.59" x 2.87"

PART #		MFG #	DESCRIPTION
444054	17.54	2823293	8 Function, Left/Roadside Over 80"
444055	16.75	2823294	7 Function, Right/Curbside Over 80"

SUBMERSIBLE UNDER 80" TAIL LIGHTS



These lights are ideal for boat and PWC trailers less than 80" wide. Fully gasketed, screw on main and side marker lens allow for easy bulb replacement. Universal 2" on-center stud mount. 5.25" x 4.66" x 3.76" overall height.

PART #		MFG #	DESCRIPTION
444056	19.74	2523073	6 Function, Right/Curbside Submersible Under 80"
444057	20.74	2523023	7 Function, Left/Roadside Submersible Under 80"

This kit comes complete with two pre-wired tail lights. 25' trailer wiring harness cable with molded four prong plug, 4' four wire car wiring harness cable with molded 4-way plug plus license plate bracket.

PART #		MFG #	DESCRIPTION
444050	69.63	2527511	Trailer Light Kit w/25' Wire Harness Submersible Under 80"

REPLACEMENT LENSES



REPLACEMENT LENS FOR WesBarg 80 SERIES TAILLIGHT	
PART #	
928580	4.48

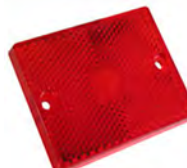

REPLACEMENT SIDE LENS FOR WesBarg UNDER 80 SERIES TAILLIGHT	
PART #	
928581	0.85

- tires & wheels
- axles, hubs & springs
- tongue accessories
- hitches
- electrical
- brake parts
- trailer hardware
- locks & pins
- towing & loading
- tie downs
- tools
- chemicals

SUBMERSIBLE 4X6 OVER 80" TAIL LIGHTS



Unique, compact size and shape allows these lights to fit where space is limited. The lens is sonically-sealed to the base providing a "bell jar", making this lamp fully submersible with easily replaceable bulbs. These lights meet FMVSS/CMVSS 108 requirements for trailers over 80" wide when properly mounted. Pre-wired with molded plugs for easy installation. Size is 6" x 3-1/2" x 2-1/4"

PART #	MFG #	DESCRIPTION
923075	33.03	403075 7 Function, Right/Curbside Submersible - 4X6 - Over 80"
923025	33.32	403025 8 Function, Left/Roadside Submersible - 4X6 - Over 80"



The kit comes complete with two tail lights, two amber clearance/side marker lights with reflex lens, 20' trailer wiring harness cable with molded four prong plug, 4' four wire car wiring harness cable with molded 4-flat plug plus license plate bracket.

PART #	MFG #	DESCRIPTION
444048	84.21	407515 Trailer Light Kit w/20' Wide Harness Submersible - 4X6 - Over 80"

REPLACEMENT PARTS

PART #	MFG #	DESCRIPTION
444041	11.76	203117 Clearance/Side Marker, Amber, Stud Mount
444044	6.21	003338 Lens Amber, Clearance/Sidemarkers w/Screw

SUBMERSIBLE OVER 80" TAIL LIGHTS



These lights are ideal for boat and PWC trailers over 80" wide. Fully gasketed, screw on main and side marker lenses allow for easy bulb replacement. Universal 2" on-center stud mount. These lights meet FMVSS/CMVSS 108 requirements for trailers over 80" wide when properly mounted. Pre-wired for easy installation. Size is 6.29" x 4.66" x 3.76" overall height.

PART #	MFG #	DESCRIPTION
444059	21.64	2523024 8 Function, Left/Roadside Submersible - Over 80"

WATERPROOF 3" X 8" OVER 80" LOW PROFILE TAILLIGHTS



Featuring a reliable waterproof design, these lights have a bulb replaceable capsule that protects the bulbs from corrosion and thermal shock but still allows for easy access for bulb replacement. These lights meet FMVSS/CMVSS 108 requirements for trailers over 80" wide when properly mounted. Size is 8" x 2 7/8" x 2 3/4"

PART #	MFG #	DESCRIPTION
923076	25.06	403076 7 Function, Right/Curbside Waterproof - 3X8 - Over 80"
923026	25.22	403026 8 Function, Left/Roadside Waterproof - 3X8 - Over 80"

WATERPROOF OVER 80" LOW PROFILE TAILLIGHTS

6.09" W x 4.59" H x 2.87" D

The kit comes complete with two tail lights, two sealed amber surface mount clearance/side marker lights with reflex lens, 25' trailer wiring harness cable with molded four prong plug, 4' four wire car wiring harness cable with molded 4-way plug plus license plate bracket.



PART #	MFG #	DESCRIPTION
927509	110.97	007509 Trailer Light Kit w/25' Harness Waterproof - 3X8 - Over 80"

REPLACEMENT PARTS

PART #	MFG #	DESCRIPTION
923336	28.84	403336 Lens Set Red, 2 tail and 2 Clearance/Side Marker w/Screws
923111	15.09	203111 Clearance Light Amber w/Black Stud Mount Base

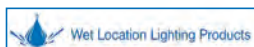

- tires & wheels
- axles, hubs & springs
- tongue accessories
- hitches
- electrical
- brake parts
- trailer hardware
- locks & pins
- towing & loading
- tie downs
- tools
- chemicals



TRAILER LIGHT KITS

EACH ITEM SHOWN HERE CAN BE PURCHASED SEPARATELY

UNIVERSAL SUBMERSIBLE UNDER 80" TRAILER LIGHT KIT



Kit includes 2 submersible stud mount tail lights and a corrosion proof license plate bracket • Retail packaged

PART #	DESCRIPTION	REPL. LENS (BULK)
OP900	41.85 (1) Light Kit (As Shown)	----
OP902	12.75 (1) Right Side Tail Light	Rear OP170, Side OP172
OP904	13.22 (1) Left Side Tail Light	Rear OP170, Side OP172
OP250	24.87 (1) 25' Wire Harness (Wishbone)	----

(1) license plate bracket (polymer)

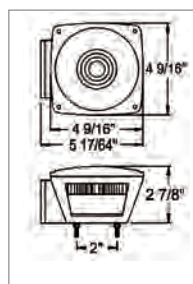

OP170	4.90
OP172	2.83

UNIVERSAL UNDER 80" TRAILER LIGHT KIT

Grounds through mounting studs • Mounts on 2" centers • Shock proof socket for longer bulb life • Includes 2 stud mount Plug-N-Go taillights • License plate bracket • 25-ft wiring harness and mounting hardware • Clamshell packaged

PART #	DESCRIPTION	REPL. LENS (BULK)
OP800	39.02 (1) Light Kit (As Shown)	----
OP802	11.60 (1) Right Side Tail Light	Rear OP170, Side OP172
OP804	11.82 (1) Left Side Tail Light	Rear OP170, Side OP172

(1) 20' trailer harness & (1) license plate bracket

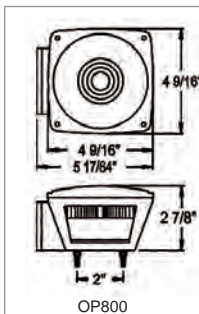

OP170	5.47
OP172	3.17

TRAILER



TRAILER LIGHT KITS

EACH ITEM SHOWN HERE CAN BE PURCHASED SEPARATELY

UNIVERSAL WATERPROOF OVER 80" AERO PRO TRAILER LIGHT KIT



PART #	DESCRIPTION	REPL. LENS (BULK)
OP360	67.37 (1) Light Kit (As Shown)	----
OP362	18.07 (1) Right Side Tail Light	Rear OP365, Side OP366
OP363	18.57 (1) Left Side Tail Light	Rear OP365, Side OP366
OP917	5.77 (2) Clearance Lights	----
OP250	24.87 (1) 25' Wire Harness (Wishbone)	----

(1) license plate bracket also included.

OP365	3.87
OP366	1.02

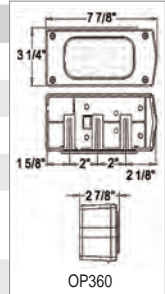

OP360

UNIVERSAL LOW PROFILE WATERPROOF OVER 80" TRAILER LIGHT KIT



Low profile • Includes 2 taillights • 2 amber side lights • License plate bracket • 25-ft. wiring harness • Stainless hardware • Clamshell packaged

PART #	DESCRIPTION	REPL. LENS (BULK)
OP160	67.87 (1) Light Kit (As Shown)	----
OP162	19.25 (1) Right Side Tail Light	Rear & Side OP169
OP164	19.72 (1) Left Side Tail Light	Rear & Side OP169
OP917	5.77 (2) Clearance Lights	----
OP250	24.87 (1) 25' Wire Harness (Wishbone)	----

(2) amber reflectors & (1) license plate bracket also included.

OP169	8.87
-------	------

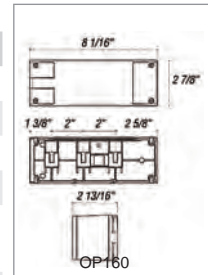

OP160

UNIVERSAL SUBMERSIBLE UNDER 80" TRAILER LIGHT KIT

Kit includes 2 submersible stud mount tail lights, two amber side markers and a corrosion proof license plate bracket • Retail packaged



PART #	DESCRIPTION	REPL. LENS (BULK)
OP501	48.80 (1) Light Kit (As Shown)	----
OP902	12.75 (1) Right Side Tail Light	Rear OP170, Side OP172
OP904	13.22 (1) Left Side Tail Light	Rear OP170, Side OP172
OP250	24.87 (1) 25' Wire Harness (Wishbone)	----

(2) amber clearance lights & (1) license plate bracket also included.

OP170	5.47
OP172	3.17

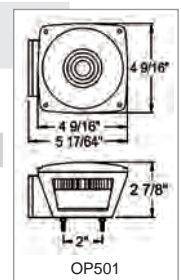

OP501

FAST SAME DAY SHIPPING

TRAILER CATALOG

81

tires & wheels
axles, hubs & springs
tongue accessories
hitches
electrical
brake parts
trailer hardware
locks & pins
towing & loading
tie downs
tools
chemicals

TRAILER



LED TRAILER LIGHT KITS

EACH ITEM SHOWN HERE CAN BE PURCHASED SEPARATELY



FEATURES:

- **EASE OF REPLACEMENT / RETROFIT** - Optronics **LED** market clearance lights utilize standard 2-wire molded plugs used for regular incandescent lighting. Our **LED** stop/turn/tail lights utilize standard 3-wire plugs. No special wires or plugs needed. retrofit with ease!
- **FULL 3 YEAR WARRANTY FROM DATE OF PURCHASE** - All Optronics **LED** lighting products are covered under a 3 year warranty. Optronics will repair or replace defective products.
- **NEW! SUPER DIODES** - Selected Optronics **LED** Stop / turn / tail lights manufactured using powerful Super Diodes - 3X as bright as standard diodes. In addition, super diodes offer almost twice the angle of light as standard diodes. A brighter **LED**!

WATERPROOF LED AEROPRO OVER 80" COMBINATION

TAIL LIGHT KIT



Universal mount stop/turn/tail lights. All- weather molded plastic housing. Kit includes 2 **LED** lights, 2-wire 25' wishbone wire harness, and 2 clearance lights. Clamshell packaged.

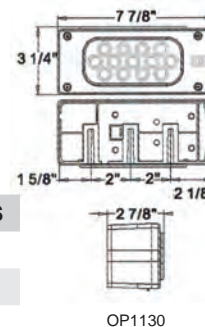

PART #	DESCRIPTION	DIODES	
OP1130	140.67	Light Kit (As Shown)	----
OP1136	47.35	6 Function LED Right Side Tail Light	17
OP1137	57.90	7 Function LED Left Side Tail Light	23
OP917	5.77	Clearance Lights	----
OP250	24.87	25' Wire Harness (Wishbone)	----

WATERPROOF OVER 80" COMBINATION LED TAIL LIGHT KIT



Universal mount stop/turn/tail lights. All- weather molded plastic housing. Kit includes 2 **LED** stud mount tail light with red side markers/reflectors, license bracket, 25-ft wiring and harness. Clamshell packaged.

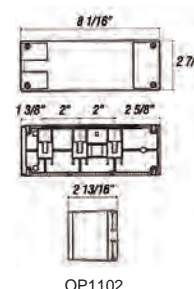

PART #	DESCRIPTION	DIODES	
OP1102	121.95	Light Kit (As Shown)	----
OP1114	51.72	6 Function LED Right Side Tail Light	18
OP1115	56.72	7 Function LED Left Side Tail Light	22
OP250	24.87	25' Wire Harness (Wishbone)	----

WATERPROOF UNIVERSAL UNDER 80" COMBINATION LED TAIL LIGHT KIT



Under 80" wide unit. Inc. 2 **LED** stud mounted tail lights with real side markers/reflectors, license bracket, 25-ft wiring harness. Clamshell packaged.

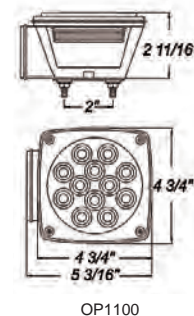

PART #	DESCRIPTION	DIODES	
OP1100	113.97	Light Kit (As Shown)	----
OP1110	46.72	6 Function LED Right Side Tail Light	16
OP1111	51.72	7 Function LED Left Side Tail Light	21
OP250	24.87	25' Wire Harness (Wishbone)	----

REPLACEMENT LENSES FOR ABOVE LIGHTS



- No bulbs to replace...EVER!
- Brighter than standard, conventional bulbs
- Side marker lights are built in
- 100% sealed, waterproof stop, turn, tail lights

PART #	DESCRIPTION	
OP460	5.87	Replacement Lens for OP1114
OP461	1.02	Replacement Lens for OP1115
OP462	3.20	Replacement Tail Light Lens for OP1110



TRAILER



TRAILER LIGHTING

LED COMBO UNDER 80" S/T/T LIGHTS

- Includes Light with chrome bezel
- Ideal use on boat trailers
- STI approved
- 9 Diode

PART #	MFG #	DESCRIPTION
989032	42.19	C7483RTM LED COMBO S/T/T DRIVER'S SIDE
989033	42.19	C7493RTM LED COMBO S/T/T PASSENGER'S SIDE



LED CLEAR LENS SUBMERSIBLE TRAILER LIGHT KIT

- Includes Complete kit
- Clear Lens with red LEDs
- Contents: 2 submersible stop/tail/turn LED lights, wiring harness, license plate bracket, mounting hardware and complete trilingual instructions
- Left hand side has 21 Diodes
- Right hand side has 16 Diodes

PART #	MFG #	DESCRIPTION
989034	108.49	C5721 SUBMERSIBLE KIT



LED LOW PROFILE TRAILER LIGHT KIT OVER/UNDER 80"

- Includes Complete kit
- 'TRY ME' Packaging
- Low profile design
- Contents: 2 submersible stop/tail/turn LED lights, wiring harness, license plate bracket, mounting hardware and complete trilingual instructions
- Left hand side has 14 Diodes
- Right hand side has 11 Diodes

PART #	MFG #	DESCRIPTION
989036	84.39	C7280 LOW PROFILE LIGHT KIT



LED TRAILER LIGHT KIT - SUBMERSIBLE - UNDER 80"

- Includes Complete kit
- 'TRY ME' Packaging
- Low profile design
- Contents: 2 submersible stop/tail/turn LED lights, wiring harness, license plate bracket, mounting hardware and complete trilingual instructions
- Left hand side has 14 Diodes
- Right hand side has 11 Diodes

PART #	MFG #	DESCRIPTION
989037	108.49	C7423 LED TRAILER LIGHT KIT



- tires & wheels
- axles, hubs & springs
- tongue accessories
- hitches
- electrical
- brake parts
- trailer hardware
- locks & pins
- towing & loading
- tie downs
- tools
- chemicals

TRAILER



TRAILER LIGHT KITS

UNIVERSAL LOW PROFILE SUBMERSIBLE OVER 80" WIDE

TRAILER LIGHT KIT



Over 80" submersible rear lighting kit for all trailers - includes rear legal tail lighting and reflectors for trailers over 80" wide (PM456/4561 tail light) 25' trailer harness, 48" trunk connector, license bracket, mounting hardware. NOTE: front side lights, reflectors, rear I.D. bar are necessary to meet DOT requirements.

PART #	MFG #	DESCRIPTION
PM547	68.93 V547	Submersible Light Kit

REPLACEMENT PARTS FOR PM547		
PM456	23.10 M456	7-Way Tail Light RH
PM4561	23.95 M456L	8-Way Tail Light LH
PM5425	28.58 V5425Y	25' Wire Harness

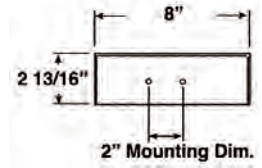

UNIVERSAL SUBMERSIBLE OVER 80" WIDE TRAILER LIGHT KIT

Kit provides rear lighting and reflectors for trailers over 80" wide. Includes 2 tail lights, 25' trailer harness, 48" trunk connector, license bracket, mounting hardware, and installation instructions.



PART #	MFG #	DESCRIPTION
PM544	59.74 V544	Submersible Light Kit

REPLACEMENT PARTS FOR PM544		
PM452	20.06 V452	7-Way Tail Light RH
PM4521	21.43 V452L	8-Way Tail Light LH
PM5425	28.58 V5425Y	25' Wire Harness
PM44015	4.38 440-15	Repl Rear Lens
PM5615	4.96 55-15R	Repl Side Lens

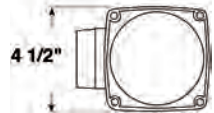
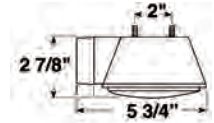

UNIVERSAL UNDER 80" WIDE TRAILER LIGHT KIT

This kit provides all legal lighting and reflective equipment for any trailer less than 80" wide. It includes 2 tail lights, 20' wire harness, 2 side marker lights, 48" trunk connector, plastic license bracket, mounting hardware, and installation instructions.



PART #	MFG #	DESCRIPTION
PM540	53.61 V540	Trailer Light Kit

REPLACEMENT PARTS FOR PM540		
PM440	12.82 V440	7-Way Taillight RH
PM444	12.79 V440L	8-Way Tail Light LH
PM114	6.59 V114A	Clearance Light
PM5425	28.58 V5425Y	25' Wire Harness
PM44015	4.38 440-15	Repl Rear Lens
PM5515	4.98 55-15R	Repl Side Lens - Red
PM5516	4.98 55-15A	Repl Side Lens - Amber

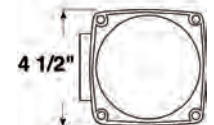
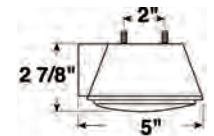

REPLACEMENT TAIL LIGHTS & LENSES



MN9091 LENS ONLY



MN9090 LENS ONLY

PART #	MFG #	DESCRIPTION
MN5236	23.95 52362-3	LH Tail Light Assembly
MN5237	23.95 52372-3	RH Tail Light Assembly
GE1034	0.50 1157	Replacement Rear Bulb
GE1895	0.50 57	Replacement Side Bulb

- WRAP AROUND • 5-IN-1 TAIL LAMP
- STOP-TAIL-TURN • SIDE MARKER REFLECTOR

Red Replacement Lenses for MN5236 and MN5237 tail lights. Combination rear lamp for in-frame mounting - as used on many trailers: snowmobile, utility, etc.

TRAILER



TRAILER LIGHTING

- tires & wheels
- axles, hubs & springs
- tongue accessories
- hitches
- electrical
- brake parts
- trailer hardware
- locks & pins
- towing & loading
- tie downs
- tools
- chemicals

TRAILER



4.5" x 4.5" LED ROUND UTILITY FLOOD LIGHT
989002 52.69

4.25" x 4.25" LED SQUARE UTILITY FLOOD LIGHT
989003 47.59

FLOOD LIGHT

- 8 3 W high performance LEDs
- 930 effective /1560 raw lumens
- 1.3 amps
- Die cast aluminum housing
- Works with 12-24 volt systems
- Adjustable mounting bracket
- IP-67 rating: weatherproof



4.5" x 2.5" LED RECTANGULAR UTILITY FLOOD LIGHT
989004 52.49

FLOOD LIGHT

- 6 3W high performance LEDs
- 630 effective/1200 raw lumens
- 0.9 amps
- Die cast aluminum housing
- Works with 12-24 volt systems
- Adjustable mounting bracket
- IP-67 rating: weatherproof



5" x 2" LED RECTANGULAR WORK LIGHT
989005 79.79

FLOOD LIGHT

- 4 5W high performance LEDs
- 950 effective/2000 raw lumens
- 1.65 amps
- Die cast aluminum housing
- High impact polycarbonate lens
- Works with 12-24 volt systems
- Adjustable mounting bracket
- IP-67 rating: weatherproof



2" x 2" LED FLOOD LIGHT
989006 79.69

FLOOD LIGHT

- 4 5W high performance LEDs
- 880 effective/1920 raw lumens
- .075 - 1.5 amps
- Die cast aluminum housing
- High impact polycarbonate lens
- Works with 12-24 volt systems
- Adjustable mounting bracket
- IP-67 rating: weatherproof



4" LED LIGHT
989007 78.49

FLOOD LIGHT

- 6 3W high performance LEDs
- 740 effective/1200 raw lumens
- 1.75 amps
- Die cast aluminum housing
- High impact polycarbonate lens
- Works with 12-24 volt systems
- Adjustable mounting bracket
- IP-67 rating: weatherproof



7" LED LIGHT
989008 105.99

FLOOD/SPOT LIGHT

- 12 3W high performance LEDs
- 1900 effective/2500 raw lumens
- 2.4 amps
- Die cast aluminum housing
- High impact polycarbonate lens
- 10.75" with adjustable mounting bracket
- IP-67 rating: weatherproof

MAGNETIC WORK LAMP

12' POWER CORD, FLOOD BEAM

4" SQUARE WORK LAMP
989041 48.95

- Includes Light and Installation Kit
- Aluminum die-case housing and polycarbonate lens
- Five 3W high output LEDs
- 12' 12 volt power cord, and magnetic base



LED LOW PROFILE MAGNETIC MOUNT STROBE/BEACON LIGHT

- 32 amber LED
- Polycarbonate lens for superior performance in all weather conditions
- Change among 8 flash patterns with just a push of a button
- Heavy-duty magnetic base
- LED provides lower current draw compared to traditional incandescent and halogen bulbs
- Includes 12 ft. power cord, plug with on/off switch

PART #	MFG #	DESCRIPTION
989040	108.19 C38CAW	LED LOW PROFILE STROBE



FAST SAME DAY SHIPPING



TRAILER LIGHTING

- tires & wheels
- axles, hubs & springs
- tongue accessories
- hitches
- electrical
- brake parts
- trailer hardware
- locks & pins
- towing & loading
- tie downs
- tools
- chemicals

LED LIGHT BARS



5,000 raw lumens

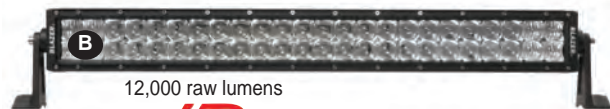

12,000 raw lumens



15,000 raw lumens



23,000 raw lumens



A	14" LED LIGHT BAR	24 3W High Performance LEDs	---	989009	164.59
B	24" LED LIGHT BAR	48 2W High Performance LEDs	8 amps	989010	270.09
C	36" LED LIGHT BAR	72 2W High Performance LEDs	10 amps	989011	397.99
D	52" LED LIGHT BAR	100 2W High Performance LEDs	10 amps	989012	508.39

- Die cast aluminum housing
- Durable for multiple uses
- Heavy duty brackets for secure mount
- High impact polycarbonate lens
- IP-67 rating: weatherproof
- Dual-chip technology for higher lumens

SINGLE ROW LED LIGHT BARS



7,000 raw lumens



8,500 raw lumens



12,000 raw lumens



- Die cast aluminum housing
- High-impact polycarbonate lens
- Adjustable mounting bracket
- IP-67 rating: weather proof
- Dual-chip technology for higher lumens

E	24" SINGLE ROW LED LIGHT BAR	24 2W High Performance LEDs	4 amps	989016	175.19
F	36" SINGLE ROW LED LIGHT BAR	36 2W High Performance LEDs	6 amps	989017	238.49
G	52" SINGLE ROW LED LIGHT BAR	50 2W High Performance LEDs	8 amps	989018	319.19

TRAILER

LED WORK/UTILITY LIGHTS

989022	37.29	LED 4" Round High Output Utility/Work Light Cast Aluminum Hsng
--------	-------	--



989022

LED STROBE EMERGENCY LIGHTS

989019	28.79	LED Beacon - Magnetic Base
989024	196.89	LED Class II Warning Light Bar - Magnetic Base
989020	137.09	LED Mini Light Bar - Magnetic Base
989021	124.69	LED Mini Light Bar - Magnetic Base - Clear Lens

LED CLEARANCE/MARKER LIGHTS

989013	6.09	LED 3/4" Amber Clearance Marker Light - Display Pack
989014	6.09	LED 3/4" Red Clearance Marker Light - Display Pack
989015	36.19	LED Fender Light Kit - Right Hand & Left Hand Display Pack



LED MARKER / CLEARANCE LIGHTS

LED 2" ROUND SEALED MARKER/CLEARANCE LIGHTS

- Multiple diode **LED** clearance or side marker light features sonically sealed, waterproof lens and housing in a single unit
- Complete with grommet and plug

PART #	MFG #	DIODES	COLOR	PACKAGING	
OP557	17.52	ML-55AK	4 Diodes	Amber	Clamshell
OP556	15.68	MCL-55RK	3 Diodes	Red	Clamshell



LED 2.5" ROUND SEALED MARKER/CLEARANCE LIGHTS

- Multiple diode **LED** clearance or side marker light features sonically sealed, waterproof lens and housing in a single unit
- Complete with grommet and plug

PART #	MFG #	DIODES	COLOR	PACKAGING	
OP577	18.90	MCL-57AK	4 Diodes	Amber	Clamshell
OP576	16.90	MCL-57RK	3 Diodes	Red	Clamshell

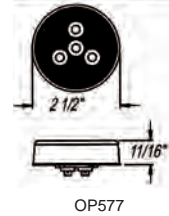

LED THIN LINE SEALED MARKER/CLEARANCE LIGHTS

- 6 diode **LED** clearance or side marker light features sonically sealed, waterproof lens and housing in a single unit
- Complete with base and plug assembly

PART #	MFG #	DIODES	COLOR	PACKAGING	
OP676	16.20	MCL-67RK	6 Diodes	Red	Clamshell

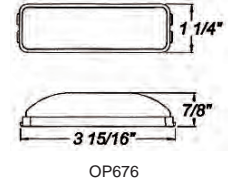

LED MINI THIN LINE SEALED MARKER/CLEARANCE LIGHTS

- 6 diode **LED** clearance or side marker light features sonically sealed, waterproof lens and housing in a single unit
- Complete with base and plug assembly (see page 61 for replacement)

PART #	MFG #	DIODES	COLOR	PACKAGING	
OP915	12.52	MCL-91AK	3 Diodes	Amber	Clamshell
OP916	12.52	MCL-91RK	3 Diodes	Red	Clamshell

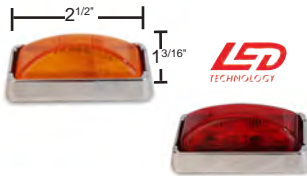
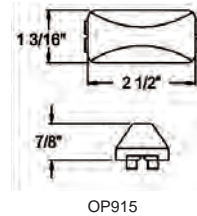

LED SEALED 3 PIECE IDENTIFICATION LIGHT BAR

- A **LED** ID light bar features all-weather molded plastic housing and durable lens to protect against corrosion
- Watertight connection to the electrical harness

PART #	MFG #	DIODES	COLOR	PACKAGING	
OP936	36.45	MCL-93RK	9 Diodes	Red	Carded

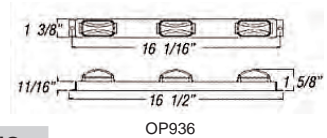

LED SEALED 3 PIECE IDENTIFICATION LIGHT BAR

- Sealed stainless **LED** ID light bar for over 80" applications
- Watertight connection to the electrical harness
- Features sonically sealed, waterproof light capsules

PART #	MFG #	DIODES	COLOR	PACKAGING	
OP938	37.60	MCL-97RK	9 Diodes	Red	Carded

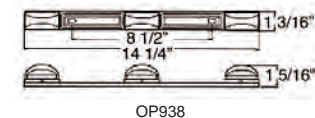

tires & wheels
axles, hubs & springs
tongue accessories
hitches
electrical
brake parts
trailer hardware
locks & pins
towing & loading
tie downs
tools
chemicals

TRAILER



LIGHT BARS



SEALED SUBMERSIBLE "ID" LIGHT BAR FOR OVER 80" APPLICATIONS

• Submersible identification bar light for over 80" applications • Black polycarbonate bar is corrosion-proof with three 150 sealed lights attached • 150 Lights snap on/off for easy service • Mounts on 16" centers • Includes three-plug harness with two lead wires.

PART #	MFG #	DESCRIPTION
PM1503	21.07 150-3R	Bar w/3 Lights - Amber
PM150	7.38 V150R	Replacement Light - Red

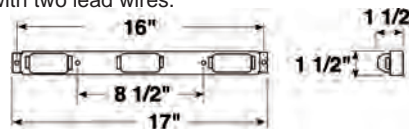

THIN LINE "ID" LIGHT BARS FOR OVER 80" APPLICATIONS

• Identification bar light for over-80" applications • Corrosion resistant bar is 24-gauge steel with black enamel finish and three 136 oval lights attached • Mounts on 6-15/16" centers • Includes single lead wire, and grounds through mounting hardware • Available in amber or red.

PART #	MFG #	DESCRIPTION
PM13650	15.95 136-3A	Amber Light Bar
PM13660	17.86 136-3R	Red Light Bar
PM136	6.86 V136A	Light Only - Amber
PM1361	6.86 V136R	Light Only - Red
PM1365	3.26 136-15A	Replacement Lens - Amber
PM1366	3.26 136-15R	Replacement Lens - Red
GE194	0.50 194	Replacement Bulb

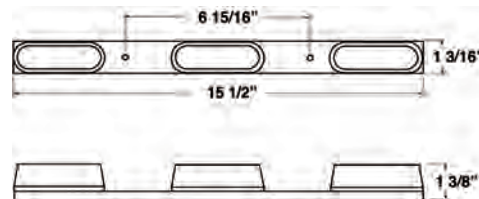

MINI "ID" LIGHT BAR FOR OVER 80" APPLICATIONS

• Economical identification bar light for over 80" applications • Corrosion-resistant bar is power-coated white with three 107 lights attached • Mounts on 16-1/8" centers and grounds through mounting hardware • Available in red only.

PART #	MFG #	DESCRIPTION
PM1073	16.92 107-3R	Red Light Bar
PM1070	5.51 V107WR	Light Only - Red
PM7150	3.23 107-15R	Replacement Lens Only
GE194	0.50 194	Replacement Bulb



MARKER/CLEARANCE LIGHTS



CLEARANCE/SIDE MARKER LIGHTS FENDER MOUNT #40 SERIES

Dual function red/amber light for use on fender mount applications. The bulb is protected by the lens on all sides. Two wire design (24" supply and ground) eliminates surface ground. Light w/black base, stainless steel mounting screws: 3.65" x 1.25" x 1.45" w/.5" depth. Light only: 2.75" x 1" x .85" w/.5" depth. Fender mount bezel only: 7.20" x 4.85" x .85".

PART #	MFG #	DESCRIPTION
444297	12.56 40-40-104	Fender Mount Clearance Light #40 Red/Amber
444298	3.78 40-40-115	Fender Mount Bezel

WATERPROOF LED HI INTENSITY MICRO CLEARANCE/SIDE MARKER LIGHTS



Waterproof Hi Intensity LED clear, red and amber micro clearance/side marker light. The red and amber lights are FMVSS-108 PC rated. The clear style is ideal for auxiliary and decorative lighting. Self contained grommet and pre-wired with sealed 7" wire pigtail. .75" light dia. x .5" height, 1" dia. w/grommet. Note: Recommended hole size is .75" and the recommended material thickness is between .0625" and .125".

PART #	MFG #	DESCRIPTION
444293	5.94 54201-003	Hi Intensity Micro Clearance Light LED Amber
444294	5.94 54201-004	Hi Intensity Micro Clearance Light LED Red
444295	5.40 54201-005	Hi Intensity Micro Light LED Clear

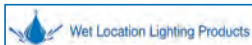

TRAILER

MARKER/CLEARANCE LIGHTS



SQUARE REFLECTOR MARKER/CLEARANCE LIGHTS

Square clearance or side marker light with a reflectorized lens, eliminating the need for a separate reflector to meet DOT requirements. Single wire design grounds through mounting stud. Replaceable lens and easy to change replaceable bulb (#GE194). All-weather molded plastic housing and durable lens to protect against corrosion. Amber or red. Available in colorful retail packaging.

PART #	MFG #	DESCRIPTION
OP367	5.77 MC-36AS	Amber
OP368	5.30 MC-36RS	Red

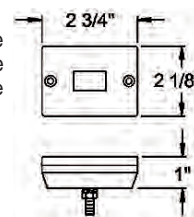

SEALED RECTANGULAR MARKER/CLEARANCE LIGHTS

Mini thin-line rectangular clearance or side marker light. PC-Rated light that functions as both a clearance and side marker light when properly mounted on a 45 degree angle. Features sonically sealed, waterproof lens and housing in a single unit. MC-91 kits include the A-91 light and A-91CB chrome base.

PART #	MFG #	DESCRIPTION
OP917	5.77 MC-91AS	Amber
OP918	5.77 MC-91RS	Red

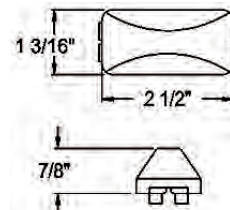

DOUBLE BULLSEYE MARKER/CLEARANCE LIGHTS

Dual bulb, bullseye marker/clearance light with black base. Two-bulb design optimizes light output. Features snap-on, replaceable lens and easy to change replaceable bulbs (#GE194). All-weather molded plastic housing and durable lens protect against corrosion. Mounts on industry standard 3" centers. Amber or red. Available in colorful retail packaging.

PART #	MFG #	DESCRIPTION
OP470	4.90 MC-42AS	Amber
OP471	4.90 MC-42RS	Red

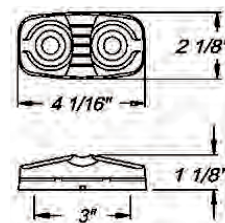

2.5" ROUND SIDE MARKER/CLEARANCE LIGHTS

Round clearance or side marker light for surface mount. PC-Rated light that functions as both a clearance and side marker light when properly mounted on a 45 degree angle. All-weather molded plastic housing and durable lens protect against corrosion. Single wire design grounds through mounting hardware. Features snap-on, replaceable lens and easy to change replaceable bulb (#GE194). Amber or red. Available in colorful retail packaging.

PART #	MFG #	DESCRIPTION
OP472	4.40 MC-58AS	Amber
OP473	4.40 MC-58RS	Red

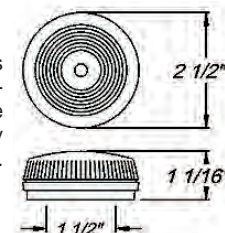

OBLONG REFLECTOR MARKER/CLEARANCE LIGHTS

- Oblong clearance or side marker light with reflectorized lens, which meets DOT requirements
- Ear-mount black base
- All weather molded plastic housing to protect against corrosion

PART #	MFG #	DESCRIPTION
OP377	4.40 MC-31AS	Amber
OP378	4.40 MC-31RS	Red

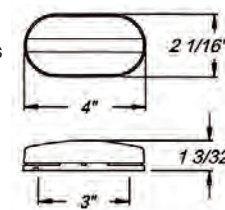

SEALED STUD MOUNT MARKER/CLEARANCE LIGHTS

- Stud mount clearance or side marker light features sonically sealed, waterproof lens and housing in a single unit
- Single wire design grounds through mounting stud

PART #	MFG #	DESCRIPTION
OP385	5.55 MC-95AS	Amber
OP386	5.55 MC-95RS	Red

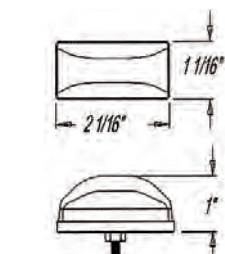

tires & wheels

axles, hubs & springs

tongue accessories

hitches

electrical

brake parts

trailer hardware

locks & pins

towing & loading

tie downs

tools

chemicals

TRAILER

MARKER/CLEARANCE LIGHTS

- tires & wheels
- axles, hubs & springs
- tongue accessories
- hitches
- electrical
- brake parts
- trailer hardware
- locks & pins
- towing & loading
- tie downs
- tools
- chemicals

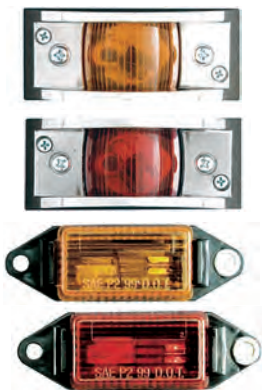

CHROME PLATED MARKER/CLEARANCE LIGHTS

- Clearance or side marker light features snap-on, replaceable lens
- Single wire design grounds through mounting hardware

PART #	MFG #	DESCRIPTION
OP383	6.33	MC-81AS Amber

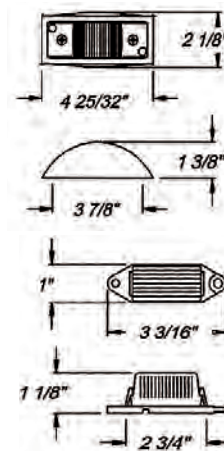

MINI MARKER/CLEARANCE LIGHTS

- Mini rectangular light with durable plastic base with external mounting holes
- Single wire design grounds through mounting screw

PART #	MFG #	DESCRIPTION
OP370	3.45	MC-11AS Amber
OP371	3.18	MC-11RS Red



RECTANGULAR REFLECTOR MARKER/CLEARANCE LIGHTS

- Rectangular clearance or side marker light with reflectorized lens, which meets DOT requirements
- Ear-mount black base
- All weather molded plastic housing to protect against corrosion

PART #	MFG #	DESCRIPTION
OP373	6.02	MC-35AS Amber

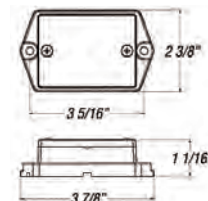

FLUSH MOUNT MARKER/CLEARANCE LIGHTS

- Flush mount clearance or side marker light with chrome trim
- Design includes both lead and ground wires for mounting to all surfaces

PART #	MFG #	DESCRIPTION
OP380	6.27	MC-71AS Amber
OP381	5.75	MC-71RS Red

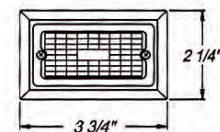

ELEVATED MARKER/CLEARANCE LIGHT ASSEMBLIES WITH REFLEX

- Kit includes surface mount bracket with sealed marker light and reflector
- PC-Rated light fulfills P2 function when properly mounted on a 15° angle

PART #	MFG #	DESCRIPTION
OP388	6.68	MC-61RB Amber

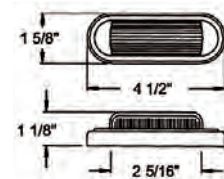

OBLONG CLEARANCE/SIDE MARKER LIGHTS

- Thin-line, surface-mount lamp features high impact base with scratch resistant acrylic lens
- May be mounted horizontally or vertically
- Includes single lead wire and grounds through mounting screw
- Available in amber or red

PART #	MFG #	DESCRIPTION
PM136	6.86	V136A Light Only - Amber
PM1361	6.86	V136R Light Only - Red
PM1365	3.26	136-15A Lens Only - Amber
PM1366	3.26	136-15R Lens Only - Red

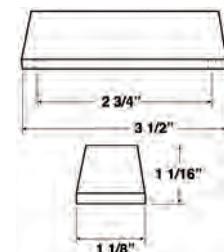

2" CLEARANCE AND SIDE MARKER LIGHT

- Functions as side marker or clearance light
- May be used as combination side marker and clearance light when properly mounted
- Features sealed lens and housing
- Light comes without flange for use with rubber grommet
- Requires 2-wire plug to complete installation
- Features 15,000-hour long life bulb
- Kit includes grommet (# PM14618) and plug (# PM14249)
- Available in amber or red

PART #	MFG #	DESCRIPTION
PM1461	6.00	146A Amber Light
PM146	6.00	146R Red Light
PM14618	3.55	146-18 Grommet Only
PM14249	5.93	142-49 Plug Only

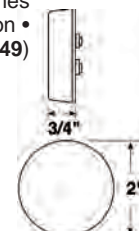

TRAILER



CLEARANCE & SIDE MARKER LIGHTS

tires & wheels

axles, hubs & springs

tongue accessories

hitches

electrical

brake parts

trailer hardware

locks & pins

towing & loading

tie downs

tools

chemicals

TRAILER

CLEARANCE/SIDE MARKER LIGHT W/REFLEX

• Stud-mount light functions as side marker or clearance light with built-in reflective optics; eliminates need for separate reflector • Just push stripped power into "Quick Lock" port to connect • May be used as a combination side marker and clearance light for over 80" applications when properly mounted • Features 15,000-hour long life bulb • Available in amber or red

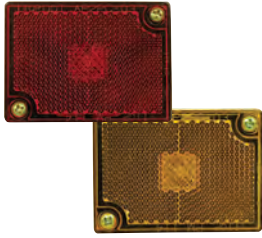

PART #	MFG #	DESCRIPTION
PM114	6.59 V114A	Amber Light
PM1141	6.59 V114R	Red Light
PM1140	3.64 114-15A	Amber Replacement Lens
PM1145	3.64 114-15R	Red Replacement Lens
GE194	0.50 194	Replacement Bulb

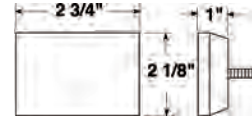

DOUBLE BULLS-EYE CLEARANCE AND SIDE MARKER LIGHT

• Popular, two-bulb lamp that functions as clearance or side marker light, and may be used as combination clearance and side marker when properly mounted • Acrylic lens snaps onto housing Surface mounts on 3" centers and grounds through mounting hardware; single wire for electrical connection • Features two 15,000-hour long life bulbs • Available in amber or red



PART #	MFG #	DESCRIPTION
PM1381	6.20 V138A	Amber Light
PM138	7.46 V138R	Red Light
PM1385	5.46 V138-15A	Amber Replacement Lens
PM1380	5.50 V138-15R	Red Replacement Lens
GE194	0.50 194	Replacement Bulb



COMBINATION 1-BULB LIGHT W/REFLEX

• Acrylic lens features built-in reflector and precision optics for brilliant signal; no separate reflector needed • Includes durable, molded base with single-bulb socket and single lead wire; grounds through mounting screw • Available in amber or red.



PART #	MFG #	DESCRIPTION
PM1081	6.21 108WA	Amber Light
PM108	6.21 108WR	Red Light
PM10816	3.36 108-15A	Amber Replacement Lens
PM10815	3.36 108-15R	Red Replacement Lens
GE194	0.50 194	Replacement Bulb

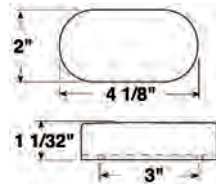

MINI-LITES (EAR MOUNT)

• Amber or red lights functions as clearance, side marker or identification light and may be used as combination side marker and clearance light when properly mounted • Features durable base with external mounting holes • Lens snap-locks onto base • Includes single lead wire and grounds through mounting screw.



PART #	MFG #	DESCRIPTION
PM1070	5.51 V107WR	Light Only - Red
PM1071	5.51 V107WA	Light Only - Amber
PM7150	3.23 107-15R	Lens Only - Red
PM7151	3.23 107-15A	Lens Only - Amber
GE194	0.50 194	Replacement Bulb

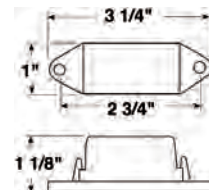

SEALED CLEARANCE AND SIDE MARKER LIGHTS

Functions as side marker or clearance light • When mounted at a 45 degree angle, light may be used as combination clearance and side marker • Lens is welded to housing to form single unit • Mounting screw serves as ground when mounted to metallic surface with single lead wire for electrical connection • Features two 15,000-hour long life bulbs • Available in amber or red.



PART #	MFG #	DESCRIPTION
PM154	5.91 154A	Light Only - Amber
PM155	5.91 154R	Light Only - Red
PM15409	8.78 154-09K	Bracket - Gray
PM15410	7.59 154-10K	Bracket - Chrome
PM15411	8.75 154-11K	Bracket - Black

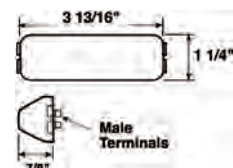



BACK-UP LIGHTS

SEALED OVAL BACK-UP LIGHT

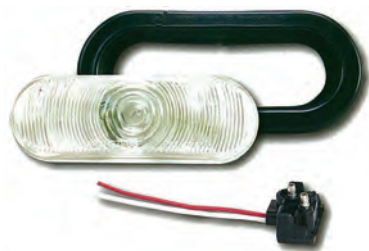

• Sealed, oval back-up light meets DOT requirement in either horizontal or vertical position • Polycarbonate lens is sonic welded to housing to form single unit • Kit includes light, grommet (# **PM42118**), and plug (# **PM14249**)

PART #	MFG #	DESCRIPTION
PM4165	19.32 416K	Clear Light Kit
PM42118	5.74 421-18	Grommet Only
PM14249	5.93 142-49	Plug Only

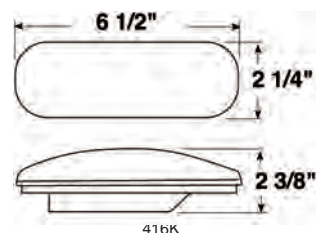

SEALED ROUND 4" BACK-UP LIGHT

• Features extra wide, spin-welded, tongue-and-groove lens lip and waterproof seal • High performance, copper alloy conductors eliminate the possibility of wire failure • State-of-the-art bulb design features three supports for the minor filament and two supports for the major filament providing long bulb life • Wedge-base socket prevents premature bulb failure • Kit includes light, grommet (# **PM42618**) and plug (# **PM43149**)

PART #	MFG #	DESCRIPTION
PM415	18.30 415K	Clear Light Kit
PM42618	5.58 426-18	Grommet Only
PM43149	6.12 431-49	Plug Only

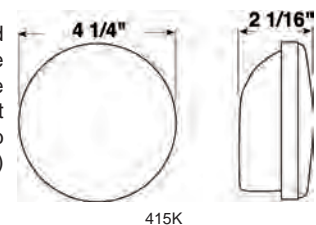

REFLECTORS



SPITFIRE® REFLECTOR KIT

50% wider reflectivity angle than conventional reflectors. Kit contains 2 each round 2-7/8" diameter, 2 each rectangular 2-3/4" x 1-1/4", 2 each rectangular 4-5/16" x 1-11/16", all red, in attractive, self-service visual packaging.

PART #	MFG #	DESCRIPTION
PM493	9.95 V493KR	Spitfire Reflector Kit



RECTANGULAR REFLECTORS

Acrylic rectangular reflectors for surface mount. Self-adhesive and screw mount.

PART #	MFG #	DESCRIPTION
OP221	4.05 RE-15AK	Amber Reflector
OP222	4.05 RE-15RK	Red Reflector

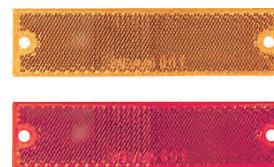
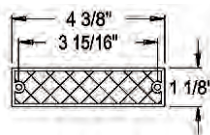

OBLONG REFLECTORS

Acrylic oblong reflectors for surface mount. Self-adhesive and screw mount.

PART #	MFG #	DESCRIPTION
OP127	4.05 RE-12AK	Amber Reflector
OP128	4.05 RE-12RK	Red Reflector

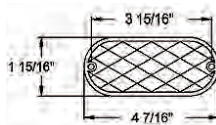

3-3/16" ROUND REFLECTORS

Round acrylic reflectors for surface mount. Self-adhesive.

PART #	MFG #	DESCRIPTION
OP217	2.05 RE-21AS	Amber Reflector
OP218	2.05 RE-21RS	Red Reflector

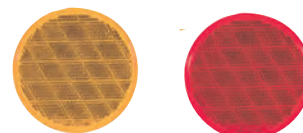

STROBE LAMPS & TOWING LIGHT KITS

- tires & wheels
- axles, hubs & springs
- tongue accessories
- hitches
- electrical
- brake parts
- trailer hardware
- locks & pins
- towing & loading
- tie downs
- tools
- chemicals



2 JOULE SINGLE FLASH STROBE BEACON
60 FLASHES PER MINUTE

- 12 volt • Single flash with fresnel lens • 2 joule / 150 candela per second brightness
- Shock-resistant rubber base, encapsulated circuitry • Magnetic-mount model is equipped with 15' coil cord and lighter socket plug with built-in on/off switch and LED indicator

PART #	MFG #	DESCRIPTION
PM769	132.47 769A	Boxed

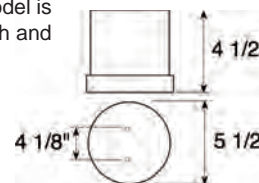

MICRO-STROBE LIGHT 78 FLASHES PER MINUTE

A compact, low-profile flashing strobe light. Unit features a polycarbonate lens and a bright two-joule (2.6 watt/sec) flash. A threaded screw -on lens with O-ring seal offers water resistant performance. Complete with magnetic base and a 12 foot coiled cord that plugs into the cigarette lighter.

PART #	MFG #	DESCRIPTION
PM766	97.95 V766MA	Viz Pack

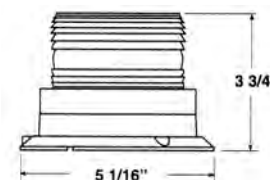

ALTERNATING FLASHING BEACON STROBE LIKE FLASHING

Unique design features two bulbs for maximum performance. Alternating strobe light action produces bursts of light for increased visibility. 3 powerful magnets and a 12 foot coiled cord with cigarette lighter plug. 12 volt only. Sold each.

PART #	MFG #	DESCRIPTION
PM7731	52.32 V773A	Viz Pack

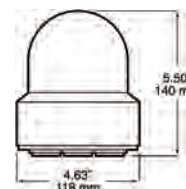

HIGH VISIBILITY STROBE LIGHTS

Buyers Strobe Lights feature a replaceable "U" shaped flash tube rated at 1.7 joules, and multi-volt operation (12-110V). Choose from permanent-mount or magnetic-mount. Magnetic-mount comes with self-coiled cord and cigarette plug adapter. Approx. dimensions: 6" dia. x 4-3/4" h.

PART #	MFG #	DESCRIPTION
BY650A	66.38 SL650A	Boxed



MAGNETIC MOUNT REVOLVING SAFETY LIGHT

The 12-volt teardrop light is ideal for use on vehicles where a permanent-mount light is not possible. The magnetic base secures the light while in operation, and allows you to remove the light when not in use. This revolving light comes with a 10' coiled power cord, cigarette plug adapter and a backup replacement bulb. Approx. dimensions: 7" base dia. x 5 1/4" h.

PART #	MFG #	DESCRIPTION
BY650	27.20 RL650A	Boxed

STROBE LAMPS & TOWING LIGHT KITS



LED WIRELESS TOWING LIGHT KIT

- Includes complete kit
- Effective transmitter distance of 65'
- Contents: 2 stop/tail/turn LED lights, transmitter with standard flat 4 wire vehicle trailer light connector and complete trilingual instructions
- 10 Diodes per light
- Patent Pending



PART #	MFG #	DESCRIPTION
989035	157.59	C5721 SUBMERSABLE KIT



HEAVY DUTY TOWING LIGHT SET

This light set offers quick and easy installation/removal with a sturdy magnetic base. A durable 30' cord with 4-pole spring plug easily activates turn signal, brakes and tail lights. Visible for up to one mile. Includes plastic storage case.



PART #	MFG #	DESCRIPTION
BY257	95.36	TL257M Boxed



TOWING LIGHT KIT

Strong magnetic base allows placement of lights on any auxiliary towing application. 20' four wire harness plugs into standard flat 4 wire connector. Kit includes 2 lights, wire harness and instructions.

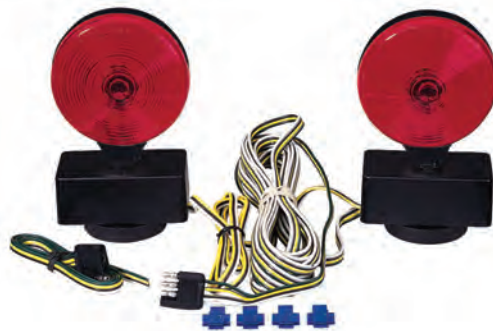

PART #	MFG #	DESCRIPTION
PM555	69.80	V555 Boxed

TRAILER

SEE ORDERING DIFFERENTLY:

Various Ordering Options
 Convenient 24/7 On-Line Management
 An Extensive Inventory

Same day and
 Saturday Shipping

**AUTOMATIC
 DISTRIBUTORS**

www.autodist.com



SPECIALTY LIGHTING



NIGHTWATCHER® LX CLEAR OE-STYLE FOG LIGHT



• Popular original equipment style clear driving light kit • Designed to mount in most factory and aftermarket air dams • Can be mounted on top or bottom of bumper • 55-watt halogen bulb • Black plastic housing • Replaceable, hardened-glass lens • Kit contains two lights, rocker switch, wiring, and installation instructions

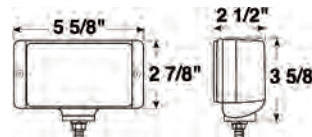

PART #	MFG #	DESCRIPTION
PM5661	71.01	V566-1 Viz Pack



NIGHTWATCHER® LX ULTRA-SLIM CLEAR FOG LIGHT



• Low profile clear fog light provides wide, low beam for better vision of the road ahead and cuts through rain, mist and snow • 55-watt halogen bulb • Ion-coated lens • Black metal housing • Mounts above or below bumper • Kit contains two lights, rocker switch, wiring, and installation instructions

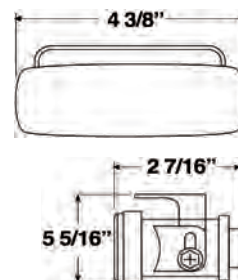

PART #	MFG #	DESCRIPTION
PM5562	54.95	V5562-2 Viz Pack



UTILITY-DOCK FLOOD LIGHT



Includes two quality halogen 55W lights, rubber bracket boots, safety-fused wiring harness and lighted switch. Black ABS housing.

PART #	MFG #	DESCRIPTION
OP16	46.47	DL-16CC Clamshell Pack



6" ROUND OFF-ROAD LIGHT



• 6" light produces over 250,000 candle power • Durable steel housing finished in black E-coat for long-lasting service • Aluminum-coated metal reflector • Hardened-glass lens • H3 100-watt halogen bulb • Armored cables • Universal swiveling, rubber cushioned mounting bracket • For off-road use only

PART #	MFG #	DESCRIPTION
PM530	77.58	V530 Viz Pack

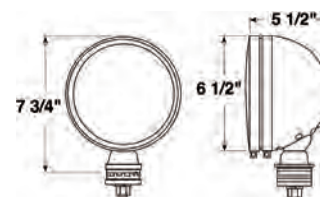

6" CHROME OFF-ROAD LIGHT

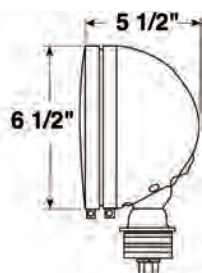

- 6" light produces over 250,000 candle power
- Durable chrome plated steel housing
- Aluminum-coated metal reflector
- Hardened-glass lens
- H3 100-watt halogen bulb
- Armored cables
- Universal swiveling, rubber cushioned mounting bracket
- For off-road use only

PART #	MFG #	DESCRIPTION
PM531	48.95	V531 Viz Pack

tires & wheels
axles, hubs & springs
tongue accessories
hitches
electrical
brake parts
trailer hardware
locks & pins
towing & loading
tie downs
tools
chemicals

TRAILER

- tires & wheels
- axles, hubs & springs
- tongue accessories
- hitches
- electrical
- brake parts
- trailer hardware
- locks & pins
- towing & loading
- tie downs
- tools
- chemicals

TRAILER

WesBarg LED WORK LIGHTS



LED work lights perfect for exterior use in AG, horse, livestock, RV, industrial and racing applications. Environmentally sealed design with aluminum housing and stainless steel mounting stud. High power, true white 9-36V, 10W light emission. Rectangular version with 10 LED diodes, circular model has 6 LED diodes.

Circular: 4.5" dia. x 1.5" depth
 Rectangular: 4" x 4" x 1.5" depth

PART #	MFG #	DESCRIPTION
444301	144.14 54209-001	Circular LED Light, 6 Diodes
444302	156.75 54209-002	Rectangular LED Light, 10 Diodes
444303	95.95 54209-003	Rectangular LED Light, 10 Diodes w/ Molded 2-Way Plug

WesBarg CIRCULAR LED WORK LIGHT WITH COILED CORD & MAGNETIC BASE



LED work lights perfect for exterior use in AG, horse, livestock, RV, industrial and racing applications. Environmentally sealed design with 19' extended coiled cord. Magnetic base, with protective film, secures in high vibration conditions in a vertical or horizontal position. Power adapter for 12V outlet with separate on/off switch. High power, true white 9-36V, 10W light emission. Circular version with 10 LED diodes, circular model has 6 LED diodes.

Circular: 4.5" dia. x 1.875" depth

PART #	MFG #	DESCRIPTION
928582	168.52 54209-017	Circular LED Work Light w/Magnetic Base

WesBarg RECTANGULAR LED WORK LIGHT WITH COILED CORD & MAGNETIC BASE



LED work lights perfect for exterior use in AG, horse, livestock, RV, industrial and racing applications. Environmentally sealed design with 19' extended coiled cord. Magnetic base, with protective film, secures in high vibration conditions in a vertical or horizontal position. Power adapter for 12V outlet with separate on/off switch. High power, true white 9-36V, 10W light emission. Rectangular version with 10 LED diodes, circular model has 6 LED diodes.

Rectangular: 4" x 4" x 1.75" depth

PART #	MFG #	DESCRIPTION
928583	180.86 54209-018	Rectangular LED Work Light w/Magnetic Base

SPECIALTY LIGHTING

- tires & wheels
- axles, hubs & springs
- tongue accessories
- hitches
- electrical
- brake parts
- trailer hardware
- locks & pins
- towing & loading
- tie downs
- tools
- chemicals



3" X 5" TRACTOR/WORK LIGHT

• Low profile, rectangular lamp with a flood beam pattern • Black plastic housing • Adjustable stainless steel mounting hardware • Replaceable 55W H3 halogen bulb

PART #	MFG #	DESCRIPTION
PM502	35.78 V502HF	Viz Pack

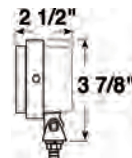
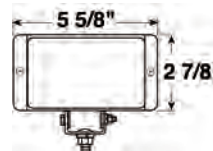

4" X 6" TRACTOR/WORK LIGHT

• 4" x 6" lens with a flood beam pattern • Black polycarbonate housing with black-plated mounting bracket for corrosion-free service • Replaceable 55W H3 halogen bulb

PART #	MFG #	DESCRIPTION
PM5040	47.95 V504HF	Viz Pack

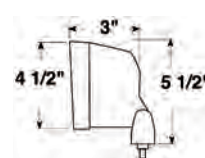
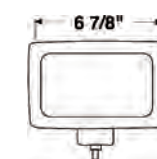

PAR 36 RUBBER TRACTOR LIGHT

• Rubber molded housing cushions lamp from shock and vibration • Features flood beam pattern • Universal 5/16" mounting stud and adjustable zinc-plated bracket allow mounting in any position • Accepts standard or halogen replacement bulb

PART #	MFG #	DESCRIPTION
PM507	30.55 V507	Viz Pack

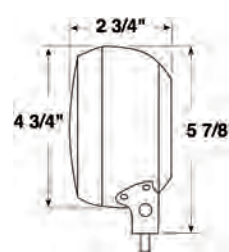

4" X 6" HALOGEN RUBBER TRACTOR LIGHT

• Heavy-duty, high-impact rubber housing is designed to survive in extreme environments such as construction and sanitation trucks • Rubber hood reduces glare and provides added protection • H9411 halogen sealed beam with trapezoidal pattern

PART #	MFG #	DESCRIPTION
PM509	48.95 V509	Viz Pack

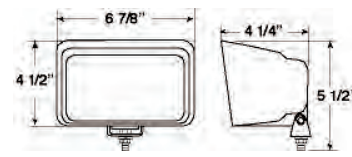

5" UTILITY/TRACTOR LIGHT

• With shock proof rubber housing and #GE4411 sealed beam bulb • Adjustable zinc plate steel bracket • Universal 5/16" mounting post

PART #	MFG #	DESCRIPTION
OP10	23.63 TL-10SS	Clamshell Pack

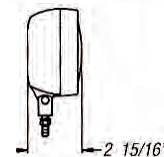
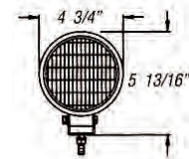

TRAILER

SPECIALTY LIGHTING



4" X 6" AUXILIARY WORK LIGHT

- Magnetic-mount auxiliary work light • Flood beam pattern • Replaceable 55W H3 halogen bulb • Black ABS housing • 15' cord with 12V lighter style plug • Self service Viz Pack packaging

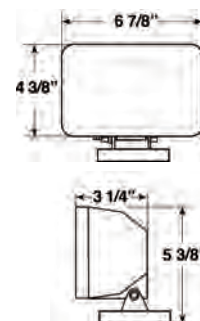

PART #	MFG #	DESCRIPTION
PM504	52.95 V504HFM	Viz Pack

UTILITY/INTERIOR LIGHTS



INTERIOR LIGHT

- Polycarbonate 12-volt interior dome light with nylon switch • For bright general illumination • Metal base surface mounts with screws on 3-1/2" centers • Separate ground and lead wires supplied for electrical connection

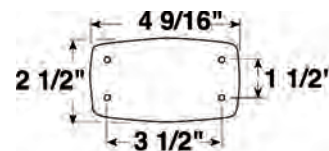

PART #	MFG #	DESCRIPTION
PM391	12.86 V391C	Viz Pack



DOME LIGHT

- Durable 12-volt interior dome light with switch • For bright general illumination • Plastic translucent lens snaps securely onto base • Plastic base for corrosion-free service • Surface mounts and grounds through base • Single lead wire supplied for electrical connection

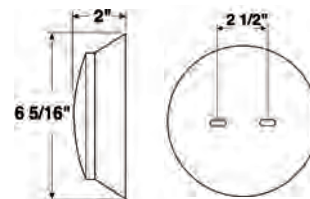

PART #	MFG #	DESCRIPTION
PM390	17.37 V390S	Viz Pack



RECTANGULAR PORCH/UTILITY LIGHTS

- Surface mount porch or utility light available with switch • Snap-in lens allows for easy bulb replacement (#93) • Contains separate ground wire • Polar white

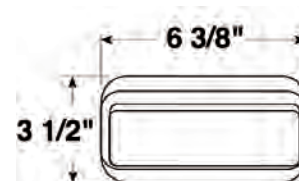

PART #	MFG #	DESCRIPTION
PM384	24.84 V384S	Viz Pack



12 VOLT UTILITY LIGHTS - TWO STYLES

- Rugged, all-purpose utility light (ideal for salt spreader applications) • 5" sealed rubber housing w/polycarbonate lens • Includes 5/16" stainless steel stud & universal adjustable mounting bracket • Shock resistant & waterproof • 4.92"W x 3.15"D x 7"H • Display packaged



PART #	MFG #	DESCRIPTION
BY2100	14.62 1492100	Incandescent Bulb
BY2110	41.50 1492110	54 Diodes, Clear

PART # BY2100
1 Incandescent Bulb
35 Watts

PART # BY2110
54 Diodes • Clear
(Very Low Amp Draw)

REPLACEMENT BULBS

PART #	DESCRIPTION	U/M	PART #	DESCRIPTION	U/M
GE168	0.60 (#168)	EA	GE97	0.50 (#67 same)	EA
GE1895	0.50 (#57 same)	EA	GE1156	0.50 Single Filament	EA
GE1034	0.50 (#1157 same)	EA	GE1034	0.50 Double Filament	EA
GE194	0.50 Push-In Type	EA			

TRAILER

UTILITY & LICENSE LIGHTS

LED LICENSE PLATE LIGHT WITH BRACKET



LED license plate light attached to corrosion proof bracket. Design includes both lead and ground wires for mounting to all surfaces. Features coated gray housing.

PART #
OP2002 20.62

LICENSE PLATE/UTILITY/DASH LIGHT



Snap-in license plate/utility/dash light, chrome plated. Mounts in 1-1/4" diameter hole. Replaceable bulb. Single wire design grounds through mounting hardware. Two units required for legal license illumination. Available in colorful retail packaging.

PART #
OP11 4.65

MINI LICENSE PLATE LIGHT



Mini license plate light features polished, chrome-plated housing. Mounting ears for surface mount. Mounts on 2" centers. Design includes both lead and ground wires for mounting to all surfaces. Gasket included for water resistance. Replaceable bulb (GE194). Available in colorful retail packaging.

PART #
OP310 5.55

LICENSE PLATE LIGHT WITH BRACKET



Unit includes a black powder-coated, steel license plate bracket riveted to light. Surface mounts on a 3-1/4" centers.

PETERSON MANUFACTURING CO.
PART #
PM4360 17.05

CHROME, STUD MOUNT LICENSE PLATE LIGHT



Features patented Vibar® socket and single lens screw for easy bulb replacement (#GE168). Ideal as replacement light for foreign car license illuminators or for customizing trucks, vans, and trailers.

PETERSON MANUFACTURING CO.
PART #
PM436X 18.00

LICENSE PLATE LIGHT



Features patented Vibar® socket and ABS hood. All internal parts are durable stainless-steel or tinned-brass. Bulb is replaceable (#GE168). Surface mounts on 3-1/4" centers.

PETERSON MANUFACTURING CO.
PART #
PM436 14.95

CHROME LICENSE PLATE LIGHT



Features patented chrome-plated steel housing and mounting bracket. Traditional style, bulb replaceable light surface mounts on 2" centers and grounds through mounting screws.

PETERSON MANUFACTURING CO.
PART #
PM435 10.05

LED LICENSE/UTILITY LIGHT

- Includes Light and mounting hardware included
- Chrome plated housing - Frosted lens
- Hooded design reduces glare
- Works with 12V systems - DOT Compliant
- Stud mount installation
- 2 LEDs - No bulb changes

PART #
989039 16.99



LICENSE PLATE BRACKETS BLACK PLASTIC OR STEEL



BLACK ANGLED

PART #
OP20 Display Pkg. 4.15
OP19 Bulk 0.85



PLASTIC STRAIGHT

PART #
OP22 Bulk 0.85



STEEL ZINC PLATED

PETERSON MANUFACTURING CO.
PART #
PM4289 Bulk 6.48

FAST SAME DAY SHIPPING

TRAILER CATALOG

tires & wheels

axles, hubs & springs

tongue accessories

hitches

electrical

brake parts

trailer hardware

locks & pins

towing & loading

tie downs

tools

chemicals

TRAILER

- tires & wheels
- axles, hubs & springs
- tongue accessories
- hitches
- electrical
- brake parts
- trailer hardware
- locks & pins
- towing & loading
- tie downs
- tools
- chemicals

TRAILER

SINGLE LIGHT WIRING HARNESS

- Quick - connecting plugs – water resistant and easy to install
- 40 amp relay and round switch
- 30 Amp fuse
- 9 Ft., 16 gauge wire
- Designed for <200W lighting systems
- IP67
- Black
- Display packaged



989044 45.49

TWO LIGHT WIRING HARNESS

- Quick - connecting plugs – water resistant and easy to install
- 40 amp relay and round, easy to install, switch
- 30 Amp fuse
- 9 Ft., 16 gauge wire
- Designed for <200W lighting systems
- IP67
- Black
- Display packaged



989045 48.19

HEAVY DUTY LIGHT WIRING HARNESS

- Quick - connecting plugs – water resistant and easy to install
- 40 amp relay and round, easy to install, switch
- 30 Amp fuse
- 9 Ft., 16 gauge wire
- Designed for 200W equal to or greater lighting systems
- IP68
- Black
- Display packaged



989046 49.79

MOUNTING BRACKETS

- Single light mounting bracket for round stock (roll-bar, push bumper, racks, etc.)
- Powder coated steel
- Easy installation
- Comes with mounting hardware and padding
- Mount can be rotated 360°
- Black
- Display packaged



2" Diameter Mounting Bracket	989052	24.29
1.75" Diameter Mounting Bracket	989053	24.29
1.50" Diameter Mounting Bracket	989054	24.29

TOGGLE - ON/OFF SWITCH

- Quick - connecting plugs – water resistant and easy to install
- 40 amp relay and round, easy to install, switch
- 30 Amp fuse
- 9 Ft., 16 gauge wire
- Designed for 200W equal to or greater lighting systems
- IP68
- Black
- Display packaged



989047 13.49

LIGHT COVERS

- Includes 6-inch and 8-inch segment
- Easy to snap on and off
- Fits most double row light bars
- Polycarbonate lens – durable and shatter proof
- Protects light bar when not in use
- Display packaged
- 2 pack



Amber lens improves visibility in fog or snow

AMBER 989050 27.29



Satisfies cover regulations in most states/providences (check local regulations)

BLACK 989051 27.29

QUICK CONNECT PLUG SET

- Male and female plugs
- 6
- Water resistant and easy to install
- Connect to light, wiring and/or harness
- Display packaged



989048 13.59

LICENSE PLATE BRACKET

- Designed to use the holes that USA and Canadian license plates fit into (license plate will attach to the bracket, as well)
- Bracket will accept stud, post and side mounting light brackets
- Powder coated steel
- Great for cameras
- Bracket can be used on bumper, racks and other locations



989055 33.49

2-WIRE PLUGS

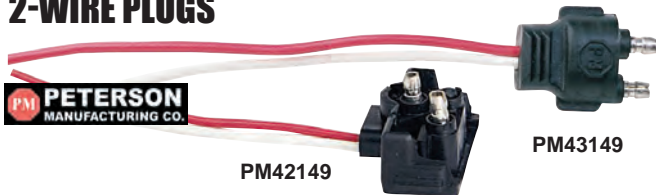

- 2-wire molded plugs for single contact sealed incandescent stop/turn or backup lamps
- Includes #10 ring terminal on ground wire; hot wire is stripped
- Available with straight or right angle plug
- Poly bagged

PART #	MFG #	DESCRIPTION
PM43149	6.12 431-49	Straight, 10-1/2"
PM42149	4.73 421-49	Right Angle, 10-1/2"

3-WIRE PLUGS

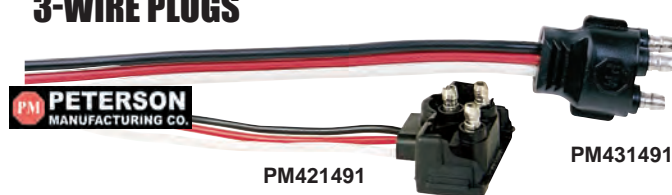

- 3-wire molded plugs for double contact sealed incandescent stop/turn or backup lamps
- Includes #10 ring terminal on ground wire; hot wire is stripped
- Available with straight or right angle plug
- Poly bagged

PART #	MFG #	DESCRIPTION
PM431491	6.26 431-491	Straight, 10-1/2"
PM421491	5.07 421-491	Right Angle, 10-1/2"

OVAL GROMMET

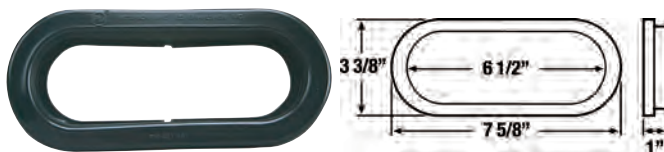

- Black PVC grommet flush mounts oval style lamps
- Provides additional shock absorption to extend lamp life

PART #	MFG #	DESCRIPTION
PM42118	5.74 421-18	Oval Grommet

2" GROMMET



- Allows 2" diameter sealed units to be flush mounted
- Fits 2-5/16" mounting hole
- Provides additional shock absorption to extend lamp life

PART #	MFG #	DESCRIPTION
PM14618	3.55 146-18	2" Grommet

4" GROMMET



- Black PVC grommet flush mounts 4" diameter round lamps in 4-1/2" hole
- Provides additional shock absorption to extend lamp life

PART #	MFG #	DESCRIPTION
PM42618	5.58 426-18	Oval Grommet

MARKER LAMP PLUG



- 2-wire molded plug for clearance and marker lights
- Includes a #10 ring terminal on ground wire; hot wire is stripped
- 6" leads

PART #	MFG #	DESCRIPTION
PM14249	5.93 142-49	Marker Lamp Plug

ELECTRO-MECHANICAL FLASHERS

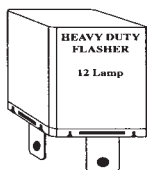

- 12-lamp, 12-volt flasher
- 70-120 flash rate
- 25.2-amp rating
- Only 1-1/2" tall, fits into small areas with limited access
- Poly bagged

PART #	MFG #	DESCRIPTION
PM570	16.95 570	2 Prong - Medium Duty
PM571	16.95 571	3 Prong - Heavy Duty

- tires & wheels
- axles, hubs & springs
- tongue accessories
- hitches
- electrical
- brake parts
- trailer hardware
- locks & pins
- towing & loading
- tie downs
- tools
- chemicals



7-WAY RV BLADE CONNECTORS - WESBARGG

METAL

- The standard of the industry
- 12 volt metal connector with plastic core
- Zinc plated to protect against corrosion
- Trigger grip for easy disconnect



PLASTIC

- 12 volt thermo-plastic connector with brass contacts to prevent corrosion
- Built-in cable clamp prevents wear on 7-way cable
- All die cast metal



BAGGED			
PART #		MFG #	DESCRIPTION
BG515705	20.51	54-57-503	Car end w/mounting bracket
BG515707	14.69	54-57-007	Trailer end

BAGGED			
PART #		MFG #	DESCRIPTION
BG517705	12.45	54-77-001	Car end w/mounting bracket
BG517703	11.21	54-77-003	Trailer end

BULK			
PART #		MFG #	DESCRIPTION
BG505705	17.62	50-57-503	Car end
BG505707	14.73	50-57-007	Trailer end

BULK			
PART #		MFG #	DESCRIPTION
BG507705	10.68	50-77-001	Car end
BG507703	10.84	50-77-003	Trailer end

WesBarg 6-WAY ZINC DIE CAST CONNECTOR

- Round brass split pins to insure a good contact
- Floating make pins promote easy connect and disconnect
- Interchangeable with all popular 6-way connectors



BAGGED			
PART #		MFG #	DESCRIPTION
BG516001	10.35	54-60-001	Car end

BULK			
PART #		MFG #	DESCRIPTION
BG506001	9.40	50-60-001	Car end

WesBarg 6-WAY AND 7-WAY PLUG HOLDER

This holder is designed to house your 6-way or 7-way trailer end connector safely out-of-the-way when disconnected from the tow car. Universal holder will accommodate either die cast, steel, plastic or molded trailer ends. Black molded plastic holder mounts on the jackpost with provided cable-ties or the attached adhesive strip and can be mounted on any flat surface with provided screws.

BAGGED			
PART #		MFG #	DESCRIPTION
444317	9.40	54-98-003	6-Way and 7-Way Plug Holder



TOW-READY 6-WAY AND 7-WAY CONNECTOR HOLDER

- Securely stores 6 and 7-Way Trailer Connectors when not in use
- Mount to tongue jack or trailer frame

BAGGED			
PART #		MFG #	DESCRIPTION
444318	11.30	118152	6-Way and 7-Way Trailer Connector Holder



PM PETERSON MANUFACTURING CO. TRAILER CONNECTOR HOLDER

- Universal holder stores trailer end connector safely when disconnected from tow vehicle
- Holds both 1" and 1-1/2" diameter connector ends
- Mounts on trailer jack post with included cable ties, or any flat surface with included screws



PART #		MFG #	DESCRIPTION
PM5419	7.95	50-77-070	Viz Pack

TRAILER

WesBarg CAR END MOUNTING BRACKETS

Heavy duty plated steel brackets. Features reinforcing beads or flanges for strength. The Black plated model can blend in with the black connector and black hitch for clean consistent finish. Combination brackets have a black, powder coat finish and are formed from 16 gauge steel for strength and durability. Combination brackets are for use with Wesbarg and Wesbarg branded 4-Way and 5-Way Flat connectors.

4-WAY FLAT CAR END CONNECTOR MOUNTING BRACKETS

PART #	MFG #	DESCRIPTION
444319	10.18	54-18137 4, 5 and 6-Way Round Black Mounting Bracket w/Screws and Nuts (A)

5-WAY FLAT CAR END CONNECTOR MOUNTING BRACKETS

PART #	MFG #	DESCRIPTION
444320	4.23	54-20045 5-Way Flat Black Mounting Bracket (B)
444319	10.18	54-18137 4, 5 and 6-Way Round Black Mounting Bracket w/Screws and Nuts (A)

6-WAY FLAT CAR END CONNECTOR MOUNTING BRACKETS

PART #	MFG #	DESCRIPTION
444319	10.18	54-18137 4, 5 and 6-Way Round Black Mounting Bracket w/Screws and Nuts (A)

COMBINATION CONNECTOR MOUNTING BRACKETS

PART #	MFG #	DESCRIPTION
444323	10.35	54-77-075 7_Way and 5-Way Flat Mounting Bracket (C)

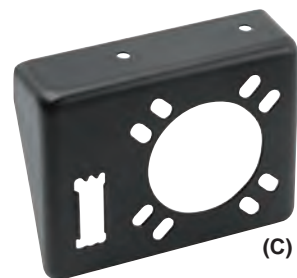
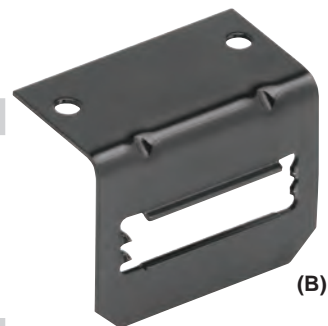
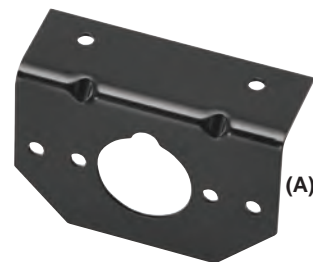

- tires & wheels
- axles, hubs & springs
- tongue accessories
- hitches
- electrical
- brake parts
- trailer hardware
- locks & pins
- towing & loading
- tie downs
- tools
- chemicals

WesBarg 7-WAY CAR END CONNECTOR MOUNTING BRACKET

- Zinc plated heavy-duty 16 gauge steel with reinforced beads and flanges for strength
- Sold each (bulk)
- To be used with either 7 way connector sold on previous page

PART #	MFG #	COLOR
BG507770	2.48	50-77-070 Zinc
BG507771	2.52	50-77-071 Black

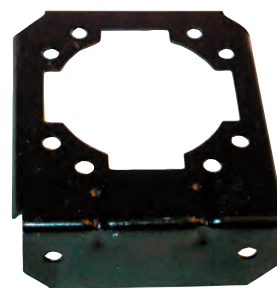

4-WAY AND 6-WAY MOUNTING BRACKET

PART #	MFG #	DESCRIPTION
444324	10.33	118132 Mounting Bracket for 4 & 6-Way Round Connectors (Does not include Fasteners)



TRAILER

FAST SAME DAY SHIPPING

- tires & wheels
- axles, hubs & springs
- tongue accessories
- hitches
- electrical
- brake parts
- trailer hardware
- locks & pins
- towing & loading
- tie downs
- tools
- chemicals

ELECTRICAL MOUNTING BRACKET 4 • 5 • 6 • 7 WAY CONNECTORS



- These mounting brackets allow for installation of electrical wiring plugs on vehicles without damage to bumpers or trim
- Attachment brackets are designed to attach above or below receiver cross tube with hose clamp



444325

ATTACHMENT BRACKET (PIECE 1 OF 2)

- Attaches to cross tube of hitch

PART #	MFG #	DESCRIPTION
444325	20.06	118136 Attachment Bracket For 6 & 7-Way Round Connectors, Includes Clamp (Piece 1 of 2, Long Bracket)
444326	21.21	118140 Attachment Bracket For 4-Flat, 5-Flat, 4-Way & 5-Way Round Connectors, Includes Clamp (Piece 1 of 2, Short Bracket)



444326

MOUNTING BRACKETS (PIECE 2 OF 2)

- Mounts electrical connector to attachment bracket
- Includes screws and nuts
- Attractive point-of-purchase packaging

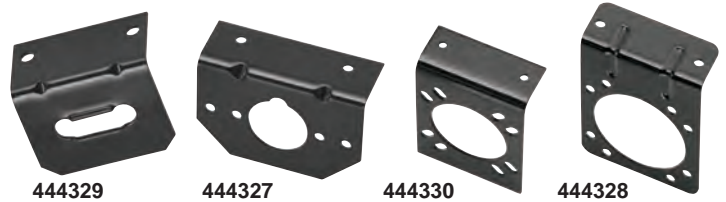

PART #	MFG #	DESCRIPTION
444327	9.37	118137 Mounting Bracket For 4, 5 & 6-Way Round Connectors, (Piece 2 Of 2)
444328	7.37	118138 Mounting Bracket, (Piece 2 Of 2)
444329	6.37	118144 Mounting Bracket For 4-Flat Connectors, (Piece 2 Of 2)
444330	9.07	20212 Mounting Bracket For 7-Way Us Car Connectors, (Piece 2 Of 2)
444331	10.26	20046 Mounting Bracket For 5-Flat Connectors, (Piece 2 Of 2)



444331

4-WAY FLAT CAR END CONNECTOR MOUNTING BRACKETS

PART #	MFG #	DESCRIPTION
444332	9.91	118149 4-Way Flat Universal Mounting Bracket



6-WAY AND 7-WAY CONNECTOR MOUNTING BOXES

- No need to disconnect existing wiring
- No drilling
- Mounts with hose clamp included
- Corrosion free
- High impact plastic
- Fits all standard & U.S. car 7-way connectors



PART #	MFG #	DESCRIPTION
444314	16.21	118156 6-Way and 7-Way Connector Mounting Box For Hitches w/2-1/2" Sq. Cross Tubes
444315	16.21	118157 6-Way and 7-Way Connector Mounting Box For Hitches w/3" Sq. Cross Tubes
444316	19.14	118159 6-Way and 7-Way Connector Mounting Box With Universal Fit For Both Square And Round Tube Hitches

TRAILER

VEHICLE / TRAILER ADAPTERS



7-WAY TO 4-WAY RETRACTABLE WIRING ADAPTER

- Converts 7-way round blade connector to standard 4-way flat connector
- Adjust length up to 42", no wires dragging on the ground
- Retractable 4-way flat car end plug connects with standard 4-way flat trailer end plug
- Adapts to factory 7-way blade receptacle
- Protects & stores when not in use

PART #	MFG #	DESCRIPTION
444333	103.71 78007	7-way Round Blade to 4-way Flat



7-WAY BLADE TO 4-FLAT W/LED CIRCUIT TESTER

- Easily adapt OEM 7-way blade connector to either 5-flat or a 4-flat connector, Patent pending
- Instantly checks electrical circuit for connectivity
- Displays connectivity using high visibility Blue LEDs
- Attached dust cover included to keep terminals clean when not towing a trailer

PART #	MFG #	DESCRIPTION
444334	34.72 78118	7-Way Blade to 4 or 5-Flat w/LED Circuit Tester



7-WAY TO 4-WAY WITH TOW-GLO

- Easily adapt OEM 7-way blade connector to basic 4-flat connector
- Glows BLUE when tail light circuit is activated assisting on seeing connection at night-time
- Attached dust cover included to keep terminals clean when not towing a trailer

PART #	MFG #	DESCRIPTION
444335	31.37 78117	7-Way Blade to 4-Flat w/Tow-Glo



7-WAY TRAILER EXTENSION

- Durable connectors
- 7 ft. lead reaches almost anywhere



PART #	MFG #	DESCRIPTION
444337	76.56 118664	7-Way Connector - extension cable 7'

- tires & wheels
- axles, hubs & springs
- tongue accessories
- hitches
- electrical
- brake parts
- trailer hardware
- locks & pins
- towing & loading
- tie downs
- tools
- chemicals

TRAILER



- tires & wheels
- axles, hubs & springs
- tongue accessories
- hitches
- electrical
- brake parts
- trailer hardware
- locks & pins
- towing & loading
- tie downs
- tools
- chemicals

444338

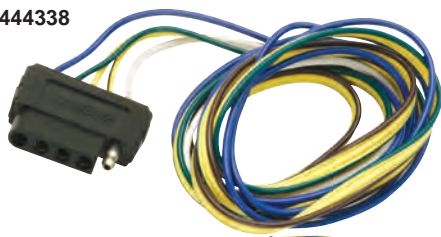

444339



444340



444341



5-WAY FLAT WIRE HARNESSSES

Color coded harnesses in various lengths available with car and trailer end connectors. Trailer ends can be purchased in wunside or wishbone harness styles. Various length and combinations are available.

5-WAY FLAT CAR END WIRE HARNESS

PART #		MFG #	DESCRIPTION
444338	12.45	702305	5-Way Flat 4 Ft. Car End , 18" Ground, 4 Ft. Auxiliary

5-WAY FLAT TRAILER END WIRE HARNESS - WISHBONE STYLE

PART #		MFG #	DESCRIPTION
444339	28.53	702275	5-Way Flat 25 Ft. Trailer End, Wishbone Harness, 4 Ft. Ground, 5 Ft. Auxiliary

5-WAY FLAT TRAILER END WIRE HARNESS WITH CAR END - WISHBONE STYLE

PART #		MFG #	DESCRIPTION
444340	48.10	707105	5-Way Flat 25 Ft. Trailer End, Wishbone Harness Kit w/Hardware, 4 Ft. Ground, 5 Ft. Auxiliary w/6 Ft. Car End, 6 Ft. Ground, 6 Ft. Auxiliary

DOUBLE ENDED 5-WAY FLAT WIRE HARNESS - EXTENSION STYLE

PART #		MFG #	DESCRIPTION
444341	13.04	707255	Double Ended 5-Way 2 Ft. Cord (5-Way Flat Car and Trailers Ends

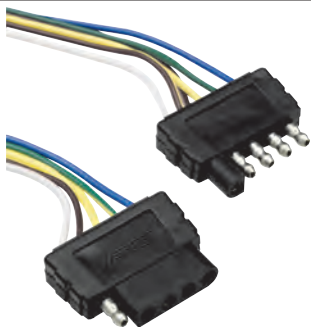

5-WAY FLAT ELECTRICAL WIRE HARNESSSES



- Fifth wire added for surge brake lockout or backup light circuit on today's newer trailers
- 7.5 amps maximum per circuit

PART #		MFG #	DESCRIPTION
444342	13.34	118016	5-Flat 72" Car End Wiring Harness
444343	13.14	118017	5-Flat 48" Trailer End Wiring Harness
444344	16.69	118215	5-Flat 72" Car & Trailer End Loop

TRAILER

444345



4-WAY FLAT DUST COVER



PART #		MFG #	DESCRIPTION
444345	6.43	787301	4-Way Flat Dust Cover

444346



4-WAY FLAT DUST COVER W/LED TESTER



PART #		MFG #	DESCRIPTION
444346	67.53	118147-025	4-Way Flat Dust Cover w/LED Tester

444347



5-WAY FLAT DUST COVER



PART #		MFG #	DESCRIPTION
444347	11.41	20118	Dust Cover, 5-Flat Connector

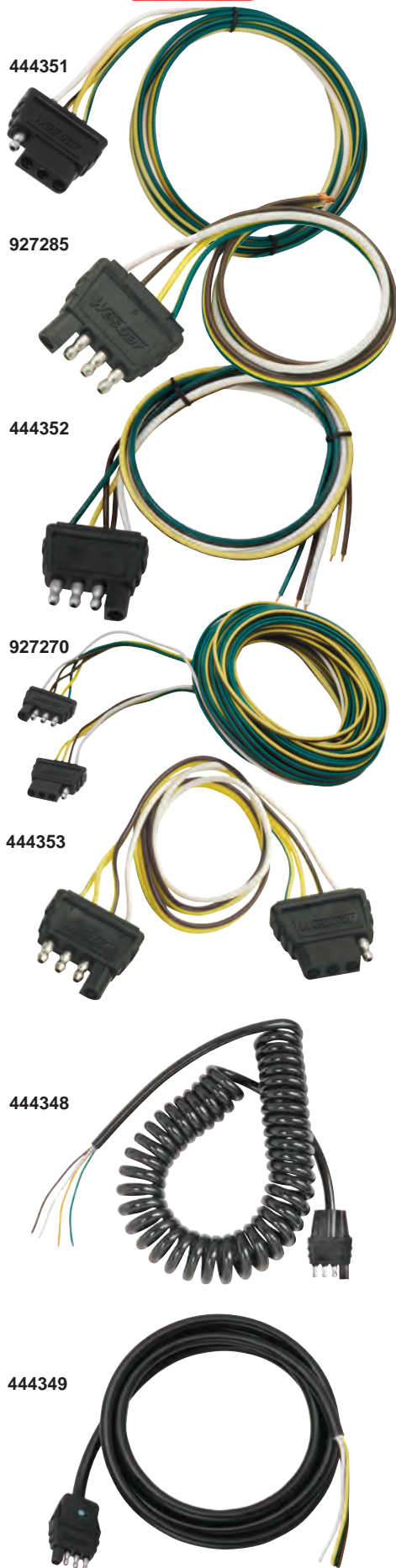

444351

927285

444352

927270

444353

444348

444349

4-WAY FLAT WIRE HARNESSSES

Color coded harnesses in various lengths available with car and trailer end connectors. Trailer ends can be purchased in straight lengths, loops, wunside or wishbone harness styles. Various length and combinations are available.

4-WAY FLAT CAR END WIRE HARNESS

PART #	MFG #	DESCRIPTION
444351	11.91 707272	4-Way Flat 6 Ft. Car End, 6 Ft. Ground

4-WAY FLAT TRAILER END WIRE HARNESS - WUNSIDE STYLE

PART #	MFG #	DESCRIPTION
927285	7.13 707285	4-Way Flat 18" Trailer End, Wunside Harness, 18" Ground

4-WAY FLAT TRAILER END WIRE HARNESS - WISHBONE STYLE

PART #	MFG #	DESCRIPTION
444352	8.17 707286	4-Way Flat 18" Trailer End, Wishbone Harness, 18" Ground

4-WAY FLAT TRAILER END WIRE HARNESSSES WITH CAR ENDS - WISHBONE STYLE

PART #	MFG #	DESCRIPTION
927270	12.31 707270	4-Way Flat 18" Trailer End, Wishbone Harness, 18" Ground w/4 Ft. Car End, 18" Ground

DOUBLE ENDED 4-WAY FLAT WIRE HARNESS - EXTENSION STYLE

PART #	MFG #	DESCRIPTION
444353	10.73 707254	Double Ended 4-Way 2 Ft. Cord (4-Way Flat Car & Trailer Ends)

4-WAY FLAT WIRE HARNESSSES WITH COILED CABLE

Coiled 14 gauge cable available with 4-way flat trailer end connectors. Cable extended length to 11 feet.

PART #	MFG #	DESCRIPTION
444348	45.58 54000-026	7-Way Connector - extension cable 7'

4-WAY FLAT CONNECTORS WITH JACKETED CABLE

Color coded sealed cable available with trailer end connector, jacketed cable and 4' stripped wire leads. No exposed wires and sealed for environmental protection.

PART #	MFG #	DESCRIPTION
444349	16.01 787264	4-Way Flat 4' Trailer End w/Jacketed Cable
444350	24.06 787268	4-Way Flat 8' Trailer End w/Jacketed Cable

- tires & wheels
- axles, hubs & springs
- tongue accessories
- hitches
- electrical
- brake parts
- trailer hardware
- locks & pins
- towing & loading
- tie downs
- tools
- chemicals

TRAILER

MULTI-TOW® ADAPTERS



Hopkins® Multi-Tow® adapters provide multiple towing options from one vehicle-end connector creating a true customized Plug-In Simple® wiring system.

ENDURANCE™ MULTI-TOW® 7 TO 6, 5 AND 4

- Patented Quick-Change™ plug quickly accommodates both 6 pole wiring codes
- Provides four towing options from a single device
- Overbuilt hinge, lid and connector housings provide maximum durability



PART #
647570 32.89

MULTI-TOW® 6 : 4

- 4-wire flat to both 4-wire flat and 6 pole round adapter



PART #
647175 44.95

MULTI-TOW® 7 TO 6 AND 4

- 7 RV blade to both 6 pole round and 4-wire flat
- Center pin auxiliary
- Center pin can be switched to auxiliary or electric brake



PART #
647565 26.39

MULTI-TOW® 7 TO 6 AND 4 WITH NITE-GLOW™

- 7 RV blade to both 6 pole round and 4-wire flat
- Lights-up on taillight function



PART #
647585 30.49

MULTI-TOW® 7 : 4

- 4-wire flat to both 4-wire flat and 7 RV blade adapter



PART #
647185 45.95

MULTI-TOW® 7 TO 6 AND 4

- 7 RV blade to both 6 pole round and 4-wire flat
- Center pin electric brake
- Center pin can be switched to auxiliary or electric brake



PART #
647575 26.39

MULTI-TOW® 7 TO 5 AND 4 WITH 12-VOLT

- 7 RV blade to 5-wire flat and 4-wire flat with 12-volt power socket



PART #
647675 26.09

MULTI-TOW® 7 TO 5 AND 4

- 7 RV blade to both 5-wire flat and 4-wire flat
- Includes dust covers



PART #
647385 23.95

L.E.D. ADAPTERS

FUNCTIONS TESTED	647325 6 TO 4	647345 7 TO 4	647525 7 TO 6	647535 7 TO 6
Right turn & brake	•	•	•	•
Left turn & brake	•	•	•	•
Taillights	•	•	•	•
Electric brake			▲	•
Auxiliary				▲

▲ Can be rewired to test this function

7 RV BLADE TO 6 POLE ROUND

- Center pin auxiliary
- Built-in trouble-shooting
- Function testing L.E.D.s
- Universal - center pin can be switched to auxiliary or electric brake



PART #
647525 26.29

6 POLE ROUND TO 4-WIRE FLAT

- Includes function testing L.E.D.s
- Includes dust cover



PART #
647325 15.79

7 RV BLADE TO 6 POLE ROUND

- Center pin electric brake
- Built-in trouble-shooting
- Function testing L.E.D.s
- Universal - center pin can be switched to auxiliary or electric brake



PART #
647535 26.29

7 RV BLADE TO 4-WIRE FLAT

- Includes function testing L.E.D.s
- Includes dust cover



PART #
647345 15.79

7 RV BLADE TO 4-WIRE FLAT NITE-GLOW™

- Lights-up on taillight function
- Find your connection in the dark
- Includes dust cover



PART #
647335 16.19

ENDURANCE™ QUICK-FIX™ 4-WIRE FLAT

- Replaces damaged 4-Wire Flat
- No external splices for enhanced weatherproofing
- Includes vehicle and trailer sides
- Corrosion resistant terminals

PART #
648195 9.79



TRAILER



POWER MANAGEMENT

Our power management products help you get 12-volt power wherever you may need it in your vehicle. Great for tailgating, camping, hunting, boating, emergency use...and countless other applications.

Products that plug into a 12-volt socket include blenders, coolers, air compressors, spot lights, radios, TVs...imagine the possibilities!



12-VOLT POWER SOCKET

- Flush-mount design means no drilling required
- Mounts anywhere 12-volt power is needed
- Weatherproof dust cover

PART #

655110 15.19

12-VOLT POWER SOCKET

- Includes 17 ft. power wire and fuse assembly

PART #

655115 24.19

7 RV BLADE TO 5-WIRE FLAT AND 4-WIRE FLAT WITH 12-VOLT

- Turn your 7 RV blade into a 12-volt power socket
- Weatherproof dust covers

PART #

647675 26.09

12-VOLT POWER SOCKET WITH UTILITY LIGHT

- Provides L.E.D. utility light for multipurpose use
- Flush mount design
- Mounts anywhere 12-volt power is needed
- Weatherproof dust cover

BUILT-IN L.E.D. UTILITY LIGHT

PART #

655120 19.59

12-VOLT POWER SOCKET WITH UTILITY LIGHT

- Includes 17 ft. power wire and fuse assembly

PART #

655125 27.79



7 RV BLADES

Seven-pole connectors are typically used with large trailers (RV and industrial). These connectors provide all the functions of the 6 pole with the addition of the backup/reverse function.

7 RV BLADE CONNECTOR KIT

Contains matched set plastic plug and socket, mounting bracket and mounting hardware.



MOUNTING BRACKET ONLY

PART # 648615

Works with various 7-way RV and 7-way pole style vehicle end sockets

PART #

648465 22.49

TRAILER END PLUG

(Plastic)



PART #

648505 12.29

TOW VEHICLE END SOCKET

(Plastic)

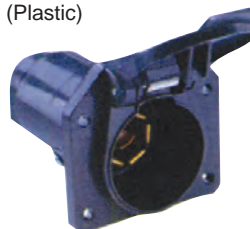

PART #

648485 14.99

TRAILER END PLUG

(Metal)



PART #

648515 14.09

ENDURANCE™ TRAILER END PLUG



PART #

648500 18.59

ENDURANCE™ TOW VEHICLE END SOCKET



PART #

648480 23.19

ENDURANCE™ MULTI-TOW® 3-IN-1 CONNECTOR

7-5-4 vehicle end socket



PART #

648470 39.69

TOW VEHICLE END SOCKET

(Metal)



PART #

648495 15.49

FAST SAME DAY SHIPPING

- tires & wheels
- axles, hubs & springs
- tongue accessories
- hitches
- electrical
- brake parts
- trailer hardware
- locks & pins
- towing & loading
- tie downs
- tools
- chemicals

TRAILER

7 RV BLADES

ENDURANCE™ FORD/CHEVY/GMC OEM REPLACEMENT

- Compatible with Ford, GM and other popular tow vehicles
- Plug-In Simple!® for quick and easy installation or replacement
- Durable lid opens 180 degrees
- Ultimate weatherproofing



PART #
620415 19.69

MAKE/MODEL	YEAR
AUDI	
Q3	09-15
Q5	09-14
Q7	07-15
BUICK	
Enclave	08-15
Rainier	02-15
CADILLAC	
Escalade / EXT / ESV	02-13
SRX	10-14

MAKE/MODEL	YEAR
CHEVY	
1500 Pickups	03-13
2500/2500 Pickups	99-13
1500/2500/3500	14-15
Avalanche	08-12
Tahoe	00-15
Trailblazer	02-09
Suburban	00-15
Colorado	03-15
Express Van	03-15
Traverse	10-15
CHRYSLER	
Aspen	07-09

MAKE/MODEL	YEAR
DODGE	
Durango	07-15
Nitro	07-09
Journey	09-10
Ram 1500 Pickups	10-15
Ram 2500/3500	10-15
FORD	
F-Series	08-15
Escape	13-15
Expedition	99-14
Excursion	00-05
Explorer	02-15
Explorer Sport	07-10
Trac	
Flex	09-15
E-Vans	04-14
GMC	
1500 Pickups	03-13
2500/3500 Pickups	99-13
1500/2500/3500	14-15
Envoy	02-09
Yukon/XL	00-15
Denali	00-15
Acadia	07-15
Canyon	08-12
Savanna Van	09-15

MAKE/MODEL	YEAR
HUMMER	
H2/H2 SUT	03-09
H3	06-09
H3 SUT	2009
INFINITY	
QX-56	04-15
ISUZU	
Ascender	04-08
JEEP	
Cherokee	14-15
Liberty	08-10
Gd. Cherokee	11-15
KIA	
Borrego	2009
LINCOLN	
Aviator	03-06
Navigator	99-15
Mark LT	06-08
MKT	09-14
MERCURY	
Mountaineer	02-10



MAKE/MODEL	YEAR
NISSAN	
Armada	04-13
Pathfinder	13-15
Titan	04-15
OLDSMOBILE	
Bravada	02-04
SAAB	
9-7X	05-10
SATURN	
Outlook	07-09
Transit	15
TOYOTA	
4-Runner	10-13
Sequoia	10-14
Tundra	14-15
VOLKSWAGON	
Toureg	12-15

ENDURANCE™ DODGE/CHRYSLER/JEEP OEM QUICK-INSTALL™ WIRING KIT

- Allows for Dodge trucks to adapt to the Quick-Install™ 7 RV Blade
- Reinforced lid opens 180 degrees to prevent breaking
- Ultimate weatherproofing



PART #
620416 40.95

MAKE/MODEL	YEAR
CHRYSLER	
Aspen	Early 07
Pacifica	03-08
DODGE	
Ram 1500	00-09
Ram 2500/3500	00-09
Dakota	00-10
Durango	00-07
Sprinter	04-09
Ram Van	01-03

MAKE/MODEL	YEAR
JEEP	
Commander	06-10
Grand Cherokee	00-10
Liberty	05-07
Wrangler	04-15
MITSUBISHI	
GL-Class	07-10

ENDURANCE™ 4 FLAT TO 7 RV BLADE QUICK-INSTALL™ WIRING KIT

- Allows existing 4 flat to adapt to the Quick-Install™ 7 RV Blade
- Quick and easy installation or replacement
- Reinforced lid opens 180 degrees to prevent breaking
- Ultimate weatherproofing



PART #
620417 39.79

ENDURANCE™ CHEVY/GM TWIST MOUNT BLADE

OEM Replacement



PART #
620412 19.69

MODEL	YEAR
BUICK	
ENCLAVE	08-12
ASCENDER	04-08
CADILLAC	
ESCALADE/ EXT	02-13

MODEL	YEAR
CHEVY	
1500 PICKUPS	03-13
2500/3500 PICKUPS	99-13
AVALANCHE	02-13
TAHOE	00-13
TRAILBLAZER	02-09
SUBURBAN	00-15
COLORADO	08-11
EXPRESS VAN	03-13
SAVANA VAN	09-13
GMC	
ENVOY	02-09
YUKON/XL/ DENALI	01-14
ACADIA	07-12
CANYON	08-13
HUMMER	
H2/ H2 SUT	03-09
H3	06-09
H3T	2009
RAINIER	04-07
OLDSMOBILE	
BRAVADA	02-04
SAAB	
9-7X	05-10
SATURN	
OUTLOOK	07-09
TRAVERSE	10-13

ENDURANCE™ 7 BLADE MOLDED CABLE

- 3 foot cable
- Mounts to vehicle bumper



PART #
620419 56.09

ENDURANCE™ UNIVERSAL QUICK-INSTALL™ WIRING KIT

- Pre-wired universal connection allows for flexibility in installation
- Plug-In Simple!® for quick and easy installation
- Reinforced lid opens 180 degrees to prevent breaking
- Ultimate weatherproofing



PART #
620418 36.99

TRAILER

PLUG-IN SIMPLE!® ADAPTERS



tires & wheels

axles, hubs & springs

tongue accessories

hitches

electrical

brake parts

trailer hardware

locks & pins

towing & loading

tie downs

tools

chemicals

TRAILER

4-WIRE FLAT TO 6 POLE ROUND

(Plastic)



PART # 647155 34.29

4-WIRE FLAT TO 6 POLE ROUND

(Metal)



PART # 647165 33.99

7 RV BLADE TO 7-WAY PIN TYPE

(Flexible)



PART # 647595 41.29

6 POLE ROUND TO 4-WIRE FLAT

(With dust cover)



PART # 647305 13.29

6 POLE ROUND TO 4-WIRE FLAT

(Flexible, with dust cover)



PART # 647315 19.89

7 RV BLADE TO 4-WIRE FLAT

(With dust cover)



PART # 647355 13.39

7 RV BLADE TO 4-WIRE FLAT

(Flexible, with dust cover)



PART # 647365 21.39

7 RV BLADE TO 5-WIRE FLAT



PART # 647375 17.09

7-WAY PIN TYPE TO 4-WIRE FLAT



PART # 13 13.29

6 POLE ROUND TO 6 POLE SQUARE

(Flexible)



PART # 647415 19.59

6 POLE ROUND TO 7 RV BLADE

(Flexible)



PART # 647435 32.79

4-WAY ROUND TO 4-WIRE FLAT

(Flexible, with dust cover)



PART # 647465 14.69

7 RV BLADE TO 6 POLE ROUND

Center pin auxiliary (With dust cover)

PART # 647545 21.59



7 RV BLADE TO 6 POLE ROUND

PART # 647555 20.99

Center pin electric brake (With dust cover)
UNIVERSAL - Center pin can be switched to auxiliary or electric brake

4-WIRE FLAT KNOCKOUT

(For use with 1.25" hole diameter or #648605 bracket, with dust cover)

PART # 647605 7.99



FAST SAME DAY SHIPPING

FLEX-COIL HEAVY DUTY ADAPTERS



Flex-Coil™ adapters provide the user with increased durability and additional length that may be necessary to reach between the tow vehicle's socket and the trailer/towed vehicle's plug.

In addition, Flex-Coil™ adapters with Nite-Glow™ illuminate upon activation of the taillight function.

This enables the user to find the electrical connection in the dark and show that the vehicle's trailer wiring system is working properly.

7 RV BLADE TO 4-WIRE FLAT NITE-GLOW™



- 3 ft. stretch
- Increased weatherproofing
- Tin-plated terminals
- Easy-grip connectors
- Heavy-duty cable

PART #	MFG #	
647015	47015	49.95

7 RV BLADE TO 5-WIRE FLAT NITE-GLOW™



- 3 ft. stretch
- Increased weatherproofing
- Tin-plated terminals
- Easy-grip connectors
- Heavy-duty cable

PART #	MFG #	
647025	47025	52.29

4 POLE ROUND TO 4 POLE ROUND NITE-GLOW™

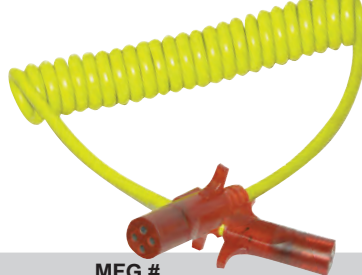

- Great for RVing
- 8 ft. stretch
- Increased weatherproofing
- Tin-plated terminals
- Easy-grip connectors
- Heavy-duty cable

PART #	MFG #	
647045	47045	59.95

6 POLE ROUND TO 6 POLE ROUND NITE-GLOW™



- Great for RVing
- 8 ft. stretch
- Increased weatherproofing
- Tin-plated terminals
- Easy-grip connectors
- Heavy-duty cable

PART #	MFG #	
647055	47055	74.95

7 RV BLADE TO 4-WIRE FLAT NITE-GLOW™

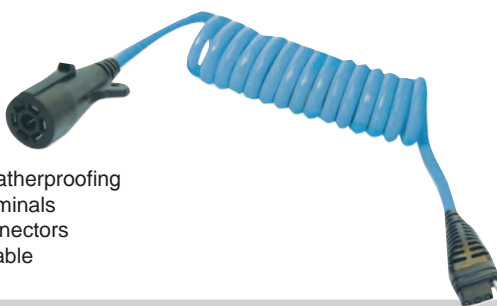

- 3 ft. stretch
- Increased weatherproofing
- Tin-plated terminals
- Easy-grip connectors
- Heavy-duty cable

PART #	MFG #	
647065	47065	45.95

7 RV BLADE TO 5-WIRE FLAT NITE-GLOW™

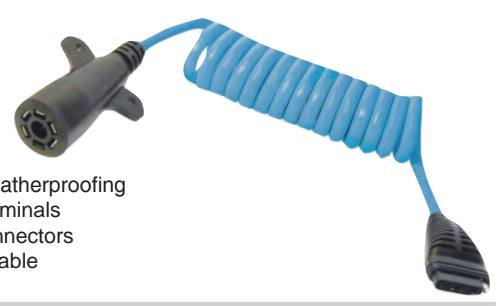

- 3 ft. stretch
- Increased weatherproofing
- Tin-plated terminals
- Easy-grip connectors
- Heavy-duty cable

PART #	MFG #	
647075	47075	54.69

7 RV BLADE TO 6 POLE ROUND

CENTER PIN AUXILIARY

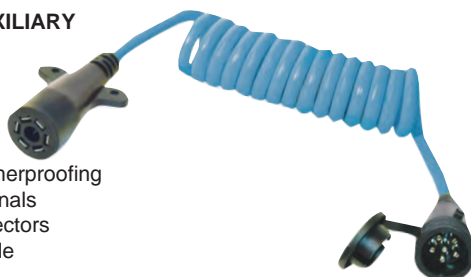

- 3 ft. stretch
- Increased weatherproofing
- Tin-plated terminals
- Easy-grip connectors
- Heavy-duty cable

PART #	MFG #	
647083	47083	73.95

7 RV BLADE TO 6 POLE ROUND

CENTER PIN ELECTRIC BRAKE



- 3 ft. stretch
- Increased weatherproofing
- Tin-plated terminals
- Easy-grip connectors
- Heavy-duty cable

PART #	MFG #	
647085	47085	73.95

TRAILER

PLUG-IN SIMPLE!® VEHICLE SPECIFIC WIRING KIT 4 WIRE FLAT



MODEL	YEAR	KIT PART #	
AUDI			
Q5 (with tow package)	09-14	641155	26.09
Q7 (with tow package)	07-15	641155	26.09
BUICK			
Enclave (with tow package)	08-12	641155	26.09
Enclave (with tow package)	13-16	641155	26.09
Rainier	04-07	641155	26.09
Rendezvous	02-07	641405	25.95
CADILLAC			
Escalade	99-00	641125	26.99
Escalade	02-06	641155	26.09
Escalade / EXT / ESV	07-13	641155	26.09
Escalade / EXT / ESV	14-15	641155	26.09
CHEVROLET			
Avalanche	02-06	641155	26.09
Avalanche (4 pin taillight plug)	07-13	641155	26.09
Avalanche (5 pin taillight plug)	07-13	641155	26.09
Avalanche (6 pin taillight plug)	07-13	641155	26.09
Blazer (full size)	92-94	641125	26.99
S-10 Blazer (2 door)	84-91	641205	33.29
Colorado	04-07	641165	50.39
Colorado (without tow package)	08-12	641165	50.39
Colorado (with tow package)	08-12	641155	26.09
Colorado (with tow package)	15-16	641155	26.09
Express Van (with tow package)	08-16	641155	26.09
Pickup (full size)	88-98	641125	26.99
Pickup C/K (old body style)	99-00	641125	26.99
Silverado 1500 (new body style)	99-02	641145	42.99
Silverado 1500	03-07	641155	26.09
Silverado 1500 (new body style)	07-13	641155	26.09
Silverado 2500/3500 (new body style)	99-02	641155	26.09
Silverado 2500/3500	03-07	641155	26.09
Silverado 2500/3500 (new body style)	07-13	641155	26.09
Silverado 1500, 2500, 3500	14-16	641155	26.09
Suburban	92-99	641125	26.99
Suburban	00-06	641155	26.09
Suburban (4 pin taillight plug)	07-13	641155	26.09
Suburban (5 pin taillight plug)	07-13	641155	26.09
Suburban (6 pin taillight plug)	07-13	641155	26.09
Suburban (4 pin taillight plug)	14	641155	26.09
Suburban (5 pin taillight plug)	14	641155	26.09
Suburban (6 pin taillight plug)	14	641155	26.09
Suburban (4 pin taillight plug)	15	641155	26.09
Suburban (5 pin taillight plug)	15	641155	26.09
Suburban (6 pin taillight plug)	15	641155	26.09
Tahoe	95-99	641125	26.99
Tahoe	00-06	641155	26.09
Tahoe (4 pin taillight plug)	07-13	641155	26.09
Tahoe (5 pin taillight plug)	07-13	641155	26.09
Tahoe (6 pin taillight plug)	07-13	641155	26.09
Tahoe (4 pin taillight plug)	14	641155	26.09
Tahoe (5 pin taillight plug)	14	641155	26.09
Tahoe (6 pin taillight plug)	14	641155	26.09
Tahoe (4 pin taillight plug)	15	641155	26.09
Tahoe (5 pin taillight plug)	15	641155	26.09
Tahoe (6 pin taillight plug)	15	641155	26.09
Trailblazer	02-09	641155	26.09
Traverse (with tow package)	10-16	641155	26.09
CHRYSLER			
Aspen	07-09	642245	73.59
Aspen (with tow package)	07-09	641155	26.09
Town & Country	91-95	642205	46.99
Town & Country	04-07	642235	47.09

MODEL	YEAR	KIT PART #	
DODGE			
Caravan / Grand Caravan	91-95	642205	46.99
Caravan / Grand Caravan	04-07	642235	47.09
Dakota	87-94	642105	41.19
Dakota	04-11	642205	46.99
Durango	04-09	642245	73.59
Durango (with tow package)	07-15	641155	26.09
Journey (with tow package)	09-10	641155	26.09
Nitro (with tow package)	07-09	641155	26.09
Ram Pickup (all sizes)	87-94	642105	41.19
Ram Pickup (cab & chassis only)	95-02	642105	41.19
Ram Pickup 1500	02-06	642135	71.49
Ram Pickup 1500	07-09	642205	46.99
Ram 1500 (with tow package)	10-16	641155	26.09
Ram Pickup 2500/3500	03-06	642135	71.49
Ram Pickup 2500/3500	07-09	642205	46.99
Ram Pickup 2500/3500 (with tow package)	10-16	641155	26.09
Ram Promaster (with tow package)	14-16	641155	26.09
Ramcharger / Trailduster	88-93	642105	41.19
FORD			
Econoline Van (with factory 7 blade)	04-15	641155	26.09
Escape (with tow package)	01-04	640445	20.49
Escape (with tow package)	05-07	640455	20.49
Escape (with tow package)	13-16	641155	26.09
Excursion	00-05	641155	26.09
Expedition (with factory 7 blade)	99-15	641155	26.09
Explorer (with factory 7 blade)	02-16	641155	26.09
Explorer Sport Trac (with tow package)	07-10	641155	26.09
F-150 (with tow package)	08-15	641155	26.09
F-250 Heavy Duty, F-350 (without tow package)	02-04	640165	23.49
F-250, 350 (with tow package)	05-16	641155	26.09
Flex (with tow package)	09-15	641155	26.09
Transit T-150 Van (with tow package)	15-16	641155	26.09
Transit T-250 Wagon (with tow package)	15-16	641155	26.09
Transit T-350 Wagon XLT (with tow package)	15-16	641155	26.09
GMC			
Acadia (with tow package)	07-16	641155	26.09
Canyon	04-07	641165	50.39
Canyon (without tow package)	08-12	641165	50.39
Canyon (with tow package)	08-12	641155	26.09
Canyon (with tow package)	15-16	641155	26.09
Denali	99-00	641125	26.99
Denali	01-14	641155	26.09
Envoy (with tow package)	02-09	641155	26.09
Jimmy (full size)	92-94	641125	26.99
S-15 Jimmy (2 door)	84-91	641205	33.29
Pickup (full size)	88-98	641125	26.99
Pickup (Classic) (old body style)	99-00	641125	26.99
Sierra 1500 (new body style)	99-02	641145	42.99
Sierra 1500	03-07	641155	26.09
Sierra 1500 (new body style)	07-13	641155	26.09
Sierra 2500/3500 (new body style)	99-02	641155	26.09
Sierra 2500/3500	03-07	641155	26.09
Sierra 2500/3500 (new body style)	07-13	641155	26.09
Sierra 1500, 2500, 3500	14-16	641155	26.09
Suburban	92-99	641125	26.99
Savana Van (full size) (with tow package)	08-16	641155	26.09
Yukon	92-99	641125	26.99
Yukon	00-06	641155	26.09
Yukon (4 pin taillight plug)	07-14	641155	26.09
Yukon (5 pin taillight plug)	07-14	641155	26.09

- tires & wheels
- axles, hubs & springs
- tongue accessories
- hitches
- electrical
- brake parts
- trailer hardware
- locks & pins
- towing & loading
- tie downs
- tools
- chemicals

TRAILER

PLUG-IN SIMPLE!® VEHICLE SPECIFIC WIRING KIT 4 WIRE FLAT



- tires & wheels
- axles, hubs & springs
- tongue accessories
- hitches
- electrical
- brake parts
- trailer hardware
- locks & pins
- towing & loading
- tie downs
- tools
- chemicals

TRAILER

MODEL	YEAR	KIT PART #	
GMC CONTINUED			
Yukon (6 pin taillight plug)	07-14	641155	26.09
Yukon (4 pin taillight plug)	15	641155	26.09
Yukon (5 pin taillight plug)	15	641155	26.09
Yukon (6 pin taillight plug)	15	641155	26.09
HUMMER			
H2	03-07	641155	26.09
H2 SUT	03-07	641155	26.09
H2	08-09	641155	26.09
H2 SUT	08-09	641155	26.09
H3	06-09	641155	26.09
H3 SUT	09	641155	26.09
INFINITI			
QX56 (with tow package), QX80	04-15	641155	26.09
ISUZU			
Ascender	04-08	641155	26.09
I-280	06	641165	50.39
I-290	07-08	641165	50.39
I-350	06	641165	50.39
I-370	07-08	641165	50.39
JEEP			
Grand Cherokee (early 07)	05-07	642545	96.95
Liberty	02-07	642475	70.39
Cherokee (with tow package)	14-16	641155	26.09
Grand Cherokee (with tow package)	11-15	641155	26.09
Liberty (with tow package)	08-10	641155	26.09
Wrangler / Renegade	98-04	642615	36.59
Wrangler / Renegade	05-06	642625	37.09
Wrangler	07-16	642635	36.59
KIA			
Borrego (with tow package)	09	641155	26.09
Sportage	05-06	643925	64.95
LAND ROVER			
Range Rover (with tow package)	13-14	641155	26.09
LR4 (with tow package)	13-14	641155	26.09
LINCOLN			
Aviator (with factory 7 blade)	03-05	641155	26.09
Aviator (with factory 7 blade)	06	641155	26.09
Mark LT	06	641155	26.09
Mark LT	07-08	641155	26.09
MKT (with tow package)	09	641155	26.09
MKT (with tow package)	10-11	641155	26.09
MKT (with tow package)	12-14	641155	26.09
Navigator (with tow package)	99-12	641155	26.09
Navigator (with tow package)	13-15	641155	26.09
MAZDA			
Tribute (with tow package)	01-04	640445	20.49
Tribute (with tow package)	05-06	640455	20.49
MERCEDES BENZ			
M Class (with tow package)	98-05	641155	26.09
M Class (with tow package)	06-08	641155	26.09
M Class (with tow package)	09-14	641155	26.09
MERCURY			
Mariner (with tow package)	05-07	640455	20.49
Mountaineer (with factory 7 blade)	02-10	641155	26.09

MODEL	YEAR	KIT PART #	
MINI			
Cooper	06-08	642205	46.99
NISSAN			
Armada	04-15	641155	26.09
Frontier Pickup (with factory 4 flat)	05-11	643575	24.69
Pathfinder (with tow package)	05-09	643575	24.69
Pathfinder (with tow package)	13-15	641155	26.09
Titan	04-16	641155	26.09
Xterra	00-03	643595	21.49
Xterra	04	643595	21.49
Xterra (with factory 4 flat)	05-15	643575	24.69
OLDSMOBILE			
Bravada	02-04	641155	26.09
PLYMOUTH			
Voyager / Grand Voyager	91-95	642205	46.99
PONTIAC			
Aztek	01-05	641405	25.95
PORSCHE			
Cayenne (with tow package)	13-14	641155	26.09
RAM			
Ram 1500 (with tow package)	10-16	641155	26.09
Ram Pickup 2500/3500 (with tow package)	10-16	641155	26.09
Ram Promaster (with tow package)	14-15	641155	26.09
SAAB			
9-7X	05-10	641155	26.09
SATURN			
Outlook (with tow package)	07-10	641155	26.09
SUBARU			
B9 Tribeca	06-16	643855	117.95
Forester	98-08	643855	117.95
Impreza (Sedan)	02-07	643855	117.95
Legacy	03-08	643855	117.95
Outback	96-08	643855	117.95
SUZUKI			
Equator (with factory 4 flat)	09-12	643575	24.69
TOYOTA			
Pickup (except T-100)	84-95	643315	58.69
Sequoia (with tow package)	10-12	620415	19.69
		640955	44.99
		640965	43.59
		640975	53.39
Sequoia (with tow package)	10-12	641155	26.09
Sequoia (with tow package)	13-14	620415	19.69
		640955	44.99
		640965	43.59
		640975	53.39
Sequoia (with tow package)	13-14	641155	26.09
Tacoma	95-04	643315	58.69
Tacoma (without tow package)	05-08	643355	86.09
Tacoma (without tow package)	14-15	643355	86.09
T-100	93-98	643355	86.09
Tundra (with tow package)	03-06	643385	44.95
Tundra (with factory 7 blade)	14-15	641155	26.09
VOLKSWAGEN			
Touareg (with tow package)	12-15	641155	26.09

PLUG-IN SIMPLE!® MULTI-TOW



MODEL	YEAR	PLUG-IN SIMPLE!® VEHICLE SPECIFIC WIRING KIT
AUDI		
Q3 (with tow package)	09-15	620415, 640955, 640965, 640975
Q5 (with tow package)	09-14	620415, 640955, 640965, 640975
Q7 (with tow package)	07-15	620415, 640955, 640965, 640975
BUICK		
Enclave (with tow package)	08-12	640975
Enclave (with tow package)	13-16	620412, 620415, 640955, 640965, 640975
Rainier	04-07	620412, 620415, 640955, 640965, 640975
CADILLAC		
Escalade	02-06	620415, 640955, 640965, 640975
Escalade / EXT / ESV	07-13	620415, 640955, 640965, 640975
Escalade / EXT / ESV	14-15	620412, 620415, 640955, 640965, 640975
CHEVROLET		
Avalanche	02-06	620412, 620415, 640955, 640965, 640975
Avalanche (4 pin taillight plug)	07-13	620412, 620415, 640955, 640965, 640975
Avalanche (5 pin taillight plug)	07-13	620412, 620415, 640955, 640965, 640975
Avalanche (6 pin taillight plug)	07-13	620412, 620415, 640955, 640965, 640975
Colorado (with tow package)	08-12	620415, 640955, 640965, 640975
Colorado (with tow package)	15-16	620415, 640955, 640965, 640975
Express Van (with tow package)	08-16	620415, 640955, 640965, 640975
Silverado 1500	03-07	620412, 620415, 640955, 640965, 640975
Silverado 1500 (new body style)	07-13	620412, 620415, 640955, 640965, 640975
Silverado 2500/3500 (new body style)	99-02	620412, 620415, 640955, 640965, 640975
Silverado 2500/3500	03-07	620412, 620415, 640955, 640965, 640975
Silverado 2500/3500 (new body style)	07-13	620412, 620415, 640955, 640965, 640975
Silverado 1500, 2500, 3500	14-16	620415, 640955, 640965, 640975
Suburban	00-06	620412, 620415, 640955, 640965, 640975
Suburban (4 pin taillight plug)	07-13	620412, 620415, 640955, 640965, 640975
Suburban (5 pin taillight plug)	07-13	620412, 620415, 640955, 640965, 640975
Suburban (6 pin taillight plug)	07-13	620412, 620415, 640955, 640965, 640975
Suburban (4 pin taillight plug)	14	620412, 620415, 640955, 640965, 640975
Suburban (5 pin taillight plug)	14	620412, 620415, 640955, 640965, 640975
Suburban (6 pin taillight plug)	14	620412, 620415, 640955, 640965, 640975
Suburban (4 pin taillight plug)	15	620412, 620415, 640955, 640965, 640975
Suburban (5 pin taillight plug)	15	620412, 620415, 640955, 640965, 640975
Suburban (6 pin taillight plug)	15	620412, 620415, 640955, 640965, 640975
Tahoe	00-06	620415, 640955, 640965, 640975
Tahoe (4 pin taillight plug)	07-13	620412, 620415, 640955, 640965, 640975
Tahoe (5 pin taillight plug)	07-13	620412, 620415, 640955, 640965, 640975
Tahoe (6 pin taillight plug)	07-13	620412, 620415, 640955, 640965, 640975
Tahoe (4 pin taillight plug)	14	620412, 620415, 640955, 640965, 640975
Tahoe (5 pin taillight plug)	14	620412, 620415, 640955, 640965, 640975
Tahoe (6 pin taillight plug)	14	620412, 620415, 640955, 640965, 640975
Tahoe (4 pin taillight plug)	15	620412, 620415, 640955, 640965, 640975
Tahoe (5 pin taillight plug)	15	620412, 620415, 640955, 640965, 640975
Tahoe (6 pin taillight plug)	15	620412, 620415, 640955, 640965, 640975
Trailblazer	02-09	620412, 620415, 640955, 640965, 640975
Traverse (with tow package)	10-12	620415, 640955, 640965, 640975
Traverse (with tow package)	13-16	620412, 620415, 640955, 640965, 640975
CHRYSLER		
Aspen (with tow package)	Early 07	642145, 620416
Aspen (with tow package)	07-09	620415, 640955, 640965, 640975
Pacifica (with tow package)	03-08	642145, 620416
DODGE		
Dakota (with tow package)	00-10	642145, 620416
Durango (with tow package) (early 07)	00-07	642145, 620416
Durango (with tow package)	07-15	620415, 640955, 640965, 640975
Journey (with tow package)	09-10	620415, 640955, 640965, 640975
Nitro (with tow package)	07-09	620415, 640955, 640965, 640975
Ram 1500 (with tow package)	00-09	642145, 620416
Ram 1500 (with tow package)	10-16	620415, 640955, 640965, 640975
Ram Pickup 2500/3500 (with tow package)	00-09	642145, 620416

tires & wheels

axles, hubs & springs

tongue accessories

hitches

electrical

brake parts

trailer hardware

locks & pins

towing & loading

tie downs

tools

chemicals

TRAILER

PLUG-IN SIMPLE!® MULTI-TOW



MODEL	YEAR	PLUG-IN SIMPLE!® VEHICLE SPECIFIC WIRING KIT
DODGE CONTINUED		
Ram Pickup 2500/3500 (with tow package)	10-16	620415, 640955, 640965, 640975
Ram Promaster (with tow package)	14-16	620415, 640955, 640965, 640975
Ram Van	01-03	642145, 620416
Sprinter (with tow package)	04-08	642145, 620416
Sprinter 2500	09	642145, 620416
Sprinter 3500	09	642145, 620416
FORD		
Econoline Van (with factory 7 blade)	04-15	620415, 640955, 640965, 640975
Escape (with tow package)	13-16	620415, 640955, 640965, 640975
Excursion	00-05	620415, 640955, 640965, 640975
Expedition (with factory 7 blade)	99-15	620415, 640955, 640965, 640975
Explorer (with factory 7 blade)	02-16	620415, 640955, 640965, 640975
Explorer Sport Trac (with tow package)	07-10	620415, 640955, 640965, 640975
F-150 (with tow package)	08-15	620415, 640955, 640965, 640975
F-250, 350 (with tow package)	05-16	620415, 640955, 640965, 640975
Flex (with tow package)	09-15	620415, 640955, 640965, 640975
Transit T-150 Van (with tow package)	15-16	620415, 640955, 640965, 640975
Transit T-250 Wagon (with tow package)	15-16	620415, 640955, 640965, 640975
Transit T-350 Wagon XLT (with tow package)	15-16	620415, 640955, 640965, 640975
GMC		
Acadia (with tow package)	07-12	620415, 640955, 640965, 640975
Acadia (with tow package)	13-16	620412, 620415, 640955, 640965, 640975
Canyon (with tow package)	08-12	620415, 640955, 640965, 640975
Canyon (with tow package)	15-16	620415, 640955, 640965, 640975
Denali	01-14	620412, 620415, 640955, 640965, 640975
Envoy (with tow package)	02-09	620412, 620415, 640955, 640965, 640975
Sierra 1500	03-07	620412, 620415, 640955, 640965, 640975
Sierra 1500 (new body style)	07-13	620412, 620415, 640955, 640965, 640975
Sierra 2500/3500 (new body style)	99-02	620412, 620415, 640955, 640965, 640975
Sierra 2500/3500	03-07	620412, 620415, 640955, 640965, 640975
Sierra 2500/3500 (new body style)	07-13	620412, 620415, 640955, 640965, 640975
Sierra 1500, 2500, 3500	14-16	620415, 640955, 640965, 640975
Savana Van (full size) (with tow package)	08-16	620415, 640955, 640965, 640975
Yukon	00-06	620412, 620415, 640955, 640965, 640975
Yukon (4 pin taillight plug)	07-14	620412, 620415, 640955, 640965, 640975
Yukon (5 pin taillight plug)	07-14	620412, 620415, 640955, 640965, 640975
Yukon (6 pin taillight plug)	07-14	620412, 620415, 640955, 640965, 640975
Yukon (4 pin taillight plug)	15	620412, 620415, 640955, 640965, 640975
Yukon (5 pin taillight plug)	15	620412, 620415, 640955, 640965, 640975
Yukon (6 pin taillight plug)	15	620412, 620415, 640955, 640965, 640975
HUMMER		
H2	03-07	620415, 640955, 640965, 640975
H2 SUT	03-07	620415, 640955, 640965, 640975
H2	08-09	620415, 640955, 640965, 640975
H2 SUT	08-09	620415, 640955, 640965, 640975
H3	06-09	620415, 640955, 640965, 640975
H3 SUT	09	620415, 640955, 640965, 640975
INFINITI		
QX56 (with tow package), QX80	04-15	620415, 640955, 640965, 640975
ISUZU		
Ascender	04-08	620412, 620415, 640955, 640965, 640975
JEEP		
Cherokee (with tow package)	14-16	620415, 640955, 640965, 640975
Commander (with tow package)	06-10	642145, 620416
Grand Cherokee (with tow package)	00-04	642145, 620416
Grand Cherokee (with tow package) (early 07)	05-07	642145, 620416
Grand Cherokee (with tow package)	07-10	642145, 620416
Grand Cherokee (with tow package)	11-15	620415, 640955, 640965, 640975
Liberty (with tow package)	04-07	642145, 620416
Liberty (with tow package)	08-10	620415, 640955, 640965, 640975
Wrangler / Renegade (with tow package)	04-16	642145, 620416

tires & wheels
axles, hubs & springs
tongue accessories
hitches
electrical
brake parts
trailer hardware
locks & pins
towing & loading
tie downs
tools
chemicals

TRAILER

PLUG-IN SIMPLE!® MULTI-TOW



MODEL	YEAR	PLUG-IN SIMPLE!® VEHICLE SPECIFIC WIRING KIT
KIA		
Borrego (with tow package)	09	620415, 640955, 640965, 640975
LAND ROVER		
Range Rover (with tow package)	13-14	620415, 640955, 640965, 640975
LR4 (with tow package)	13-14	620415, 640955, 640965, 640975
LINCOLN		
Aviator (with factory 7 blade)	03-05	620415, 640955, 640965, 640975
Aviator (with factory 7 blade)	06	620415, 640955, 640965, 640975
Mark LT	06	620415, 640955, 640965, 640975
Mark LT	07-08	620415, 640955, 640965, 640975
MKT (with tow package)	09	620415, 640955, 640965, 640975
MKT (with tow package)	10-11	620415, 640955, 640965, 640975
MKT (with tow package)	12-14	620415, 640955, 640965, 640975
Navigator (with tow package)	99-12	620415, 640955, 640965, 640975
Navigator (with tow package)	13-15	620415, 640955, 640965, 640975
MERCEDES BENZ		
GL Class (with tow package)	07-10	642145, 620416
M Class (with tow package)	98-05	620415, 640955, 640965, 640975
M Class (with tow package)	06-14	620415, 640955, 640965, 640975
MERCURY		
Mountaineer (with factory 7 blade)	02-10	620415, 640955, 640965, 640975
MITSUBISHI		
Raider (with tow package)	06-08	642145, 620416
NISSAN		
Armada	04-15	620415, 640955, 640965, 640975
Pathfinder (with tow package)	13-15	620415, 640955, 640965, 640975
Titan	04-16	620415, 640955, 640965, 640975
OLDSMOBILE		
Bravada	02-04	620412, 620415, 640955, 640965, 640975
PORSCHE		
Cayenne (with tow package)	13-14	620415, 640955, 640965, 640975
RAM		
Ram 1500 (with tow package)	10-16	620415, 640955, 640965, 640975
Ram Pickup 2500/3500 (with tow package)	10-16	620415, 640955, 640965, 640975
Ram Promaster (with tow package)	14-15	620415, 640955, 640965, 640975
Ram Tradesman Van (with tow package)	14-15	642145, 620416
SAAB		
9-7X	05-10	620412, 620415, 640955, 640965, 640975
SATURN		
Outlook (with tow package)	07-10	620412, 620415, 640955, 640965, 640975
TOYOTA		
Sequoia (with tow package)	03-04	620421
Tundra (with factory 7 blade)	07-12	643395
Tundra (with factory 7 blade)	13	643395
Tundra (with factory 7 blade)	14-15	620415, 640955, 640965, 640975
VOLKSWAGEN		
Touareg (with tow package)	12-15	620415, 640955, 640965, 640975

tires & wheels

axles, hubs & springs

tongue accessories

hitches

electrical

brake parts

trailer hardware

locks & pins

towing & loading

tie downs

tools

chemicals

TRAILER

BASIC WIRING SOLUTIONS



ENDURANCE™

PROFESSIONAL WIRING SERIES

Maximum Durability

Superior Ergonomics

3-Year Warranty
Industry's Best

VEHICLE SIDE

- Reinforced easy-grip lid
- Lid opens 180 degrees for easier connections
- Internal seals for ultimate weatherproofing
- Long life oversized hinge
- Mounting bracket, hardware, and terminal grease packet included

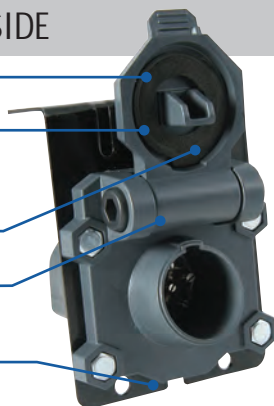

TRAILER SIDE

- Ergonomic pistol grip
- Corrosion resistant terminals
- Mounting bracket, hardware, and terminal grease packet included



7 RV BLADE



PART #
648480 23.19

6 POLE ROUND



PART #
648420 18.29

7 RV BLADE



PART #
648500 18.59

6 POLE ROUND



PART #
648440 17.09

TRAILER

MULTI-TOW® CONNECTOR 7 RV BLADE, 5 AND 4 WIRE FLAT

- Industry's best, 3 year warranty with maximum durability and superior ergonomics
- Oversized hinge and reinforced easy-grip lid opens 180 degrees for easier connections
- Best corrosion resistance, internal seals and rear cover for ultimate weatherproofing



ENDURANCE™

PART #
648470 39.69

4 WIRE FLAT Y-HARNES (20 FT.)

- Wishbone design allows for wire extension to both taillights
- Heavy duty connector housings with easy-pull grip and built-in mounting holes
- Protective nylon wire sleeving, heat-shrink tubing and serrated ground terminal for proper grounding



ENDURANCE™

PART #
648240 28.89

5 WIRE FLAT VEHICLE AND TRAILER CONNECTORS

- Industry's best, 3 year warranty with maximum durability and superior ergonomics
- Heavy duty connector housings with easy-pull grip and built-in mounting holes
- Protective nylon wire sleeving and heat-shrink tubing



PART #	DESCRIPTION
647900	14.69 Vehicle End - 48" (A)
647910	11.79 Trailer End - 18' (B)
647890	22.95 Set - 1 each

ACCESSORIES



tires & wheels
axles, hubs & springs
tongue accessories
hitches
electrical
brake parts
trailer hardware
locks & pins
towing & loading
tie downs
tools
chemicals

TRAILER

6 POLE MOLDED TRAILER CABLE



(6-14 gauge wires.)

PART #	LENGTH
620033	27.95 4 Feet
620034	37.95 6 Feet

7 RV BLADE MOLDED TRAILER CABLE



(2-10 gauge; 1-12 gauge; 4-14 gauge wires.)

PART #	LENGTH
620042	30.95 3 Feet
620044	46.95 6 Feet
620048	67.95 11 Feet

7 RV BLADE MOLDED TRAILER CABLE



(With retail packaging. 2-10 gauge; 1-12 gauge; 4-14 gauge wires.)

PART #	LENGTH
620244	50.95 6 Feet
620248	72.95 11 Feet

3/8" CONVOLUTED TUBING 10'

- Plastic sheathing protects wires from the elements
- Easily slips over wires
- 10 feet



PART #	LENGTH
639035	6.89 10 Feet

1/2" CONVOLUTED TUBING 7'

- Plastic sheathing protects wires from the elements
- Easily slips over wires
- 7 feet



PART #	LENGTH
639045	6.79 7 Feet

4, 5, 6, POLE, KNOCKOUT MOUNTING BRACKET



PART #	DESCRIPTION
648605	6.69 Mounting Bracket

MAG-FLAT™ BRACKET

- Magnetic bracket keeps 4-wire flat out of harm's way
- Attaches to any metal surface



PART #	DESCRIPTION
648095	6.39 Mag-Flat™

7, 9 POLE MOUNTING BRACKET



PART #	DESCRIPTION
648615	6.69 Mounting Bracket

4-WIRE FLAT MOUNTING BRACKET



PART #	DESCRIPTION
648595	5.29 Mounting Bracket

4-WIRE FLAT WEATHERPROOF DUST COVERS

Includes 2 tow vehicle end dust covers and terminal grease packet.



PART #	DESCRIPTION
648735	4.09 4-Wire Flat - Pair

FLAT-LITE™ 4-WIRE FLAT LED DUST COVER

Tests left turn/brake, right turn/brake and tail/marker lights.



PART #	DESCRIPTION
648675	7.89 Dust Cover

4-WIRE FLAT MOUNTING BOX

Neatly stores the 4-wire flat out of harm's way.



PART #	DESCRIPTION
648755	10.49 Mounting Box

4-WIRE FLAT TESTER



With LED indicator lights. Tests left turn/brake, right turn/brake and tail/ marker lights. Red LED light will glow if connection is correct.

PART #	DESCRIPTION
648655	7.89 Flat Tester

4-WIRE FLAT TESTER WITH 6 TO 12-VOLT CIRCUIT TESTER

With LED indicator lights. Tests left turn/brake, right turn/brake and tail/ marker lights. Red LED light will glow if connection is correct.



◀ 4-wire flat tester and 6 to 12-volt circuit tester also available separately ▶

PART #	DESCRIPTION
648715	11.39 Flat/Circuit Testers

6 TO 12-VOLT CIRCUIT TESTER

- L.E.D. lights up when power is found
- Alligator clip for easy attachment
- Multi-use application



PART #	DESCRIPTION
648705	5.29 Circuit Tester

FAST SAME DAY SHIPPING

ELECTRICAL

ALL PRODUCT SHOWN IS RETAIL READY AND ALL WIRES ARE COLOR CODED

4-WIRE FLAT CONNECTORS



4-WIRE VEHICLE END

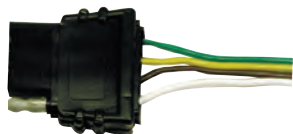

PART #	LENGTH	MANUFACTURER
648015	4.09 12"	Hopkins
648035	6.79 48"	Hopkins
OP242	5.92 48"	Optronics
PM5400B	9.81 48"	Peterson

4-WIRE TRAILER END

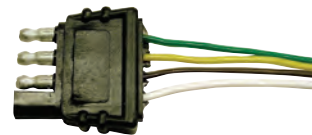

PART #	LENGTH	MANUFACTURER
648115	4.59 12"	Hopkins
648135	6.89 48"	Hopkins
PM5400A	10.60 12"	Peterson

4-WIRE EXTENSION



PART #	LENGTH	MANUFACTURER
648145	7.99 12"	Hopkins
647115	12.19 48"	Hopkins
PM5401	16.44 30"	Peterson

4-WIRE TRAILER "Y" HARNESS



PART #	LENGTH	MANUFACTURER
648245	23.59 20'	Hopkins
648255	25.19 25'	Hopkins
648265	29.39 30'	Hopkins
OP250	24.87 25'	Optronics
PM5425	28.58 25'	Peterson

5-WIRE FLAT CONNECTORS



5-WIRE VEHICLE END

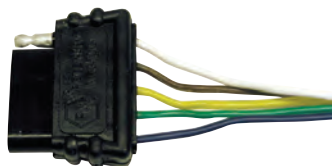

PART #	LENGTH	MANUFACTURER
647905	12.39 48"	Hopkins
OP252	5.33 48"	Optronics

5-WIRE TRAILER END



PART #	LENGTH	MANUFACTURER
647915	10.79 18"	Hopkins

5-WIRE TRAILER "Y" HARNESS

PART #	LENGTH	MANUFACTURER
OP255	24.32 25'	Optronics



TRAILER

4-WIRE MATCHED SET

- 1 each 48" vehicle end & 12" trailer end
- Clamshell packaged



648215 10.59

5-WIRE MATCHED SET

- 1 each 48" vehicle end & 18" trailer end
- Clamshell packaged



647895 19.95



BASIC WIRING SOLUTIONS • 4-WIRE FLATS

A 4-wire flat is the most commonly used trailer plug. This plug is found on small boat, utility, jet ski, snowmobile and small camper trailers where right turn/brake, left turn/brake, tail/marker lights and ground is needed.

4-WIRE FLAT EXTENSIONS

DESCRIPTION	PART #	
32" 4-WIRE FLAT MODULAR REPLACEMENT This unit is included in most T-connector kits. Utilizes an exterior vehicle frame ground.	647105	13.49
48" 4-WIRE FLAT EXTENSION Extends wiring system 48" for more flexibility. Passes through vehicle ground.	647115	12.19
12" 4-WIRE FLAT EXTENSION	648145	7.99
10 FT. 4-WIRE FLAT EXTENSION	648235	17.99



647105

4-WIRE FLAT VEHICLE/TRAILER SETS

DESCRIPTION	PART #	
12" TOW VEHICLE END AND 12" TRAILER END SET Includes 6 splice connectors.	648165	6.69
12" TOW VEHICLE END AND 12" TRAILER END SET	648175	5.39
QUICK-FIX™ FLAT Repairs/replaces damaged 4-wire flat.	648195	9.79
48" TOW VEHICLE END AND 12" TRAILER END SET Includes 6 splice connectors.	648205	9.09
48" TOW VEHICLE END AND 12" TRAILER END SET	648215	10.59

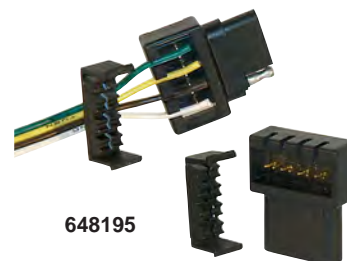

648195

4-WIRE FLAT VEHICLE END



4-WIRE FLAT
12" VEHICLE END

DESCRIPTION	PART #	
12" TOW VEHICLE END Includes 3 splice connectors.	648005	4.09
12" TOW VEHICLE END	648015	4.09
48" TOW VEHICLE END Includes 3 splice connectors.	648025	7.79
ENDURANCE™ 48" TOW VEHICLE END	648030	10.09
48" TOW VEHICLE END	648035	6.79
60" TOW VEHICLE END	648045	5.49
LED 48" TOW VEHICLE END W/L.E.D. Verify vehicle-side wiring is correct Integrated "easy-pull" grip.	648055	10.49
4-WIRE FLAT TOW VEHICLE END KNOCKOUT CONNECTOR For use with 1.25" hole diameter or #648605 bracket.	648065	9.09
UNIVERSAL KIT Complete with 3 splices and circuit tester, 48" vehicle end, grease, nylon ties.	646105	21.09



648030

4-WIRE FLAT TRAILER END

DESCRIPTION	PART #	
12" TRAILER END Includes 3 splice connectors.	648105	5.29
ENDURANCE™ 12" TRAILER END	648110	7.29
48" TRAILER END Includes 3 splice connectors.	648125	6.69
48" TRAILER END	648135	6.89
20 FT. TRAILER Y-HARNESS	648245	23.59
25 FT. TRAILER Y-HARNESS	648255	25.19
30 FT. TRAILER Y-HARNESS	648265	29.39

4-WIRE FLAT
12" TRAILER END



648105



648110



648255



648245
648265



648125

- tires & wheels
- axles, hubs & springs
- tongue accessories
- hitches
- electrical
- brake parts
- trailer hardware
- locks & pins
- towing & loading
- tie downs
- tools
- chemicals

TRAILER

FAST SAME DAY SHIPPING

BASIC WIRING SOLUTIONS • 5-WIRE FLATS



48" VEHICLE END AND 18" TRAILER END Matched set.

PART # 647895 19.95

48" VEHICLE END

PART # 647905 12.39

18" TRAILER END

PART # 647915 10.79



647905

647915

48" **ENDURANCE™** VEHICLE END AND 18" TRAILER END

Matched set

647890 22.95

48" **ENDURANCE™** VEHICLE END

647900 14.69

18" **ENDURANCE™** TRAILER END

647910 11.79



647900

647910

4 POLE ROUNDS

4-pole rounds are used in many of the same applications that the 4-wire flat is used. However, 4-pole rounds do not possess an industry standard wiring code.

4 POLE ROUND CONNECTOR KIT Contains matched set plug and socket, mounting bracket, wire, splices and mounting hardware.

648285 14.49

TOW VEHICLE END SOCKET

648305 10.19

TRAILER END PLUG

648325 8.29

MOUNTING BRACKET

648605 6.69

4 POLE MATCHED SET ONLY Socket and plug

648295 12.59



4 POLE MATCHED SET
PART # 648295 9.10



648325



648605



648305

5 POLE ROUNDS

5-pole rounds provide one additional function not found in 4-poles. This extra function is typically used for electric brakes, auxiliary or backup function.



5 POLE ROUND CONNECTOR KIT Contains matched set plug and socket, mounting bracket, wire, splices and mounting hardware.

648345 17.09

TOW VEHICLE END SOCKET

648365 9.19

TRAILER END PLUG

648385 9.19

MOUNTING BRACKET

648605 6.69



648385



648605



648365

6 POLE ROUNDS

6-pole rounds provide two additional functions not found in 4-poles. These functions are electric brakes and an auxiliary power lead. The most common use for this type of plug is for horse trailers.

6 POLE ROUND CONNECTOR KIT Contains matched set metal plug and plastic socket, mounting bracket, wire, splices and mounting hardware.

648405 19.69

ENDURANCE™ TOW VEHICLE END SOCKET

648420 18.29

TOW VEHICLE END SOCKET Plastic

648425 9.69

TOW VEHICLE END SOCKET Metal

648435 15.79

ENDURANCE™ TRAILER END PLUG

648440 17.09

TRAILER END PLUG Metal

648445 11.49

MOUNTING BRACKET

648605 6.69



648420

648445

648440

648435

648605

648425

TRAILER



HEAVY-DUTY CONNECTORS

1 POLE TRAILER SIDE



PART #
652002 26.25

4 POLE VEHICLE SIDE



PART #
652004 10.59

4 POLE TRAILER SIDE



PART #
652006 7.89

6 POLE MATCHED SET



PART #
652007 22.49

6 POLE TRAILER SIDE



(With cable protector)

PART #
652008 11.89

7-WAY PIN-TYPE VEHICLE SIDE



PART #
652016 21.09

7-WAY PIN-TYPE TRAILER SIDE



PART #
652024 21.09

7-WAY PIN-TYPE TRAILER SIDE

(With cable protector)



PART #
652027 23.69

OTHER CONNECTORS

3 POLE FLAT SET

(12")



PART #
637935 3.69

2 POLE IN-LINE SET

(5/16")



PART #
647945 4.89

4 POLE IN-LINE SET



PART #
647955 6.39

2 POLE FLAT SET

(12")



PART #
647965 4.09

4 POLE SQUARE SET

(24")

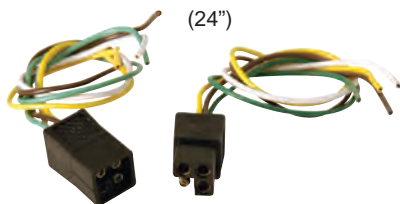

PART #
647975 4.89

5 POLE SQUARE SET

(24")

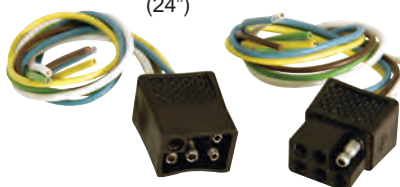

PART #
647985 7.29

6 POLE SQUARE SET

(24")



PART #
647995 7.99



ELECTRICAL CONNECTORS

- No cutting, splicing or taping
- Solid one piece construction
- 16 gauge bonded wire with 4-flat plug
- Simple do-it-yourself instructions on every package
- It's quick and easy - just plug in the 'T' one connector and you are ready to tow

MAKE/MODEL	YEAR	PART #	
FORD			
Aerostar Van	96 & earlier	DT18251	17.50
MERCURY			
Sable (Sedan Only)	92-95	DT18351	17.50



FAST SAME DAY SHIPPING

tires & wheels
axles, hubs & springs
tongue accessories
hitches
electrical
brake parts
trailer hardware
locks & pins
towing & loading
tie downs
tools
chemicals

TRAILER

TAILLIGHT CONVERTERS



WHICH CONVERTER DO I NEED?



POWER TAILLIGHT CONVERTER

These units completely isolate the tow vehicle from trailer malfunctions. Power is taken directly from the battery for isolation and brighter trailer headlights. Each unit can power up to 2 sets of stop/turn signals (8.0 amps) on the trailer.

SHORT-PROOF POWER TAILLIGHT CONVERTER

Protects tow vehicle electronics and itself from wiring shorts. Self-resetting.

PART #	MFG #
646365	46365 107.95

Short circuit protected. Can power up to 8.0 amps per output.



NEGATIVE INPUT SHORT-PROOF POWER TAILLIGHT CONVERTER

Protects tow vehicle electronics and itself from wiring shorts. Self-resetting.

PART #	MFG #
646345	46345 107.95

Short circuit protected. Can power up to 8.0 amps per output.



ELECTRONIC TAILLIGHT CONVERTER

Electronic taillight converters adapt an independent bulb taillight system of the tow vehicle to the common bulb taillight system of the trailer. Each unit can power 2.1 amps per stop/turn signal.

UNIVERSAL KIT

Complete with splices and circuit tester.



PART #	MFG #	PRICE
646155	46155	41.59

TAILLIGHT CONVERTER

Recommended for repairing a damaged taillight converter.



PART #	MFG #	PRICE
648845	48845	19.89

TAILLIGHT CONVERTER

Double-molded weatherproof design.



PART #	MFG #	PRICE
648915	48915	24.29

HEAVY DUTY TAILLIGHT CONVERTER

Double-molded weatherproof design. Converter mounts in trunk out of harm's way.



PART #	MFG #	PRICE
648925	48925	31.95

VEHICLE TOWING VEHICLE TAILLIGHT ISOLATING KIT

Permanently installs on towed vehicle near taillights.

PART #	MFG #	PRICE
648955	48955	34.29



TRAILER

- tires & wheels
- axles, hubs & springs
- tongue accessories
- hitches
- electrical
- brake parts
- trailer hardware
- locks & pins
- towing & loading
- tie downs
- tools
- chemicals



VEHICLE WIRING KITS

NO CUTTING! NO SPLICING! SAVES TIME!

Unplug your vehicle's factory wiring harness and plug in a Hopkins® vehicle wiring kit. That's how easy trailer wiring is with a Plug-In-Simple!® wiring kit, featuring OEM connectors for a perfect, weather-tight fit! These kits provide a 4-wire flat connector for your trailer. Optional "pre-wired" 4-wire flat to 6 pole round and 4-wire flat to 7 RV blade round extension adapters are available to custom install the vehicle side wiring to most trailer configurations.

MULTI-TOW® PLUG-IN SIMPLE!® T-CONNECTORS

TOYOTA/LEXUS MULTI-TOW® MULTI-TOW® 7:4

Tundra 2003-07
Sequoia 2006-08
4-Runner 2004-09
GX470 2004-09

- Provides 7 RV blade and 4-wire flat towing!
- Fits standard 7 RV blade bracket

PART #	MFG #	
643385	43385	44.95

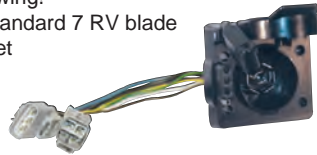

TOYOTA MULTI-TOW® MULTI-TOW® 7:4

(non-retail packaging)
Tundra 2008-10

- Provides 7 RV blade and 4-wire flat towing!
- Fits standard 7 RV blade bracket

PART #	MFG #	
643395	11143395	46.29



TOYOTA Sequoia (w/factory 2003-2004 - 7 way)

- Plug-In Simple!® Wiring Kit: No cutting, No splicing- Saves time
- Includes dust cover, cable ties and grease packet

PART #	MFG #	
620421	11143384	46.99



TOYOTA MULTI-TOW® MULTI-TOW® 7:4

- Plug-In Simple!® Wiring Kit: No cutting, No splicing- Saves time
- Utilizes OEM connectors- enhanced fit and weatherproofing

PART #	MFG #	
620420	11143325	43.49



Multi-Tow® Connectors give you the ability to tow trailers with different wiring connectors from the same vehicle connector. These connectors simply replace the 7-way connector that came with your vehicle.

MULTI-TOW® 7:4 DODGE/CHRYSLER/JEEP/MERCEDES/MITSUBISHI

- Multi-Tow® provides multiple towing options from one connector
- Plug-In Simple!®: No cutting, No splicing- Saves time
- Utilizes OEM connectors- enhanced fit and weatherproofing
- Applies to over 10 different vehicle applications equipped with a factory tow package
- Impact and corrosion resistant
- Includes dust cover and mounting bracket

PART #	MFG #	
642145	42145	43.69



MULTI-TOW® 7:4 FORD/CHEVY/GMC

- Multi-Tow® provides multiple towing options from one connector
- Provides sockets for towing both 7 RV Blade and 4 Wire Flat trailers
- Plug-In Simple!®: No cutting, No splicing- Saves time
- Utilizes OEM connectors create an exact fit and maximum weatherproofing
- Applies to over 30 different vehicle applications equipped with a factory tow package
- Impact and corrosion resistant
- Includes dust cover and mounting bracket

PART #	MFG #	
640955	40955	44.99



MULTI-TOW® 6:4 FORD/CHEVY/GMC

- Multi-Tow® provides 6 Pole Round and 4 Wire Flat towing options from one connector
- Plug-In Simple!®: No cutting, No splicing- Saves time
- Utilizes OEM connectors- enhanced fit and weatherproofing
- Applies to over 30 different vehicle applications equipped with a factory tow package
- Impact and corrosion resistant- Includes dust cover and mounting bracket

PART #	MFG #	
640965	40965	43.59



MULTI-TOW® 7:4 FORD/CHEVY/GMC (OEM REPLACEMENT)

- Multi-Tow® provides 7 RV Blade and 4 Wire Flat towing options from one connector
- Plug-In Simple!®: No cutting, No splicing- Saves time
- Utilizes OEM connectors- enhanced fit and weatherproofing
- Applies to over 30 different vehicle applications equipped with a factory tow package
- Impact and corrosion resistant
- 2-Door connector protection
- Includes unique snap-fit bracket

PART #	MFG #	
640975	40975	53.39



UNIVERSAL MULTI-TOW® HARNESS

- For use with 640955, 640965, 640975
- Used to retro-fit GM trucks between 1999-2002 to allow use of the GM OE plug connector. Plugs directly into the above Multi-Tow applications.
- Splices onto vehicles' wiring system.
- Allows for Multi-Tow® installation on any vehicle.

PART #	MFG #	
640985	40985	32.89



SEE APPLICATION ON FOLLOWING PAGES

FAST SAME DAY SHIPPING

tires & wheels
axles, hubs & springs
tongue accessories
hitches
electrical
brake parts
trailer hardware
locks & pins
towing & loading
tie downs
tools
chemicals

TRAILER

MULTI-TOW® PLUG-IN-SIMPLE!® T-CONNECTORS

ENDURANCE™ TWIST-MOUNT 7 BLADE

The Endurance™ Twist-Mount 7 Blade Connector is compatible with GM tow vehicles from 2000 to the current year. Incorporating Endurance design features enables this connector to last for years of trouble-free use.

- Exact O.E.M. Fit
- Plug-In Simple!® for quick and easy installation or replacement



PART #	MFG #	
620412	40930	19.69

ENDURANCE™

FORD / CHEVY / GMC (OEM REPLACEMENT)

- Compatible with Ford, GM and other popular tow vehicles
- Plug-In Simple!® for quick and easy installation or replacement
- Durable lid opens 180 degrees
- Ultimate weatherproofing



PART #	MFG #	
620415	40940	19.69

ENDURANCE™ DODGE/CHRYSLER/JEEP OEM QUICK-INSTALL™ WIRING KIT

- Allows for Dodge trucks to adapt to the Quick-Install™ 7 RV Blade
- Reinforced lid opens 180 degrees to prevent breaking
- Ultimate weatherproofing



PART #	MFG #	
620416	42190	40.95

MODEL	YEAR	PART #
AUDI		
Q3 (w/ tow pkg)	09-15	620415, 640955, 640965, 640975
Q5 (w/ tow pkg)	09-14	620415, 640955, 640965, 640975
Q7 (w/ tow pkg)	07-15	620415, 640955, 640965, 640975
BUICK		
Enclave (w/ tow pkg)	08-15	620412, 620415, 640955, 640965, 640975
Rainier	04-07	620412, 620415, 640955, 640965, 640975
CADILLAC		
Escalade	02-15	620412, 620415, 640955, 640965, 640975
CHEVROLET		
Avalanche	02-13	620412, 620415, 640955, 640965, 640975
Colorado (w/ tow pkg)	15	620412, 620415, 640955, 640965, 640975
Colorado (w/ tow pkg)	08-12	620412, 620415, 640955, 640965, 640975
Express Van (w/ tow pkg)	03-15	620412, 620415, 640955, 640965, 640975
Silverado 1500	03-13	620412, 620415, 640955, 640965, 640975
Silverado 1500, 2500, 3500	14-15	620412, 620415, 640955, 640965, 640975
Silverado 2500/3500 (New body style)	99-13	620412, 620415, 640955, 640965, 640975
Suburban	00-15	620412, 620415, 640955, 640965, 640975
Tahoe	00-15	620412, 620415, 640955, 640965, 640975
Trailblazer	02-09	620412, 620415, 640955, 640965, 640975
Traverse (w/ tow pkg)	10-15	620412, 620415, 640955, 640965, 640975
CHRYSLER		
Aspen (w/ tow pkg)	07-09	620415, 640955, 640965, 640975
Aspen (w/ tow pkg)	Early 07	642145, 620416
Pacifica (w/ tow pkg)	03-08	642145, 620416

MODEL	YEAR	PART #
DODGE		
Dakota (w/ tow pkg)	00-10	642145, 620416
Durango (w/ tow pkg)	07-15	620415, 640955, 640965, 640975
Durango (w/ tow pkg) (Early 07)	00-07	642145, 620416
Journey (w/ tow pkg)	09-10	620415, 640955, 640965, 640975
Nitro (w/ tow pkg)	07-09	620415, 640955, 640965, 640975
Ram 1500 (w/ tow pkg)	00-09	642145, 620416
Ram 1500 (w/ tow pkg) see also Ram	10-15	620415, 640955, 640965, 640975
Ram Pickup 2500/3500 (w/ tow pkg)	00-09	642145, 620416
Ram Pickup 2500/3500 (w/ tow pkg) see also Ram	10-15	620415, 640955, 640965, 640975
Ram Promaster (w/ tow pkg) see also Ram	14-15	620415, 640955, 640965, 640975
Ram Van	01-03	642145, 620416
Sprinter (w / tow pkg)	04-08	642145, 620416
Sprinter 2500	09	642145, 620416
Sprinter 3500	09	642145, 620416
FORD		
Econoline Van (w/ factory 7 blade)	04-14	620415, 640955, 640965, 640975
Escape (w/ tow pkg)	13-15	620415, 640955, 640965, 640975
Excursion	00-05	620415, 640955, 640965, 640975
Expedition (w/ factory 7 blade)	99-14	620415, 640955, 640965, 640975
Explorer (w/ factory 7 blade)	02-15	620415, 640955, 640965, 640975
Explorer Sport Trac (w/ tow pkg)	07-10	620415, 640955, 640965, 640975
F-150 (w/ tow pkg)	08-15	620415, 640955, 640965, 640975
F-250, 350 (w/ tow pkg)	08-15	620415, 640955, 640965, 640975
Transit T-150 Van (w/ tow)	15	620415, 640955, 640965, 640975
Transit T-250 Wagon (w/ tow)	15	620415, 640955, 640965, 640975
Transit T-350 Wagon XLT (w/ tow)	15	620415, 640955, 640965, 640975

MULTI-TOW® PLUG-IN-SIMPLE® T-CONNECTORS

MODEL	YEAR	PART #
GMC		
Acadia (w/ tow pkg)	07-15	620412, 620415, 640955, 640965, 640975
Canyon (w/ tow pkg)	15	620412, 620415, 640955, 640965, 640975
Canyon (w/ tow pkg)	08-12	620412, 620415, 640955, 640965, 640975
Denali	01-14	620412, 620415, 640955, 640965, 640975
Envoy (w/ tow pkg)	02-09	620412, 620415, 640955, 640965, 640975
Savana Van (full size) (w/ tow pkg)	09-15	620412, 620415, 640955, 640965, 640975
Sierra 1500	99-13	620412, 620415, 640955, 640965, 640975
Sierra 1500, 2500, 3500	14-15	620412, 620415, 640955, 640965, 640975
Sierra 2500/3500	03-13	620412, 620415, 640955, 640965, 640975
Yukon	00-15	620412, 620415, 640955, 640965, 640975
HUMMER		
H2	03-09	620412, 620415, 640955, 640965, 640975
H3	06-09	620412, 620415, 640955, 640965, 640975
INFINITI		
QX56 (w/ tow pkg), QX80	04-15	620415, 640955, 640965, 640975
ISUZU		
Ascender	04-08	620412, 620415, 640955, 640965, 640975
JEEP		
Cherokee (w/ tow pkg)	14-15	620415, 640955, 640965, 640975
Commander (w/ tow pkg)	06-10	642145, 620416
Grand Cherokee (w/ tow pkg)	00-04	642145, 620416
Grand Cherokee (w/ tow pkg)	07-10	642145, 620416
Grand Cherokee (w/ tow pkg)	11-15	620415, 640955, 640965, 640975
Grand Cherokee (w/ tow pkg) (Early 07)	05-07	642145, 620416
Liberty (w/ tow pkg)	04-07	642145, 620416
Liberty (w/ tow pkg)	08-10	620415, 640955, 640965, 640975
Wrangler / Renegade (w/ tow pkg)	04-06	642145, 620416
Wrangler / Renegade (w/ tow pkg)	07-15	642145, 620416
KIA		
Borrego (w/ tow pkg.)	09	620415, 640955, 640965, 640975
LAND ROVER		
LR4 (w/ tow pkg)	13-14	620415, 640955, 640965, 640975
Range Rover (w/ tow pkg)	13-14	620415, 640955, 640965, 640975

MODEL	YEAR	PART #
LINCOLN		
Aviator (w/ factory 7 blade)	03-06	620415, 640955, 640965, 640975
Mark LT	06-08	620415, 640955, 640965, 640975
MKT (w/ tow pkg)	09	620415, 640955, 640965, 640975
MKT (w/ tow pkg)	10-14	620415, 640955, 640965, 640975
Navigator (w/ tow pkg)	99-15	620415, 640955, 640965, 640975
MERCEDES BENZ		
GL Class (w/ tow pkg)	07-10	642145, 620416
M Class (w/ tow pkg)	98-14	620415, 640955, 640965, 640975
MERCURY		
Mountaineer (w/ factory 7 blade)	02-10	620415, 640955, 640965, 640975
MITSUBISHI		
Raider (w/ tow pkg)	06-08	642145, 620416
NISSAN		
Armada	04-15	620415, 640955, 640965, 640975
Pathfinder (w/ tow pkg)	13-15	620415, 640955, 640965, 640975
Titan	04-15	620415, 640955, 640965, 640975
OLDSMOBILE		
Bravada	02-04	620412, 620415, 640955, 640965, 640975
PORSCHE		
Cayenne (w/ tow pkg.)	13-14	620415, 640955, 640965, 640975
RAM		
Ram 1500 (w/ tow pkg)	10-15	620415, 640955, 640965, 640975
Ram Pickup 2500/3500 (w/ tow pkg)	10-15	620415, 640955, 640965, 640975
Ram Promaster (w/ tow pkg)	14-15	620415, 640955, 640965, 640975
Ram Tradesman Van (w/ tow pkg)	14-15	642145, 620416
SAAB		
9-7X	05-10	620412, 620415, 640955, 640965, 640975
SATURN		
Outlook (w/ tow pkg)	07-10	620415, 640955, 640965, 640975
TOYOTA		
Sequoia (w/ tow pkg)	10-14	620415, 640955, 640965, 640975
Tundra (w/ factory 7 blade)	14-15	620415, 640955, 640965, 640975
VOLKSWAGEN		
Touareg (w/ tow pkg)	12-15	620415, 640955, 640965, 640975

tires & wheels

axles, hubs & springs

tongue accessories

hitches

electrical

brake parts

trailer hardware

locks & pins

towing & loading

tie downs

tools

chemicals

TRAILER

4-WIRE FLAT MULTI-TOW® PLUG-IN-SIMPLE!® T-CONNECTORS

tires & wheels
axles, hubs & springs
tongue accessories
hitches
electrical
brake parts
trailer hardware
locks & pins
towing & loading
tie downs
tools
chemicals

TRAILER



641125



641155



643355



643575



642205



642105



643855



643915

APPLICATION	YEAR	PART #	
AUDI			
Q3 (w/ tow pkg)	09-15	641155	26.09
Q5 (w/ tow pkg)	09-14	641155	26.09
Q7 (w/ tow pkg)	07-15	641155	26.09
BUICK			
Enclave (w/ tow pkg)	08-15	641155	26.09
Rainier	04-07	641155	26.09
Rendezvous	02-07	641405	25.95
CADILLAC			
Escalade	02-15	641155	26.09
Escalade	99-00	641125	26.99
CHEVROLET			
Avalanche	02-13	641155	26.09
Blazer (full size)	92-94	641125	26.99
Colorado	04-12	641165	50.39
Colorado (w/ tow pkg)	08-12	641155	26.09
Colorado (w/ tow pkg)	15	641155	26.09
Express Van (w/ tow pkg)	03-15	641155	26.09
Pickup (full size)	88-98	641125	26.99
Pickup C/K (Old body style)	99-00	641125	26.99
Silverado 1500	03-13	641155	26.09
Silverado 1500 (New Body)	99-02	641145	42.99
Silverado 1500, 2500, 3500	14-15	641155	26.09
Silverado 2500/3500 (New body style)	99-13	641155	26.09
Suburban	92-99	641125	26.99
Suburban	00-15	641155	26.09
Tahoe	95-99	641125	26.99
Tahoe	00-15	641155	26.09
Trailblazer	02-09	641155	26.09
Traverse (w/ tow pkg)	10-15	641155	26.09
CHRYSLER			
Aspen	07-09	642245	73.59
Aspen (w/ tow pkg)	07-09	641155	26.09
Town & Country	91-95	642205	46.99
Town & Country	04-07	642235	47.09
DODGE			
Caravan / Grand Caravan	91-95	642205	46.99
Caravan / Grand Caravan	04-07	642235	47.09
Dakota	04-11	642205	46.99
Durango	04-09	642245	73.59
Durango (w/ tow pkg)	07-15	641155	26.09
Journey (w/ tow pkg)	09-10	641155	26.09
Nitro (w/ tow pkg)	07-09	641155	26.09
Ram 1500 (w/ tow pkg) see also Ram	10-15	641155	26.09

APPLICATION	YEAR	PART #	
DODGE CONTINUED			
Ram Pickup 1500	02-06	642135	71.49
Ram Pickup 1500	07-09	642205	46.99
Ram Pickup 2500/3500	03-06	642135	71.49
Ram Pickup 2500/3500	07-09	642205	46.99
Ram Pickup 2500/3500 (w/ tow pkg) see also Ram	10-15	641155	26.09
Ram Promaster (w/ tow pkg) see also Ram	14-15	641155	26.09
FORD			
Econoline Van (w/ factory 7 blade)	04-14	641155	26.09
Escape (w/ tow pkg)	01-04	640445	20.49
Escape (w/ tow pkg)	05-07	640455	20.49
Escape (w/ tow pkg)	13-15	641155	26.09
Excursion	00-05	641155	26.09
Expedition (w/ factory 7 blade)	99-14	641155	26.09
Explorer	06-10	640345	22.99
Explorer (w/ factory 4 flat)	02-05	640335	22.99
Explorer (w/ factory 7 blade)	02-15	641155	26.09
Explorer Sport Trac (w/ tow pkg)	07-10	641155	26.09
F-150 (w/ tow pkg)	08-15	641155	26.09
F-250 Heavy Duty, F-350	02-04	640165	23.49
F-250 Heavy Duty, F-350	05-07	640195	37.09
F-250, 350 (w/ tow pkg)	08-15	641155	26.09
Flex (w/ tow pkg)	09-15	641155	26.09
Transit T-150 Van (w/ tow)	15	641155	26.09
Transit T-250 Wagon (w/ tow)	15	641155	26.09
Transit T-350 Wagon XLT (w/ tow)	15	641155	26.09
GMC			
Acadia (w/ tow pkg)	07-15	641155	26.09
Canyon	04-07	641165	50.39
Canyon (w/ tow pkg)	08-12	641155	26.09
Canyon (w/ tow pkg)	15	641155	26.09
Canyon (w/o tow pkg)	08-12	641165	50.39
Denali	99-00	641125	26.99
Denali	01-14	641155	26.09
Envoy (w/ tow pkg)	02-09	641155	26.09
Jimmy (full size)	92-94	641125	26.99
Pickup (Classic) (Old body style)	99-00	641125	26.99
Savana Van (full size) (w/ tow pkg)	09-15	641155	26.09
Sierra 1500	03-13	641155	26.09
Sierra 1500 (New body style)	99-02	641155	26.09
Sierra 1500 (New body style)	99-02	641145	42.99
Sierra 1500, 2500, 3500	14-15	641155	26.09
Sierra 2500/3500	03-13	641155	26.09
Yukon	92-99	641125	26.99
Yukon	00-15	641155	26.09

4-WIRE FLAT MULTI-TOW® PLUG-IN-SIMPLE!® T-CONNECTORS

APPLICATION	YEAR	PART #	
HUMMER			
H2	03-09	641155	26.09
H3	06-09	641155	26.09
HYUNDAI			
Santa Fe	01-06	643805	58.95
Tucson	05-09	643815	64.95
INFINITI			
QX56 (w/ tow pkg), QX80	04-15	641155	26.09
ISUZU			
Ascender	04-08	641155	26.09
I-280	06	641165	50.39
I-290	07-08	641165	50.39
I-350	06	641165	50.39
I-370	07-08	641165	50.39
JEEP			
Cherokee (w/ tow pkg)	14-15	641155	26.09
Grand Cherokee (Early 07)	05-07	642545	96.95
Grand Cherokee (w/ tow pkg)	11-15	641155	26.09
Liberty	02-07	642475	70.39
Liberty (w/ tow pkg)	08-10	641155	26.09
Wrangler	07-15	642635	36.59
Wrangler / Renegade	98-04	642615	36.59
Wrangler / Renegade	05-06	642625	37.09
KIA			
Borrego (w/ tow pkg.)	09	641155	26.09
Sportage	05-06	643925	64.95
LAND ROVER			
LR4 (w/ tow pkg)	13-14	641155	26.09
Range Rover (w/ tow pkg)	13-14	641155	26.09
LINCOLN			
Aviator (w/ factory 4 flat)	03-05	640335	22.99
Aviator (w/ factory 7 blade)	03-06	641155	26.09
Mark LT	06-08	641155	26.09
MKT (w/ tow pkg)	09-14	641155	26.09
Navigator (w/ tow pkg)	99-15	641155	26.09
MAZDA			
Tribute (w/ tow pkg)	01-06	640445	20.49
MERCEDES BENZ			
M Class (w/ tow pkg)	98-14	641155	26.09
MERCURY			
Mariner (w/ tow pkg)	05-07	640455	20.49
Mountaineer (w/ factory 4 flat)	02-05	640335	22.99
Mountaineer (w/ factory 7 blade)	02-10	641155	26.09
MITSUBISHI			
Raider	06-08	642205	46.99

APPLICATION	YEAR	PART #	
NISSAN			
Armada	04-15	641155	26.09
Frontier Pickup (w/ tow pkg)	05-11	643575	24.69
Pathfinder (w/ tow pkg)	13-15	641155	26.09
Pathfinder (w/ tow pkg)	05-09	643575	24.69
Titan	04-15	641155	26.09
Xterra	00-04	643595	21.49
Xterra (w/ factory 4 flat)	05-15	643575	24.69
OLDSMOBILE			
Bravada	02-04	641155	26.09
PLYMOUTH			
Voyager / Grand Voyager	91-95	642205	46.99
PONTIAC			
Aztek	01-05	641405	25.95
PORSCHE			
Cayenne (w/ tow pkg.)	13-14	641155	26.09
RAM			
Ram 1500 (w/ tow pkg)	10-15	641155	26.09
Ram Pickup 2500/3500 (w/ tow pkg)	10-15	641155	26.09
Ram Promaster (w/ tow pkg)	14-15	641155	26.09
SAAB			
9-7X	05-10	641155	26.09
SATURN			
Outlook (w/ tow pkg)	07-10	641155	26.09
SUBARU			
B9 Tribeca	06-14	643855	117.95
Forester	98-08	643855	117.95
Impreza (Sedan)	02-07	643855	117.95
Legacy	03-08	643855	117.95
Outback	96-08	643855	117.95
SUZUKI			
Equator (w/ factory 4 flat)	09-12	643575	24.69
TOYOTA			
Pickup (except T-100)	84-95	643315	58.69
Sequoia (w/ tow pkg)	10-13	641155	26.09
Sequoia (w/ tow pkg)	14	641155	26.09
Sequoia (w/ tow pkg) (MT)	05-09	620420	43.49
Sequoia (w/ tow pkg) (MT)	03-04	620421	46.99
T-100	93-98	643355	86.09
Tacoma	95-04	643315	58.69
Tacoma (w/o tow pkg)	05-15	643355	86.09
Tundra (w/ factory 7 blade)	07-13	643395	46.29
Tundra (w/ tow pkg)	03-06	643385	44.95
Tundra (w/ factory 7 blade)	14-15	641155	26.09
VOLKSWAGEN			
Touareg (w/ tow pkg)	12-15	641155	26.09

tires & wheels

axles, hubs & springs

tongue accessories

hitches

electrical

brake parts

trailer hardware

locks & pins

towing & loading

tie downs

tools

chemicals

TRAILER



ACCESSORIES



TRAILER WIRING INSTALLATION KIT - 42 PIECES

- Everything needed to rewire a trailer
- Ideal for Y-harness and 4 conductor wire installation
- Includes specialty tool: 6-12V L.E.D. circuit tester



PART #	MFG #	PRICE
651000	51020	14.49



TOWING DELUXE ELECTRICAL ACCESSORIES KIT - 100 PIECES

- Everything needed for installation, maintenance and repair of vehicle and trailer wiring
- Ideal for all basic wiring, Y-harness, T-connector and 4 conductor wire installation
- Includes specialty tools: multi-purpose wire tool, terminal cleaner, grit sandpaper cloth and 6-12V L.E.D. circuit tester



PART #	MFG #	PRICE
651020	51020	27.49



UNIVERSAL BATTERY CONNECTORS



MFG #	DESCRIPTION	PART #	PRICE
118634	Tap/Ground Kit, Side Mount With 22-16 Gauge Terminals	444306	11.95



444310



40 AMP. MAXI-FUSE®

MFG #	PART #	PRICE
38654	444310	1.95



IN LINE FUSE HOLDER WIRE TAPS (25 PACK)



MFG #	DESCRIPTION	PART #	PRICE
18099-025	In-line Fuse Holder wire taps (self-stripping) for use w/32v maximum - 20 amp maximum bayonet type fuses & 14 to 18 gauge wire (25 pack)	444307	59.95

TRAILER



BONDED WIRE



GAUGE	DESCRIPTION	PART #	PRICE
14 GAUGE	4-wire bonded (25 feet)	649905	38.59



GAUGE	DESCRIPTION	PART #	PRICE
16 / 18 GAUGE	4-wire bonded (25 feet)	649915	29.59



GAUGE	DESCRIPTION	PART #	PRICE
16 / 18 GAUGE	4-wire bonded (100 feet spool)	649955	77.79

GAUGE	DESCRIPTION	PART #	PRICE
12 GAUGE	2-wire bonded (Black/blue, 100 feet spool)	649975	108.79

PLUG-IN SIMPLE!® BACKUP CAMERA



HASSLE-FREE HOOKUPS!

EASILY ALIGN BALL TO TRAILER EVERY TIME!

SMART HITCH™ Camera and Sensor System

- Allows for one person to hitch by themselves
- No Splicing! Plugs in behind tow package connector
- Large, 3.5" color monitor with static free image
- Camera with SmartZone™ sensors



MODEL	YEAR	PART #
CADILLAC		
Escalade	02-06	620414 211.79
Escalade / EXT / ESV	07-13	620414 211.79
Escalade / EXT / ESV	14	620414 211.79
Escalade / EXT / ESV	15	620414 211.79
CHEVROLET		
Avalanche	02-06	620414 211.79
Avalanche (4 pin taillight plug)	07-13	620414 211.79
Avalanche (5 pin taillight plug)	07-13	620414 211.79
Avalanche (6 pin taillight plug)	07-13	620414 211.79
Colorado (with tow package)	08-12	620414 211.79
Colorado (with tow package)	15-16	620414 211.79
Silverado 1500	03-07	620414 211.79
Silverado 1500 (new body style)	07-13	620414 211.79
Silverado 2500/3500 (new body style)	99-02	620414 211.79
Silverado 2500/3500 (new body style)	99-02	620414 211.79
Silverado 2500/3500	03-07	620414 211.79
Silverado 2500/3500 (new body style)	07-13	620414 211.79
Silverado 1500, 2500, 3500	14-16	620414 211.79
Suburban	00-02	620414 211.79
Suburban	00-02	620414 211.79
Suburban	03-06	620414 211.79
Suburban (4 pin taillight plug)	07-13	620414 211.79
Suburban (5 pin taillight plug)	07-13	620414 211.79
Suburban (6 pin taillight plug)	07-13	620414 211.79
Suburban (4 pin taillight plug)	14	620414 211.79
Suburban (5 pin taillight plug)	14	620414 211.79
Suburban (6 pin taillight plug)	14	620414 211.79
Suburban (4 pin taillight plug)	15	620414 211.79
Suburban (5 pin taillight plug)	15	620414 211.79
Suburban (6 pin taillight plug)	15	620414 211.79
Tahoe	00-02	620414 211.79
Tahoe	03-06	620414 211.79
Tahoe (4 pin taillight plug)	07-13	620414 211.79
Tahoe (5 pin taillight plug)	07-13	620414 211.79
Tahoe (6 pin taillight plug)	07-13	620414 211.79
Tahoe (4 pin taillight plug)	14	620414 211.79
Tahoe (5 pin taillight plug)	14	620414 211.79
Tahoe (6 pin taillight plug)	14	620414 211.79
Tahoe (4 pin taillight plug)	15	620414 211.79
Tahoe (5 pin taillight plug)	15	620414 211.79
Tahoe (6 pin taillight plug)	15	620414 211.79
DODGE		
Ram 1500 (with tow package)	10-12	620414 211.79
Ram 1500 (with tow package)	13-14	620414 211.79
Ram 1500 (with tow package)	15-16	620414 211.79
Ram Pickup 2500/3500 (with tow package)	10-12	620414 211.79
Ram Pickup 2500/3500 (with tow package)	13-14	620414 211.79
Ram Pickup 2500/3500 (with tow package)	15-16	620414 211.79

MODEL	YEAR	PART #
FORD		
Excursion	00-05	620414 211.79
Explorer (with factory 7 blade)	14-16	620414 211.79
Explorer Sport Trac (with tow package)	07-10	620414 211.79
F-150 (with tow package)	08	620414 211.79
F-150 (with tow package)	09-14	620414 211.79
F-150 (with tow package)	15	620414 211.79
F-250, 350 (with tow package)	05-07	620414 211.79
F-250, 350 (with tow package)	08-16	620414 211.79
Flex (with tow package)	09-11	620414 211.79
Flex (with tow package)	12-14	620414 211.79
GMC		
Canyon (with tow package)	08-12	620414 211.79
Canyon (with tow package)	15-16	620414 211.79
Denali	01-06	620414 211.79
Denali	07-13	620414 211.79
Denali	14	620414 211.79
Sierra 1500	03-07	620414 211.79
Sierra 1500 (new body style)	07-13	620414 211.79
Sierra 2500/3500 (new body style)	99-02	620414 211.79
Sierra 2500/3500	03-07	620414 211.79
Sierra 2500/3500 (new body style)	07-13	620414 211.79
Sierra 1500, 2500, 3500	14-16	620414 211.79
Savana Van (full size) (with tow package)	08-16	620414 211.79
Yukon	00-06	620414 211.79
Yukon (4 pin taillight plug)	07-14	620414 211.79
Yukon (5 pin taillight plug)	07-14	620414 211.79
Yukon (6 pin taillight plug)	07-14	620414 211.79
Yukon (4 pin taillight plug)	15	620414 211.79
Yukon (5 pin taillight plug)	15	620414 211.79
Yukon (6 pin taillight plug)	15	620414 211.79
LINCOLN		
Mark LT	06	620414 211.79
Mark LT	07-08	620414 211.79
NISSAN		
Armada	04-15	620414 211.79
Titan	04-16	620414 211.79
RAM		
Ram 1500 (with tow package)	10-12	620414 211.79
Ram 1500 (with tow package)	13-14	620414 211.79
Ram 1500 (with tow package)	15-16	620414 211.79
Ram Pickup 2500/3500 (with tow package)	10-12	620414 211.79
Ram Pickup 2500/3500 (with tow package)	13-14	620414 211.79
Ram Pickup 2500/3500 (with tow package)	15-16	620414 211.79
TOYOTA		
Tundra (with factory 7 blade)	14-15	620414 211.79

- tires & wheels
- axles, hubs & springs
- tongue accessories
- hitches
- electrical
- brake parts
- trailer hardware
- locks & pins
- towing & loading
- tie downs
- tools
- chemicals

TRAILER

VEHICLE AND TRAILER WIRING CODES

IMPORTANT - Identify the wires on your vehicle and trailer by function only. Color coding is not standard among all manufacturers. Illustrations represent the rear views of the connectors

- tires & wheels
- axles, hubs & springs
- tongue accessories
- hitches
- electrical
- brake parts
- trailer hardware
- locks & pins
- towing & loading
- tie downs
- tools
- chemicals

VEHICLE SIDE

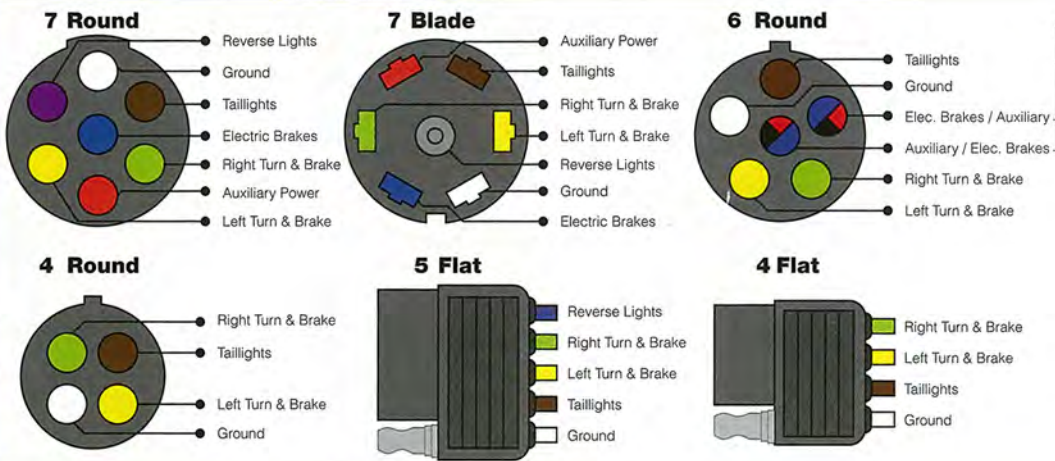

Brake and Auxiliary Power have two different industry standards. Identify which way your trailer is wired before wiring connectors.

TRAILER SIDE

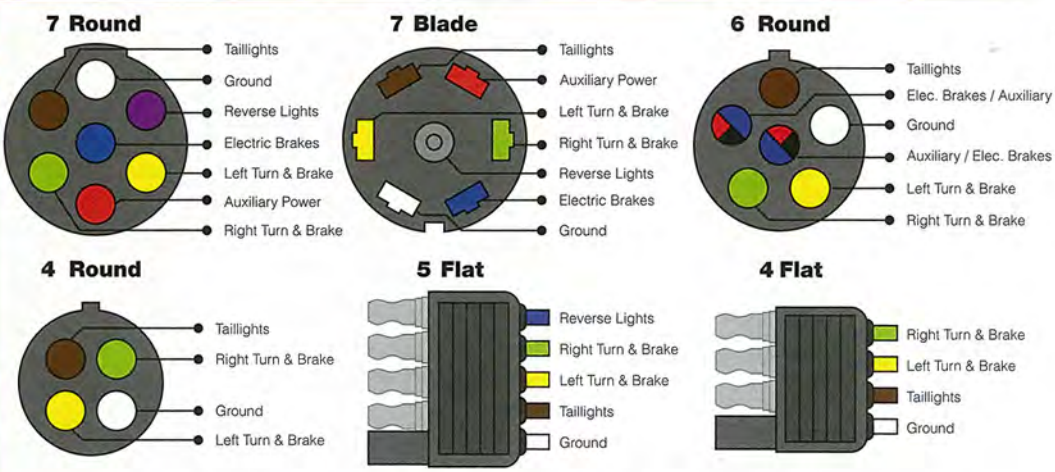

Brake and Auxiliary Power have two different industry standards. Identify which way your trailer is wired before wiring connectors.

HOPKINS® MODEL NO. 48240, 48245, 48255, 48265 TRAILER WIRING DIAGRAM

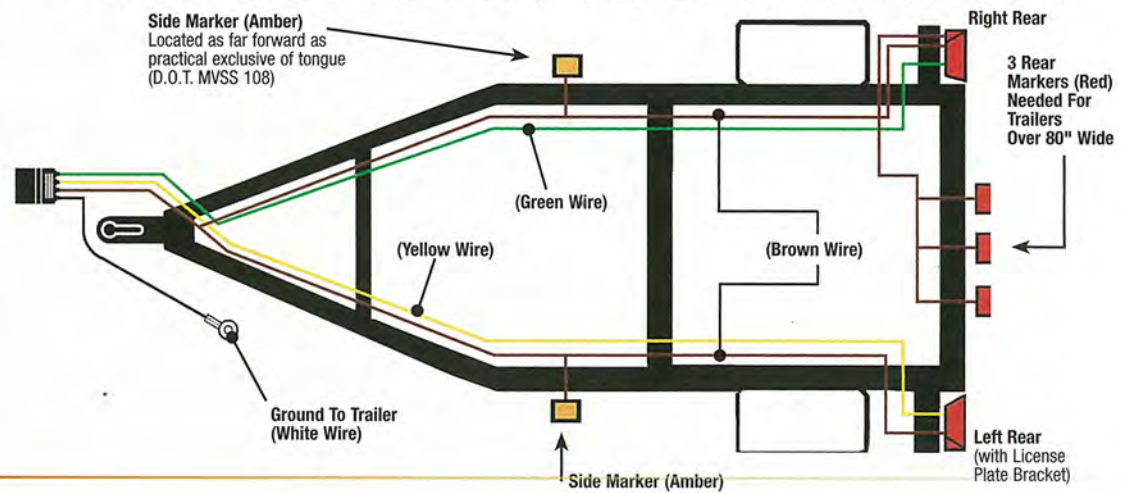



AUTOMATIC
DISTRIBUTORS

TRAILER CATALOG

BRAKE
PARTS

- tires & wheels
- axles, hubs & springs
- tongue accessories
- hitches
- electrical
- brake parts
- trailer hardware
- locks & pins
- towing & loading
- tie downs
- tools
- chemicals

BRAKE CONTROL INFORMATION

CROSS-REFERENCE BRAKE CONTROL WIRING GUIDE

WIRE FUNCTIONS		12 VOLTS	STOPLIGHT	GROUND	TRAILER BRAKES	ILLUMINATION				
BRAKE CONTROL WIRE COLOR		BLACK	RED	WHITE	BLUE	NOT USED				
MAKE	MODEL - YEAR	VEHICLE OEM WIRE COLOR								
CHEVY / GMC	2007 (New Body Style) - 2013	RED	LIGHT BLUE	WHITE	WHITE	DARK BLUE	BROWN			
CHEVY / GMC	1999 - 2007 (Classic Body Style)	RED	LIGHT BLUE	BLACK	BLACK	DARK BLUE	BROWN			
DODGE	2009-2012	RED	YELLOW	WHITE	VIOLET	BLACK	DRK GREEN	DARK GREEN		
DODGE	2003-2008	RED	WHITE	BLUE	WHITE	BLACK	GREEN	BLUE		
DODGE	1997-2002	RED	WHITE	WHITE	BLACK	BLACK	BLUE	BLUE		
FORD	F-250 / 350 2009-2013	RED	BROWN	BLUE	ORANGE	BLACK	GRAY	BLUE		
FORD	F-150 2009-2013	RED	OR RED GRAY	GREEN	OR YEL GRN	WHITE	BROWN	BLUE		
FORD	F-150 1994-2008	RED	RED	LIGHT GREEN	LIGHT GREEN	WHITE	WHITE	DARK BLUE	BROWN	
TOYOTA / LEXUS	2003-2012	BLACK	BLACK	GREEN	YELLOW	BLACK	WHITE	BLUE	RED	GREEN

BE SAFE, BE LEGAL!

If your gross trailer weight exceeds the limit, a braking system is required.*

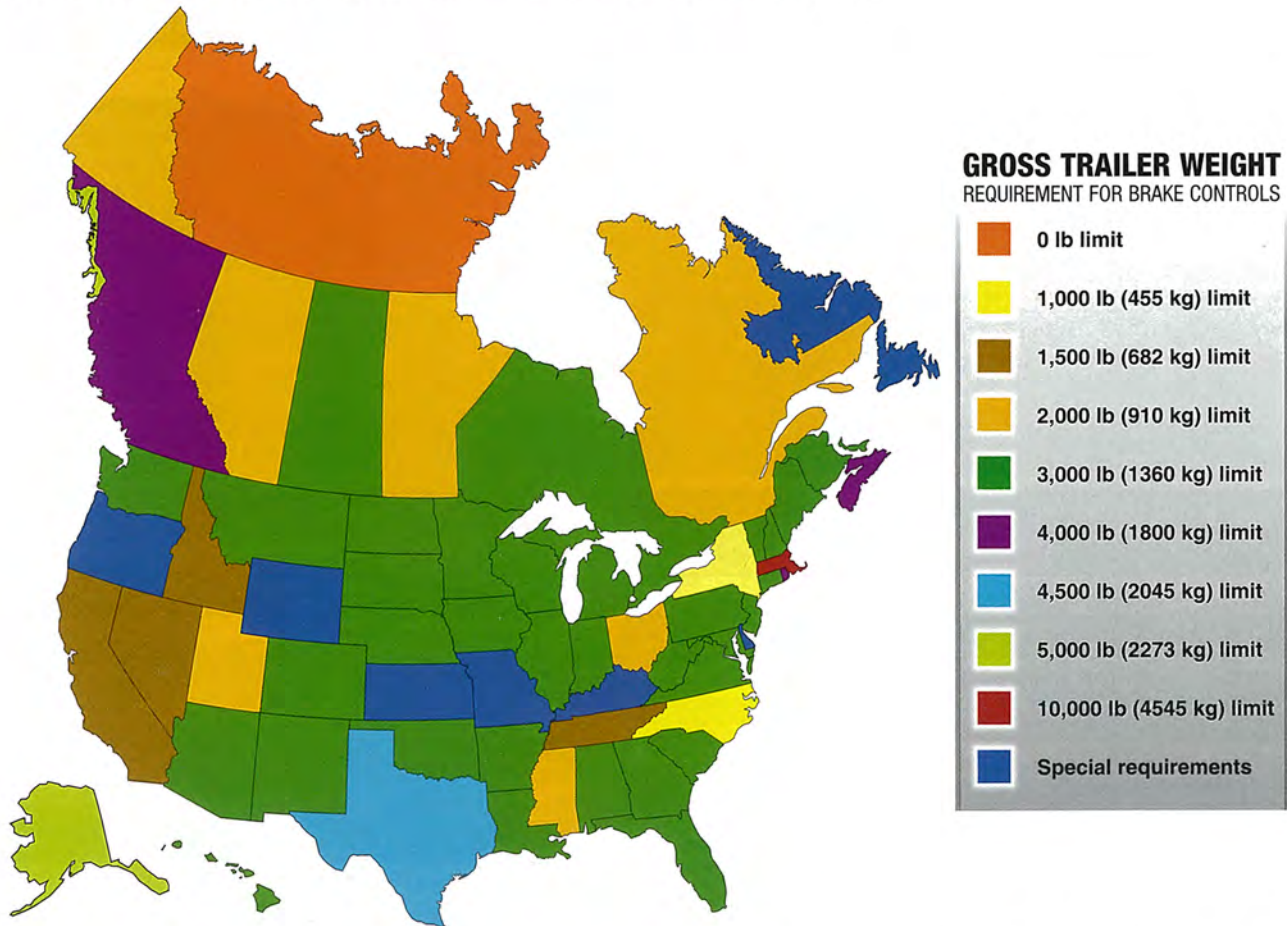

TRAILER

*Contact your department of transportation for complete towing law information



INDUSTRY LEADING TRAILER BRAKE CONTROLS

PRODIGY® P2 **ADVANCED INTELLIGENCE**

- Reverse battery protection for both vehicle and breakaway
- Designed to work with electric over hydraulic brake systems
- Numerous mounting options – including 360 degree vertical rotation
- Digital display depicts voltage delivery to trailer during braking
- No level adjustment necessary – adjusts to varying terrain as you drive
- Great for backing into tough spots! Works proportionally in reverse - with the ability to disable when not needed
- Produces stops that are in proportion to vehicle's deceleration rate
- "Boost" feature gives users the ability to apply more initial trailer braking power when towing heavier trailers
- Continual diagnostics check for proper connection, shorted magnet conditions and much more
- Quick and easy disconnect feature allows user to remove and store the control when not in use
- Electric trailer brake control for up to 4 braking axles
- Limited lifetime warranty (some conditions apply)
- Display boxed - complete as shown



890885 150.50



857686



857685



857894

ACCESSORIES FOR PRODIGY® P2

PART #	DESCRIPTION
857686	17.37 Dash Pocket Mounting Kit
857685	10.38 Mounting Bracket
857894	21.72 3 Ft. Pigtail Harness Kit

7-WAY TRAILER EMULATOR

7-Way Trailer Emulator is used for the proper installation and set-up of a brake control when a trailer is not readily available. Brake control set-up is accomplished using a built-in load module that will stimulate electric magnet brakes on a trailer. (The emulator will also check electrical continuity of all circuits in the 7-way blade style connector.)



856560 67.04

P3® **TAKING INNOVATION TO A WHOLE NEW LEVEL**

ACCESSORIES ONLY FOR P3®



855904



852178



855901



857894

PART #	DESCRIPTION
855904	5.20 Dash Mounting Clip Bracket
852178	7.98 Mounting Bracket Kit
857894	21.72 3 Ft. Pigtail Harness Kit
855901	7.65 T-Slot Bracket

tires & wheels

axles, hubs & springs

tongue accessories

hitches

electrical

brake parts

trailer hardware

locks & pins

towing & loading

tie downs

tools

chemicals

TRAILER



- tires & wheels
- axles, hubs & springs
- tongue accessories
- hitches
- electrical
- brake parts
- trailer hardware
- locks & pins
- towing & loading
- tie downs
- tools
- chemicals

PRIMUS™ IQ THE SMARTER BRAKING SOLUTION

Primus IQ is a totally proportional electric trailer brake control. This easy-to-set system allows the driver maximum flexibility when determining how the trailer should respond to a braking event. Snap-in dash mounting clip and removable electrical connector allow the unit to be quickly stored (or moved to another vehicle) when not in use.

- Works proportionally in reverse
- No level adjustment necessary, adjusts to varying terrain as you drive
- Digital display shows voltage to trailer during braking
- "The Original Boost" feature allows for customized braking
- Pre-assembled wire harness for simple hook-up and quick disconnect
- Diagnostic features incorporated in LED display
- Electric trailer brake control for up to 3 braking axles
- Limited lifetime warranty (some conditions apply)
- Display boxed - complete as shown



890160 155.29



856927

ACCESSORIES FOR PRIMUS™ IQ

PART #	DESCRIPTION
856927	7.87 Dash Mounting Kit

VOYAGER®

The Voyager incorporates Tekonsha's patented braking sensor and is the best value you'll find for smooth and secure trailer braking. It's compact size and features, like a bicolored LED brake monitor (to assure a complete connection to trailer brakes and give an indication of relative braking power being applied) make the Voyager extremely versatile. Voyager minimizes interference with tow vehicle electrical systems, uses a four wire hook up, has a broad setting range and is compatible with most any vehicle.

- Broad control range makes setting quick and easy
- As braking power is applied, the LED changes color gradually from green (completed circuit) to red, to indicate relative braking power
- Advanced electronics minimize false braking for smoother ride
- Electric trailer brake control for up to 4 braking axles
- 5-year limited warranty
- Display boxed - complete as shown



859030 129.25



852178

ACCESSORIES FOR VOYAGER®

PART #	DESCRIPTION
852178	7.98 Mounting Kit

TRAILER

REPLACEMENT WIRING HARNESS

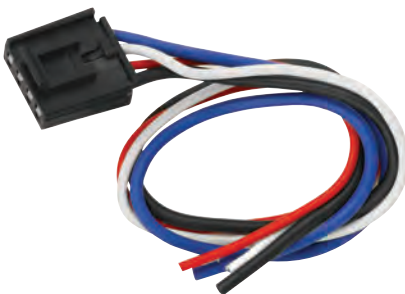

PART #	DESCRIPTION
444203	7.55 P3 90195, P2 90885, Primus IQ 12" Pigtail Harness
EACH	90160, I-Stop IQ 20191, 5520 Activator III, 83520 Brakeman Ultra
444204	97.24 P3 90195, P2 90885, Primus IQ 12" Pigtail Harness
12 PACK	90160, I-Stop IQ 20191, 5520 Activator III, 83520 Brakeman Ultra

Reese's timed brake controls are great choices for your basic economical light-duty towing needs. These time actuated controls have solid state electronics and can be mounted in any position - horizontal, vertical, even turned upside down.

REESE® BRAKEMAN® COMPACT

- 1 to 2 axle trailers Illuminated LED output indicator
- Slide adjustment output control
- "Up-front" manual over-ride control
- Mounting hardware included
- Smooth and simple installation
- 3 year limited warranty

444047 113.02



REESE® BRAKEMAN® IV

- 1 to 4 axle trailers
- Digital output indicator
- Small, compact design
- Up-front push buttons for Sync and Output
- Diagnostics for Overload, Open Ground
- Short Circuit Protected
- Mounts in any direction
- No leveling required
- Mounting hardware included
- Smooth and simple installation
- Plug & Play feature allows quick and easy connection
- Attractive point-of-purchase display packaging
- Lifetime limited warranty

444194 168.21



DRAW-TITE I-STOP™ IQ BRAKE CONTROL

A totally proportional electric trailer brake control, the new Draw-Tite I-Stop™IQ is self-leveling so no level adjustment is necessary.

Utilizing the primary sensor technology from Draw-Tite I-Stop™Ultra, the Draw-Tite I-Stop™IQ now includes the "Boost" feature that gives users the ability to apply more initial trailer braking when towing heavier trailers. It works proportionally in reverse for backing into tough spots and includes a snap-in dash mounting clip and removable electrical connector that allows the unit to be quickly stored when not in use. You will appreciate the digital readout depicting a secure electrical connection, amount of voltage delivery to the trailer brakes and diagnostic features incorporated in the LED display.

- Utilizes "Plug-N-Play" port for 2-plug adapters
- Self-diagnostics features will illuminate LED readout when issues occur
- Includes a "Boost" feature
- Works proportionally in reverse
- Snap-in dash mounting clip and hardware included
- Digital LED readout
- Snap-in mounting clip allows user to remove and store the control when not in use
- Limited lifetime warranty



444196 146.50

tires & wheels

axles, hubs & springs

tongue accessories

hitches

electrical

brake parts

trailer hardware

locks & pins

towing & loading

tie downs

tools

chemicals

TRAILER

- tires & wheels
- axles, hubs & springs
- tongue accessories
- hitches
- electrical
- brake parts
- trailer hardware
- locks & pins
- towing & loading
- tie downs
- tools
- chemicals



ACTIVATOR® IV BRAKE CONTROL

- 1 to 4 axle trailers
- Digital output indicator
- Small, compact design
- Up-front push buttons for Sync and Output
- Diagnostics for Overload, Open Ground
- Short Circuit Protected
- Mounts in any direction
- No leveling required
- Mounting hardware included
- Smooth and simple installation
- Plug & Play feature allows quick and easy connection
- Attractive point-of-purchase display packaging
- Lifetime limited warranty



444197 178.31



ACTIVATOR® BRAKE CONTROL

- 1 to 2 axle trailers
- Illuminated LED output indicator
- Slide adjustment output control
- "Up-front" manual over-ride control
- Mounting hardware included
- Smooth and simple installation Plug & Play feature allows quick and easy connection
- Attractive point-of-purchase display packaging
- 5 year limited warranty



444200 113.02



PILOT® BRAKE CONTROL

Pilot has a dark, smoke lens that is ideal for direct light applications, creating optimum visibility to read the large, two-digit display. Pilot has flexible mounting options and can be installed in any direction. Our microprocessor allows you the ability to read the display even when mounted upside down. The Pilot's digital display shows voltage output to the brakes.

- Large easy to read dual digital display shows:
- Properly wired control
- Voltage output to brakes (vs. a percentage)
- Connection to trailer
- Dark smoke lens ideal for direct light applications; performs better than red lens
- Protection against short circuit/loss of ground
- Microprocessor allows control to be mounted upside down and still have a readable display
- Standard mounting bracket included with optional ball mount available
- For use on any 12 volt negative ground system
- Plug & Play feature allows quick and easy connection
- Limited lifetime warranty



444201 138.97

TRAILER



All vehicle specific brake control wiring harnesses are available in 2-Plug styles and are clamshell packaged. 2-Plug units are designed for brake controls that have a wiring port built into the back of the unit. Simply plug the brake control end of the wiring harness into the back of the brake control and the vehicle end into the automobile's port. Brake controls that utilize the 2-plug style of wiring harness will be identified with the Plug & Play logo.



853035



853025
853015



853050



853034



853036



853020



853040



853065



853026



853070

MODEL	YEAR	POS	PART #	
BUICK				
Enclave w/Factory 7-Way	08-12	BP1	853026	26.66
CADILLAC				
Escalade	02	BP1	853025	22.01
Escalade	03-06	BP1	853015	21.67
Escalade ESV	03-06	BP1	853015	21.67
Escalade EXT	02	BP1	853025	22.01
Escalade EXT	03-06	BP1	853015	21.67
CHEVROLET				
Avalanche 1500	02	BP1	853025	22.01
Avalanche 1500	03-06	BP1	853015	21.67
Avalanche 2500	02	BP1	853025	22.01
Avalanche 2500	03-06	BP1	853015	21.67
Pickup, Silverado 1500 HD	01-02	BP1	853025	22.01
Pickup, Silverado 1500 HD	03-06	BP1	853015	21.67
Pickup, Silverado 1500 HD Classic Only	07	BP1	853015	21.67
Pickup, Silverado 1500 LD	99-02	BP1	853025	22.01
Pickup, Silverado 1500 LD	03-06	BP1	853015	21.67
Pickup, Silverado 1500 LD 5.8 ft. Bed, 2 & 4 WD (New Body Style)	14	BP2	444206	26.66
Pickup, Silverado 1500 LD 6.6 ft. Bed, 2 & 4 WD (New Body Style)	14	BP2	444206	26.66
Pickup, Silverado 1500 LD Classic Only	07	BP1	853015	21.67
Pickup, Silverado 2500 HD	01-02	BP1	853025	22.01
Pickup, Silverado 2500 HD	03-06	BP1	853015	21.67

MODEL	YEAR	POS	PART #	
CHEVROLET CONTINUED				
Pickup, Silverado 2500 HD Classic Only	07	BP1	853015	21.67
Pickup, Silverado 2500 LD	99-02	BP1	853025	22.01
Pickup, Silverado 2500 LD	03-04	BP1	853015	21.67
Pickup, Silverado 3500 Series	01-02	BP1	853025	22.01
Pickup, Silverado 3500 Series	03-06	BP1	853015	21.67
Pickup, Silverado 3500 Series Classic Only	07	BP1	853015	21.67
Suburban 1500	03-06	BP1	853015	21.67
Suburban 1500 New Body Style w/Amber Turn Signals	00-02	BP1	853025	22.01
Suburban 2500	03-06	BP1	853015	21.67
Suburban 2500 New Body Style w/Amber Turn Signals	00-02	BP1	853025	22.01
Tahoe	03-06	BP1	853015	21.67
Tahoe New Body Style w/Amber Turn Signals	00-02	BP1	853025	22.01
Traverse w/Factory 7-Way	09-14	BP1	853026	26.66
CHRYSLER				
Aspen w/Factory Tow Package	07-09	BP2	853020	22.46
DODGE				
Dakota Pickup w/Factory Tow Package (See RAM for 2011 Models)	97-10	BP2	853020	22.46
Durango w/Factory Tow Package	98-09	BP2	853020	22.46
Durango w/Factory Tow Package	11-14	BP2	444207	26.66
Pickup, Ram, Full Size 1500 Only, All Models	95-09	BP2	853020	22.46

- tires & wheels
- axles, hubs & springs
- tongue accessories
- hitches
- electrical
- brake parts
- trailer hardware
- locks & pins
- towing & loading
- tie downs
- tools
- chemicals

TRAILER

BRAKE CONTROL WIRING HARNESSES CONTINUED

- tires & wheels
- axles, hubs & springs
- tongue accessories
- hitches
- electrical
- brake parts
- trailer hardware
- locks & pins
- towing & loading
- tie downs
- tools
- chemicals

TRAILER

MODEL	YEAR	POS	PART #	
DODGE CONTINUED				
Pickup, Ram, Full Size 1500 Only, All Models (See RAM for 2011 & Newer Models)	10	BP1	853021	21.80
Pickup, Ram, Full Size 2500 HD Only, All Models (See RAM for 2011 & Newer Models)	10	BP1	853021	21.80
Pickup, Ram, Full Size 2500 Only, All Models	95-09	BP2	853020	22.46
Pickup, Ram, Full Size 3500 HD Only, All Models (See RAM for 2011 & Newer Models)	10	BP1	853021	21.80
Pickup, Ram, Full Size 3500 Only, All Models	95-09	BP2	853020	22.46
FORD				
Bronco Full Size	94-96	BP3	853035	18.50
E-150 Econoline Van Full Size, All Models	92-08	BP3	853035	18.50
E-150 Econoline Van Full Size, All Models	09-14	BP7	853034	21.72
E-250 Econoline Van Full Size, All Models	92-08	BP3	853035	18.50
E-250 Econoline Van Full Size, All Models	09-14	BP7	853034	21.72
E-350 Econoline Van Full Size, All Models	92-08	BP3	853035	18.50
E-350 Econoline Van Full Size, All Models	09-14	BP7	853034	21.72
E-350 Econoline Van RV Cutaway w/Factory Tow Prep Plug	92-08	BP3	853035	18.50
E-350 Econoline Van RV Cutaway w/Factory Tow Prep Plug	09-11	BP7	853034	21.72
E-450 Econoline Van RV Cutaway w/Factory Tow Prep Plug	92-08	BP3	853035	18.50
E-450 Econoline Van RV Cutaway w/Factory Tow Prep Plug	09-11	BP7	853034	21.72
Excursion	00-05	BP3	853035	18.50
Expedition	97-12	BP3	853035	18.50
Expedition	13-14	BP5	853034	21.72
Explorer w/Factory Tow Package	02-05	BP6	853035	18.50
Explorer w/Factory Tow Package	06-10	BP2	853035	18.50
Explorer w/Factory Tow Package	11-14	BP2	853035	18.50
Explorer Sport Trac w/Factory Tow Package	07-10	BP2	853035	18.50
F-150	94-96	BP3	853035	18.50
F-150 Flareside (New Body Style)	04-08	BP3	853035	18.50
F-150 Flareside (New Body Style)	09-14	BP3	853036	18.17
F-150 Styleside (New Body Style)	04-08	BP3	853035	18.50

MODEL	YEAR	POS	PART #	
FORD CONTINUED				
F-150 Styleside (New Body Style)	09-14	BP3	853036	18.17
F-150 Light Duty Flareside	97-03	BP3	853035	18.50
F-150 Light Duty Styleside	97-03	BP3	853035	18.50
F-150 Light Duty Heritage Flareside Old Body Style	04	BP3	853035	18.50
F-150 Light Duty Heritage Styleside Old Body Style	04	BP3	853035	18.50
F-150 SuperCrew	00-03	BP3	853035	18.50
F-150 SuperCrew New Body Style	04-08	BP3	853035	18.50
F-150 SuperCrew New Body Style, w/5.5 & 6.5 ft. Beds	09-14	BP3	853036	18.17
F-250	94-96	BP3	853035	18.50
F-250 Heavy Duty	97	BP3	853035	18.50
F-250 Light Duty Styleside	97-99	BP3	853035	18.50
F-250 Super Duty	99-04	BP3	853035	18.50
F-250 Super Duty	08-14	BP3	853034	21.72
F-350	94-96	BP3	853035	18.50
F-350 Heavy Duty	97	BP3	853035	18.50
F-350 Super Duty	99-04	BP3	853035	18.50
F-350 Super Duty	08-14	BP3	853034	21.72
F-350 Super Duty Cab & Chassis	08-12	BP3	853034	21.72
F-450 Super Duty	08-14	BP3	853034	21.72
F-450 Super Duty Cab & Chassis	99-04	BP3	853035	18.50
F-450 Super Duty Cab & Chassis	08-12	BP3	853034	21.72
F-550 Super Duty Cab & Chassis	99-04	BP3	853035	18.50
F-550 Super Duty Cab & Chassis	08-12	BP3	853034	21.72
Flex w/Factory Tow Package	09-11	BP2	853035	18.50
Flex w/Factory Tow Package	12-13	BP3	853036	18.17
Windstar w/Factory Tow Package	95-03	BP3	853035	18.50
GMC				
Acadia w/Factory 7-Way	07-14	BP1	853026	26.66
Pickup, Sierra 1500 HD	01-02	BP1	853025	22.01
Pickup, Sierra 1500 HD	03-06	BP1	853015	21.67
Pickup, Sierra 1500 HD Classic Only	07	BP1	853015	21.67

BRAKE CONTROL WIRING HARNESSSES CONTINUED

MODEL	YEAR	POS	PART #	
GMC CONTINUED				
Pickup, Sierra 1500 LD	99-02	BP1	853025	22.01
Pickup, Sierra 1500 LD	03-06	BP1	853015	21.67
Pickup, Sierra 1500 LD 5.8 ft. Bed, 2 & 4 WD (New Body Style)	14	BP2	444206	26.66
Pickup, Sierra 1500 LD 6.6 ft. Bed, 2 & 4 WD (New Body Style)	14	BP2	444206	26.66
Pickup, Sierra 1500 LD Classic Only	07	BP1	853015	21.67
Pickup, Sierra 2500 HD	01-02	BP1	853025	22.01
Pickup, Sierra 2500 HD	03-06	BP1	853015	21.67
Pickup, Sierra 2500 HD Classic Only	07	BP1	853015	21.67
Pickup, Sierra 2500 LD	99-02	BP1	853025	22.01
Pickup, Sierra 2500 LD	03-04	BP1	853015	21.67
Pickup, Sierra 3500 Series	01-02	BP1	853025	22.01
Pickup, Sierra 3500 Series	03-06	BP1	853015	21.67
Pickup, Sierra 3500 Series Classic Only	07	BP1	853015	21.67
Yukon	03-06	BP1	853015	21.67
Yukon New Body Style w/Amber Turn Signals	00-02	BP1	853025	22.01
Yukon Denali	03-06	BP1	853015	21.67
Yukon Denali New Body Style w/Amber Turn Signals	01-02	BP1	853025	22.01
Yukon XL 1500	00-02	BP1	853025	22.01
Yukon XL 1500	03-06	BP1	853015	21.67
Yukon XL 2500	00-02	BP1	853025	22.01
Yukon XL 2500	03-06	BP1	853015	21.67
Yukon XL Denali	01-02	BP1	853025	22.01
Yukon XL Denali	03-06	BP1	853015	21.67
HONDA				
Pilot w/Factory Tow Package	09-14	BP1	853070	15.69
Ridgeline w/Factory Tow Package	06-14	BP1	853070	15.69
HUMMER				
H2	03-07	BP1	853015	21.67
H2 SUT	05-07	BP1	853015	21.67
INFINITI				
QX56	04-14	BP1	853050	22.21
JEEP				
Grand Cherokee w/Factory Tow Package	11-14	BP2	444207	26.66
KIA				
Borrego	09-11	BP4	444208	19.36
LAND ROVER				
LR3	05-09	BP3	853035	18.50
LR4	10-11	BP3	853035	18.50
Range Rover Inc. Sport	05-13	BP3	853035	18.50
Range Rover Evoque	12	BP2	853035	18.50

MODEL	YEAR	POS	PART #	
LEXUS				
GX 460	10-13	BP4	853040	24.44
GX 470	03-09	BP3	853040	24.44
LX 470	03-07	BP3	853040	24.44
LX 570	08-11	BP3	853040	24.44
LX 570	13	BP4	853040	24.44
LINCOLN				
Aviator w/Factory Tow Package	03-05	BP6	853035	18.50
Mark LT	06-08	BP3	853035	18.50
MKT w/Factory Tow Package	10-11	BP1	853035	18.50
MKT w/Factory Tow Package	12	BP1	853036	18.17
Navigator	98-12	BP3	853035	18.50
Navigator	13-14	BP3	853034	21.72
MERCURY				
Mountaineer w/Factory Tow Package	02-05	BP6	853035	18.50
Mountaineer w/Factory Tow Package	06-10	BP2	853035	18.50
NISSAN				
Armada	04-14	BP1	853050	22.21
Frontier Pickup	05-14	BP3	853050	22.21
Pathfinder	05-14	BP3	853050	22.21
Titan Pickup	04-14	BP1	853050	22.21
Xterra w/Factory Tow Package	05-14	BP3	853050	22.21
RAM				
1500 All Models	11-12	BP1	853021	21.80
1500 All Models	13-14	BP3	853023	40.11
		BP9	444209	120.14
		BP8	444210	135.14
2500 HD All Models	11-12	BP1	853021	21.80
2500 HD All Models	13-14	BP3	853023	40.11
		BP8	444210	135.14
		BP9	444209	120.14
3500 HD All Models	11-12	BP1	853021	21.80
3500 HD All Models	13-14	BP3	853023	40.11
		BP9	444209	120.14
		BP8	444210	135.14
Dakota Pickup w/Factory Tow Package	11	BP2	853020	22.46
SATURN				
Outlook w/Factory 7-Way	07-09	BP1	853026	26.66
TOYOTA				
4Runner	03-14	BP4	853040	24.44
LandCruiser	03-11	BP3	853040	24.44
LandCruiser	13-14	BP3	853040	24.44
Sequoia	03-14	BP4	853040	24.44
Tacoma Pickup	07-14	BP4	853040	24.44
Tundra	03-14	BP4	853040	24.44

tires & wheels

axles, hubs & springs

tongue accessories

hitches

electrical

brake parts

trailer hardware

locks & pins

towing & loading

tie downs

tools

chemicals

TRAILER

- tires & wheels
- axles, hubs & springs
- tongue accessories
- hitches
- electrical
- brake parts**
- trailer hardware
- locks & pins
- towing & loading
- tie downs
- tools
- chemicals

- BP1** - Under or behind dash, to the left or right of the emergency brake pedal.
- BP2** - Under or behind dash to the left of the steering column and brake pedal.
- BP3** - Under or behind dash to the right of the steering column and brake pedal.
- BP4** - Kick panel area, on the Driver's side.
- BP5** - Under or behind dash, behind the center console.
- BP6** - Under or behind dash on the passenger side, near glovebox.
- BP7** - Centered behind dash between the steering column and the radio.
- BP8** - Under or behind dash to the right of the steering column and brake pedal. Also includes 7-Way adapter kit located at the rear center behind the bumper. This unit complies with all applicable California Regulations.
- BP9** - Includes 7-Way adapter kit located at the rear center behind the bumper. This unit complies with all applicable California Regulations.

VEHICLE SPECIFIC BRAKE CONTROL WIRING HARNESS POSITION



BRAKE MATE™ KIT

Includes all necessary parts required to completely install all brake controls. No other parts are necessary.

Each BRAKE MATE™ KIT includes:

- Pre-wired 7-way round connector
- Scotch locks (5 pcs.)
- 4-Flat trailer end
- Ring connectors (7 pcs.)
- Heavy-Duty flasher
- Self tapping screws (8 pcs.)
- Heavy-Duty breakers (2 pcs.)
- Tie straps (6 pcs.)

118607 145.30

For simple mounting, choose 7-Way Mounting Box. Part Numbers **DT18156**, **DT18157** or **DT18159** (sold separately). Clamshell packaged.



BRAKE CONTROL INSTALL KITS (WITHOUT 6/7-WAY CONNECTORS)

PART #	DESCRIPTION
820505 68.01	Wiring kit for 1-2 axle brake control systems, includes 25' 12-2 duplex wire, 20 amp circuit breaker and attaching terminals
820506 79.81	Wiring kit for 3-4 axle brake control systems, includes 25' 10-2 duplex wire, 30 amp circuit breaker and attaching terminals



TRAILER

PULSE PREVENTOR

Immunizes against the effects of 4-Way flashers on some brake controls.

444205 32.95





TRAILER ELECTRIC BREAKAWAY SYSTEMS & ACCESSORIES

For use on 1, 2, 3, and 4 axle trailers equipped with electric brakes. These complete systems incorporate the highest quality components in trailer breakaway systems. Meet or exceed Department of Transportation (DOT) specifications regarding trailer breakaway and holding requirements. If a breakaway occurs between your tow vehicle and your trailer, the breakaway systems will automatically apply consistent braking power to your trailer brakes. Quick and easy to install, the systems come with a weather/corrosion resistant, heavy-duty polymer case to protect the battery and charger.

BREAKAWAY SYSTEM - FOR USE ON 1 & 2 AXLE TRAILERS W/ELECTRIC BRAKES

PART #	DESCRIPTION
851026 76.94	Includes 852018 Polymer Battery Case w/A-Frame or Post Mounting Bracket; 852023 Rechargeable Sealed 12v 5 Amp-hr. Lead Acid Battery & Terminals; 852005 Breakaway Switch



BREAKAWAY SYSTEM - FOR USE ON 1, 2, 3 & 4 AXLE TRAILERS W/ELECTRIC BRAKES

PART #	DESCRIPTION
852026 79.43	Includes 852018 Polymer Battery Case w/A-Frame or Post. Lead Acid Battery & Terminals; 852010 Breakaway Switch
8520005 67.78	Includes 852051 Lockable All Polymer Battery Case w/Flat. Lead Acid Battery & Terminals; 852010 Breakaway Switch



BREAKAWAY SYSTEM W/CHARGER - FOR USE ON 1 & 2 AXLE TRAILERS WITH ELECTRIC BRAKES

PART #	DESCRIPTION
851028 87.03	Includes 852018 Polymer Battery Case w/A-Frame or Post Mounting Bracket; 852023 Rechargeable Sealed 12v 5 Amp-hr. Lead Acid Battery & Terminals; 852005 Breakaway Switch;
851024 15.69	DC-to-DC Accelerated Battery Charging Device (ABCD)



BREAKAWAY SYSTEM WITH CHARGER - FOR USE ON 1, 2, 3 & 4 AXLE TRAILERS W/ELECTRIC BRAKES

PART #	DESCRIPTION
852028 100.85	Includes 852018 Polymer Battery Case w/A-Frame or Post Mounting Bracket; 852023 Rechargeable Sealed 12v 5 Amp-hr. Lead Acid Battery & Terminals; 852010 Breakaway Switch
8520015 92.91	Includes 852051 Lockable All Polymer Battery Case w/Flat Lead Acid Battery & Terminals; 852010 Breakaway Switch



PUSH TO TEST BREAKAWAY SYSTEM

Push to test: LEDs indicate fully charged, charging, or recharge • Multi-stage integrated charger provides a fast recharge up to 12.8 volts. Once battery is fully charged, the automatic float mode is designed to provide a continuous charge without overcharging • Activates trailer brakes upon separation of trailer and tow vehicle • For use on 1,2, or 3 axle trailers equipped with electric brakes • Weather/corrosion resistant, heavy-duty polymer case to protect battery and charger • Quick and easy to install • Breakaway switch w/7.5" lead wires • 5 amp/hr battery • Battery box, dimensions - 5" x 4.125" x 4" • Weight - 4.95 lbs. • Note: make sure battery is fully charged prior to towing



PART #	DESCRIPTION
85313 82.77	Push To Test Breakaway System w/Charger

BATTERY CASES

Rust-proof heavy duty polymer cases protect battery and charger from elements and corrosion. Featuring U-shaped clamp style fastener on **852018** to mount over most trailer tongues, **852051** is a lockable case.

PART #	DESCRIPTION
852018 16.70	Battery Case - One-Bolt Installation on Jackpost or A-Frame
852051 13.64	Battery Case - Four-Bolt Installation on Flat Surface



- tires & wheels
- axles, hubs & springs
- tongue accessories
- hitches
- electrical
- brake parts
- trailer hardware
- locks & pins
- towing & loading
- tie downs
- tools
- chemicals

TRAILER



- tires & wheels
- axles, hubs & springs
- tongue accessories
- hitches
- electrical
- brake parts
- trailer hardware
- locks & pins
- towing & loading
- tie downs
- tools
- chemicals

TRAILER

BREAKAWAY SWITCHES

852010



852005

Completely sealed breakaway switches to automatically set trailer brakes in case of accidental trailer breakaway. Required by law in some states. Emergency use only, not to be used to lock brakes when parked or stored. **852010**, and **852005** have reinforced nylon case, weldable metal tab, nylon pin assembly and are rust and corrosion free. **852009** has all metal parts and a brass pin assembly. Clamshell packaged.



852010A



852009

PART #		DESCRIPTION
852010	19.76	Breakaway Switch w/48" wires w/Cable & Nylon Pin Assembly
852005	19.76	Breakaway Switch w/48" wires w/Cable & Nylon Pin Assembly (for use with 1-3 axle trailers)
852009	33.16	Breakaway Switch w/48" wires w/Cable & Brass Pin Assembly
852010A	10.91	48" Replacement Cable & Nylon Pin Assembly (for 852010 Switch)
852009A	18.75	48" Replacement Cable & Brass Pin Assembly (for 852009 Switch)

BATTERY CHARGER

For all 12v battery systems with a 4 amp-hr minimum output. **851024** will return trailer breakaway system batteries to their maximum potential.

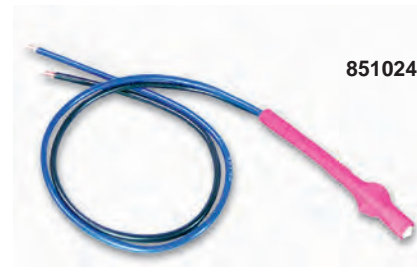

851024

PART #		DESCRIPTION
851024	15.69	DC-to-DC Accelerated Battery Charging Device (ABCD)

BATTERY POST ADAPTER

Battery Post Adapter for General Motors side post batteries. Allows stud for attaching accessories wires. Sold as a pair. Clamshell packaged.



PART #		DESCRIPTION
853194	24.11	Side Post Adapters for General Motors

BATTERY ISOLATORS

Cadmium plated isolator with terminal nuts and lock-washers. 3 terminal isolator for metal frame ground systems, 4 terminal has insulated ground terminal for use with fiberglass or other non-conductive materials. Isolates starting battery, provides secondary battery current for auxiliary power and full time charging of both batteries. Clamshell packaged.

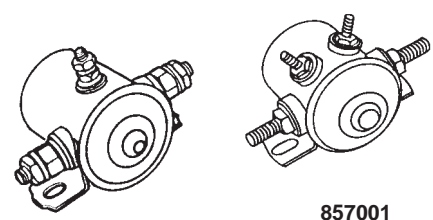

857000

857001

PART #		DESCRIPTION
857000	54.59	Battery Isolator - 3 Terminal
857001	54.59	Battery Isolator - 4 Terminal

CIRCUIT BREAKERS

Used in 6, 12, and 24v DC applications. Automotive, R.V., air conditioners, battery chargers, any application requiring over-current protection. Non-corrosive molded cover eliminates grounding when operating against a fault line. Includes mounting bracket and installed nuts and washers. Clamshell packaged.

PART #		DESCRIPTION
857010	11.31	15 Amp Circuit Breaker
857011	13.97	20 Amp Circuit Breaker
857012	12.20	30 Amp Circuit Breaker
857013	14.42	40 Amp Circuit Breaker
857022	12.54	50 Amp Circuit Breaker



DIELECTRIC GREASE

Using dielectric grease on electrical connectors helps prevent corrosion and increases reliability. Display packaged.

PART #		DESCRIPTION
LB11755	12.95	2 oz. tube dielectric grease



TRAILER BRAKE CONTROLS



AGILITY™

Packed with features to provide the ultimate ease in setting and adjusting for safe, smooth stops.

THE EASIEST TO USE ADVANCED BRAKE CONTROL AVAILABLE



LIFETIME WARRANTY

Innovative Braking Override

Large Digital Readout
Easy to read 5-99% power scale

Digital Sensitivity Adjustment
5 settings for different loads and driving conditions

Digital Power/Gain
Easy to set, easy to adjust stopping force

Towing large trailers hinders your ability to stop quickly. Protect your trailer and vehicle investment with the Agility™ trailer brake control. Most states and provinces have specific laws requiring brakes on trailers depending on weight or stopping distance.

AGILITY™ PLUG-IN SIMPLE!®

The very best!

- Cuts installation time by hours
- Allows for quick removal
- Breaking capacity: Up to 8 trailer brakes



PART #
647294 143.79

INSIGHT™ FLEX-MOUNT™ BRAKE CONTROL

Providing the Ultimate Braking Experience!

The InSIGHT™ brake control with Flex-Mount™ versatility solves the problem of inconvenient mounting while increasing user safety and convenience. This is achieved by bringing the display within the driver's line of sight and the controls within easy reach...**all with no tools required** and Plug-In Simple!® installation.

- Flex-Mount™ Versatility -- Multiple mounting locations in any vehicle
- No Tools Required Installation -- Plug-In Simple!® components
- Increased User Safety -- Keeps eyes on the road and controls within easy reach
- Advanced Proportional Technology -- Mirrors braking action of the towed vehicle for safe, smooth stops
- Digital LED Display -- Intuitive 0-99 scale of power setting
- 7 Sensitivity Settings for Advanced Braking Control
- Short Proof Protection for up to 8 Trailer Brakes
- Electric or Electric/Hydraulic Trailer Brake Compatibility
- Flex-Control™ features a soft glowing light for easy location at night

PART #
620401 191.39



RELIANCE™ PLUG-IN SIMPLE!®

- Fully digital...settings for power level (gain) with built in time-ramp
- Easy to read digital power scale from 5% to 99%
- Innovative vertical slide is easier to see and use than traditional horizontal slides
- Breaking capacity: Up to 4 trailer brakes



PART #
647284 100.95



BRAKE-FORCE™ PLUG-IN SIMPLE!®

- L.E.D. indicator shows trailer connection, braking function and short circuit notification. L.E.D. gradually changes intensities of orange as power setting is increased
- Breaking capacity: Up to 4 trailer brakes



PART #
647225 78.59



- tires & wheels
- axles, hubs & springs
- tongue accessories
- hitches
- electrical
- brake parts
- trailer hardware
- locks & pins
- towing & loading
- tie downs
- tools
- chemicals

TRAILER

FAST SAME DAY SHIPPING

PLUG-IN SIMPLE!® BRAKE CONTROL CONNECTORS



No cutting! no splicing!
Plug-in Simple® connectors
for quick install or removal
of Hopkins® brake controls:

Quick and Easy Installation

Many of today's vehicles come equipped with trailer towing packages that include a quick-connect brake control harness. Simply take our Plug-In Simple brake control connector and attach it to that harness, usually located under the driver's side dashboard. It's that easy.

- 620401 InSIGHT™
- 647294 Agility™
- 647284 Reliance™
- 647235 Impulse™
- 647225 BrakeForce™



(For vehicles equipped
with a factory tow
package.)

APPLICATION	YEAR	PART #	
BUICK			
Enclave	08-15	620404	28.19
CADILLAC			
Escalade	00	647795	21.49
Escalade	02-06	647795	21.49
Escalade / EXT / ESV	07-13	647685	17.69
CHEVROLET			
Avalanche	02-06	647795	21.49
Avalanche (4 pin)(5 pin)(6 pin)	07-13	647685	17.69
Silverado 1500 (New Body)	99-02	647795	21.49
Silverado 1500	03-07	647795	21.49
Silverado 1500 (New Body)	07-13	647685	17.69
Silverado 2500/3500 (New body style)	99-02	647795	21.49
Silverado 2500/3500	03-07	647795	21.49
Silverado 2500/3500 (New body style)	07-13	647685	17.69
Suburban	00-06	647795	21.49
Suburban (4 pin)(5 pin)(6 pin)	07-13	647685	17.69
Tahoe	00-06	647795	21.49
Tahoe (4 pin)(5 pin)(6 pin)	07-13	647685	17.69
Traverse	09-14	620404	28.19
CHRYSLER			
Aspen	07-09	647755	21.49
DODGE			
Dakota	97-11	647755	21.49
Durango	98-09	647755	21.49
Durango (w/ tow pkg)	11-12	620406	28.09
Ram Pickup (all sizes)	95-01	647755	21.49
Ram Pickup (cab & chassis only)	95-02	647755	21.49
Ram Pickup 1500	02-09	647755	21.49
Ram 1500 (w/ tow pkg) see also Ram	10-12	620405	30.69
Ram 1500 (w/ tow pkg) see also Ram	13-14	620407	29.19
Ram Pickup 2500/3500	02-09	647755	21.49
Ram Pickup 2500/3500 (w/ tow pkg) see also Ram	10-12	620405	30.69
FORD			
Bronco	94-96	647715	16.99
E-350 RV, E-450 RV	09-11	620403	28.29
Econoline Van	94-08	647715	16.99
Econoline Van	09-13	620403	28.29
Excursion	00-05	647715	16.99
Expedition (w/o tow)	97-03	647715	16.99

APPLICATION	YEAR	PART #	
FORD CONTINUED			
Expedition	97-03	647715	16.99
Expedition (w/ factory 4 flat)	00-02	647715	16.99
Expedition (w/ factory 7 blade)	99-12	647715	16.99
Expedition (w/ factory 7 blade)	13	620403	28.29
Explorer	00-13	647715	16.99
F-150, 250, 350	94-96	647715	16.99
F-150	97-08	647715	16.99
F-150 (w/ tow pkg)	09-14	620402	28.19
F-250 Light Duty (mfg. 1/96 - 10/96)	97	647715	16.99
F-250 Light Duty (mfg. 11/96 - 2001)	97-01	647715	16.99
F-250 Heavy Duty, F-350	94-97	647715	16.99
F-250 Heavy Duty, F-350	99-04	647715	16.99
F-250 Heavy Duty, F-350	05-07	647735	21.49
F-250, 350 All	08-15	620403	28.29
F-450 Heavy Duty, F-550	05-07	647735	21.49
F-450 Heavy Duty, F-550	08-15	620403	28.29
F-53 Motor Home Chasis	00-14	647715	16.99
Flex	09-11	647715	16.99
Flex	12-14	620402	28.19
Windstar	95-03	647715	16.99
GMC			
Acadia (w/o tow pkg)	07-14	620404	28.19
Denali	99-06	647795	21.49
Denali	07-13	647685	17.69
Sierra 1500 (New body style)	99-07	647795	21.49
Sierra 1500 (New body style)	07-13	647685	17.69
Sierra 2500/3500	03-07	647795	21.49
Sierra 2500/3500 (New body style)	07-13	647685	17.69
Yukon	00-06	647795	21.49
HONDA			
Pilot	09-15	647935	21.39
Ridgeline	06-12	647935	21.39
HUMMER			
H2	03-07	647795	21.49
H2	08-09	647685	17.69
INFINITI			
QX56 (w/ tow pkg), QX80	04-15	647635	21.19
JEEP			
Grand Cherokee (w/ tow pkg)	11-15	620406	28.09

TRAILER

PLUG-IN SIMPLE!® BRAKE CONTROL CONNECTORS continued

APPLICATION	YEAR	PART #	
LAND ROVER			
LR3	05-10	647715	16.99
LR4	10-11	647715	16.99
Range Rover	05-13	647715	16.99
LEXUS			
GX460	10-13	647815	21.49
GX470	03-10	647815	21.49
LX 570	08-13	647815	21.49
LINCOLN			
Aviator (w/ factory 4 flat)	03-05	647715	16.99
Aviator (w/ factory 7 blade)	03-05	647715	16.99
Mark LT	07-08	647715	16.99
MKT	10-11	647715	16.99
MKT	12-13	620402	28.19
Navigator	98-12	647715	16.99
Navigator	13-14	620403	28.29
MERCURY			
Mountaineer	02-10	647715	16.99

APPLICATION	YEAR	PART #	
NISSAN			
Armada	04-13	647635	21.19
Frontier Pickup	04-13	647635	21.19
NV Van	14	647635	21.19
Pathfinder	04-13	647635	21.19
Titan	04-13	647635	21.19
Xterra	04-13	647635	21.19
RAM			
Ram 1500 (w/ tow pkg)	10-12	620405	30.69
Ram 1500 (w/ tow pkg)	13-14	620407	29.19
Ram Pickup 2500/3500 (w/ tow pkg)	10-12	620405	30.69
SATURN			
Outlook	07-10	620404	28.19
TOYOTA			
Land Cruiser	03-10	647815	21.49
4-Runner	03-11	647815	21.49
Sequoia (w/ tow pkg) (MT)	03-13	647815	21.49
Tacoma	05-13	647815	21.49
Tundra	03-12	647815	21.49

QUICK REFERENCE BRAKE CONTROL WIRING GUIDE

NOTE: Locate wires on vehicle by function only. Not all vehicles are listed below. Refer to product instructions.

BRAKE CONTROL	1994-07 FORD	1999-06 CHEV/GM	2007-08 CHEV/GM	1997-02 DODGE	2003-07 DODGE	NISSAN	TOYOTA
BLUE (Electric Brake)	BLUE	DARK BLUE	BLUE	BLUE	BLUE	BROWN / WHITE	RED
BLACK (Battery)	RED	RED	RED / BLACK	RED	WHITE / RED	RED	BLACK / RED
RED (Brake Switch)	GREEN	LT. BLUE	LT. BLUE / WHITE	WHITE	BLUE / WHITE	RED / GREEN	GREEN / WHITE
WHITE (Ground)	WHITE	BLACK	WHITE	BLACK	GREEN / BLACK	BLACK	BROWN

SECOND VEHICLE MOUNTING KIT

For Impulse™ and BrakeForce™ brake controls

PART #
647685 17.69



1-207-942-6769
FAX: 1-207-941-0247

AUTOMATIC DISTRIBUTORS

24/7 On-line Order Management!

- Import Orders
- Order Tracker
- Order Pad
- Line Item Add
- Quick Item Check
- Review Orders
- Review Tracking Numbers
- Interactive Catalogs and more!

VISIT US ON-LINE AT
www.autodist.com

tires & wheels
axles, hubs & springs
tongue accessories
hitches
electrical
brake parts
trailer hardware
locks & pins
towing & loading
tie downs
tools
chemicals

TRAILER

BREAK-AWAY KITS



BUILT-IN BATTERY METER WITH LED TEST LIGHTS

- Activates trailer brakes upon separation from tow vehicle
- Convenient test button verifies battery charge
- LEDs indicate: fully charged, re-charge, or charging
- Built-in battery charger
- Charges battery while plugged into vehicle
- 1 to 2 axle capacity
- 5 amp hour battery
- Trailer break-away kits are legally required in most states and provinces

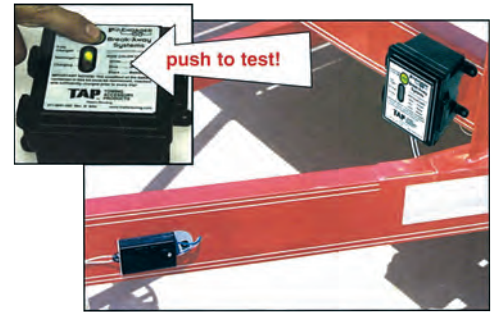

ENGAGER™ BREAK-AWAY KIT STANDARD SIDE MOUNT - NO SCREWS

- 24" Wires, includes battery charger

PART #
620408 58.95



WELDABLE MOUNTING PLATE

- For Engager™ Side-Mount (3 hole) Break-Away Kits
- Eliminates the need to drill holes in the trailer frame

PART #
620410 11.89



- For Engager™ Flip-Top (4-6 hole) Break-Away Kits
- Eliminates the need to drill holes in the trailer frame

PART #
620411 11.79

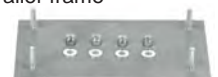

ENGAGER™ SM BREAK-AWAY KIT WITH BATTERY METER

Complete system includes charger, switch, cable / pin, and mounting screws

PART #
620099 73.95



ENGAGER™ FT BREAK-AWAY KIT WITH BATTERY METER

Complete system includes charger, switch, cable / pin, and mounting screws

PART #
620400 73.95



L.E.D BREAKAWAY SWITCH

- Safety feature
- Indicates 12-volt power is being transferred to the trailer brakes
- Weatherproof design

L.E.D. BREAK-AWAY SWITCH
7" Length

PART #
620050 19.59



L.E.D. BREAK-AWAY SWITCH
44" Length

PART #
620060 19.49

REPLACEMENT CABLE & PIN

For use only with:
L.E.D. break-away
switches 620050 and
620060

PART #
620052 7.79



BREAKAWAY SWITCH



L.E.D. BREAK-AWAY SWITCH
7" Length

PART #
620005 15.79

L.E.D. BREAK-AWAY SWITCH
44" Length

PART #
620014 15.59

REPLACEMENT BREAK-AWAY CABLE & PIN

For use only with:
Standard break-away
switches 620005, 620014

PART #
620009 7.89



BREAK-AWAY KIT

WITH CHARGER, SWITCH AND HARDWARE KIT

Rustproof, plastic case protects battery and charger. For use on single and tandem axle trailers with electric brakes.

PART #
620001 63.95



BATTERY CHARGER

PART #
620007 9.79



BOX & HARDWARE

PART #
620006 22.89



TRAILER



MAGNET KITS



	<p>855114 98.81</p> <p>BLACK WIRES Length 3-1/8 Width 2 Thickness 15/16 Fits or Replaces Dexter 12 x 2 - 7K Axles</p>	<p>855118 48.86</p> <p>YELLOW WIRES Length 3-1/8 Width 2 Thickness 15/16 Fits or Replaces Dexter 10 x 1-1/2 (After Mid 1988)</p>																								
<p>855106 87.62</p> <p>GREEN WIRES Length 3-1/8 Width 2 Thickness 15/16 Fits or Replaces Dexter 10 x 2-1/4 Hayes 10 x 2-1/4 (After Mid 1987) Hayes 10 x 1-5/8 (After Mid to 1987) Trailer Pac 102 Tow Craft 1103-100-017</p>	<p>855109 90.90</p> <p>WHITE WIRES Length 3-1/8 Width 2 Thickness 15-16 Fits or Replaces Dexter 12 x 2 Hayes 12 x 2 (After late 1987) Trailer Pac 103 Tow Craft 1103-100-018</p>	<p>856106 81.90</p> <p>LIGHT GREEN WIRES Length 3-1/8 Width 2 Thickness 15/16 Fits or Replaces AL-KO Kober 10 x 2-1/4</p>																								
<p>BEARING & CUP SETS</p> <p>• Sold each CUP/CONE</p> <table border="1"> <thead> <tr> <th></th> <th>PART #</th> <th></th> </tr> </thead> <tbody> <tr> <td>L15245/L15123</td> <td>LM15123CC</td> <td>8.95</td> </tr> <tr> <td>L25520/L25580</td> <td>LM25580CC</td> <td>12.95</td> </tr> <tr> <td>L44610/L44643</td> <td>LM44643CC</td> <td>5.95</td> </tr> <tr> <td>LM48510/LM48548</td> <td>LM48548CC</td> <td>9.95</td> </tr> <tr> <td>LM67010/LM67048</td> <td>LM67048CC</td> <td>6.95</td> </tr> <tr> <td>L68111/L68149</td> <td>LM68149CC</td> <td>6.95</td> </tr> <tr> <td>L11910/L11949</td> <td>LM6CC</td> <td>6.95</td> </tr> </tbody> </table>		PART #		L15245/L15123	LM15123CC	8.95	L25520/L25580	LM25580CC	12.95	L44610/L44643	LM44643CC	5.95	LM48510/LM48548	LM48548CC	9.95	LM67010/LM67048	LM67048CC	6.95	L68111/L68149	LM68149CC	6.95	L11910/L11949	LM6CC	6.95	<p>855113 66.42</p> <p>WHITE WIRES Length 2 1/16 Width 1 15/16 Thickness 3/4 Fits or Replaces Dexter 12 x 1-1/2 (Prior to Mid 1988) Dexter 7 x 1-1/4 (After April 1990)</p>	<p>855109 90.90</p> <p>WHITE WIRES Length 3-1/8 Width 2 Thickness 15/16 Fits or Replaces AL-KO Kober 12 x 2 6K & 7K</p>
	PART #																									
L15245/L15123	LM15123CC	8.95																								
L25520/L25580	LM25580CC	12.95																								
L44610/L44643	LM44643CC	5.95																								
LM48510/LM48548	LM48548CC	9.95																								
LM67010/LM67048	LM67048CC	6.95																								
L68111/L68149	LM68149CC	6.95																								
L11910/L11949	LM6CC	6.95																								

- tires & wheels
- axles, hubs & springs
- tongue accessories
- hitches
- electrical
- brake parts
- trailer hardware
- locks & pins
- towing & loading
- tie downs
- tools
- chemicals

REPLACEMENT PARTS THAT DO NOT APPEAR IN EXPLODED VIEW

<p>MAGNET RETAINING RING</p> <p>10 x 1-5/8 Hayes 10 x 2-1/4 Hayes (Old Style) 12 x 2 Hayes (Old Style)</p> <p>855120 12.22</p>	<p>ADJUSTING SLOT PLUG (CAPS) ALL SYSTEMS</p> <p>855410 4.50</p>
--	--

MAGNET IDENTIFICATION MAGNETS CAN BE IDENTIFIED BY THE COLOR OF THE WIRE USED

Dexter 7" x 1-1/4"	The magnets are round. Prior to April 1990 they had yellow wires, after 1990 the magnet has white wires. Replacement of magnets will need to be done in pairs and updated to the new magnet along with the lever. The early levers are weak and will bend and hang up as they wear.
Dexter 10" x 1-1/2"	The magnet wires for the early model round magnets are white and the late model oval magnets are yellow.
Hayes 10" x 1-5/8"	The magnet wires for the early model round magnets are red and the late model oval magnets are green.
AL-KO 10" x 2-1/4"	It will have light green wires.
Hayes 10" x 2-1/4"	The early model round will have red wires and the late model will have oval green wires.
Dexter 10" x 2-1/4"	It uses green wires.
Fayette 10" x 2-1/4"	The round magnets will have white wires (obsolete).
AL-KO 12" x 2"	It will have white wires.
Hayes 12" x 2"	The early model round magnet will have red wires, the late model will be an oval magnet with white wires.
Dexter 12" x 2"	It will have white wires.
Dexter Centerline 12" x 2"	The 4.5K axles will have red orange wires, the 6/7K axles will have red wires (obsolete for both sizes).

TRAILER

BRAKE PARTS

ALKO 10" x 2-1/4"

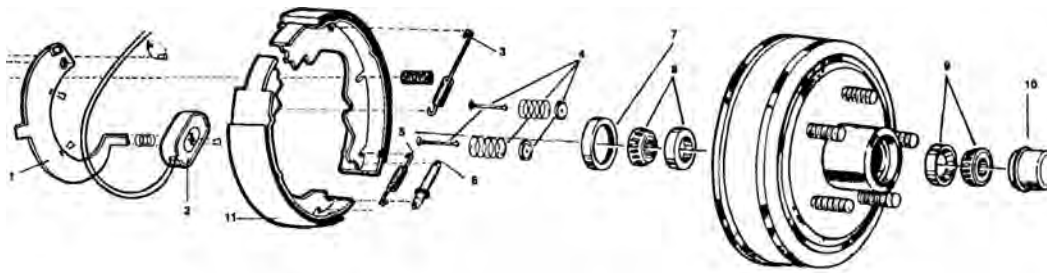

PART #	REF #	DESCRIPTION
856205	13.50	1 Actuating Lever - R.H.
856206	20.41	1 Actuating Lever - L.H.
856106	81.90	2 Magnet Kit
855304	9.11	3 Return Spring Set (Axle Set)
855353	17.77	4 Hold Down Kit (Axle Set)
855404	19.05	5,6 Adjusting Screw Kit (Spring & Screw Assembly)
GS545138	1.95	7 Grease Seal (each)
GCP10	1.50	10 Grease Cap (each)
LM68149CC	6.95	8 Bearing Set - Inner LM68111, LM68149
TBK9	12.95	7,8,9,10 Bearing/Seal Kit
856004	69.50	11 Shoe and Lining Kit

ALKO 12" x 2"

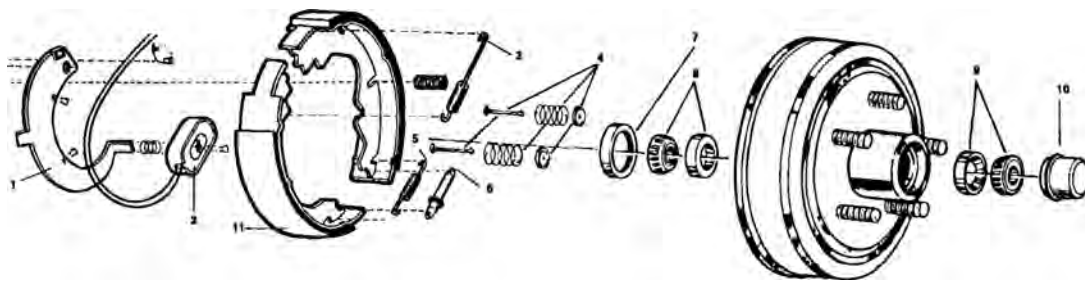

PART #	REF #	DESCRIPTION
856211	20.83	1 Actuating Lever - R.H.
856109	84.96	2 Magnet Kit
855307	13.46	3 Single Refractor
855353	17.77	4 Hold Down Kit (Axle Set)
855404	19.05	5,6 Adjusting Screw Kit (Spring & Screw Assembly)
856713	170.09	Complete Assembly - L.H.
856714	170.09	Complete Assembly - R.H.
855605	1.95	7 Grease Seal (each)
856658	14.57	10 Grease Cap for LM14125CC (each)
855652	8.63	10 Grease Cap for LM15123CC
LM25580CC	12.95	8 Bearing Set - Inner
LM15123CC	8.95	9 Bearing Set - Outer Small Bore LM15123, LM15245
856005	100.55	11 Shoe and Lining Kit

- tires & wheels
- axles, hubs & springs
- tongue accessories
- hitches
- electrical
- brake parts
- trailer hardware
- locks & pins
- towing & loading
- tie downs
- tools
- chemicals

TRAILER

DEXTER 7" x 1-1/4"

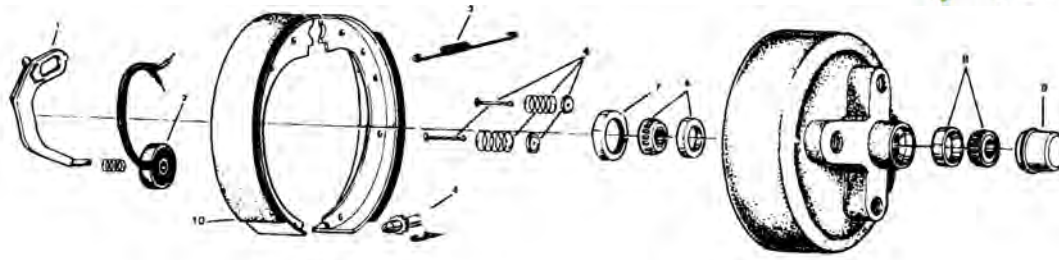

PART #	REF #	DESCRIPTION
855113***	66.42	2 Magnet Kit
855320	40.49	3 Return Spring
SOLD ONLY AS A KIT	4	Hold Down Clips
	5	Adjusting Screw Spring
	6	Adjusting Screw Assembly
GS203025	0.95	7 Seal - BTR (each)
GCP10	1.50	9 Grease Cap (each)
TBK9	12.95	7,8,9 Bearing/Seal Kit
855002	59.51	10 Shoe and Lining Kit

***After 4-90 to accommodate lever revision

DEXTER 10" x 1-1/2"

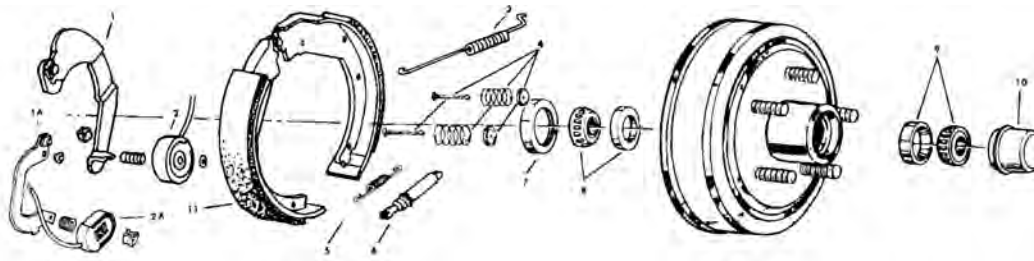

PART #	REF #	DESCRIPTION
855231**	13.50	1A Actuating Lever - R.H.
855232**	13.50	1A Actuating Lever - L.H.
855113*	66.42	2 Magnet Kit
855118*	48.86	2A Magnet Kit
855306	8.30	3 Return Spring Set (Axle Set)
855404	19.05	5,6 Adjusting Screw Kit (Spring & Screw Assembly)
855607	10.56	7 Grease Seal (each)
GCP10	1.50	10 Grease Cap (each)
LM67048CC	6.95	8 Bearing Set - Inner LM67048, LM67010
855009	85.97	11 Shoe and Lining Kit (Axle Set)

* Prior to Mid 1988 ** After Mid 1988

tires & wheels

axles, hubs & springs

tongue accessories

hitches

electrical

brake parts

trailer hardware

locks & pins

towing & loading

tie downs

tools

chemicals

TRAILER

- tires & wheels
- axles, hubs & springs
- tongue accessories
- hitches
- electrical
- brake parts
- trailer hardware
- locks & pins
- towing & loading
- tie downs
- tools
- chemicals

TRAILER

DEXTER 10" x 2-1/4"

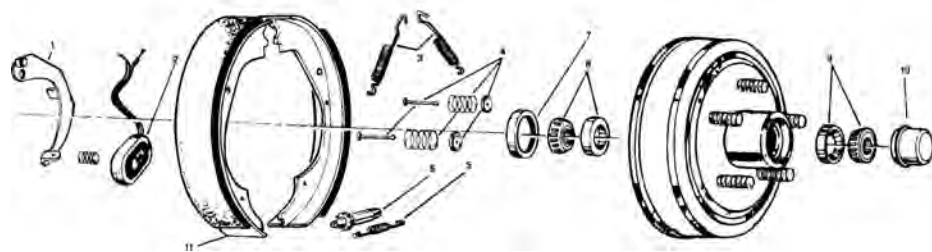

PART #		REF #	DESCRIPTION
855106	87.62	2	Magnet Kit
855305	12.56	3	Return Spring Set (Axle Set)
855353	17.77	4	Hold Down Kit (Axle Set)
855404	19.05	5,6	Adjusting Screw Kit (Spring & Screw Assembly)
GS545138	1.95	7	Grease Seal (each)
GCP10	1.50	10	Grease Cap (each)
LM48548CC	9.95	8	Bearing Set - Inner (Prior to Dec. 1983) LM48510, LM48548
LM68149CC	6.95	9	Bearing Set - Outer (After Dec. 1983) LM68111, LM68149
855003	71.19	11	Shoe and Lining Kit

DEXTER 12" x 2"

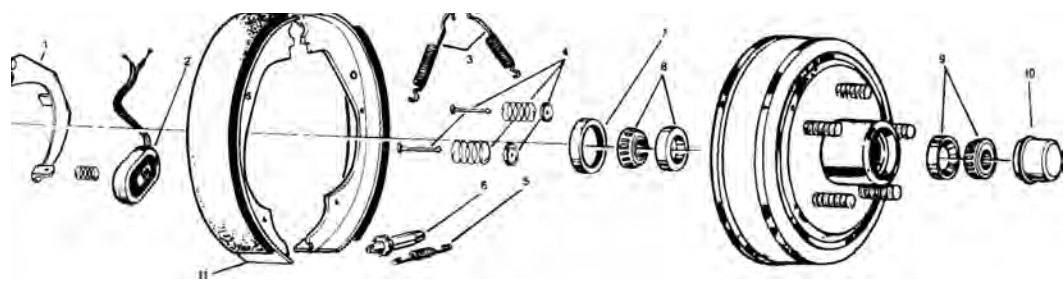

PART #		REF #	DESCRIPTION
855109	90.90	2	Magnet Kit
See 3A/3B		3	Return Spring Set (Axle Set)
855307	13.46	3A	Single Retractor
855305	12.56	3B	Dual Retractor
855353*	17.77	4	Hold Down Kit (Axle Kit)
855404	19.05	5,6	Adjusting Screw Kit (Spring & Screw Assembly)
855606	1.95	7	Grease Seal (each)
855652	8.63	10	Grease Cap (each)
LM25580CC	12.95	8	Bearing Set - Inner LM25520, LM25580
LM67048CC	6.95	9	Bearing Set - Outer LM67048, LM67010
855000D	84.51	11	Shoe and Lining Kit

* Replacement Kit Uses Coil Springs

DEXTER 12" x 2" 7K

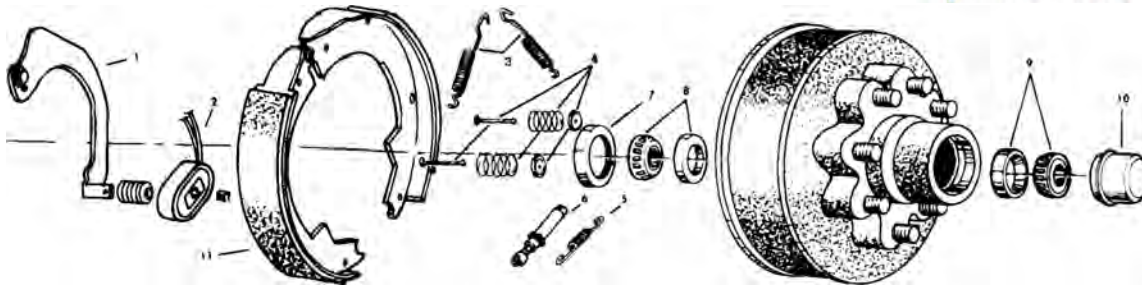

PART #	REF #	DESCRIPTION
855114	98.81	2 Magnet Kit
855305	12.56	3 Return Spring Set (Axle Set)
855353	17.77	4 Hold Down Kit (Axle Set)
855404	19.05	5,6 Adjusting Screw Kit (Spring & Screw Assembly)
855606	1.95	7 Grease Seal (each)
855652	8.63	10 Grease Cap (each)
LM25580CC	12.95	8 Bearing Set - Inner LM25520, LM25580
LM15123CC	8.95	9 Bearing Set - Outer (UTG Hub) LM15123, LM15245 (Small Bore)
855010	147.51	11 Shoe and Lining Kit

HAYES 10" x 1-5/8"

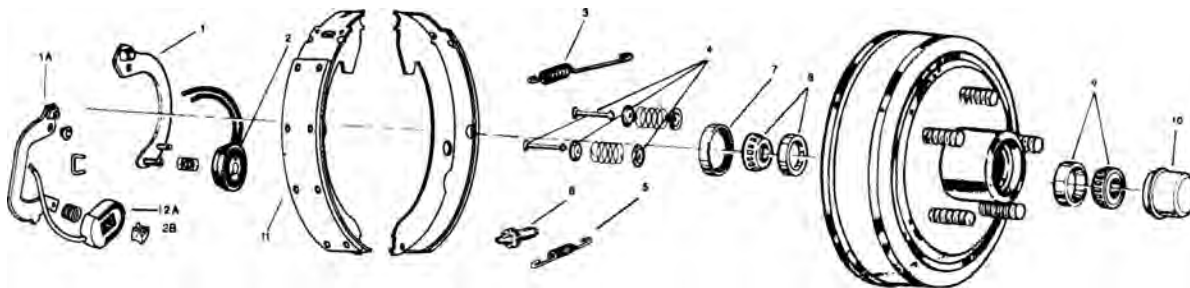

PART #	REF #	DESCRIPTION
855106**	87.62	2A Magnet Kit (6K & 7K Axles)
-----		2B Magnet Kit - White Wire
855304	9.11	3 Return Spring Set (Axle Set)
855404	19.05	5,6 Adjusting Screw Kit (Spring & Screw Assembly)
GS545138	1.95	7 Seal (Axle Set) (each)
GCP10	1.50	10 Grease Cap (Axle Set) (each)
LM67048CC	6.95	8 Bearing Set - Inner LM67048, LM67010

* Replace Lever and Use 5106 Magnet ** After Mid 1987

FAST SAME DAY SHIPPING

TRAILER CATALOG 153

- tires & wheels
- axles, hubs & springs
- tongue accessories
- hitches
- electrical
- brake parts**
- trailer hardware
- locks & pins
- towing & loading
- tie downs
- tools
- chemicals

TRAILER



HAYES 10" x 2-1/4"

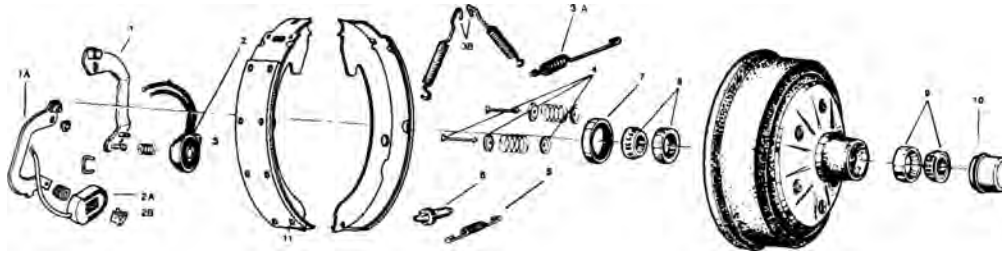

PART #	REF #	DESCRIPTION
855205**	13.50	1A Actuating Lever - R.H.
855206**	13.50	1A Actuating Lever - L.H.
855106**	87.62	2A Magnet Kit
-----		2B Magnet Kit - White Wire Late 1994
855304	9.11	3A Single Retractor
855305****	12.56	3B Dual Retractor
855353	17.77	4 Hold Down Kit (Axle Set)
855404	19.05	5,6 Adjusting Screw Kit (Spring & Screw Assembly)
GS545138	1.95	7 Grease Seal (each)
GCP10	1.50	10 Grease Cap (each)
LM68149CC***	6.95	8 Bearing Set - Inner LM68111, LM68149
856004	69.50	11 Shoe and Lining Kit

* Prior to Mid 1987 ** After Mid 1987 *** After 1972 **** Prior to May 1977

HAYES 12" x 2"

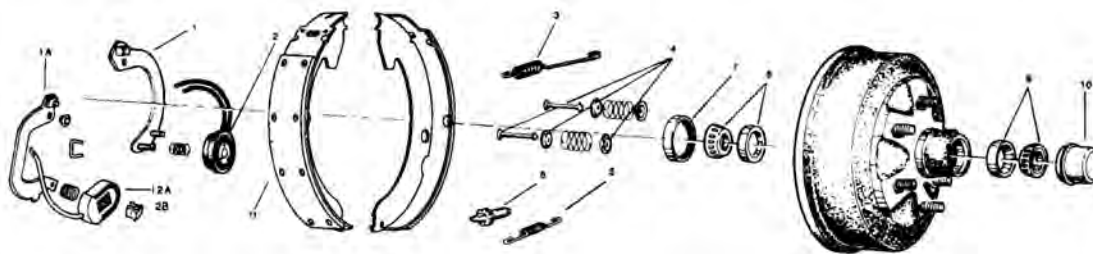

PART #	REF #	DESCRIPTION
855211**	20.83	1A Actuating Lever - R.H.
855212**	20.83	1A Actuating Lever - L.H.
855109*	90.90	2A Magnet Kit
-----		2B Magnet Kit - White Wire Late 1994
855307	13.46	3 Return Spring et (Axle Set)
855353	17.77	4 Hold Down Kit (Axle Kit)
855404	19.05	5,6 Adjusting Screw Kit (Spring & Screw Assembly)
855605	1.95	7 Grease Seal (each)
855652	8.63	10 Grease Cap (each)
LM25580CC	12.95	8 Bearing Set - Inner LM25520, LM25580
LM67048CC	6.95	9 Bearing Set - Outer LM67048, LM67010
855000H	39.50	11 Shoe and Lining Kit (Axle Set)

TRAILER

tires & wheels

axles, hubs & springs

tongue accessories

hitches

electrical

brake parts

trailer hardware

locks & pins

towing & loading

tie downs

tools

chemicals

HAYES 12" X 2" CENTERLINE

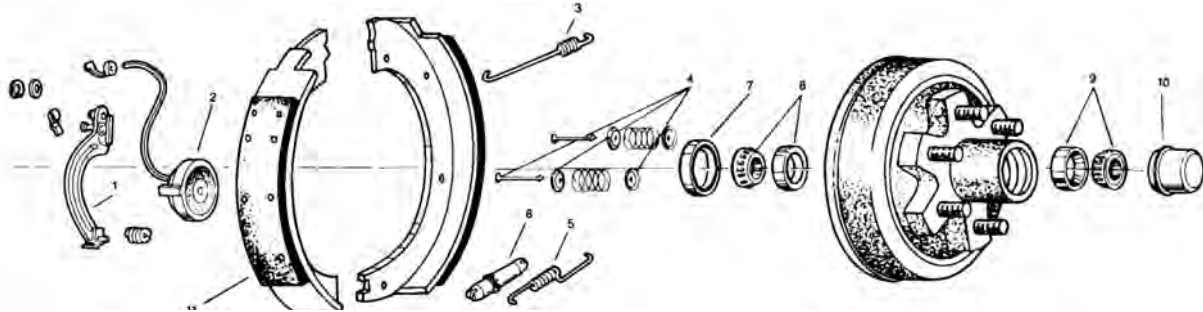

PART #		#	DESCRIPTION
855353	17.77	4	Hold Down Kit (Axle Set)
855404	19.05	5,6	Adjusting Screw Kit (Spring & Screw Assembly)
855605	1.95	7	Grease Seal (each)
855652	8.63	10	Grease Cap (each)
LM25580CC	12.95	8	Bearing Set - Inner LM25520, LM25580
LM67048CC	6.95	9	Bearing Set - Outer LM67048, LM67010

FAYETTE 10" x 2-1/4"

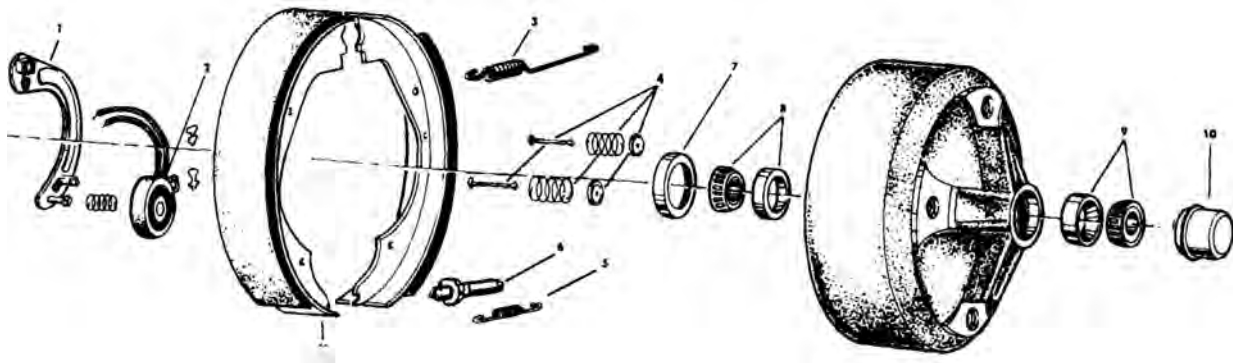

PART #		REF #	DESCRIPTION
855304	9.11	3	Return Spring et (Axle Set)
855353*	17.77	4	Hold Down Kit (Axle Kit)
855404	19.05	5,6	Adjusting Screw Kit (Spring & Screw Assembly)
GS545138	1.95	7	Grease Seal (each)
GCP10	1.50	10	Grease Cap (each)
LM68149CC	6.95	8	Bearing Set - Inner LM68111, LM68149
TBK9	12.95	7,8,9,10	Bearing/Seal Kit

* Contained in Hardware Kit (Axle Kit)

tires & wheels

axles, hubs & springs

tongue accessories

hitches

electrical

brake parts

trailer hardware

locks & pins

towing & loading

tie downs

tools

chemicals

TRAILER



FAYETTE 12" x 2"

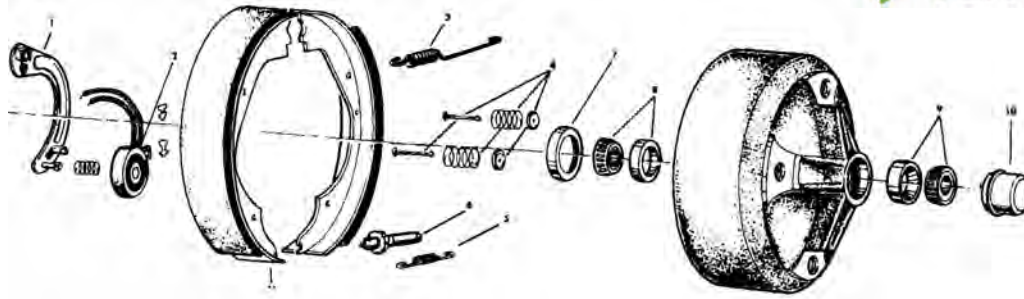

PART #		REF #	DESCRIPTION
855307	13.46	3	Return Spring Set (Axle Set)
855353*	17.77	4	Hold Down Kit (Axle Set)
855404	19.05	5,6	Adjusting Screw Kit (Spring & Screw Assembly)
855307	13.46	3	Return Spring Set (Axle Set)
855353*	17.77	4	Hold Down Kit (Axle Set)
855404	19.05	5,6	Adjusting Screw Kit (Spring & Screw Assembly)

- Replacement Kit Uses Coil Springs
- Bonded Shoes

- tires & wheels
- axles, hubs & springs
- tongue accessories
- hitches
- electrical
- brake parts
- trailer hardware
- locks & pins
- towing & loading
- tie downs
- tools
- chemicals

TRAILER

G5 STAINLESS STEEL DISC BRAKE

- 3500# Axle 5 Lug 9.6" Rotor, For 13", 14" or 15" Wheels, Replaces 10" Drum Brakes.
- All Aluminum Caliper: 380 series Aluminum w/E-Coat, sheds heat five times faster than cast iron
- 304 Stainless Steel Rotor with Venting Holes, Diameter: 9.6" x .3125"
- Pre-greased hub includes bearings & seal. Uses lithium based or lithium compatible.
- Hub Specs: 1,750# cap, 5 on 4.5" Hub Finish - GalvX Bearing Size: Outer 1 1/16" (L44649) Inner 1 3/8" (L68149) includes mounting bracket and lug nuts



276003 333.95

10" G4.5 DISC BRAKE UPGRADE KIT

Single piston aluminum caliper, patented bimetal aluminum/stainless piston, oil impregnated bronze bushings ceramic pads with stainless steel backing plates stainless steel slider pins, GalvX coated hub and galvanized mounting bracket.

- Precision bearings, seals and grease factory installed
- Factory pre-installed stainless steel slider pins
- Each kit is for one wheel, includes mounting bracket
- Stainless steel rotor with venting holes for faster cooling
- G4.5 upgrade kits replaces G4 caliper with G5 caliper with lifetime pads
- Includes: Caliper, GalvX mounting bracket and ceramic pads



276004 230.95

REPLACEMENT PARTS



FREE BACKING SOLENOID

LR81103 76.95



FLEXIBLE BRAKE LINE KIT

- Rated at 3000 PSI
- 24" long
- 2 hoses with brass filling

LR81099 69.95

BRAKE COMPONENT PARTS

ELECTRIC BRAKE ASSEMBLIES

- Assemblies include backing plate shoe and lining, magnets, & actuating lever
- Adjusting screw and spring hardware units come completely assembled

855714	161.99	12" x 2"	R.H. Hayes Assembly
856713	170.09	12" x 2"	L.H. ALKO Assembly
856714	170.09	12" x 2"	ALKO Assembly



ELECTRIC BRAKE ASSEMBLIES

- Replaces Dexter Electric Trailer Brake Assemblies
- Units are assembled
- Assemblies include: Backing Plate, Shoe and Linings, Magnets, Actuating Lever, Adjusting Screw and Spring Hardware.

444211	88.55	10 x 2 1/4 Right Hand Brake Assembly
444212	103.14	10 x 2 1/4 Left Hand Brake Assembly
444214	120.92	12 x 2 Left Hand Brake Assembly



BRAKE ASSEMBLY MOUNTING BOLTS

855720	9.79	3/8" Brake Assembly Mounting Bolt • Set of 5 • Used on 5 bolt mounting patterns
855721	9.91	7/16" Brake Assembly Mounting Bolt • Set of 4 • Used on 4 bolt mounting patterns



UNI-SERVO HYDRAULIC BRAKE ASSEMBLIES

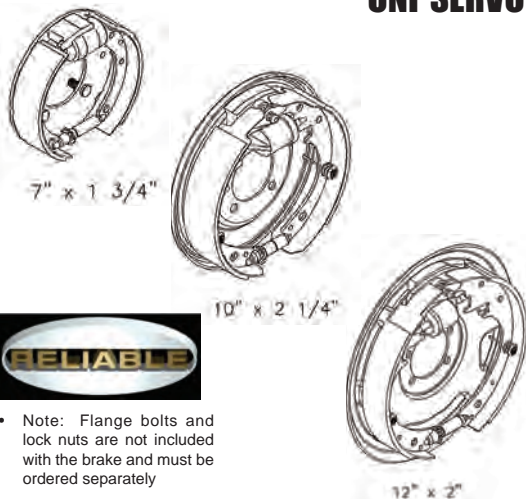

PART #	PART #	SIZE	CAPACITY
LEFT SIDE	RIGHT SIDE		
RL0700 84.75	RL0702 89.95	7" x 1-3/4"	1250#
RL1000 99.95	RL1002 107.95	10" x 2-1/4"	1850#
RL1200 125.17	RL1202 102.80	12" x 2"	2600#

FLANGE BOLTS (sold each)	SIZE	ZINC PLATED FLANGE LOCK NUTS (sold each)	
RL437 (4 per brake)	0.70 7/16-20	RL439 (4 per brake)	0.70
RL375 (5 per brake)	0.55 3/8-16	RL379 (5 per brake)	0.25

- Note: Flange bolts and lock nuts are not included with the brake and must be ordered separately

FAST SAME DAY SHIPPING

- tires & wheels
- axles, hubs & springs
- tongue accessories
- hitches
- electrical
- brake parts
- trailer hardware
- locks & pins
- towing & loading
- tie downs
- tools
- chemicals

TRAILER

- tires & wheels
- axles, hubs & springs
- tongue accessories
- hitches
- electrical
- brake parts
- trailer hardware
- locks & pins
- towing & loading
- tie downs
- tools
- chemicals

BRAKE COMPONENT PARTS

BRAKE DRUM

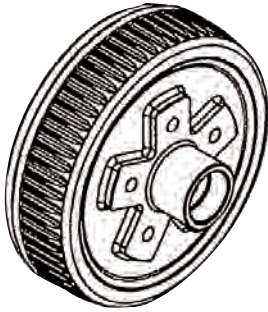

- 5 stud on 4-1/2"
- E-coated
- Use with hub HSH545
- Recommended for use with 13", 14", and 15" wheels
- 10" drum diameter
- Inner bearing LM68149 (1-3/8"), outer bearing LM44649 (1-1/16")

PART #		DESCRIPTION
RL51009	148.45	Brake Drum



DISC BRAKE ROTOR

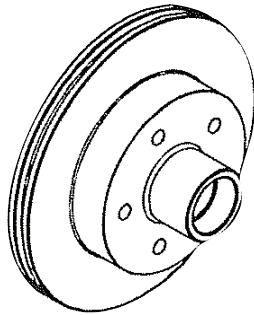

- 5 stud on 4-1/2"
- E-coated

PART #		DESCRIPTION
RL91001	67.90	Brake Rotor
RL91100	129.45	L.H. Disc Brake Caliper Assembly
RL91102	129.45	R.H. Disc Brake Caliper Assembly



DRUM HUBS



- Hubs are designed to work with hydraulic or electric drum brakes
- Painted brake drum hubs for greater corrosion resistance
- Drum hub only with cups and studs

PART #		HUB	CIRCLE
LR81004	124.95	5 Stud	10"
LR81003	141.95	6 Stud	12"



TRAILER BRAKE ADJUSTMENT**

Brakes should be adjusted after the first 200 miles of operation when the brake shoes and drums have "seated" and at 3000 mile intervals, or as use and performance requires. The brakes should be adjusted in the following manner:

1. Jack up trailer and secure on adequate capacity jack stands. Follow trailer manufacturers recommendations for lifting and supporting the unit. Check that the wheel and drum rotate freely.

WARNING: Do not lift or support trailer on any part of the axle or the suspension system.

2. Remove the adjusting hole cover from the adjusting slot on the bottom of the brake backing plate.
3. With a screwdriver or standard adjusting tool, rotate the starwheel of the adjuster assembly to expand the brake shoes. Adjust the brake shoes out until the pressure of the linings against the drum makes the wheel very difficult to turn.

Note: With drop spindle axles, a modified adjusting tool with about an 80 degree angle should be used.

4. Then rotate the starwheel in the opposite direction until the wheel turns freely with a slight lining drag.
5. Replace the adjusting hole cover and lower the wheel to the ground.
6. Repeat the above procedure on all brakes.

WARNING: Never crawl under your trailer unless it is resting on properly placed jack stands.

Follow the trailer manufacturers recommendations for lifting and supporting the unit. Do not lift or place supports on any part of the suspension system.

****Note: Trailer Brake Adjustment procedures courtesy Dexter Axle.**



AUTOMATIC
DISTRIBUTORS

TRAILER CATALOG

**TRAILER
HARDWARE**

TRAILER HARDWARE

- tires & wheels
- axles, hubs & springs
- tongue accessories
- hitches
- electrical
- brake parts
- trailer hardware
- locks & pins
- towing & loading
- tie downs
- tools
- chemicals

ERICKSON RECESSED RINGS

PART #	MFG #	DESCRIPTION	MAX LOAD RATING	UM
EK59109	4.95 59109	RECESSED RING ROUND BULK	1200#	EA
EK9128	13.95 09128	RECESSED ANCHOR RING PACKAGED	1200#	EA
EK59128	9.95 59128	RECESSED ANCHOR RING BULK	1200#	EA
EK9114	21.95 09114	HEAVY DUTY RECESSED RING PACKAGED	5000#	EA
EK59114	21.95 59114	HEAVY DUTY RECESSED RING BULK	5000#	EA
EK9098	6.95 09098	RECESSED OVAL ANCHOR PACKAGED	1200#	EA
EK59098	9.95 59098	RECESSED OVAL ANCHOR BULK	1200#	EA
EK9097	8.95 09097	HEAVY DUTY RECESSED OVAL ANCHOR PACKAGED	5000#	EA
EK59097	12.95 59097	HEAVY DUTY RECESSED OVAL ANCHOR BULK	5000#	EA
EK59130	21.95 59130	HEAVY DUTY SWIVEL RECESSED RING BULK	5000#	EA
EK9110	10.95 09110	RECESSED RING PACKAGED	1200#	EA
EK59110	6.95 59110	RECESSED ROUND BULK	1200#	EA



Buyers RECESSED RINGS

PART #	MFG #	DESCRIPTION	SAFE LOAD RATING	UM
BY601	6.08 B601U	3" DIAMETER MOUNTING HOLE REQUIRED ZINC PLATED DISPLAY PACKAGED	285#	EA
BY501	2.95 B501	SURFACE MOUNTED STEEL PAN WITH 1/4" DIAMETER RING ZINC PLATED BULK	500#	EA
BY701S	5.80 B701SM	3" DIAMETER MOUNTING HOLE REQUIRED ZINC PLATED DISPLAY PACKAGED	265#	EA
BY703	6.62 B703	SURFACE/RECESSED ZINC PLATED ROPE RING	500#	EA
BY705	3.74 B705	PLASTIC PAN WITH 1/4" DIA. RING BULK	1000#	EA
BY8011	11.68 B801A	FORMED 1/8" STEEL PAN ZINC PLATED DISPLAY PACKAGED	1670#	EA
BY901	29.32 B901	ROTATES 360 BOLT THROUGH OR WELD ON BULK	2000#	EA



ERICKSON STAKE POCKET ANCHORS

PART #	MFG #	DESCRIPTION	MAX LOAD RATING	UM
EK4001	60.95 4001	STAKE POCKET ANCHOR RETRACTABLE DISPLAY PACKAGED	1000#	PR
EK51007	4.95 51007	STAKE POCKET TIE DOWN BULK		EA
EK01005	30.95 01005	STAKE POCKET ANCHOR CHROME DISPLAY PACKAGED		PR
EK51008	9.95 51008	STAKE POCKET TIE DOWN CHROME BULK		EA
EK9085	33.95 09085	COMBINATION STAKE POCKET ANCHOR PACKAGED	2000#	PR
EK1011	28.95 01011	TOGGLE STAKE POCKET ANCHOR CHROME DISPLAY PACKAGED		PR
EK51011	13.95 51011	TOGGLE STAKE POCKET ANCHOR CHROME BULK		EA



Buyers DOOR HOLDS

PART #	MFG #	DESCRIPTION	LENGTH	UM
BY500	6.68 DH500SS	HOOK & KEEPER DOOR HOLDER STAINLESS STEEL	4"	KIT
BY2595	10.26 B2595LKB	SPRING LATCH WITH KEEPER 1/2" BOLT. BULK	4-1/2"	EA



BY500

TRAILER

ERICKSON SURFACE MOUNT WIRE RINGS

PART #	MFG #	DESCRIPTION	MAX LOAD RATING	UM
EK9108	10.95 09108	SURFACE MOUNT WIRE RING PACKAGED	1200#	PR
EK59108	4.95 59108	SURFACE MOUNT WIRE RING BULK	1200#	EA
EK9111	17.95 09111	HEAVY DUTY SURFACE MOUNT RING PACKAGED	11,000#	EA
EK59111	14.95 59111	HEAVY DUTY SURFACE MOUNT RING BULK	11,000#	EA
EK59168	22.95 59168	WELD ON FLIP ANCHOR BULK 5/8"	15,000#	EA
EK59169	30.95 59169	WELD ON FLIP ANCHOR BULK 3/4"	20,000#	EA
EK9113	10.95 09113	4-BOLT SURFACE MOUNT RING PACKAGED	2000#	EA
EK59113	6.95 59113	4-BOLT SURFACE MOUNT RING BULK	2000#	EA



tires & wheels



axles, hubs & springs



tongue accessories



hitches

Buyers SURFACE MOUNT WIRE RING



PART #	MFG #	DESCRIPTION	SAFE LOAD RATING	UM
BY32	5.14 B32F	ZINC PLATED 3/8" DIA. FORGED ROPE RING DO NOT USE FOR LIFTING BULK	2000#	EA
BY28	8.50 B28F	HEAVY DUTY WELD ON ROPE RING BULK	1000#	EA
BY20	2.58 B20	SURFACE MOUNTED RING WITH FORGED STEEL CLAMP BULK	800#	EA
BY21	2.72 B21	SURFACE MOUNTED ROPE RING 1/4" BLACK ZINC BULK	800#	EA
BY23	4.16 B23SS	ROPE RING STAINLESS STEEL BULK	1000#	EA



electrical

brake parts

trailer hardware

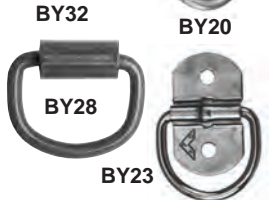

locks & pins

towing & loading

ERICKSON TIE DOWN ANCHORS

PART #	MFG #	DESCRIPTION	MAX LOAD RATING	UM
EK9094	38.95 09094	HIDE-A-HOOK GASKETS & MOUNTING HARDWARE INCLUDED	1200#	PR
EK9095	30.95 09095	STAINLESS STEEL ANCHOR DISPLAY PACKAGED	1200#	EA
EK59095	12.95 59095	STAINLESS STEEL ANCHOR BULK	1200#	EA
EK9090	27.95 09090	HORSE SHOE ROPE CLEAT ZINC PLATED PACKAGED		PR
EK9091	14.95 09091	SWING OUT HOOKS SPRING LOADED SCREWS INC		PR



tie downs



tools

chemicals



TIE DOWN THREADED LINKS



PART #	MFG #	DESCRIPTION	SIZE	UM
LR50648	3.47 50648	QUICK CONNECTION ZINC FINISH TIGHTENS W/ FINGERS PACKAGED	5/16"	EA
LR50649	5.05 50649	QUICK CONNECTION ZINC FINISH TIGHTENS W/ FINGERS PACKAGED	3/8"	EA

ERICKSON O-TRACK

PART #	MFG #	DESCRIPTION	UM
EK09133	33.95 09133	O-TRACK W/2 CLIP RINGS - 18" VERTICAL CLAM SHELL PACKAGING	EA

- 18" Length
- With 2 movable rings
- Aluminum design
- Extra rings available

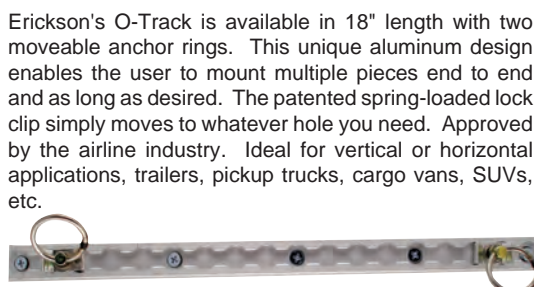

2-PACK
REPLACEMENT
ANCHOR
RINGS

EK59132 ea (bulk) 6.95

FAST SAME DAY SHIPPING

TRAILER

TRAILER HARDWARE

- tires & wheels
- axles, hubs & springs
- tongue accessories
- hitches
- electrical
- brake parts
- trailer hardware
- locks & pins
- towing & loading
- tie downs
- tools
- chemicals



QUICK LINK CONNECTOR

PART #	MFG #	DESCRIPTION	SIZE	UM
BY0038	4.40	7350038 BUYERS QUICK LINK CONNECTOR ZINC PLATED BULK	3/8"	EA



HOOD CATCHES

PART #	MFG #	DESCRIPTION
BY195	5.00	WJ195 4" EASY GRIP WITH BRACKET*
218000	5.26	WJ201A 4-7/8" RUBBER HOOD CATCH WITH "A" BRACKET
218001	5.04	WJ201H 4-7/8" RUBBER HOOD CATCH WITH BLACK "A" BRACKET
218002	7.10	WJ201SS 4-7/8" RUBBER HOOD CATCH WITH "A" BRACKET STAINLESS STEEL BRACKET
BY201	5.26	WJ201U 4-7/8" RUBBER HOOD CATCH
BY202	5.30	WJ202 2 1/2" EASY GRIP WITH BRACKET
BY205	11.02	WJ205 6" RUBBER HOOD CATCH
218003	6.68	WJ205RO 6" HEAVY DUTY RUBBER HOOD CATCH HANDLE ONLY NO BUMPER
218004	11.00	WJ206 6" HEAVY DUTY RUBBER HOOD CATCH INCLUDES BRACKETS AND PINS
218005	6.70	WJ206RO 6" HEAVY DUTY RUBBER HOOD CATCH HANDLE ONLY
218006	13.70	WJ208 7-7/8" HEAVY DUTY RUBBER HOOD CATCH INCLUDES BRACKETS AND PIN
218007	9.12	WJ208RO 7-7/8" HEAVY DUTY RUBBER HOOD CATCH HANDLE ONLY
218008	22.36	WJ211 12" ULTRA RUBBER/POLYMER HOOD CATCH**
218009	30.98	WJ212 9" RUBBER/POLYMER DRAW LATCH***
218010	32.82	WJ213 13-1/4" RUBBER/POLYMER DRAW LATCH****
218011	7.86	WJ215 4-1/4" RUBBER/POLYMER DRAW LATCH
BY960	6.15	WJ96WCB HOOD CATCH WITH KEEPER & HARDWARE



BY202



BY201

BY205

*COMPARES TO SOUTHCO PART NO. 37-10-086-10 **COMPARES TO STANDARD NAVISTAR HOOD CATCH
 COMPARES TO SOUTHCO PART NO. 37-30-294-60 *COMPARES TO SOUTHCO PART NO. 37-140-295-60



DRAW LATCHES

PART #	MFG #	DESCRIPTION	UM
BY225	10.02	WJ225 HEAVY DUTY ADJUSTABLE DRAW LATCH ZINC PLATED STEEL BULK	EA
BY207	4.04	BHC207Z PADLOCK EYE PULL-DOWN CATCH WITH STRIKER ZINC PLATED STEEL. BULK	EA
BY227	2.66	BHC227Z LARGE PADLOCK EYE PULL-DOWN CATCH WITH STRIKER ZINC - PLATED STEEL. BULK	EA
BY801	3.54	BHC801Z PULL DOWN CATCH - HOOK STYLE ZINC PLATED STEEL. BULK	EA



BY225

BY801

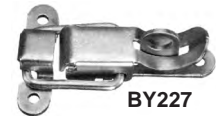

BY227



HANDLES

PART #	MFG #	DESCRIPTION	LENGTH	UM
BY2399	15.92	B2399B2C DIE CAST GRAB HANDLE BULK	8-1/4"	EA
BY2344	3.88	B2344 CHEST HANDLE ZINC PLATED BULK	4"	EA



BY2399



BY2344



HINGE

PART #	MFG #	DESCRIPTION	LENGTH	UM
BYA23	33.06	A23 CONTINUOUS HINGE ALUMINUM EQUAL LEAVES FULL HARD ALUMINUM PINS	72"	EA
BY2158	45.46	B2159C CAM ACTION DOOR LOCK KIT. CAST STEEL CUPS, STEEL HANDLE, AND SUPPORTS 3/4" PIPE NOT INCL		KIT
BY2423	26.78	B2423H STRAP HINGE 16"	16"	EA
BY2424	10.86	B2424SS STAINLESS STEEL STRAP HINGE	3-5/8"	EA



BY2423



BYA23



BY2424

ERICKSON CARGO BARS

PART #	MFG #	DESCRIPTION	UM
EK8906	74.95	08906 CARGO BAR LEVER ACTION 88" - 103"	EA
EK8907	70.95	08907 CARGO BAR LEVER ACTION 60" - 75"	EA

TRAILER



STAKE BODY COMPONENTS

PART #	MFG #	DESCRIPTION	LENGTH	UM
BY2585	22.70	B2585BZ RACK CONNECTOR STRAIGHT - ZINC 4PC		SET
BY2591	18.42	B2591BZ RACK CONNECTOR CORNER - ZINC 4PC		SET
BY2588	17.78	B2588BZ SECURITY LATCH STRAIGHT 4PC		SET
BY2589	16.52	B2589BZ SECURITY LATCH - CORNER 4PC		SET
BY1454	105.34	SA1454WDNH STAKE ASSEMBLY 14 GAUGE STEEL	54"	EA
BY166548	58.22	LS166548 LINER SLAT 6-1/2" WIDE ROLLED STEEL	47.25"	EA
BY25901	14.52	B2590LH STAKE BODY SPRING LATCH L.H 1/2" ASSEMBLY		EA
BY25903	14.52	B2590RH STAKE BODY SPRING LATCH R.H 1/2" ASSEMBLY		EA
BY25905	8.86	B2590KZ 90° KEEPER FOR SPRING LATCH		EA



BY2591



BY2585



BY2588



STAKE POCKETS

PART #	MFG #	DESCRIPTION	DEPTH	UM
BY2373W	4.90	B2373W STRAIGHT WELD ON STAKE POCKETS. BULK INSIDE DIMENSIONS 3" X 1-1/2"	2-1/2"	EA
BY2373R	8.24	B2373R STRAIGHT WELD ON STAKE POCKETS. BULK INSIDE DIMENSIONS 3-1/2" X 1-1/2"	3"	EA
BY2373G	5.74	B2373G STRAIGHT BOLT ON STAKE POCKETS. BULK INSIDE DIMENSIONS 3" X 1-1/2"	2-1/2"	EA
BY2374G	5.42	B2374G TAPERED BOLT ON STAKE POCKETS. BULK. INSIDE DIMENSION 3"X1-1/2" TOP 2-7/8"X1-1/2" BOTTOM	2-1/2"	EA



BY2373W
BY2373R



BY2373G
BY2374G



SMITH STAKE POCKET

PART #	DESCRIPTION	DEPTH	UM
235004	7.95 BOLT ON STAKE POCKET HOLDS 2"X4" 5/8" BOLT HOLE	2"	EA



235004

ERICKSON TIE HOOKS

PART #	MFG #	DESCRIPTION	UM
EK9092	7.95	09092 TIE HOOK - ZINC (PKG 4) DISPLAY PACKAGE	PKG



EK9092



SMITH 'S' HOOKS

PART #	DESCRIPTION	LOAD RATING	UM
CS16640	1.95 FOR TRAILER SAFETY CHAIN CLASS I BULK	2000#	EA
CS16642	1.75 FOR TRAILER SAFETY CHAIN CLASS III BULK	5000#	EA



CS16640



ANCHOR SHACKLES

PART #	MFG #	DESCRIPTION	LOAD RATING	UM
BY80375	3.26	5480375 GALVANIZED ANCHOR SHACKLE 3/8" BULK	1TON	EA



BY80375

tires & wheels

axles, hubs & springs

tongue accessories

hitches

electrical

brake parts

trailer hardware

locks & pins

towing & loading

tie downs

tools

chemicals

TRAILER

- tires & wheels
- axles, hubs & springs
- tongue accessories
- hitches
- electrical
- brake parts
- trailer hardware
- locks & pins
- towing & loading
- tie downs
- tools
- chemicals

TRAILER

ERICKSON E-TRACKS

PART #	MFG #	DESCRIPTION	UM
EK9146	31.95 19146	E-TRACK VERTICAL - 4FT BULK	EA

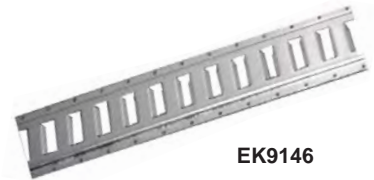

Buyers E-TRACKS

PART #	MFG #	DESCRIPTION	UM
EK9148	38.95 1903055	E-TRACK HORIZONTAL 5' BULK	EA
EK9150	13.95 1903052	E-TRACK HORIZONTAL - 2' BULK	EA



ERICKSON TIE OFF RING

PART #	MFG #	DESCRIPTION	LOAD RANGE	UM
EK9131	12.95 59131	E-TRACK TIE OFF RING BULK	4000#	EA
EK9147	16.95 59147	E-TRACK TIE OFF RING BULK	6000#	EA



Buyers TIE OFF RING

PART #	MFG #	DESCRIPTION	LOAD RANGE	UM
BY01090	7.06 01090	E-TRACK TIE OFF RING BULK	6000#	EA

ERICKSON E-TRACK WOOD BEAM SOCKET

PART #	MFG #	DESCRIPTION	UM
EK9149	12.95 59149	WOOD BEAM SOCKET HOLDS 2X4 & 2X6 BULK	EA

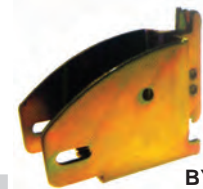

Buyers WOOD BEAM SOCKET

PART #	MFG #	DESCRIPTION	UM
BY01100	7.96 01100	BUYERS E-TRACK WOOD BEAM SOCKET	EA

ERICKSON TRAILER STRAPS

PART #	MFG #	DESCRIPTION	LOAD RATING	UM
EK2300	42.95 02300	RATCHET STRAP 2" X 15' DOUBLE "J" HOOKS PACKAGED	5000#	EA
EK2400	44.95 02400	RATCHET STRAP 2" X 25' DOUBLE "J" HOOKS PACKAGED	5000#	EA
EK68655	46.95 68655	2"X27' RATCHET STRAP CAMO BULK	10,000#	EA



ERICKSON TOW POINTS

PART #	MFG #	DESCRIPTION	LOAD RATING	UM
EK9509	20.95 09509	ERICKSON'S TOW HOOK - CHROME	10,000#	EA
EK9510	8.95 09510	ERICKSON'S TOW HOOK - BLACK POWDER COATED	10,000#	EA
EK57500	84.95 57500	HITCH RECEIVER SWIVEL CLEVIS		EA





AUTOMATIC
DISTRIBUTORS

TRAILER CATALOG

LOCKS & PINS

LOCKS & PINS



Dare To Compare! TRIMAX, The Absolute Leader in Receiver Locking Pin Technology. TRIMAX has spent the last 15 years expanding and improving on the "Original", patented Dual Lock Lug Design.

LOOK ALIKES DO NOT LOCK ALIKE!!
BUY ONLY TRIMAX BRANDED PARTS.

What makes all Trimax Locking Pins the Strongest You Can Buy?

Patented Design Incorporates
 Internal O-ring
 & Water Tight Cap
 Helps to Seal Out Dirt

Rugged keys won't
 bend or break

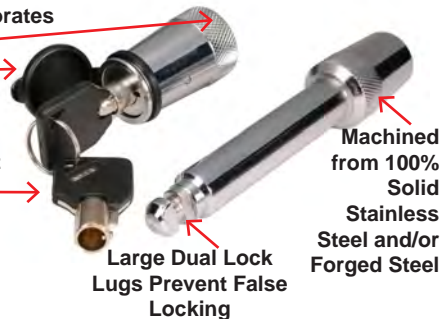

Machined from 100% Solid Stainless Steel and/or Forged Steel

Large Dual Lock Lugs Prevent False Locking

- No internal springs to seize up or break
- Keyed-alike sets available for adjustable hitches
- Ideal for securing hitch receivers, bike carriers, ornamental receiver plugs and swing away trailer hitches
- Unmatched durability and corrosion protection

RECEIVER LOCKING PIN

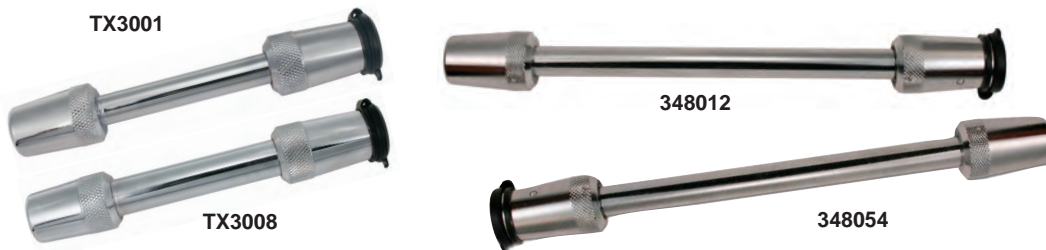

348055

PART #	MFG #	DESCRIPTION	UM
TX3001	22.95 T2	Machine Forged Chrome Steel, 1/2" x 2-3/4" Span	EA
TX3008	22.95 T3	Machine Forged Chrome Steel, 5/8" x 2-3/4" Span	EA
348012	36.99 T5	Machine Forged Chrome Steel, 5/8" x 3-1/2" Span Fits Class V Hitches	EA
348053	42.99 TH4	Machine Forged Chrome Steel, Adjustable Hitch Lock, 5/8" x 4-3/8" Span	EA
348054	43.99 TH6	Machine Forged Chrome Steel, 5/8" x 6-1/8" Span, Swing Away Trailer Lock	EA
348055	76.99 TH43	"Rapid Hitch" Keyed-Alike Adjustable Receiver Lock Set	EA

EPOXY POWDER COATED LOCKING PIN



TX3002

PART #	MFG #	DESCRIPTION	UM
TX3002	23.95 T3-Black	Premium 5/8" Key Receiver Lock Rugged Black Epoxy Powder Coat	EA

100% STAINLESS STEEL LOCKING PIN



348056



348057

PART #	MFG #	DESCRIPTION	UM
348056	46.99 SXT3	Premium 100% Stainless Steel 5/8" Key Receiver Lock	EA
348057	49.99 SXT5	Premium 100% Stainless Steel 5/8" Key Receiver Lock, 3-1/2" Span	EA

TRAILER

- tires & wheels
- axles, hubs & springs
- tongue accessories
- hitches
- electrical
- brake parts
- trailer hardware
- locks & pins
- towing & loading
- tie downs
- tools
- chemicals



"Lock It Or Lose It"

ANTI RATTLE RECEIVER PIN



- ➔ Easily Adjust Receiver Pin for Tight Fit
- ➔ Includes 2 Rugged Keys

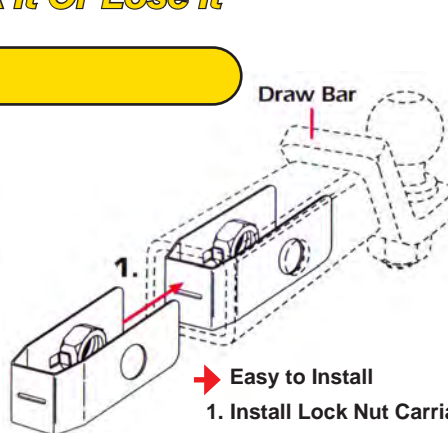

➔ Easy to Install

1. Install Lock Nut Carriage into Draw Bar, Align with Holes
2. Slide Draw Bar into Receiver, Insert Lock Pin & Tighten
3. Insert 5/8" Head & Attach Lock Head

PART #	MFG #	DESCRIPTION	UM
348058	48.99	TAR300 Premium 5/8" Wobble Key Receiver Lock	EA

UNIVERSAL FIT LOCKING PIN

➔ Convert from 1/2" to 5/8"

1. Remove Lock Head
2. Slide 5/8" Stainless Steel Sleeve onto Pin Shaft
3. Install in Receiver & Replace Lock Head



PART #	MFG #	DESCRIPTION	UM
348015	35.99	TS32 Universal Receiver Lock - Fits 1/2" & 5/8" w/Sleeve	EA
348016	48.99	SXTS32 100% Stainless Steel Universal Receiver Lock - Fits 1/2" & 5/8" w/Stainless Steel Sleeve	EA

TS2000

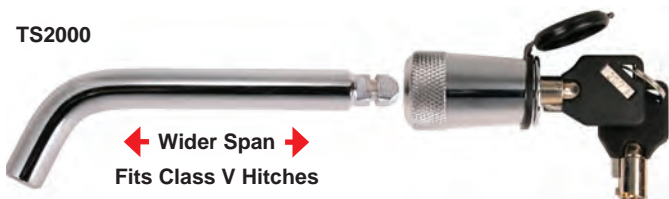

➔ Wider Span
Fits Class V Hitches

TX1998



1/2" Pin fits all Class II Receiver Hitches

PART #	MFG #	DESCRIPTION	UM
TX2000	29.99	TR200 Deluxe 5/8" Key Receiver Lock, 3-1/2" Span	EA
TX1998	29.99	TR125 Deluxe 1/2" Key Receiver Lock, Fits 1-1/4" Class II Receivers	EA



RESETTABLE COMBINATION LOCKING PIN

Durable Non-Corrosive Locking Mechanism



Easy To Read Numbers

Forged Steel Lock Tip

➔ Heavy Duty Collar Overlaps Hitch Pin For Unmatched Strength & Security



Set Your Own Personalized Combination

➔ Triple Chrome Plated Steel Pin

➔ Protective Lock Head Cover Included



PART #	MFG #	DESCRIPTION	UM
348014	33.99	MAG200 Resettable Combination Receiver Bent Pin Lock 5/8"	EA
348013	33.99	MAG125 Resettable Combination Receiver Bent Pin Lock 1/28"	EA

- tires & wheels
- axles, hubs & springs
- tongue accessories
- hitches
- electrical
- brake parts
- trailer hardware
- locks & pins
- towing & loading
- tie downs
- tools
- chemicals

TRAILER

- tires & wheels
- axles, hubs & springs
- tongue accessories
- hitches
- electrical
- brake parts
- trailer hardware
- locks & pins**
- towing & loading
- tie downs
- tools
- chemicals



"Lock It Or Lose It"

"FLIP-TIP" PINS

Easy to Install

1. Squeeze Tip & Push Down Head
2. Rotate Tip Forward for Insertion into or Removal from Receiver
3. Once Pin is Through Receiver Hole, Rotate Tip Downward Until Tip "SNAPS" Firmly into Place.



Triple Chrome Plated or Premium Stainless Steel

→ 1/2" Pin Fits all Class I & II Receivers

→ 5/8" Pin Fits all Class III, IV & V Receivers

PART #		MFG #	DESCRIPTION	UM
348017	12.99	TX125	Chrome Plated "FLIP-TIP" 1/2" Receiver Pin & Clip	EA
348018	12.99	TX200	Chrome Plated "FLIP-TIP" 5/8" Receiver Pin & Clip	EA
TX1255	17.99	SXTX125	Premium Stainless Steel "FLIP-TIP" 1/2" Receiver Pin & Clip	EA
TX2005	17.99	SXTX200	Premium Stainless Steel "FLIP-TIP" 5/8" Receiver Pin & Clip	EA

PIN & CLIPS



Triple Chrome Plated

→ 1/2" Pin Fits all Class I & II Receivers

→ 5/8" Pin Fits all Class III, IV & V Receivers

PART #		MFG #	DESCRIPTION	UM
TX1258	9.99	SP125	Steel Pin & Clip 1/2" Receiver Pin	EA
TX2010	10.99	SP200	Steel Pin & Clip 5/8" Receiver Pin	EA

MULTI-USE COUPLER TRIGGER

Great for Trailer Door Latches & Cargo Boxes

→ Easy 1/4 Turn of Key to Lock & Unlock for Maximum Security

→ Internal O-Ring in Lock Body & Weather Proof Cap help Seal out Grime and Corrosion



Available in Both Flat & Round Keys



PART #		MFG #	DESCRIPTION	UM
348022	21.99	TMC10	Deluxe Coupler/Door Latch Lock - Fits Couplers w/up to 7/8" Span	EA

TRAILER



"Lock It Or Lose It"

MACHINE HARDENED STEEL LOCKING PINS

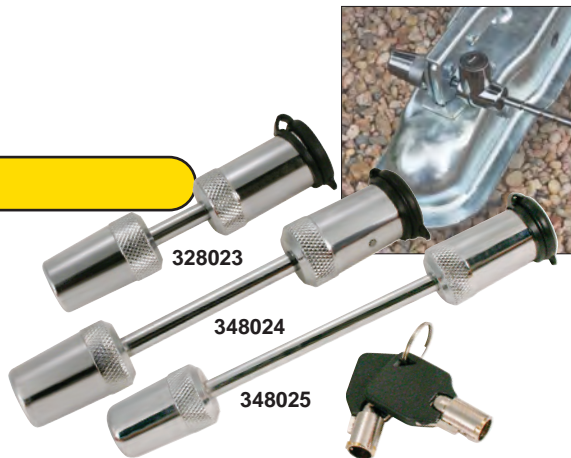
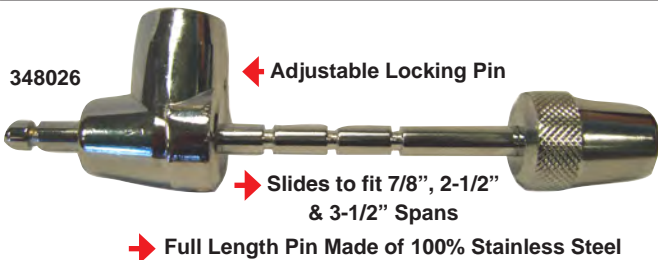

PART #	MFG #	DESCRIPTION	UM
348023	23.99 TC1	Coupler/Door Latch Lock Fits Couplers w/up to 7/8" Span	EA
348024	24.99 TC2	Coupler Lock Fits Couplers w/up to 2-1/2" Span	EA
348025	25.99 TC3	Coupler Lock Fits Couplers w/up to 3-1/2" Span	EA
348026	25.99 TC123	Adjustable Coupler Lock Fits Couplers from 7/8", 2-1/2" to 3-1/2" Spans	EA

KEYED ALIKE SETS

PART #	MFG #	DESCRIPTION	UM
348027	58.99 TM31	TX3008 - 5/8" Receiver Lock & 348023 - 7/8" Span Coupler Lock	SET
348028	58.99 TM32	TX3008 - 5/8" Receiver Lock & 348024 - 2-1/2" Span Coupler Lock	SET
348029	58.99 TM33	TX3008 - 5/8" Receiver Lock & 348025 - 3-1/2" Span Coupler Lock	SET
348030	58.99 TM3123	348015 - Universal Fit Locking Pin & 348026 Adjustable Coupler Lock	SET



100% STAINLESS STEEL LOCKING PINS

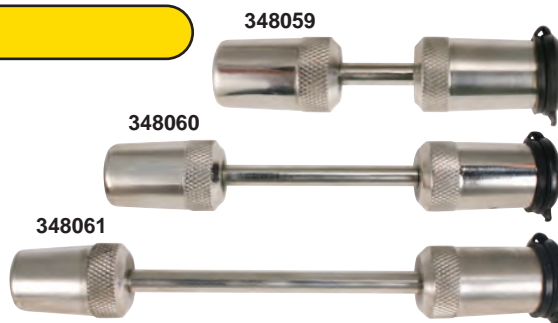

PART #	MFG #	DESCRIPTION	UM
348059	39.99 SXC1	Premium Stainless Steel Coupler//Door Latch Lock Fits Couplers 7/8" Span	EA
348060	41.99 SXC2	Premium Stainless Steel Coupler Lock Fits Couplers w/up to 2-1/2" Span	EA
348061	41.99 SXC3	Premium Stainless Steel Coupler Lock Fits Couplers w/up to 3-1/2" Span	EA
348062	39.99 SXC123	Adjustable Stainless Steel Coupler Lock Fits 7/8", 2-1/2" to 3-1/2" Spans	EA

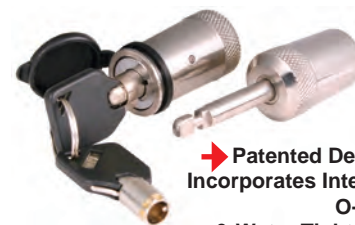

STAINLESS STEEL KEYED ALIKE SETS

PART #	MFG #	DESCRIPTION	UM
348063	70.99 SXTM31	Stainless Steel 348056 - 5/8" Receiver Lock & 348059 - 7/8" Span Coupler Lock	SET
348064	71.99 SXTM32	Stainless Steel 348056 - 5/8" Receiver Lock & 348060 - 2-1/2" Span Coupler Lock	SET
348065	72.99 SXTM33	Stainless Steel 348056 - 5/8" Receiver Lock & 348061 - 3-1/2" Span Coupler Lock	SET
348066	84.99 SXTM3123	Stainless Steel 348016 - Universal Fit Locking Pin & 348062 Adjustable Coupler Lock	SET



- tires & wheels
- axles, hubs & springs
- tongue accessories
- hitches
- electrical
- brake parts
- trailer hardware
- locks & pins
- towing & loading
- tie downs
- tools
- chemicals

TRAILER

FAST SAME DAY SHIPPING

TRAILER CATALOG

LOCKS & PINS

- tires & wheels
- axles, hubs & springs
- tongue accessories
- hitches
- electrical
- brake parts
- trailer hardware
- locks & pins
- towing & loading
- tie downs
- tools
- chemicals



"Lock It Or Lose It"

UNIVERSAL COUPLER LOCKS



➔ Patented Dual Lock System



PART #	MFG #	DESCRIPTION	UM
348019	72.99 UMAX50	Universal "Die-Cast" Dual Purpose Coupler (Fits Most Couplers)	EA
TX1005	115.99 UMAX100	Premium Universal 360° of "Solid Hardened Steel" Dual Purpose Coupler Lock (Fits Most Couplers)	EA



KEYED ALIKE KITS

- ➔ Ultimate Protection for Work & Play
- ➔ Includes Carrying Case
- ➔ 3 Locks - 1 Key!



PART #	MFG #	DESCRIPTION	UM
348020	174.99 TCP100	Combo Pack Keyed Alike Set, Includes TX1005, 348026 - Adjustable Coupler Lock Fits Couplers from 7/8", 2-1/2" to 3-1/2" Spans, 348015 - 5/8" or 1/2" Universal Receiver Lock	EA
348021	130.99 TCP50	Combo Pack Keyed Alike Set, Includes 348019, 348026 - Adjustable Coupler Lock Fits Couplers from 7/8", 2-1/2" to 3-1/2" Spans, 348015 - 5/8" or 1/2" Universal Receiver Lock	EA

TRAILER

- tires & wheels
- axles, hubs & springs
- tongue accessories
- hitches
- electrical
- brake parts
- trailer hardware
- locks & pins**
- towing & loading
- tie downs
- tools
- chemicals

TRAILER

TRIMAX™ "The World's Toughest Locks" MAX SECURITY FOR ALL APPLICATIONS!

LUNETTE LOCK



Lunette Tow Ring Security Lock
MAX Security for Unattended Pintle Hook Trailers

- Made from Heavy Duty Weather Resistant Metal Alloy
- Fits 2-7/8" Inside Diameter
- Easy to Install
- Includes 2 Rugged Keys

PART #	DESCRIPTION
348032	Lunette Two Ring Lock 2-7/8 " Inside Diameter

5th WHEEL LOCK



MAX Security for Unattended 5th Wheel Trailers

- Constructed of Heavy Gauge Alloy for Added Security
- Rugged Weather Proof Epoxy Powder Coat Finish prevents Rust
- Easy to Install - Unlock TFWSS, lock head will spring out from the lock. Slide lock up to cover hitch. Push in lock head and turn key
- Includes 3 Rugged Keys

PART #	MFG #	DESCRIPTION	UM
348033	TFW55	5th Wheel Trailer Lock	EA

ULTRA -MAX WHEEL LOCKS



- Heavy Gauge Steel Disc Covers Lug Nuts to Prevent Tire Removal
- Clamps Tight to Wheel for Added Security
- Fits Almost all 10" - 18" Wheels

PART #	MFG #	DESCRIPTION	UM
TX0100	363.99	TWL100 Adjustable Wheel Lock - Fits Nearly All 10" - 18" Wheels	EA

"Chock It & Lock It"

- Quick & Easy Installation for Unattended Trailers, Construction Equipment, Cars, Boats, ATV'S & More
- Rubber Coated Arms to Protect Wheel Finish
- High Strength Pick Resistant Locking Mechanism with Cover to Help Keep Out Dirt and Grime

PART #	DESCRIPTION	UM
TX0175	138.99 Universal "Die-Cast" Dual Purpose Coupler (Fits Most Couplers)	EA

WALL FLOOR ANCHOR



Ideal for Securing Lawn Furniture, Bicycles, Tools, Motorcycles & More. Mounts Anywhere! Use with TRIMAX Cables & Chains

348067	54.99
--------	-------

WATERCRAFT LOCKS

PART #	MFG #	DESCRIPTION	UM
348009	43.99	T6 TRIMAX WATERCRAFT LOCKING PIN 5-1/2" X 1/2"	EA
348010	65.99	TBL610 OUTBOARD MOTOR LOCK	EA



FAST SAME DAY SHIPPING



"THE WORLD'S TOUGHEST LOCKS™"

- tires & wheels
- axles, hubs & springs
- tongue accessories
- hitches
- electrical
- brake parts
- trailer hardware
- locks & pins
- towing & loading
- tie downs
- tools
- chemicals

IRON CLAD ARMOR PLATED LOCKS

- All are ballistic grade covered with durable PVC skin to prevent scratching
- Ideal for bicycles, motorcycles, spare tire, trailer, marine and more
- All come with 3 ultra secure "Wise Keys"
- One key is a mini flashlight
- Flexible for easy transport
- Display packaged



TX2236 36.99	TX3048 49.99	TX3072 71.99
36" x 22mm	48" x 26mm	72" x 26mm

BRAIDED & COILED QUADRA-BRAID™ LOCK

- Armor plated
- Repels saw cuts and bolt cutters
- Comes with: 3 keys - one with a mini flashlight



TX1532 23.99	32" x 15mm
---------------------	------------

TRIMAFLEX™ DUAL LOOPED CABLE

- Exclusive MAX security quadra braid multi-use cables
- For maximum protection use with **TX6000** and **TX4004** for the ultimate in multi-use security



TX8150 25.99	8' x 15mm
---------------------	-----------



TX1212 25.99	12' x 12mm
---------------------	------------



TX1510 24.99	15' x 10mm
---------------------	------------



TX3010 43.99	30' x 10mm
---------------------	------------

MAX-DUAL FORCE U-CABLE LOCK

- Multi use combined cable and u-lock system - the best of both worlds
- The security of a mini u-lock combined with the versatility of a cable
- Max dual force lock system features exclusive Trimaflex™ quadra braid cable for maximum theft prevention



TX1572 34.99	72" x 15mm
---------------------	------------

MULTI-PURPOSE SPARE TIRE LOCK

- The only spare tire lock that secures both spare tire and tire bracket to welded frame member!
- Locks through wheel lug nut hole for maximum security
- Ideal for securing spare tires on: boat trailers, jeeps, trucks, and vans



TX3000 29.99	36" x 12mm
---------------------	------------

QUADRA-BRAID™ LOCK

- Integrated keyed cable locks with quick release bracket
- Ballistic grade polymer lock housing for durability
- Display packaged



TX3600 29.99	6' x 12mm
---------------------	-----------

COMBINATION CABLE LOCK

- A multi-use resettable combination cable lock featuring an exclusive TRIMAFLEX ultra tough braided cable (10 feet long x 8mm diameter) and a combination lock head
- Ideal for securing bikes, bike carriers, watercraft on the beach, trailers and much, much more



348000 28.99	10' x 8mm
---------------------	-----------



TRAILER



MAX SECURITY FOR ALL APPLICATIONS!

3' X 10 MM ALARM LOCK AND THEX SUPER CHAIN



- Alarm locking mechanism sets off 110 decibel ear piercing scream when moved or tampered with
- Withstands 6 tons of pulling force and 11 tons of cutting force
- Durable nylon sleeve protects against scratches

348037 123.99

INTEGRATED LOCK & SUPER CHAIN 6MM LINKS X 36" LENGTH



- Large hexagon shaped 6 mm links
- High strength combination chain lock
- No keys to break or lose
- Anti-drill and pick resistant lock mechanism

348034 49.99

4' X 25 MM ALARM LOCK AND QUADRA-BRAID CABLE



- Alarm locking mechanism sets off 110 decibel ear piercing scream when moved or tampered with
- Withstands 6 tons of pulling force and 11 tons of cutting force
- Features exclusive 25 millimeter TRIMAFLEX Quadra-braid cable for max security

348038 123.99

INTEGRATED LOCK & SUPER CHAIN 8MM LINKS X 36" LENGTH



- Large hexagon shaped 8 mm links
- Durable NYLOMEX sleeve protects against scratches
- Ballistic grade polymer lock housing cover resists hammer strikes and protects lock mechanism
- Patented key cover resists grime and moisture
- Withstands over 6 tons of pull force and 11 tons of cutting force

348035 43.99

6' X 25 MM ALARM LOCK AND QUADRA-BRAID CABLE



- Alarm locking mechanism sets off 110 decibel ear piercing scream when moved or tampered with
- Withstands 6 tons of pulling force and 11 tons of cutting force
- Features exclusive 25 millimeter TRIMAFLEX Quadra-braid cable for max security

348039 136.99

INTEGRATED LOCK & SUPER CHAIN 10MM LINKS X 36" LENGTH



- Large hexagon shaped 10 mm links
- Durable NYLOMEX sleeve protects against scratches
- Ballistic grade polymer lock housing cover resists hammer strikes and protects lock mechanism
- Patented key cover resists grime and moisture
- Withstands over 6 tons of pull force and 11 tons of cutting force

348036 58.99

HIGH SECURITY GENERAL PURPOSE CABLE U-LOCKS - MAX 60

- Chrome shackle
- Use on motorcycle discs & looped cables
- The strongest short shackle locks you can buy
- Display packaged

PART #	DESCRIPTION
TX4004 34.99	Max 40, Yellow
TX4002 34.99	Max 40, Black



FAST SAME DAY SHIPPING

TRAILER CATALOG 173

- tires & wheels
- axles, hubs & springs
- tongue accessories
- hitches
- electrical
- brake parts
- trailer hardware
- locks & pins
- towing & loading
- tie downs
- tools
- chemicals

TRAILER

- tires & wheels
- axles, hubs & springs
- tongue accessories
- hitches
- electrical
- brake parts
- trailer hardware
- locks & pins
- towing & loading
- tie downs
- tools
- chemicals

"THE WORLD'S TOUGHEST LOCKS™"

MULTI-USE VERSA-CABLE LOCK

- 6' X 10MM TRIMAFLEX CABLE**
- 6" vinyl coated steel cable (lock not included)
 - Quick installation
 - Ideal for securing and locking: bike racks, jet skis, motorcycles, and furniture
 - Retail packaged
 - 12' and 30' replacement cables sold separately, see below

TX1006 39.99 6' x 10mm



- Recommended Uses:**
- Bicycles
 - Power Tools
 - Patio Furniture
 - BBQ Grills
 - Sports Equipment
 - Fire Arms
 - Power Sports
 - Marine Toys - Wakeboards, Towables, Jet Skis, Coolers & More!

MULTI-USE VERSA-CABLE CAMO LOCK

- 9' X 10MM TRIMAFLEX CABLE**
- 9" vinyl coated steel cable (lock not included)
 - Quick installation
 - Ideal for securing and locking: bike racks, jet skis, motorcycles, and furniture
 - Retail packaged
 - 12' and 30' replacement cables sold separately, see below

348040 43.99 9' x 10mm



REPLACEMENT CABLES FOR MULTI-USE CABLE LOCK, SEE ABOVE

- Replacement cable for above multi-use cable lock
- 12' or 30' long x 10mm

TX1012 → 36.99 12' L x 10mm



TX1030 → 49.99 30' L x 10mm



HIGH SECURITY 14MM SHACKLE LOCKS

- High security for your bicycle or ATV
- Mounting bracket included
- Made of high strength hardened steel
- Heavy duty anti-pick lock head
- Includes 3 keys, one equipped with a mini flashlight
- Key hole cover keeps out dirt and grime
- 2 choices
- Retail packaged



TX6010 30.99 4-1/8" x 8" w/14mm shackle



TX6020 29.99 4-1/8" x 11" w/14mm shackle

WEATHER PROOF PADLOCK

- Rugged weather resistant PVC housing covers laminated solid brass lock body
- Dual locking 1-1/8" x 5/16" DIA hardened shackle



TX1125 11.99

KEYED ALIKE LOCKS

- 3 per package keyed alike locks
- Rugged weather resistant PVC housing covers laminated solid brass lock body
- Dual locking 1-1/8" x 5/16" DIA hardened shackle



TX3125 29.99

TRAILER



MAX SECURITY FOR ALL APPLICATIONS!

HIGH SECURITY SHIELDED PADLOCKS

- Ideal for locking enclosed trailers
- Stainless steel, 70mm padlock, 10mm hardened shackle, and exclusive armor plated key core for added security



TX1700 21.99



3 PACK KEYED ALIKE HIGH SECURITY SHIELDED PADLOCKS

- 3 pack keyed alike set of **TX1700** round disc pad lock 70mm

348008 58.99



MAXIMUM SECURITY PADLOCKS IDEAL FOR LOCKING ENCLOSED TRAILERS

51mm hardened solid chrome steel padlock, with 1.25" x 10mm shackle, commercial grade

TX1705 22.99



51mm hardened solid chrome steel padlock, with 2.25" x 10mm shackle, commercial grade and re-keyable

TX2750 22.99



4 PACK KEYED ALIKE LOCKS

- 4-pack keyed alike TX1000 padlocks
- Dual locking laminated padlock
- 40 mm solid steel construction
- 1" x 1/4" diameter shackle

TX4100 29.99



- 4-pack keyed alike TX8700 padlocks
- Marine grade padlock
- Dual locking solid brass body
- Hardened .87" x .25" diameter shackle

348070 46.99



MARINE GRADE PADLOCKS

Rugged dual locking solid brass body with hardened shackle

3/4" x 3/8" DIA Shackle



1.25"

TX7500 18.99

7/8" x 1/4" DIA Shackle



1.5"

TX8700 12.99

1 1/8" x 5/16" DIA Shackle



2.0"

TX1225 21.99

1 3/8" x 3/8" DIA Shackle



2.37"

TX1137 22.99

SHIELDED DOOR LOCKS



- Enlarged opening covers and secures all trailer hasps
- Solid steel thicker body with 3/8" diameter internal shackle

348041 48.99 Each

348042 131.99 3 Pack Keyed Alike

LAMINATED PADLOCKS

Rugged dual locking solid steel laminated padlock with hardened shackle

7/8" x 3/16" DIA Shackle



1.5"

TX8710 9.99

1" x 1/4" DIA Shackle



1.75"

TX1000 10.99

7/16" DIA Shackle



2.0"

TX2150 23.99

5/16" DIA Shackle



2.5"

TX1250 17.99

DOOR HASP



- Epoxy coated steel 2 piece hasp for trailer & shed doors
- Designed to work with the 348041 lock

348043 41.99

HARDENED CHROME STEEL LOCKS

- 64mm solid steel padlock - 1-1/4" x 10mm diameter shackle. Re-keyable.

348068 34.99

- 64mm solid steel padlock - 2-1/4" x 10mm diameter shackle. Re-keyable.

348069 35.99



FAST SAME DAY SHIPPING

tires & wheels
axles, hubs & springs
tongue accessories
hitches
electrical
brake parts
trailer hardware
locks & pins
towing & loading
tie downs
tools
chemicals

TRAILER

LOCKS & PINS

- tires & wheels
- axles, hubs & springs
- tongue accessories
- hitches
- electrical
- brake parts
- trailer hardware
- locks & pins
- towing & loading
- tie downs
- tools
- chemicals



FULTON LOCKS

PART #	MFG #	DESCRIPTION	UM
FT098	19.99 63230	COUPLER LOCK, ADJUSTABLE BRASS	EA
FT100	16.08 63225	TRAILER HITCH LOCK	EA
FT102	56.94 CLK15 0100	CABLE LOCK WITH KEY 15' STEEL CABLE IS COATED WITH DURABLE, FLEXIBLE VINYL THAT PROTECTS AGAINST CORROSION LOCKING MECHANISM IS PRE-LUBRICATED AND COATED WITH A CHIP-RESISTANT FINISH	EA
FT109	35.73 63226	UNIVERSAL TRAILER LOCK	EA
FT114	50.84 63227	COUPLER LOCK 2 5/16" / NEW STYLE	EA
FT115	29.49 32410	RECIEVER LOCK 1/2" DIA PIN	EA
FT116	29.69 32400	RECIEVER LOCK 5/8" DIA PIN	EA
FT119	46.76 ETCHL0700	SPARE TIRE CARRIER WITH LOCK	EA
444000	56.95 TP20A1534	KEYED ALIKE 2" COUPLER LOCK	EA
444001	30.21 STL 0603	SPARE TIRE LOCK FITS OVER WHEEL STUDS UP TO 9/16" DIAMETER REMOVABLE PLUG ALLOWS FOR LONGER WHEEL STUDS LOCKING TAB PROVIDES POSITIVE LOCKING FEATURE TO PREVENT LOCK FROM TURNING	EA
444002	55.09 OML 0127	OUTBOARD MOTOR LOCK MOUNTS ON MOST OUTBOARD MOTORS FOAM INSERT REDUCES NOISE AND VIBRATION LOCK COVER KEEPS MOISTURE TO A MINIMUM. SHIPS WITH TWO KEYS	EA



FT115



FT102



FT119



FT100

TRAILER



BUYERS LOCKS



BY253



BY5000

PART #	MFG #	DESCRIPTION	UM
BY5000	7.60 BCL500	COUPLER LATCH LOCK 1/4" PIN 3/4" ADJUSTABLE TRAVEL	EA
BY253	31.48 BDL253	DRAWBAR LOCK FITS ALL 2-1/2" - 3" LUNETTE EYES PADLOCK NOT INCLUDED	EA
BY125	16.66 BLHP125	LOCKING HITCH PIN FOR 1-1/4" RECEIVERS 1-2" DIAMETER	EA
BY7200	16.48 BLHP200	LOCKING HITCH PIN FOR 2" RECEIVERS 5/8" DIAMETER	EA
BY300	23.56 BLHP300	LOCKING HITCH PIN FOR 2" RECEIVERS BONE STYLE 5/8" DIAMETER	EA



BY125

DEAD-BOLT LOCKS



PART #	MFG #	DESCRIPTION	UM
CT32	89.95	UTK-32	EA
		ULTIMATE TOW KIT. LOCK YOUR HITCH, TRAILER, AND CARGO WITH ONE KEY HITCH LOCK 5/8" DIAMETER FITS 2X2 RECEIVER STYLE HITCHES MAX TORQUE 600 LBS. MAX TRAILER WEIGHT 6000LBS. KIT INCLUDES 2" BALL AND MOUNT CLASS 3,4 HITCH LOCK TRAILER COUPLER LOCK AND A 10' CABLE LOCK	



- tires & wheels
- axles, hubs & springs
- tongue accessories
- hitches
- electrical
- brake parts
- trailer hardware
- locks & pins**
- towing & loading
- tie downs
- tools
- chemicals

BULLDOG LOCKS



PART #	MFG #	DESCRIPTION	UM
444016	26.46	580400	EA
		5/8" CHROME BENT PIN LOCK.	
444017	27.50	580401	EA
		5/8" CHROME DOGBONE LOCK.	
444018	32.18	580403	EA
		CHROME COUPLER LOCK.	
444019	54.47	580404	EA
		5/8" CHROME DOGBONE LOCK W/ CHROME COUPLER LOCK	
444020	24.66	580408	EA
		STAINLESS STEEL COUPLER LOCK	
444021	60.68	580406	EA
		LOCK 5/8" HITCH PIN COUPLER LOCK COMBO STAINLESS STEEL	
444022	44.60	580402	EA
		5/8" STAINLESS STEEL DOGBONE LOCK	
444081	39.95	580405	EA
		STAINLESS STEEL DOGBONE LOCK W/SLEEVE FOR 1-1/4" & 2" SQUARE RECIEVERS	
444082	21.78	580407	EA
		EASY ACCESS LOCK W/SLEEVE FOR 1-1/4" & 2" SQUARE RECEIVERS	
444083	23.44	580409	EA
		EASY ACCESS LONG COUPLER LOCK	
444084	28.53	580410	EA
		EASY ACCESS ADJUSTABLE COUPLER LOCK	

TRAILER

LOCKS & PINS

- tires & wheels
- axles, hubs & springs
- tongue accessories
- hitches
- electrical
- brake parts
- trailer hardware
- locks & pins**
- towing & loading
- tie downs
- tools
- chemicals

TRAILER

TOW READY LOCKS



PART #	MFG #	DESCRIPTION	UM
444004	21.78 63248	RECEIVER LOCK, BARREL STYLE W/BENT PINS, 1/2" FOR 1-1/4" SQ. RECEIVERS & 5/8" FOR 2" SQ. RECEIVERS. CAN ACCOMMODATE CLASS I, II, III, IV OR V HITCHES. SOLID STAINLESS STEEL PIN FITS CROSSWISE INTO THE HOLE ON YOUR RECEIVER WITH A DEADBOLT SECURING IT IN PLACE.	EA
444005	19.71 63224	RECEIVER LOCK, BENT PIN, 1/2" FOR 1-1/4" SQ. RECEIVERS & FIFTH WHEEL BASE RAILS. CAN ACCOMMODATE CLASS I, II, III, IV OR V HITCHES. SOLID STAINLESS STEEL PIN FITS CROSSWISE INTO THE HOLE ON YOUR RECEIVER WITH A DEADBOLT SECURING IT IN PLACE.	EA
444006	20.01 63223	RECEIVER LOCK, BENT PIN, 5/8" FOR 2" & 2-1/2" SQ. RECEIVERS. CAN ACCOMMODATE CLASS I, II, III, IV OR V HITCHES. SOLID STAINLESS STEEL PIN FITS CROSSWISE INTO THE HOLE ON YOUR RECEIVER WITH A DEADBOLT SECURING IT IN PLACE.	EA
444007	28.20 63252	RECEIVER LOCK, DOGBONE STYLE, 5/8" FOR 2-1/2" SQ. RECEIVERS, 3-1/2" SPAN. CAN ACCOMMODATE CLASS I, II, III, IV OR V HITCHES. SOLID STAINLESS STEEL PIN FITS CROSSWISE INTO THE HOLE ON YOUR RECEIVER WITH A DEADBOLT SECURING IT IN PLACE.	EA
444008	27.16 63253	RECEIVER LOCK, BARREL STYLE W/BENT PIN, 5/8" FOR 2-1/2" SQ. RECEIVERS, 3-1/2" SPAN. CAN ACCOMMODATE CLASS I, II, III, IV OR V HITCHES. SOLID STAINLESS STEEL PIN FITS CROSSWISE INTO THE HOLE ON YOUR RECEIVER WITH A DEADBOLT SECURING IT IN PLACE.	EA
444009	30.28 63216KA	RECEIVER LOCK, DEAD BOLT, 1/2" FOR 1-1/4" SQ. RECEIVERS, BLACK FINISH (KEYED ALIKE BULK)	EA
444010	37.04 63217KA	RECEIVER LOCK, DEAD BOLT, 5/8" FOR 2" SQ. RECEIVERS, BLACK FINISH (KEYED ALIKE BULK)	EA
444011	73.33 63218KA	COMBO LOCK SET, 1/2" DEAD BOLT FOR 1-1/4" SQ. RECEIVER AND TRAILER COUPLER 1/2" SPAN, BLACK FINISH (KEYED ALIKE BULK)	SET
444015	28.05 63222KA	COUPLER LOCK, DEAD BOLT SURGE BRAKE, 2-3/8" SPAN, BLACK FINISH (KEYED ALIKE BULK)	EA
444086	40.97 63250	COMBO LOCK SET, DOGBONE STYLE, 1/2" FOR 1-1/4" SQ. RECEIVERS, 5/8" FOR 2" SQ. RECEIVERS W/UNIVERSAL STAINLESS STEEL SLEEVE & COUPLER LOCK	EA
444087	79.54 63256	RECEIVER LOCK FITS: 1-1/4" & 2" RECEIVERS. KEYED ALIKE CONVENIENCE. INCLUDES: 1 UNIVERSAL COUPLER LOCK, 1 DUAL BENT PIN RECEIVER LOCK AND 1 ADJUSTABLE COUPLER LOCK. GUARDS AGAINST TOWED AND PARKED TRAILER THEFTS. INCLUDES THREE INTERCHANGEABLE KEYS	EA
444088	56.34 63219KA	COMBO LOCK SET, 5/8" DEAD BOLT FOR 2" SQ. RECEIVER AND TRAILER COUPLER 1/2" SPAN, BLACK FINISH (KEYED ALIKE) (ORDER IN 3 PACK MULTIPLES ONLY)	EA
444089	32.99 63233	CABLE LOCK, 5/16" X 10' LENGTH	EA
444090	19.12 63255	CABLE LOCK, 5/16" X 4' LENGTH	EA



BUYERS COUPLER SAFETY PINS

Buyers coupler pins are available in bulk or in display packages. The display packages are packed two per package available square loop only. Yellow zinc plated.

PART #	MFG #	A DIA WIDTH	B USABLE LENGTH	C LOOP CLEARANCE	D PIN LENGTH	STYLE	UM
BY6050	1.02 66050	1/4"	1-13/16"	1-1/2"	2"	SQUARE	EA
BY6063	0.90 66063	1/4"	2-1/2"	2-1/2"	2-49/64"	SQUARE	EA
BY6064	2.02 66064	1/4"	2-1/2"	2-1/2"	2-49/64"	SQUARE	PKG 2
BY6066	0.90 66066	1/4"	3"	1-1/2"	3-1/4"	SQUARE	EA
BY6067	2.02 66067	1/4"	3"	1-1/2"	3-1/4"	SQUARE	PKG 2
BY6070	0.92 66070	1/4"	3-5/8"	1-1/2"	3-3/4"	SQUARE	EA
BY6053	0.90 66053	5/16"	1-5/8"	2-19/32"	2-25/32"	SQUARE	EA
BY6054	1.95 66054	5/16"	1-5/8"	2-19/32"	2-25/32"	SQUARE	PKG 2
BY6056	1.00 66056	3/8"	1-17/32"	1-17/32"	1-5/8"	SQUARE	EA
BY6060	1.00 66060	3/8"	2-11/32"	2-11/32"	2-1/2"	SQUARE	EA
BY6061	2.15 66061	3/8"	2-11/32"	2-11/32"	2-1/2"	SQUARE	PKG 2

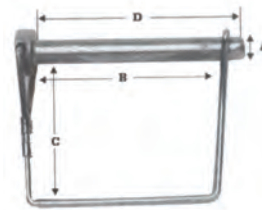

PIVOT POINT

PIVOT POINT COUPLER PINS

Safety lock pins have pin and cotter all in one assembly. The wire loop is pulled over the pin end to lock it in place or remove it. Quick connect or disconnect prevents coupler latch from accidentally opening. Tempered spring with carbon steel pin zinc plated.

PART #	MFG #	A DIA WIDTH	B USABLE LENGTH	C LOOP CLEARANCE	D PIN LENGTH	STYLE	UM
PT110	1.95 WIRE-1RD	1/4"	1-3/4"	1-1/2"	2"	ROUND	EA
PT115	2.95 WIRE-3RD	5/16"	2-5/16"	2"	2-3/4"	ROUND	EA
PT101	1.95 WIRE-3SQ	5/16"	2-3/8"	1-3/4"	2-3/4"	SQUARE	EA
PT107	1.95 WIRE-7SQ	3/8"	2-1/8"	1-1/2"	2-1/2"	SQUARE	EA



PIVOT POINT

BUYERS LYNCH PINS

PART #	MFG #	A DIA WIDTH	B USABLE LENGTH	C LOOP WIDTH	D PIN LENGTH	STYLE	UM
BY6003	0.55 66003	3/16"	1-1/8"	1-5/16"	1-7/16"	FLAT ROUND	EA
BY6000	0.48 66000	1/4"	1-1/2"	1-11/16"	1-3/4"	FLAT ROUND	EA
BY6006	0.55 66006	5/16"	1-1/2"	1-3/4"	1-3/4"	FLAT ROUND	EA
BY6010	0.64 66010	7/16"	1-1/2"	1-3/4"	1-3/4"	FLAT ROUND	EA
BY6015	0.88 66015	7/16"	1-1/2"	1-3/4"	1-15/16"	FLAT ROUND	EA

PIVOT POINT LYNCH PINS

PART #	MFG #	A DIA WIDTH	B USABLE LENGTH	C LOOP WIDTH	D PIN LENGTH	STYLE	UM
PT226	1.40 HANG-2	3/16"	1-1/4"	1-7/16"	1-1/2"	FLAT ROUND	EA
PT224	1.95 HANG-4	1/4"	1-1/2"	1-11/16"	1-3/4"	FLAT ROUND	EA
PT225	1.75 HANG-6	5/16"	1-5/16"	1-1/2"	1-3/4"	FLAT ROUND	EA



BUYERS HITCH PINS

PART #	MFG #	A DIA WIDTH	B USABLE LENGTH	C HAIR PIN WIDTH	D PIN LENGTH	STYLE	UM
BY6100	2.40 66100	1/2"	4-3/8"	PT027	4-15/16"	LOOP END	EA
BY6105	4.18 66105	5/8"	6-5/16"	PT027	6-15/16"	LOOP END	EA
BY6110	3.75 66110	3/4"	4-7/16"	PT029	4-15/16"	LOOP END	EA
BY6115	4.50 66115	3/4"	6-1/4"	PT029	7"	LOOP END	EA
BY6120	5.40 66120	7/8"	6-5/16"	PT029	6-15/16"	LOOP END	EA
BY6125	6.95 66125	1"	6-1/4"	PT029	6-3/4"	LOOP END	EA

- tires & wheels
- axles, hubs & springs
- tongue accessories
- hitches
- electrical
- brake parts
- trailer hardware
- locks & pins
- towing & loading
- tie downs
- tools
- chemicals

TRAILER

LOCKS & PINS

- tires & wheels
- axles, hubs & springs
- tongue accessories
- hitches
- electrical
- brake parts
- trailer hardware
- locks & pins
- towing & loading
- tie downs
- tools
- chemicals

TRAILER

BUYERS HITCH PINS POWDER COATED

PART #	MFG #	A DIA WIDTH	B USABLE LENGTH	HAIR PIN	D PIN LENGTH	STYLE	UM
BY6101	4.90	66101	1/2"	3-1/2"	PT027	4-1/8"	LOOP END EA
BY6107	6.05	66107	5/8"	3-3/4"	PT027	4-1/4"	LOOP END EA
BY6111	7.10	66111	3/4"	3-3/4"	PT029	4"	LOOP END EA



BUYERS BENT HITCH PINS

PART #	MFG #	A DIA WIDTH	B USABLE LENGTH	HAIR PIN	D PIN LENGTH	STYLE	UM
BY190	2.48		1/2"	3-1/4"	PT026	5-1/2"	BENT EA
BY200	3.42		5/8"	3-1/16"	PT028	5-1/4"	BENT EA



TRIMAX BENT HITCH PINS

1/2" PIN FITS CLASS I, II RECEIVERS. 5/8" PIN FIT ALL CLASS III, IV, V RECEIVERS

PART #	MFG #	A DIA WIDTH	B USABLE LENGTH	HAIR PIN	D PIN LENGTH	STYLE	UM
TX1258	9.99	SP125	1/2"	2-1/2"	PT028	3-1/2"	BENT EA
TX2010	10.99	SP200	5/8"	3-1/2"	PT028	5-3/4"	BENT EA



PIVOT POINT HAIR PINS

PART #	MFG#	DIA WIDTH	PIN LENGTH	UM	
PT024	0.15	HAIR-4	1/16"	1-3/8"	EA
PT025	0.20	HAIR-5	3/32"	1-5/8"	EA
PT026	0.25	HAIR-6	3/32"	2"	EA
PT027	0.30	HAIR-8	1/8"	2-3/8"	EA
PT028	0.55	HAIR-10	5/32"	2-7/8"	EA
PT029	0.60	HAIR-12	3/6"	3-1/4"	EA

PIVOT POINT



BUYERS BENT SWIVEL HITCH PIN

FEATURES A FLIP TIP NO HAIR PINS REQUIRED.

PART #	MFG #	A DIA WIDTH	B USABLE LENGTH	SWIVEL PIN	D PIN LENGTH	STYLE	UM
BY625	6.40	HP625SC	5/8"	2-3/4"	1-3/4"	5"	BENT FLIP TIP EA



TRIMAX BENT FLIP TIP HITCH PIN

FEATURES A FLIP TIP NO HAIR PINS REQUIRED.

PART #	MFG #	A DIA WIDTH	B USABLE LENGTH	SWIVEL PIN	D PIN LENGTH	STYLE	UM
TX1255	17.99	SXTX125	1/2"	2-1/2"	1-3/4"	4-3/4"	BENT FLIP TIP EA
TX2005	17.99	SXTX200	5/8"	3-11/16"	1-3/4"	5-1/4"	BENT FLIP TIP EA



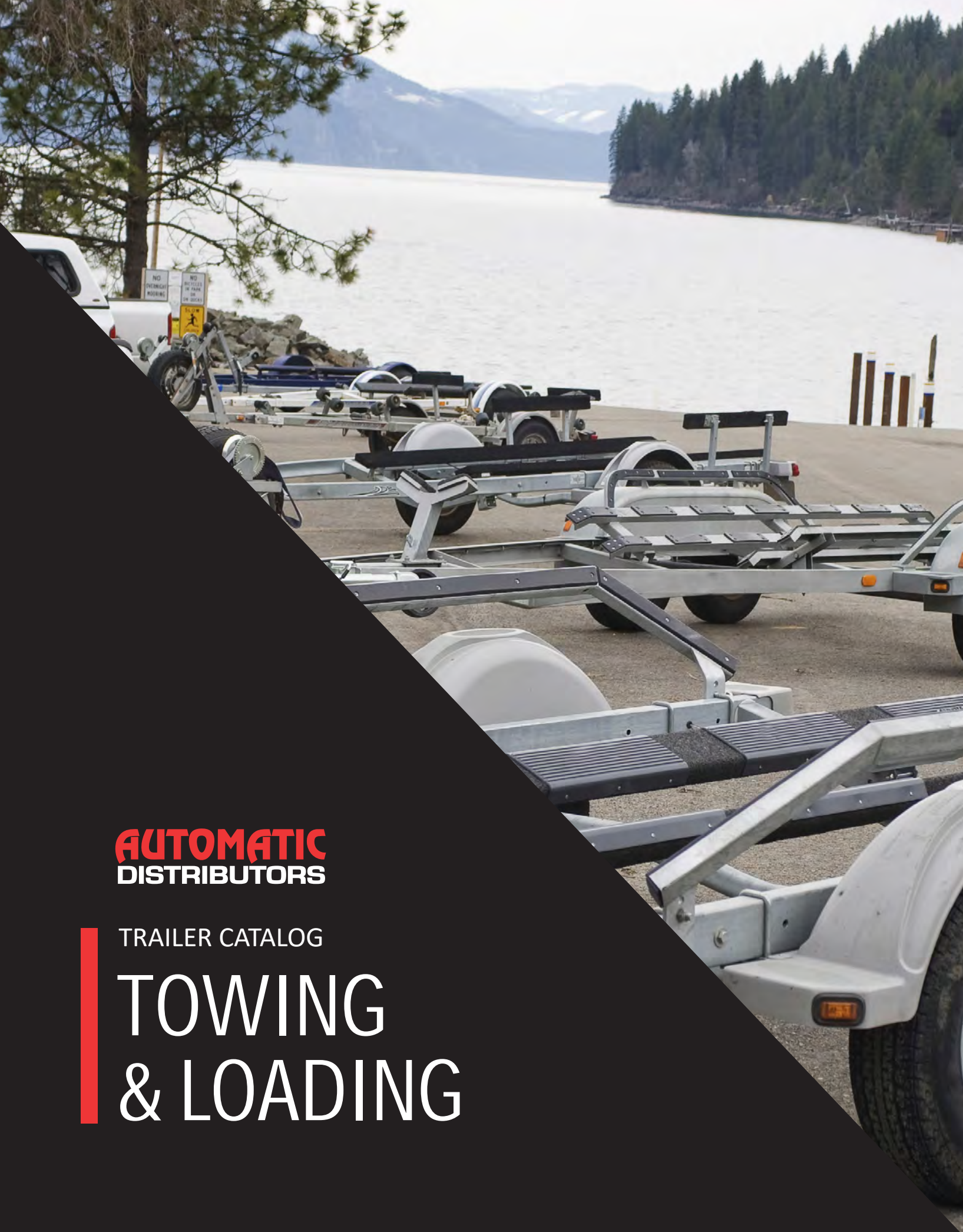

AUTOMATIC
DISTRIBUTORS

TRAILER CATALOG

**TOWING
& LOADING**

TOWING & LOADING

CIPA CUSTOM TOW MIRRORS

CIPA's Custom Towing Mirrors slide over your existing mirrors to give you added towing vision. No tools required, leaves no marks or holes on your vehicle. Custom Towing Mirrors are designed to fit the applications listed below. Other fits may vary due to color, material, added features or adjustment variations.



- tires & wheels
- axles, hubs & springs
- tongue accessories
- hitches
- electrical
- brake parts
- trailer hardware
- locks & pins
- towing & loading
- tie downs
- tools
- chemicals

TRAILER

FITS	PART #	YEAR	APPLICATIONS	EXCEPTIONS/INFO
Pair	530000 38.95	86-95	Dodge pickups and Vans	*86-93 fits both electric & manual chrome mirrors *94-95 Fits manual chrome mirrors only
Pair	530001 38.95	94-97	Dodge pickups and Vans	*94-97 fits both electric & manual black mirrors *96-97 fits electric chrome mirrors * Will not fit Dakotas with black sporty mirrors
Pair	530002 76.95	94-02	Dodge old style 1500, 2500, 3500	
Driver	530003 40.95	98-03	Dodge Durango	* Will not fit 5x7 Sport style mirrors
Passenger	530004 40.95	98-04	Dodge Dakota	
		00-03	Dodge full size Van	
Pair	530005 85.95			
Driver	530006 42.95	02-08	Dodge Ram 1500	*Does not fit Extendable mirrors on the 3500 models
Passenger	530007 42.95	03-08	Dodge Ram 2500, 3500	
Pair	530008 89.95			
Driver	530009 45.95	09-16	Dodge Ram 1500	*Does not fit Extendable mirrors on the 2500 models
Passenger	530010 45.95	09-16	Dodge Ram 2500	
Pair	530011 38.95	83-98	Ford full size pickups	*Fits the chrome door mount break away style mirror only
		83-91	Ford Ranger	
Pair	530012 80.95	92-97	Ford full size pickups	
Driver	530013 40.95	90-97	Ford Aerostar	*Fits Black, or black with chrome cap mirrors
Passenger	530014 40.95	92-96	Ford Bronco	
		1997	Ford F-250 & F-350 HD w/old body	
Pair	530015 80.95	97-04	Ford F-150, F-250 Light Duty	*Fits Contour style mirror only, Will not fit mirrors w/signal, or STX style mirrors
Driver	530016 39.91	97-02	Ford Expedition	
Passenger	530017 39.91	97-02	Lincoln Navigator	*Will not fit 2004 pickups with new body style See 11800
Pair	530018 89.95			
Driver	530019 45.95	04-14	Ford F-150, F-250 Light Duty	*Will not fit STX style mirrors
Passenger	530020 45.95	04-14	Ford F-150, F-250 XLT Models	* Will not fit Super Duty
Pair	530067 89.95	15-19	Ford F-150	
Driver	530065 45.95	15-19	Ford F-151	
Passenger	530066 45.95	15-19	Ford F-152	
Pair	530021 85.95			
Driver	530022 37.99	97-08	Ford F-250, F-350 Super Duty	
Passenger	530023 42.95	00-08	Ford Excursion	
Pair	530024 117.95			
Driver	530025 58.95	07-14	Toyota Tundra	
Passenger	530026 58.95	07-14	Toyota Sequoia	* Will not fit Sequoia Limited or Platinum Editions
Pair	530000 38.95	80-95	Chevy/GMC pickups & Vans	*Fits manual chrome mirrors only *Will not fit the chrome mirrors with black trim
Pair	530011 38.95	82-93	Chevy S-10, S-15	*Fits the chrome door-mount two point break-away style mirror only
Pair	530027 76.95	88-00	Chevy/GMC Full-size C/K Pickups	
Driver	530028 38.95	92-99	Chevy/GMC Suburban, Yukon, Kodiak	
Passenger	530029 38.95	92-99	Chevy Tahoe, Dually	
		91-04	Chevy/GMC Safari, Astro	
		92-99	Cadillac Escalade	
Driver	530031 29.95	97-04	GMC Sillhouette	
Pair	530033 85.95	99-07	Chevy/GMC Silverado, Sierra	*Fits Black capped and chrome capped models
Driver	530034 42.95	00-07	Chevy Tahoe, Suburban	*will not fit Full-Chrome mirrors
Passenger	530035 42.95	00-07	Chevy Avalanche	*Will not fit Telescopic mirrors
		00-07	GMC Denali, Yukon, Yukon XL	
		00-07	Cadillac Escalade	
Pair	530036 89.95	07-13	Chevy/GMC Silverado, Sierra	
Driver	530037 45.95	07-13	Chevy Tahoe, Suburban	
Passenger	530038 45.95	07-13	Chevy Avalanche	*Will not fit Telescopic mirrors
		07-13	GMC Denali, Yukon, Yukon XL	
		07-13	Cadillac Escalade	
Pair	530062 89.95	14-18	chevy/GMC Silverado, Sierra	
Driver	530063 45.95			
Passenger	530064 45.95			





CIPA CUSTOM TOWING MIRROR REPLACEMENT HARDWARE

Lost a knob, misplaced a wedge? CIPA offers a complete line of replacement hardware.

DESCRIPTION	PART #	
VISION 180 MIRROR WITH DELUXE CAST ALUMINUM MOUNTING BRACKET	530042	248.95
COMP UNIVERSAL MIRROR WITH DELUXE CAST ALUMINUM MOUNTING BRACKET	530045	207.95
CONCEPT II MIRROR WITH HIGH STRENGTH COMPOSITE BRACKET	530047	53.95
COMP II MIRROR WITH HIGH STRENGTH COMPOSITE BRACKET	530048	60.95
ELLIPSE MIRROR WITH HIGH STRENGTH COMPOSITE BRACKET	530049	64.95
PWC SPORT MIRRORS - BLACK	530051	26.95
PWC SPORT II - BLACK	530052	32.95
HAND MIRROR	530053	7.99
CLEAR SAFE-T-CLEAT	530054	45.95
WHITE SAFE-T-CLEAT	530056	45.95
BLACK RETRACTABLE DOCK CLEAT	530057	29.95
WHITE RETRACTABLE DOCK CLEAT	530058	29.95
ECONOMY MARINE MIRROR	530059	19.99
SUCTION CUP MIRROR	530060	24.95
BOATING SAFETY MIRROR	530061	29.95

CIPA UNIVERSAL CLIP ON MIRRORS

CLIP ON TOWING MIRROR ▶

CIPA's Clip-On Towing Mirror was designed to fit large factory truck and van mirrors. Rubber straps secure the Clip-On Towing Mirror to your vehicle's existing mirror, and easy-to-adjust arms fit tightly for a steady vibration-free ride. The Clip-On Towing Mirror extends your vision further than any OE mirror ever could with a total extension of 7 inches. This mirror will not obstruct your vehicle's existing viewing area. The Clip-On Towing Mirror has a 5" by 7.5" mirror face that widens visibility, in addition to your factory mirror, for peace of mind while towing. It will fit up to a 10" mirror. The Clip-On Towing Mirror is not position specific, so it can accommodate the driver side or the passenger side of your vehicle. Installation is simple and no tools are required. The Clip-On Towing Mirror is perfect for temporary or light towing needs. It is not recommended to be used as a full time heavy-duty towing solution. For best results, remove the towing mirror when not in use, and store in a cool dry place. Expand your Horizons.

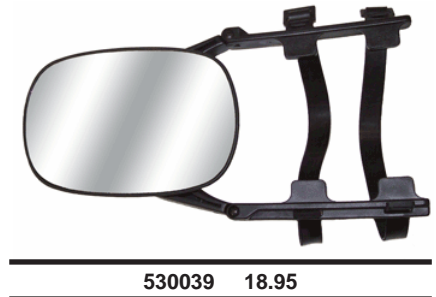

530039 18.95

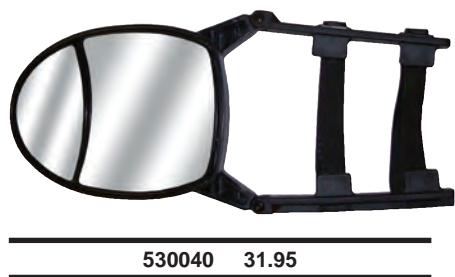

530040 31.95

◀ DUAL VIEW CLIP ON TOWING MIRROR

The Dual-view Clip-On Towing Mirror provides better towing vision than any towing mirror out there! This innovative product features two fully adjustable mirror surfaces that allow you to fully customize your viewing area. The Dual-view Clip-on's large, flat mirror surface gives an accurate perspective of what is behind you, while the smaller convex surface acts as a built-in spot mirror for increased safety while driving, passing or changing lanes. Plus the fully enclosed mirror head design not only reduces wind vibration, but also ensures that the Dual-View's adjustable mirror surfaces stay right where you put them. This universal mirror features two adjustable arms and rubber straps that will not obstruct your existing mirror. Fits most 7" to 10" mirrors. Expand your Horizons.

UNIVERSAL TOWING MIRROR ▶

CIPA's Universal Towing Mirror is the mirror that you have been looking for! This member of CIPA's towing line is designed to fit the majority of vehicles, and reduce vibration, while maintaining a clean aerodynamic look on your existing mirror. This towing mirror is sure to surpass your expectations in all situations! The Universal Towing Mirror will provide enhanced safety while towing by extending your vision by a full 5 inches. This mirror features a 5 inch by 4.5 inch mirror face, and will not obstruct the view from your original factory mirror. The moveable feet, sturdy clamps, and tightening knob give you a secure fit without annoying vibration. This mirror's aerodynamic styling compliments virtually any vehicle. The Universal Towing Mirror accommodates the driver side or passenger side of your vehicle. Expand your Horizons.



530041 50.95

- tires & wheels
- axles, hubs & springs
- tongue accessories
- hitches
- electrical
- brake parts
- trailer hardware
- locks & pins
- towing & loading
- tie downs
- tools
- chemicals

TRAILER

TOWING & LOADING

- tires & wheels
- axles, hubs & springs
- tongue accessories
- hitches
- electrical
- brake parts
- trailer hardware
- locks & pins
- towing & loading
- tie downs
- tools
- chemicals

6' ALUMINUM BI-FOLDING RAMP

- Welded aluminum construction
- Lightweight with rubber-coated tips
- 1200 lb. distributed weight capacity
- Heavy duty security straps included
- Rust and corrosion resistant
- 48" wide x 72" long

MFG #	SIZE	PART #	
AR16	6' x 48"	532000	199.95



6' ALUMINUM BI-FOLDING RAMP

- Welded aluminum construction
- Lightweight with rubber-coated tips
- 1200 lb. distributed weight capacity
- Heavy duty security straps included
- Rust and corrosion resistant
- 48" wide x 72" long

MFG #	SIZE	PART #	
R001XW	6' x 48"	24-001	199.95



7' ALUMINUM ARCHED RAMP

- Welded aluminum construction
- Lightweight with rubber-coated tips
- 1000 lb. distributed weight capacity
- Heavy duty security straps included
- Rust and corrosion resistant
- Each ramp is 12" wide x 88" long

MFG #	SIZE	PART #	
R004M	12' x 88"	24-004	219.95



6' ALUMINUM TRI-FOLD ARCHED RAMP

- Welded aluminum construction
- Lightweight with rubber-coated tips
- 1200 lb. distributed weight capacity
- Heavy duty security straps included
- Rust and corrosion resistant
- 48" wide x 72" long

MFG #	SIZE	PART #	
AR04T	6' x 48"	532001	219.95



TRAILER

HEAVY DUTY LIFT ARM

- Unaffected by temperature
- Zinc electro-plated steel
- 16 gauge steel tubing
- Stronger, lifts more weight
- No seals to deteriorate
- Specially treated shot-peened high tensile spring mechanism lasts for years

PART #	MFG #	
CM68	PA-CNRMPG8	119.95



2-PACK BOXED RAMP KIT

- Kit includes: carriage bolts, nuts, and washers
- (2) 750 lb. ramp plates (1/4")



PART #	MFG #	
EK7400	07400	89.95

RAMP PLATES

- Our aluminum loading ramp plate can quickly convert a 2" x 8" board into a quick and very inexpensive loading ramp to load your atv, motorcycle, lawn mower, etc. into your pickup or on a trailer
- Available in 2 sizes - Sold Each



PART #	MFG #	SIZE	WEIGHT	
EK7200	07200	1/4"	750#	34.95



MARINE SLIDES TRAILER BUNK SLIDES

Makes launching your boat or watercraft easy, slides effortlessly off bunks and into the water.

- The new unique profile provides extra cushioning between the boat and trailer bunks
- Washout channels flush sand and debris off of the slides and away from the hull
- Safer unloading and loading because of reduced friction and stress by 400% on the trailer cranking mechanisms, ropes and hull bow hooks
- Allows you to unload and load your boat or watercraft in shallower water
- Fast and simple installation for both horizontal and vertical bunks
- Made from a low-friction composite which is impervious to sun, weather and salt water
- Excellent for use on work stations, lifts, boat and watercraft dollies

MFG #	DESCRIPTION	PART#	
23010	10 Pack - 3" x 15" Black	PD23010	39.95
23011	10 Pack - 3" x 15" White	PD23011	39.95
23013	10 Pack - 3" x 15" Yellow	362015	39.95
23030	10 Pack - 1.5" x 15" Black	362016	29.95
23031	10 Pack - 1.5" x 15" White	362017	29.95
23033	10 Pack - 1.5" x 15" Yellow	362018	29.95

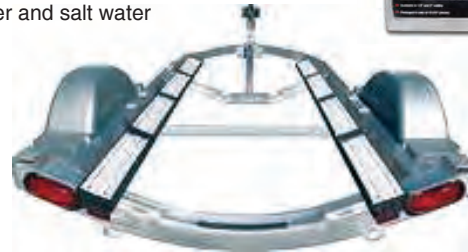

BUNK WRAP II RETAIL TRAILER BUNK WRAPS

Renew Your Old Shaggy Carpeted Bunks with a Permanent Solution!

- Reduce the spread of invasive species.
- Eliminate electrolysis breakdown on aluminum.
- Wraps directly over bare wood!
- Slot fastening for wrinkle-free temp adjustment.
- Great for trailers and boat lifts!
- Made with proprietary High-Impact Glide Guard technology plastic.
- Material will not wear, crack, chip or fade.
- This is a permanent solution, GUARANTEED FOR LIFE!



2"x6"
Black-or-Grey
16' or 24' roll

2"x4"
Black-or-Grey
16' or 24' roll



MFG #	DESCRIPTION	PART #	
16 FOOT ROLL			
23050	2x4 Gray on 16' Roll w/4 Endcaps & Stainless Hardware	362011	59.95
23052	2x6 Gray on 16' Roll w/4 Endcaps & Stainless Hardware	362013	74.95
23050-BK	2x4 Black on 16' Roll w/4 Endcaps & Stainless Hardware	362012	59.95
23052-BK	2x6 Black on 16' Roll w/4 Endcaps & Stainless Hardware	362014	74.95
24 FOOT ROLL			
23054	2x4 Gray on 24' Roll w/4 Endcaps & Stainless Hardware	362049	74.95
23054-BK	2x4 Black on 24' Roll w/4 Endcaps & Stainless Hardware	362050	74.95
23056	2x6 Gray on 24' Roll w/4 Endcaps & Stainless Hardware	362051	94.95
23056-BK	2x6 Black on 24' Roll w/4 Endcaps & Stainless Hardware	362052	94.95



FAST SAME DAY SHIPPING

TRAILER CATALOG

tires & wheels

axles, hubs & springs

tongue accessories

hitches

electrical

brake parts

trailer hardware

locks & pins

towing & loading

tie downs

tools

chemicals

TRAILER

TOWING & LOADING



BULK BUNK WRAP ROLLS AND END CAP HARDWARE

Renew Your Old Shaggy Carpeted Bunks with a Permanent Solution!

- Less strain on arms, ropes, pulleys, and bow eyes
- Helps reduce the spread of invasive species
- Bunk Wrap mounts directly over bare wood
- Eliminate Electrolysis breakdown of Aluminum
- Great for Boat, Pontoon, and PWC, Lifts and Trailer
- NOT to be installed over carpet

MFG #	DESCRIPTION	PART #	
250 FOOT BULK ROLL			
23068	2x4 Gray 250' Bulk Roll	362082	794.95
23068-BK	2x4 Black 250' Bulk Roll	362083	794.95
23070	2x6 Gray 250' Bulk Roll	362084	995.95
23070-BK	2x6 Black 250' Bulk Roll	362085	995.95
END CAPS & HARDWARE			
23072	BUNKWRAP ENDCAPS 2X4" - GREY (24CT. BOX)	362086	34.95
23072-BK	BUNKWRAP ENDCAPS 2X4" - BLACK (24CT. BOX)	362087	34.95
23074	BUNKWRAP ENDCAPS 2X6" - GREY (24CT. BOX)	362088	39.95
23074-BK	BUNKWRAP ENDCAPS 2X6" - BLACK (24CT. BOX)	362089	39.95

NEW



tires & wheels
axles, hubs & springs
tongue accessories
hitches
electrical
brake parts
trailer hardware
locks & pins
towing & loading
tie downs
tools
chemicals



SPRAY-ON BUNK LUBRICANT

Makes launching your boat or watercraft easy, slides effortlessly off bunks and into the water.

- Reduces cranking torque required by as much as 275%
- Safer unloading and loading by dramatically reducing stress on the trailer crank mechanisms, ropes and hull bow hooks
- Allows you to unload and load your boat or watercraft in shallower water
- Fast and simple application for both horizontal and vertical bunks
- Made from a unique blend of anti-friction compounds
- Excellent for use on work stations, boat lifts and watercraft dollies
- Comes in 1 pint (16 fl. oz.) easy-to-use spray bottle and is applied directly to carpeted bunks

MFG #	DESCRIPTION	PART #	
23200	16 fl. oz. Spray Bottle	PD23200	18.95



LOADING MADE EASIER!



- Increased size allowing for more versatility
- Integrated traction knobs to provide grip for tires and foot traffic
- Integrated cut lines to provide clear edges when trimming to fit
- Easily transition onto trailer doors and across door gaps.
- Saves door edges from damage from the ski carbides.
- Modified high density polymer is guaranteed not to crack.
- Can be fastened in a fixed position for tilt trailers.
- Includes stainless steel mounting hardware.
- Made in the U.S.A. comes with a Lifetime warranty.



PART #	MFG #	DESCRIPTION
362054	64.95 13390	Edge Glide 2.0 2pc (48")
362055	84.95 13391	Edge Glide 2.0 3pc (72")
362056	104.95 13392	Edge Glide 2.0 4pc (96")

PRODUCT DIMENSIONS:
2pc (48"), 3pc (72") or 4pc (96")
INCLUDES: Instructions and stainless steel hardware

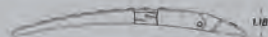

INCHES	MILLIMETERS
1/8"	3.175
1/4"	6.350
3/8"	9.525
1/2"	12.700
5/8"	15.875
3/4"	19.050
7/8"	22.225
1"	25.400
1 1/8"	28.575
1 1/4"	31.750
1 3/8"	34.925
1 1/2"	38.100
1 5/8"	41.275
1 3/4"	44.450
1 7/8"	47.625
2"	50.800
2 1/8"	53.975
2 1/4"	57.150
2 3/8"	60.325
2 1/2"	63.500
2 5/8"	66.675
2 3/4"	69.850
2 7/8"	73.025
3"	76.200
3 1/8"	79.375
3 1/4"	82.550
3 3/8"	85.725
3 1/2"	88.900
3 5/8"	92.075
3 3/4"	95.250
3 7/8"	98.425
4"	101.600
4 1/8"	104.775
4 1/4"	107.950
4 3/8"	111.125
4 1/2"	114.300
4 5/8"	117.475
4 3/4"	120.650
4 7/8"	123.825
5"	127.000
5 1/8"	130.175
5 1/4"	133.350
5 3/8"	136.525
5 1/2"	139.700
5 5/8"	142.875
5 3/4"	146.050
5 7/8"	149.225
6"	152.400
6 1/8"	155.575
6 1/4"	158.750
6 3/8"	161.925
6 1/2"	165.100
6 5/8"	168.275
6 3/4"	171.450
6 7/8"	174.625
7"	177.800
7 1/8"	180.975
7 1/4"	184.150
7 3/8"	187.325
7 1/2"	190.500
7 5/8"	193.675
7 3/4"	196.850
7 7/8"	199.925
8"	203.100
8 1/8"	206.275
8 1/4"	209.450
8 3/8"	212.625
8 1/2"	215.800
8 5/8"	218.975
8 3/4"	222.150
8 7/8"	225.325
9"	228.500
9 1/8"	231.675
9 1/4"	234.850
9 3/8"	238.025
9 1/2"	241.200
9 5/8"	244.375
9 3/4"	247.550
9 7/8"	250.725
10"	253.900
10 1/8"	257.075
10 1/4"	260.250
10 3/8"	263.425
10 1/2"	266.600
10 5/8"	269.775
10 3/4"	272.950
10 7/8"	276.125
11"	279.300
11 1/8"	282.475
11 1/4"	285.650
11 3/8"	288.825
11 1/2"	292.000
11 5/8"	295.175
11 3/4"	298.350
11 7/8"	301.525
12"	304.700
12 1/8"	307.875
12 1/4"	311.050
12 3/8"	314.225
12 1/2"	317.400
12 5/8"	320.575
12 3/4"	323.750
12 7/8"	326.925
13"	330.100
13 1/8"	333.275
13 1/4"	336.450
13 3/8"	339.625
13 1/2"	342.800
13 5/8"	345.975
13 3/4"	349.150
13 7/8"	352.325
14"	355.500
14 1/8"	358.675
14 1/4"	361.850
14 3/8"	365.025
14 1/2"	368.200
14 5/8"	371.375
14 3/4"	374.550
14 7/8"	377.725
15"	380.900
15 1/8"	384.075
15 1/4"	387.250
15 3/8"	390.425
15 1/2"	393.600
15 5/8"	396.775
15 3/4"	399.950
15 7/8"	403.125
16"	406.300
16 1/8"	409.475
16 1/4"	412.650
16 3/8"	415.825
16 1/2"	419.000
16 5/8"	422.175
16 3/4"	425.350
16 7/8"	428.525
17"	431.700
17 1/8"	434.875
17 1/4"	438.050
17 3/8"	441.225
17 1/2"	444.400
17 5/8"	447.575
17 3/4"	450.750
17 7/8"	453.925
18"	457.100
18 1/8"	460.275
18 1/4"	463.450
18 3/8"	466.625
18 1/2"	469.800
18 5/8"	472.975
18 3/4"	476.150
18 7/8"	479.325
19"	482.500
19 1/8"	485.675
19 1/4"	488.850
19 3/8"	492.025
19 1/2"	495.200
19 5/8"	498.375
19 3/4"	501.550
19 7/8"	504.725
20"	507.900
20 1/8"	511.075
20 1/4"	514.250
20 3/8"	517.425
20 1/2"	520.600
20 5/8"	523.775
20 3/4"	526.950
20 7/8"	530.125
21"	533.300
21 1/8"	536.475
21 1/4"	539.650
21 3/8"	542.825
21 1/2"	546.000
21 5/8"	549.175
21 3/4"	552.350
21 7/8"	555.525
22"	558.700
22 1/8"	561.875
22 1/4"	565.050
22 3/8"	568.225
22 1/2"	571.400
22 5/8"	574.575
22 3/4"	577.750
22 7/8"	580.925
23"	584.100
23 1/8"	587.275
23 1/4"	590.450
23 3/8"	593.625
23 1/2"	596.800
23 5/8"	600.075
23 3/4"	603.250
23 7/8"	606.425
24"	609.600
24 1/8"	612.775
24 1/4"	615.950
24 3/8"	619.125
24 1/2"	622.300
24 5/8"	625.475
24 3/4"	628.650
24 7/8"	631.825
25"	635.000

TRAILER



EDGE GLIDES TRAILER SNOWMOBILE SKI EDGE GLIDE SYSTEM

An innovative accessory that provides smooth Edge transition from the ground to your trailer or ramp.

- Innovative Edge Glides Measure 5 7/8" x 8 3/4"
- Incorporates Caliber's proven friction-reducing glide technology
- Slotted fastening system allows for expansion and contraction, preventing warp
- Integrated edge for easy assembly
- Stainless steel screws install with ease
- 9" width accommodates all skis, ski stances and ATV/UTV tires
- High-Impact plastic (HDPE), guaranteed not to crack, chip, break or warp out
- Made in USA and includes Caliber's lifetime warranty

PART #	MFG #	DESCRIPTION
22-13362	34.95 13362	Edge Glide Tilt (4 pcs w/o Hinges)

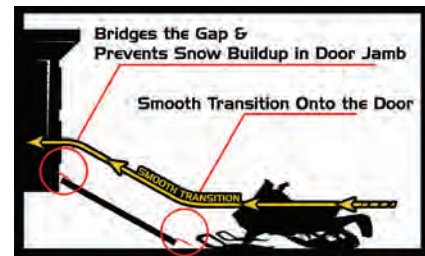



MULTI GLIDES SIMPLIFIES LOADING AND UNLOADING OF SNOWMOBILES

Reduced friction between ski and trailer makes loading & unloading quick and easy.

- Deep channel suspends all types of carbide runners
- Wide design accommodates all dual runner skis
- Eliminates damage to trailer decking caused by carbide ski wear rods
- Multi-Glides accommodates snowmobiles with up to 7" of ski stance variance
- Multi-Glides Wide accommodates snowmobiles with up to 11" of ski stance variance
- Guaranteed not to crack, chip, break or wear out

PART #	MFG #	DESCRIPTION
PD3305	84.95 PM13305	Multi-Glides - Single Set (20 Feet Total)
PD3306	94.95 PM13306	Multi-Glides Wide - Single Set (20 Feet Total)
PD3310	134.95 PM13310	Multi-Glides - Double Set (40 Feet Total)
PD3311	169.95 PM13311	Multi-Glides Wide - Double Set (40 Feet Total)
PD3313	49.95 PM13313	Multi-Glides - Extension Set (10 Feet Total)
PD3314	59.95 PM13314	Multi-Glides Wide - Extension Set (10 Feet Total)
PD0103	0.95 CHP0103	Multi-Glides - Screw Pack (8 Screws)
PD3308	16.95 CR0106	Multi-Glides - Single 5 Foot Section
PD3309	21.95 CR0107	Multi-Glides Wide - Single 5 Foot Section



FLEX GLIDES TRAILER LOADING AND UNLOADING SHOCK SYSTEM

Guides the snowmobile off your trailer and onto the ramp.

- Flex-Glides Low and High can be combined to complete enclosed V-Front trailers
- Designed to adjust to fit any V-Front trailer
- Protect your trailer and skis from unnecessary damage
- Made of high quality HDPE plastic for durability

PART#	MFG #	DESCRIPTION
PD3342	42.95 PM13342	Low Profile, 8 Piece Set
PD3343	47.95 PM13343	High Profile, 8 Piece Set

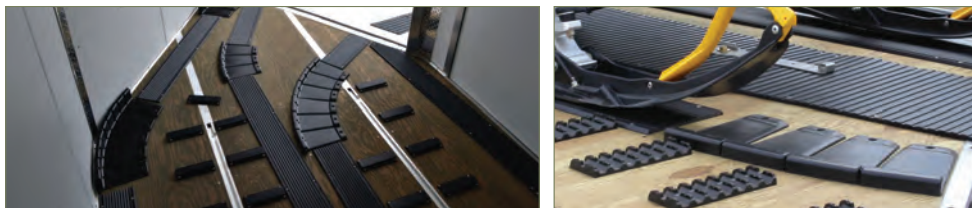
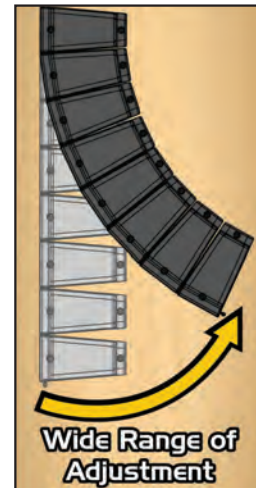
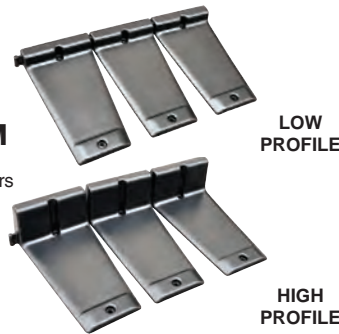

LOWPRO GLIDES SIMPLIFIES LOADING AND UNLOADING OF SNOWMOBILES

Reduced friction between ski and trailer makes loading & unloading quick and easy. Low profile design allows your snowmobile to glide on and off trailer without causing interference while hauling furniture or anything you need to haul.

- Eliminates damage to trailer decking caused by carbide wear rods
- Has a 45° angled edge to reduce interference
- LowPro Glides Wide (8" wide) accommodate all dual runner skis
- LowPro Glides (6" wide) now accommodate all Polaris and Woody's dual runner wear bars
- LowPro Glides accommodate snowmobiles with up to 8.5" of ski stance variance
- LowPro Glides Wide accommodate snowmobiles with up to 12.5" of ski stance variance
- HDPE guaranteed not to crack, chip, break or wear out

PART #	MFG #	DESCRIPTION
PD3325	16.95 CR0121	LowPro Glides - Single 5 Foot Section
PD3327	19.95 CR0122	LowPro Glides Wide - Single 5 Foot Section
PD0103	0.95 CHP0103	LowPro Glides - Screw Pack (8 Screws)
362061	139.95 13372	LowPro Glides - narrow 6" Double set (16 pcs)
362060	44.95 13370	LowPro Glides - narrow 6" Extension (Set of 4 30" pcs)
362063	159.95 13375	LowPro Glides - narrow 9" Double set (16 pcs)
362062	49.95 13373	LowPro Glides - narrow 9" Extension (Set of 4 30" pcs)
362075	59.95 13376	Lowpro Glide - Wide (11.5") - Extension Set - 4pc.
362076	109.95 13377	Lowpro Glide - Wide (11.5") - Single Set - 8pc.
362077	199.95 13378	Lowpro Glide - Wide (11.5") - Double Set - 16pc.
362081	89.95 13374	LowPro Glides - 9" Single Set



- tires & wheels
- axles, hubs & springs
- tongue accessories
- hitches
- electrical
- brake parts
- trailer hardware
- locks & pins
- towing & loading
- tie downs
- tools
- chemicals

TRAILER

TOWING & LOADING



LOADING MADE SAFER!



GREAT FOR TRAILER DOORS!

- Innovative containment system providing safety for loading/unloading
- Three feature set: Containment, Glide, Grip
- New design combines Flex Glide High & LowPro Grip Glide into one great product
- Increased safety factor makes loading/unloading easier for all ages
- Protects door cables from being caught by skis

PRODUCT DIMENSIONS:
includes 12-10.75" pieces and stainless hardware

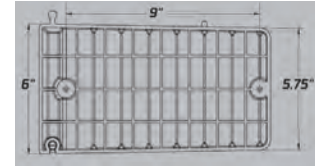

PART #	MFG #	DESCRIPTION
362053	94.95	13388 Edge Guard (12 pc kit)



LOWPRO GRIP GLIDES GRIPS FOR YOUR ATV AND GLIDES FOR YOU SNOWMOBILE

Designed specifically for those that carry both ATVs and snowmobiles.

- Great for Enclosed Trailer Doors and Tilt Trailers! No More Slipping!
- Provides excellent traction when loading and unloading your ATV
- Drastically reduces friction when loading and unloading your snowmobile
- 9" wide to accommodate a 14" ski stance variance
- Uniquely made to be supported off the trailer deck
- Holes on top to make washing after a muddy day effortless
- HDPE guaranteed not to crack, chip, break or wear out



MFG #	DESCRIPTION		
13385	Lowpro GripGlide - Wide (11.5") - Extension Set - 4pc.	362071	69.95
13386	Lowpro GripGlide - Wide (11.5") - Single Set - 8pc.	362072	124.95
13387	Lowpro GripGlide - Wide (11.5") - Double Set - 16pc.	362073	229.95
13380	Lowpro GripGlide - Single Set 6" (8pcs)	362079	99.95
13381	Lowpro GripGlide - Double Set 6" (16pcs)	362080	184.95
13379	Lowpro GripGlide - Extension 6" (4pcs)	362078	54.95

PART #	DESCRIPTION
362065	109.95 LowPro GripGlide Single Set 9" (8 pcs)
362064	59.95 LowPro GripGlide Extension Kit 9" (4 pcs)
362066	199.95 LowPro GripGlide Double Set 9" (16 pcs)



TRAILER



GRIP GLIDES SNOWMOBILE TRAILER SKI GLIDE GRIP SYSTEM

An innovative accessory to help load your snowmobile and ATV onto 10' tilt trailer.

- Grips for ATV tires
- Glides for snowmobile carbide wear bars
- Headache free loading and unloading



PART #	MFG #	DESCRIPTION
PD3350	69.95	13350 Grip Glides Ramp Set (Set of 22)
PD3351	89.95	13351 Grip Glides Ramp Set (Set of 32)

GRIP GLIDES RAMP KIT SNOWMOBILE TRAILER SKI GLIDE GRIP SYSTEM FOR RAMPS

- The proven versatility of GRIP GLIDES is also available for open-frame ramps on flatbed trailers
- Set includes 16 pieces, enough for one side of a ramp
- Two sets will complete both sides



PART #	MFG #	DESCRIPTION
PD3352	64.95	13352 Grip Glides Ramp Set (Set of 16)

Try our **NEW** Online Configurator!
caliberproductsinc.com



- Takes Out All Of The Guesswork
- Calculates the Amount of Product You Will Need
- Creates a Printable Parts List
- Saves Time



GRIPS TRAILER SNOWMOBILE TRACK GRIP SYSTEM

Low Cost Maximum Traction for loading your Snowmobile

- Excellent Option for Deeper Lug tracks
- Excellent traction and braking control while loading or unloading
- Proprietary Impact Modified Polyolefin plastic makes Grips extremely durable
- Prevent the track from freezing to your trailer deck
- Provides superior performance as compared to any other grip type product
- Flexible, Strong and guaranteed to last!
- Made in USA and includes Caliber's Lifetime Warranty



PART #	MFG #	DESCRIPTION
362002	29.95	13200 Grips - 6 Pack
PD3200	3.95	CR0102 Grips - Sold Each (no hardware)



TRAX GRABBER EFFORTLESS LOADING OF YOUR SNOWMOBILES.

Modified High Density TPO with Stainless Steel Hardware for Strong Lifelong Performance.

- Innovative lug pattern provides smooth interlocking Grip for your track.
- Strategic lug placement engages 2.5", 2.86" and 3.0" pitch tracks.
- Great for all tracks including Paddle Tracks and Studded tracks.
- 16" width accommodates all track widths without overhang.
- Great Low Profile design makes for safe walking.
- High-impact plastic (TPO), guaranteed not to crack, chip, break or wear out.
- Stainless steel screws ; installs with ease will not rust.
- Flexible, Strong and Guaranteed not to break.
- Made in USA and includes Caliber's lifetime warranty.



PART #	MFG #	DESCRIPTION
562002	34.95	23060 Trax Grabber, Double Set (2 pcs w/40 pc stainless hardware kit)



REFLEX RUBBER TRACTION PAD

"THE WAY TO PROTECT YOUR TRAILER FLOOR"

- 1/2" x 18" x 10'
- Made of 100% recycled materials, largely recycled tires
- Reflex rubber traction pad is an economical solution to protect specified areas of your trailer's floor from damage resulting from your snowmobile's studded track
- Reflex rubber traction pad is a processed board product formed by blending granular crumb rubber derived from discarded tires and various low density polymer components pre-molded under heat and pressure
- Recommended fasteners: zinc or stainless screws w/ a 3/4" minimum washer (not included)
- Sold each



PART #	MFG #
531810	62.95 MRT121810



TRAX SAVER SAVE THE TRACK PADDLES!

Long Lasting, No Hardware Necessary

- Saves Track paddles from damage during transport, by raising them off deck surface
- Easily tucks underneath paddles, once snowmobile is loaded
- Designed to work with Caliber Trax Grabber
- Made from highly durable, proprietary rubber blend



PART #	MFG #	DESCRIPTION
362009	34.95	23062 TraxSaver (Mountain)



TRAXMAT THE BEST SNOWMOBILE TRACTION MAT ON THE MARKET

Stop the damage to your trailer decking or ramp caused by studded tracks.

- Provides excellent traction when loading and unloading your snowmobile
- Available in 54" and 72" length
- Extra wide 18" width
- Unique bottom groove design allows moisture to dissipate and dry out; preventing trailer deck rot

PART#	MFG #	DESCRIPTION
PD3210	49.95	PM13210 TraxMat - 54"
PD3211	59.95	PM13211 TraxMat - 72"



- tires & wheels
- axles, hubs & springs
- tongue accessories
- hitches
- electrical
- brake parts
- trailer hardware
- locks & pins
- towing & loading
- tie downs
- tools
- chemicals

TRAILER

TOWING & LOADING

- tires & wheels
- axles, hubs & springs
- tongue accessories
- hitches
- electrical
- brake parts
- trailer hardware
- locks & pins
- towing & loading
- tie downs
- tools
- chemicals



HD TRACTION LADDER

- Extended traction for loading on icy surfaces
- RampGrips protect rungs for studded tires
- Collapses for easy storage in the bed or cab of your truck
- Over-sized ramp hooks for easy use
- Rubber feet for grip on most loading surfaces
- Specs: 12" W x 64" L – Capacity: 500 lbs.
- For snowmobile use ONLY

PART #	MFG #
362090	159.95 13566



Retractable Strap™

Additional strap required when ramp is split for ATVs



PART #	MFG #	DESCRIPTION
362046	24.95 13548	Moto Ramp Pro Retrax Strap - 1 pc.



V-FRONT RAMP SHIELD PROTECTION WHILE YOU TRAILER, EASIER UNLOADING WHEN YOU HAVE ARRIVED

Protects your snowmobiles, ATVs and motorcycles from road grime, rocks and salt while hauling.

- Universal design fits most open trailers - 30" tall
- Aerodynamic design to help with gas mileage
- Our new LowPro GripGlides are installed on the ramp to make unloading your snowmobile and ATV simple
- Molded Grips down the center to give your snowmobile track traction
- Protective gate to keep your ski away from the bumper of your tow vehicle
- Lightweight HDPE guaranteed not to crack, chip, break or wear out
- Stainless steel hardware included



362001



362040

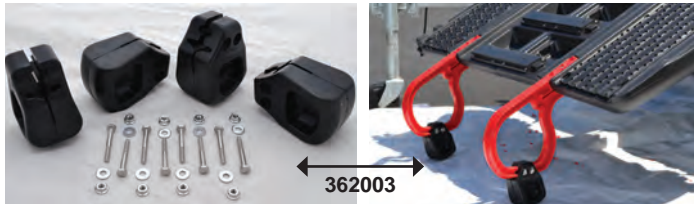
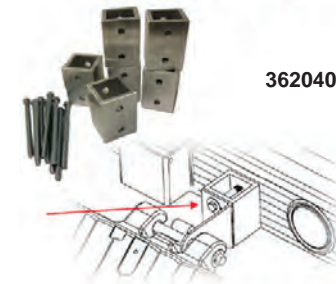

362003

PART #	MFG #	DESCRIPTION
PD3404	639.95 13404	V-Front Ramp Shield w/ LowPro GripGlides
362001	174.95 CA0212	V-Front Ramp Shield Adapter Kit for Triton Double Axle & Snopro V Front
362040	129.95 CA0209	V-Front Ramp Shield Adapter Kit for Aluma/Sledbed
362003	49.95 13408	V-Front Ramp Shield Handle Extender Kit (4 Piece)

TRAILER



POLY SHIELD III ULTIMATE ROAD SPRAY PROTECTION

Protects the resale value of your snowmobile, ATVs and motorcycles by deflecting corrosive salt & road spray.

- 25.5" high and fits trailers from 95" to 102" wide without modification
- Removes in seconds with included Quick-Detach kit
- Quick-Detach works on V-Front drive-on, drive-off trailers
- Will not shatter, crack, split or dent and is impervious to destructive road spray and foreign chemicals or fluids
- Unique molded spray channels enhance aerodynamics and help to direct road spray to the sides of the trailer and away from snowmobiles, ATV's, motorcycles
- Molded of HDPE plastic, providing ultra-rigid strength and the same durability proven in the truck bed liner industry
- Shield is not affected by extreme cold temperatures

NOT AFFECTED BY EXTREME COLD OR ROAD DEBRIS!

HIGH QUALITY HDPE PLASTIC



POWDER COATED STEEL TUBE

QUICK - DETACH KIT

PART #	MFG #
PD3401	399.95 13401

AUTOMATIC DISTRIBUTORS

www.autodist.com | 207-942-6769



1,200 lbs. load rating / 600 lbs. per side

THE MOST VERSATILE RAMP ON THE MARKET FOR ALL YOUR TOYS!

Moto RampPro For a more specific use than our traditional RampPro, the Moto RampPro is a seperable, bi-fold ramp, designed for ATVs, Dirt Bikes, and Snowbikes. With a 1,200 lb.* capacity, (600 lbs Per Side) this ramp will accommodate most of your loading needs. A snowbike loading system has finally arrived. No more getting help trying to load. This simple, safe and effective bi-fold ramp is designed for more than just snow bikes, Moto ramp is also amazing for Dirtbikes and ATVs. With a 1,200 lb.* capacity, (600 lbs Per Side) this ramp will accommodate most of your loading needs. Designed specifically to address loading of snowbikes.

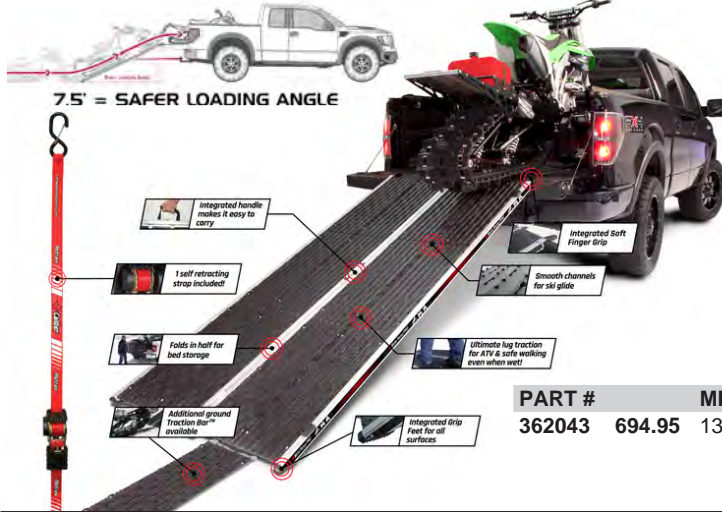

PART #	MFG #	DESCRIPTION
362043	694.95 13560	Moto Ramp Pro (Universal Snow Bike/Dirt/ATV Ramp)

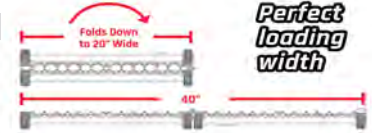

Perfect loading width

ADDITIONAL ACESSORIES (Sold Separately)



Moto TractionBar Designed to give your Snowbike added traction when loading on hard, packed, or icy surfaces, becomes difficult. Easy-attach connections allow you to accommodate to the situation in a snap. The Moto TractionBar is the perfect companion for the Moto RampPro when loading Snowbikes in situations that are not ideal.

PART #	MFG #	DESCRIPTION
362044	119.95 13562	Moto Traction Bar (90° Ground Traction Bar for Moto Ramp)

WHEN ADDITIONAL GROUND TRACTION IS NEEDED!

INCLUDES:

Traction Bar Hooks and hardware. Mounts directly to your ramp bottom cross rail.



RAMP PRO 2.0 SNOW AND ATV

SMOOTH CHANNELS FOR SKI GLIDE



FOLDS DOWN TO 26" WIDE

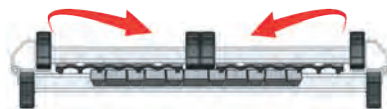

ULTIMATE LUG TRACTION FOR ATV AND SAFE WALKING

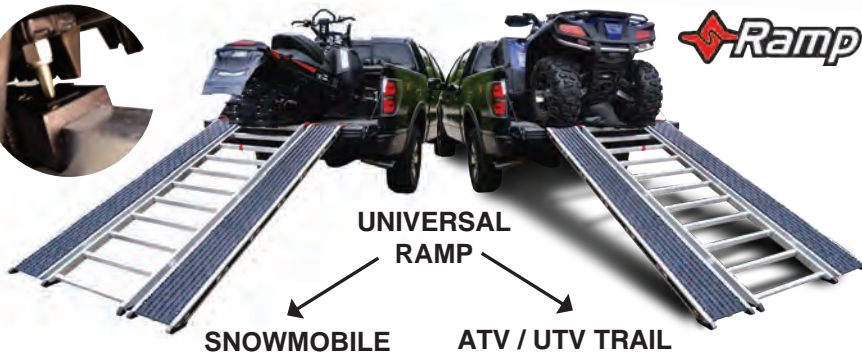

Safe and Effective Grips and Glides make loading and unloading effortless!

- Innovative grip design provides superior traction for all wheel vehicles
- Incorporates Caliber's proven friction-reducing Snowmobile Carbide glide technology
- Low Pro Grip Glides provides the markets safest walk (up and down the ramp)
- Slotted fastening system allows for expansion and contraction, preventing warp
- Universal Design accommodates almost all Snowmobile and ATV stances
- Includes Caliber's Self-Retracting strap for easy mounting to your Vehicle
- 52"wide x 90" long makes for a comfortable loading angle
- 1500lb. rating Includes Caliber's lifetime warranty

PART #	MFG #	DESCRIPTION
362068	694.95 13204	Ramp-Pro 2.0 Ramp Grips for Studded Tracks (6 pc. 15" pieces) 2 required



tires & wheels

axles, hubs & springs

tongue accessories

hitches

electrical

brake parts

trailer hardware

locks & pins

towing & loading

tie downs

tools

chemicals

TRAILER

TOWING & LOADING

- tires & wheels
- axles, hubs & springs
- tongue accessories
- hitches
- electrical
- brake parts
- trailer hardware
- locks & pins
- towing & loading
- tie downs
- tools
- chemicals



RAMP GRIPS RAMP PROTECTION FOR STUDDED TRACKS

Protect your ramp and Climb on with Ease!

- Excellent traction and braking control while loading or unloading
- Gives superior traction and protection from stud penetration
- Wraps right around your 1" Bars on any ramp
- One side can be cut for larger sizes Cross Bars
- 15" length protects ramp from all Track widths
- Each 6 piece kit comes with Stainless Steel Torque fasteners and driver
- Flexible, Strong and Guaranteed to last!
- Made in USA and includes Caliber's lifetime warranty



PART #	MFG #	DESCRIPTION
362019	29.95 13204	Ramp Grips (6 pcs 1" x 15" kit)



A SAFE AND EFFECTIVE LOADING SOLUTION!

- Quickly add Ramp Bridge on your Ramp for instant access of loading/unloading of your snowbike
- Comes with 2 ramp grips per kit that can be located on the ends of the ramp bridge
- Easily cut inside edges of Ramp Grips to let the bridge fit cross rails over 1"
- Easily cut Ramp Bridge length according to the length of your ramp
- Can be used on a sled deck ramp or any trailer or truck ramp
- Additional sets can be used along side of each other for additional glide and traction walking surface

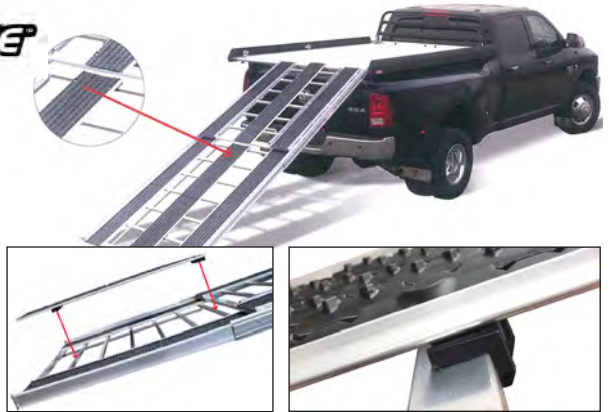

PART #	MFG #	DESCRIPTION
362045	99.95 13574	Sled Deck Ramp Bridge



ALUMI-SKIN™

ALUMI-ETCH™

ONLY THE BEST ALUMINUM CLEANER & PROTECTION!



TRAILER

ALUMI-SKIN™

CLEAR PROTECTIVE ALUMINUM COATING

- Clear protective coating
- Preserves Aluminum
- Highly Corrosion Resistant
- Highly Cleansable Surface
- Restores Appearance
- Long-Lasting Protection



PART #	MFG #	DESCRIPTION
362057	24.95 13573	ALUMI-SKIN 8 oz. can
362041	99.95 13570	ALUMI-SKIN 1 qt. can

ALUMI-ETCH™

ALUMINUM SURFACE PREP AGENT

- Streak free finish
- No scrubbing, just spray and rinse
- Will Not harm carpet, bunks, wiring rubber, paint or vinyl decals
- Apply at full strength or dilute up to 10:1 to achieve desired results
- Removes years of build-up in just minutes
- Uniform OFF WHITE finish



PART #	MFG #	DESCRIPTION
362042	44.95 13572	ALUMI-ETCH 1 qt. bottle



RETRAX AUTO RETRACTABLE STRAP

Retrax Straps for effortless securing of all your powersport toys

- Self retracting power spring strap
- No more feeding straps, no more tying off loose ends, no more tails, no more knots and frustrated adjusting
- Install in 15 seconds!
- Extra large 2" hook with integrated spring clip
- High strength 1500 lb strength with 500 lb working load rating
- Short 6' length that makes it simple for all powersports tiedowns
- Flexible, strong and guaranteed to last!
- Made in USA and includes Caliber's lifetime warranty



PART #	MFG #	DESCRIPTION
362021	39.95 13412	Retrax 2 pcs 1" x 6' Auto Retractable Strap



BARR LOCK

Extremely effective and economical snowmobile theft prevention device no snowmobiler should be without.

- Precision formed from high-strength steel
- Tough black powder coating protects against rust and corrosion
- Fits virtually all popular style draw bars, including vinyl coated bars
- Secures with 2" padlock (not included)



PART #	MFG #
PD3501	14.95 13501



D-RING ANCHOR 2 PIECE TIE DOWN KIT

Strong, durable and noiseless Tie-Down system.

- Powerful Retail Presence for Dealers.
- Each pack includes 2 D-Rings.
- Rated to 5,000 lbs.
- Kit includes all hardware.
- Flush mount so it doesn't interfere with your cargo.
- Available in Stainless Steel or Zinc Plated.
- Backer plate included, standard.

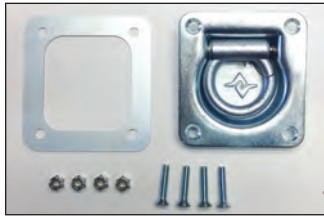

PART #	MFG #	DESCRIPTION
362005	39.95 13520	D-Ring Set Zinc
362006	79.95 13521	D-Ring Set Stainless



Universal Trailer Handle

CALIBER UNIVERSAL TRAILER HANDLE

Long Lasting & Durable. Fits Any Trailer.

- Easily lift your trailer onto the hitch
- Keeps hands free of pinch points
- Avoid touching the freezing cold raw metal
- 9" Long & 2 1/4" High
- Comes with mounting hardware



PART #	MFG #	DESCRIPTION
362010	17.95 13522	Universal Trailer Handle



Trailer Lift

TRAILER LIFT TRAILER LOADING & UNLOADING SHOCK SYSTEM

Finally! A sensible way to hold your ATV, Snowmobile and Motorcycle trailer in the loading or unloading "tilt" position!

- High strength steel ends
- New rust proof shock shaft
- Easy single person loading & unloading operation
- Operates smoothly in extreme temperature
- Even works for enclosed tilt trailers!



New Steel Ends

Nitride Coated Shaft

PART #	MFG #
PD3511	44.95 PM13511

FAST SAME DAY SHIPPING

- tires & wheels
- axles, hubs & springs
- tongue accessories
- hitches
- electrical
- brake parts
- trailer hardware
- locks & pins
- towing & loading
- tie downs
- tools
- chemicals

TRAILER

TOWING & LOADING

- tires & wheels
- axles, hubs & springs
- tongue accessories
- hitches
- electrical
- brake parts
- trailer hardware
- locks & pins
- towing & loading
- tie downs
- tools
- chemicals



TILT-EZ

- An innovative trailer tilting system
- Mechanically tilts trailer
- Positive operation in both directions unlike anything else in the market
- Holds your trailer in a tilted position for easy loading and unloading
- Operated with an 18 volt drill or the supplied hand crank
- Yellow zinc and black powder coated for maximum corrosion resistance
- Quick and easy installation
- Removable ram for storage while traveling to keep Tilt-EZ out of the road elements
- Tilt-EZ is lubricated with a marine tech grease designed for salt water applications



DESCRIPTION	PART #
Tilt-Ez, Single Pole, No Center Lock	JSP100 299.95
Tilt-Ez, Wishbone Tongue	JSP110 299.95
Tilt-Ez, Single Tongue With Center Tilt Lock	JSP120 299.95

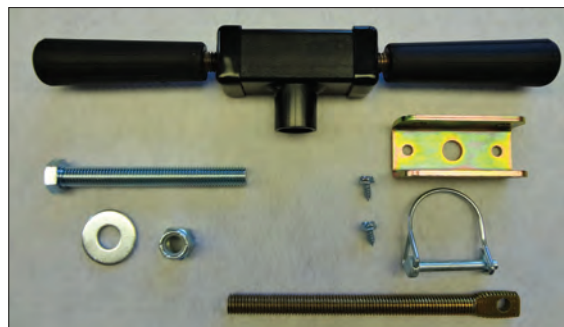
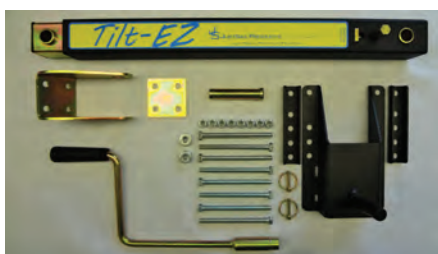

SECUREZ (QUICK SNOWMOBILE TIE DOWN SYSTEM)

- A unique and quick tie down system for your snowmobile skis secure your skis
- Utilizes a split nut design for a quick tie down and no hassle adjustment every time you secure your skis
- Yellow zinc plated and black E- coat for maximum corrosion resistance
- All internal components are lubricated with a marine tech grease designed for salt water applications

SINGLE
JSP200 89.95

SET OF TWO
JSP210 179.76

FLIP RAMP (TILT TRAILER REAR FLAP) SET OF TWO (8FT)

- FlipRamp is 9' x 48"
- Sold as a set (for full width trailers) or individually (for ramp doors and inline/V-nose trailers)
- Mounting brackets and hinges are made from aluminum for corrosion resistance
- The FlipRamp creates a FULL bridge from trailer to ground
- Innovative hinge system allows for easy FlipRamp removal with NO tools
- Additional FlipRamp Brackets are sold for easy storage on a trailer wall or garage wall

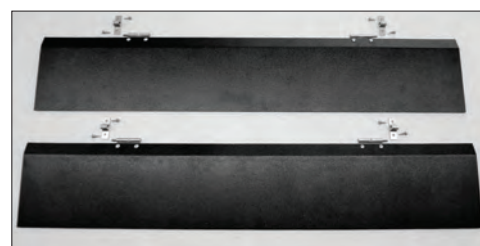

JSP400 96.95



FLIP RAMP 2 BRACKET KIT (REPLACEMENT/STORAGE)

- FlipRamp Storage Brackets allow for easy storage of the Flip Ramp on a trailer or garage wall
- Sold in a set of 2

JSP490 6.95

TRAILER

ENFORCER



TRAILER TILT BED BUDDY

- A great way to hold your tilt style trailer in the "up" position so you can load your snowmobile, ATV, etc.
- Eliminates the need to find something to prop-up your trailer while loading
- Smooth operation in all weather conditions
- Fits most tilt style trailers
- Heavy duty steel ends and rust proof shaft
- Installs in minutes with basic hand tools
- Hardware & instructions included

PART #	
EF3511	37.95

COVERED TRAILER GAS PROPS



- Black painted finish
- 922mm extended length
- 410mm stroke
- 13mm zinc plated ball socket ends
- Gas charged
- Shock only - no mounts



MFG #	DESCRIPTION	PART #	
SUSPA			
C16-17856	138 lbs. prop capacity	C16-17856	38.95
C16-19225	154 lbs. prop capacity	C16-19225	42.95
C16-22632	185 lbs. prop capacity	C16-22632	42.95
P67-00002E	13 mm Ball Stud	C16-17857	2.25
P68-00019A	Ball & Socket Retainer	RC19	0.65

	10' OEM (138 lbs)	10' HEAVY DUTY (154 lbs)	12' OEM (154 lbs)	12' HEAVY DUTY (185 lbs)
TRAILER				
TRITON	C16-17856	C16-19225	C16-19225	C16-22632
THULE/SNO-PRO	C16-17856	C16-19225	C16-19225	C16-22632
OTHERS	C16-17856	C16-19225	C16-19225	C16-22632

MFG #	DESCRIPTION	PART #	
BRONCO			
C16-19225	154 lbs. prop capacity	679443	36.95
C16-22632	185 lbs. prop capacity	679442	36.95
P67-00002E	13 mm Ball Stud	679444	1.50
P68-00019A	Ball & Socket Retainer	679445	0.50



MFG #	DESCRIPTION	PART #	
BRONCO			
P67-00002E	13 mm Ball Stud	679444	1.50
P68-00019A	Ball & Socket Retainer	679445	0.50



SUPERCLAMP II

THE #1 SNOWMOBILE TIE-DOWN SYSTEM

- Installs in seconds on any trailer or truck deck
- One pull of the ergonomically pistol grip handle instantly secures your sled
- Eliminates reaching over your salt shield or under your sleds belly pan
- Center tension knob fully adjustable to all snowmobiles
- Highly engineered composite construction will never rust
- Lockable with your padlock, Superclamp acts as a theft deterrent
- Compatible with all ski types
- Protect your skis with ribbed silicone rubber pads
- Includes a screw style deck hook
- Lightweight fiber-filled composite material



23-1001



496001



23-1003



496002

DESCRIPTION	PART #	
SUPERCLAMP - Front	23-1001	234.95
SUPERCLAMP - Rear w/ 12" SUPERTRAC Kit	496001	174.95
Deck Hook (Reg. Screw Style) Most Common	23-1003	19.95
Deck Hook (T-Style) Channel Mount	23-1004	19.95
Deck Hook (Extra Long Screw Style)	496002	21.95
SUPERTRAC Deck Hook (For SUPERTRAC)	496003	19.95



23-1004



496003

- tires & wheels
- axles, hubs & springs
- tongue accessories
- hitches
- electrical
- brake parts
- trailer hardware
- locks & pins
- towing & loading
- tie downs
- tools
- chemicals

TRAILER

FAST SAME DAY SHIPPING

TOWING & LOADING

SUPERTRAC

THE #1 MULTI-PURPOSE TIE-DOWN SYSTEM

The new SUPERTRAC is a multi-purpose, fully adjustable and lockable tie-down anchor system for use anywhere you need to tie down and secure cargo. SUPERTRAC can be installed in pick-up trucks, trailers, vans or just about anywhere you need to add an anchor point to tie down your cargo.

- Heavy Duty Aluminum Track
- Fully Adjustable
- End Caps Included
- Deck Hook Included
- Lockable



496005

- 12" KIT CONTENTS:
- 1 - 12" length of Supertrac
- 1 - Supertrac Deck Hook*
- 3 - pcs of stainless steel hardware
- 2 - End Caps / Screws
- 11 Possible Tie Down Locations

496007

- 48" KIT CONTENTS:
- 1 - 48" length of Supertrac
- 1 - Supertrac Deck Hook*
- 12 - pcs of stainless steel hardware
- 2 - End Caps / Screws
- 47 Possible Tie Down Locations

496006

- 24" KIT CONTENTS:
- 1 - 24" length of Supertrac
- 1 - Supertrac Deck Hook*
- 6 - pcs of stainless steel hardware
- 2 - End Caps / Screws
- 23 Possible Tie Down Locations



496010

496009

DESCRIPTION	PART #	
SUPERTRAC 12" Kit	496005	38.95
SUPERTRAC 24" Kit	496006	47.95
SUPERTRAC 48" Kit	496007	69.95
SUPERTRAC Hardware Kit	496009	12.49
SUPERTRAC End Caps	496010	6.75



TIE DOWN CRANKS

- 2 lengths
- 1/2" thread

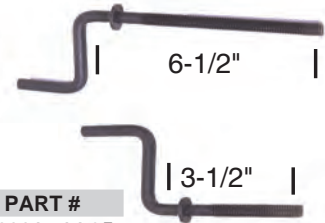

MFG #	DESC.	PART #	
DMA6012	3-1/2"	220001	14.95
DMA6014	6-1/2"	220002	19.95

TRAILER

SUPER-TRACTION GRID

TRACTION GRID FOR YOUR TRACK



YOUR SLED GLIDES

YOUR ATV GRIPS

- Total Footprint (as pictured): 16.5" x 60"
- Kit Contains 4 pcs (8.25" x 29.5") plus hardware

- Traction Grid's strategic grid pattern, provides incredible grip and accommodates all snowmobile tracks even with paddles or studded
- Special grommet screws allow expansion and contraction
- Can be used with optional Edge Rail Trim kit

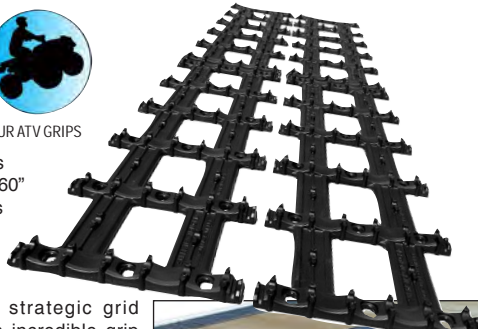

Shown installed on trailer with SuperGlides

PART

496012 84.95

RAMP CROSSBAR PROTECTOR

WITH TRACTION

Designed for 1" Crossbars

- Superior traction and helps prevent stud damage to loading ramps from studded tracks
- Designed to wrap around a 1 inch ramp cross bars, on solid, double and tri-fold loading ramps.
- Pieces are 7.5" long, two can be used together making 15" of width for center of ramp for Snowmobile tracks
- Available up to 24 piece kits
- Hardware included
- Protect your ramp investment



YOUR SLED GLIDES

YOUR ATV GRIPS

CONTENTS		PART #	
1 KIT	2 PCS W/ 6 SCREWS	496013	11.95
5 KITS	10 PCS W/ 30 SCREWS	496014	36.95
12 KITS	24 PCS W/ 72 SCREWS	496015	79.95



PATENTED TECHNOLOGY
SUPERGLIDES II
The sled and ATV glide with traction!
PRO

PATENTED TECHNOLOGY
SUPERGLIDES WIDE
The **WIDER** sled and ATV glide with traction!

SUPER-GLIDES II PRO

- No more ripping up the plywood on your trailer
- Allows skis to glide with ease
- Specially designed traction knobs provides improved traction for your feet
- Exclusive venting: protect the deck of your trailer from moisture damage
- Accommodates single or dual carbide skis
- Total length 20 ft. (6M)
- Each box contains 8 pcs: 8.5X 29.5 inch (21.5 X 74.9cm)
- Comes with 48 specially coated screws with grommets
- Can be used with optional Edge Rail Trim kits

SUPER-GLIDES II WIDE

- No more ripping up the plywood on trailer floor
- Allows sled skis to glide with ease
- Specially designed traction knobs provides improved traction for your feet
- Oval mounting channels and custom shoulder screws prevent warping by allowing for expansion and contraction that results from varying temperature
- Exclusive venting: protect the deck of your trailer from moisture damage
- Accommodates single or dual carbide skis
- Each box contains 8 pcs: 13.5X 29.5 inch (34.3 X 74.9cm)
- Total length 20 ft. (6m)
- Comes with 72 specially coated screws with grommets
- Can be used with optional Edge Rail Trim kit



SUPERGLIDE EDGE RAIL TRIM

- To secure Superglides & Traction Grid on ramps or decks leaving an encapsulated finished edge.
- Each box contains 8 pcs with self-tapping screws
- Each box of Edge Rail Trim does one box of glides or traction grid.

STYLE	PART #	
STD	496000	119.95
WIDE	496011	174.95
EDGE RAIL KIT	496004	64.95

TIE DOWN CRANKS

- Yellow zinc plated
- Replace your present crank with this 2" diameter swivel handle that spins freely for a quicker tie down or release with improved leverage



MFG #	DESC.	PART #	
D780312	1/2" x 13	220003	24.95

TRAILER TIE DOWN BARS

- Two sizes
- A simple and easy way to clamp your sleds down to your trailer
- Comes with rubber covered end cap for ski protection



MFG #	DESCRIPTION	PART #	
3327	1-1/4" x 1-1/4"	AE3327	42.17
3328	1" x 2"	AE3328	42.17



TIE DOWN CRANK PLATE

Bottom plate 1/8" mild steel with 1/2" nut welded on



MFG #	PART #	
SM-12123	6212123	9.95

tires & wheels

axles, hubs & springs

tongue accessories

hitches

electrical

brake parts

trailer hardware

locks & pins

towing & loading

tie downs

tools

chemicals

TRAILER

TOWING & LOADING

tires & wheels
axles, hubs & springs
tongue accessories
hitches
electrical
brake parts
trailer hardware
locks & pins
towing & loading
tie downs
tools
chemicals

TRAILER

TRAILER WINCHES

- Comfort grip handle
- Zinc plate finish
- High carbon steel gears
- Heavy duty rib reinforced frames
- Engineered to keep handle effort low for smooth and easy operation
- Drums drilled for winch strap installation
- Only winches that are shown to accommodate steel cable should be used with steel cable
- Cable keeper kits are included with the winches specifying steel cable
- Winches rated for steel cable have a larger drum hub to reduce or lessen the chance of kinking or fraying
- **NOTE:** FULTON Winches are **NOT** designed to be a human hoist and should never be operated when there are persons on or under the load being moved
- All Fulton winches are attractively boxed for display



444091



444093



444092



FT304

WEIGHT CAPACITY	GEAR RATIO	HANDLE LENGTH	STRAP SIZE	STRAP INCLUDED	MOUNTING HARDWARE	FINISH	PART #	
SINGLE SPEED F2								
1600	4.1:1	2 Position 6", 7"	20' x 2" w/Hook	YES	YES	Sharkskin	444091	186.96
2000	5.1:1	4 Position 6", 7", 8", 9"	20' x 2" w/Hook	YES	YES	Sharkskin	444092	249.71
TWO SPEED F2								
3200	5.1:1, 3.17:1	4 Position 6", 7", 8", 9"	20' x 2" w/HD Hook	YES	YES	Sharkskin	444093	335.64

WEIGHT CAPACITY	GEAR RATIO	HANDLE LENGTH	RATCHET TYPE	ROPE	CABLE	STRAP SIZE	STRAP BOLT SIZE	STRAP INCL.	PART #
SINGLE SPEED FULTON									
1800	5.1:1	10"	TWO WAY	-	-	20' x 2"	3/8" x 2-3/4" GRADE 5	YES	FT304 175.42

HAND WINCHES

- Includes hook
- Nylon strap attached
- Winch does free wheel
- Zinc plated
- 2 sizes
- Cranks in and out under load
- Full color retail package



PART #	LOAD CAPACITY	GEAR RATIO	HUB SIZE	HANDLE LENGTH
BY800	45.02	800#	4.1:1	1-1/2" x 26'
BY820	88.95	2000#	9.8:1	2" x 20'



XLT SERIES CUSTOMIZED WINCHES

20' WINCH STRAP W/HOOK INCLUDED

- 1400# capacity - 4.1:1 gear ratio
- Zinc plated finish on winch
- High carbon steel gears
- 8" comfort grip handle
- Two way ratchet
- Polypropylene plastic shell
- 20' x 2" drum storage strap
- Black only
- Boxed



PART #	LOAD CAPACITY	GEAR RATIO	HUB SIZE	HANDLE LENGTH	RATCHET TYPE	HAND BRAKE	REPLACEMENT HANDLE #
----	1400#	4.1:1	3/4"	8"	Two Way	No	FT6302 29.24
FT304	175.42	1800#	5.1:1	7/8"	Two Way	No	----

WINCH STRAPS

- Winch straps are 2" wide and have an overall tensile strength of 5000#
- Easy to install and no more tangling in the drum!
- Each strap is skin packaged and comes with a heavy duty forged latch hook

SIZE	DESCRIPTION	PART #	
2" x 15'	5000# w/loop end	LR50465	15.14
2" x 20'	5000# w/loop end	LR50470	16.40
2" x 20'	5000# w/tail	LR50472	18.68
2" x 25'	5000# w/loop end	LR50475	17.86



HAND WINCH STRAPS WITH CASTED HOOK

- Cast hook with safety hatch
- Bolt on
- Display packaged

SIZE	STRENGTH	COLOR	PART #	
2" x 25'	3300#	Black	EK06404	24.95
2" x 20'	10,000#	Blue	EK06410	28.95



EK06410



EK06404

WINCH STRAP & HOOK

2" x 20' nylon web winch strap with loop end



FT207 22.41

HEAVY DUTY WINCH STRAP AND HOOK

- 2" x 20' 10,000 lb minimum breaking strength
- 4,000 lb max working load



444114 38.14

WINCH CABLES

- Galvanized steel 7 x 9 aircraft cable is made to handle the heavy loads
- Each cable is fitted with a heavy duty galvanized latch hook, pull proof loop and a fastener end for replacement use on Powerwinch, DL, Superwinch and other quality power winches
- Also great for hand crank winches

SIZE	STRENGTH	PART #	
5/32" x 25'	2800#	LR59378	23.49
3/16" x 20'	4200#	LR59379	22.81
1/8" x 20'	2000#	LR59380	20.79
3/16" x 25'	4200#	LR59385	31.17
3/16" x 50'	4200#	LR59390	38.37
7/32" x 25'	5600#	LR59395	29.18
7/32" x 50'	5600#	LR59400	37.84



SNAP HOOK

- Forged steel with tensile strength of 7500#
- Sold each (bulk)



CS16795 7.95

SNAP HOOKS

- Replace your worn out hook with a new zinc plated forged latch hook
- Skin packaged each

STRENGTH	PART #	
7000#	LR50640	6.44
7500#	LR50645	11.52
12,000#	LR50641	11.30



WINCH HOOK & CABLE

- 3/16" x 25' galvanized cable with attached snap hook
- 4200# nominal strength



FT325 31.81

BOW SAFETY CHAIN

- Safety chain connects the boat to the bow stand of the trailer
- 3/16" x 15-1/2"
- Packaged each



LR81201 6.60

FAST SAME DAY SHIPPING

tires & wheels
axles, hubs & springs
tongue accessories
hitches
electrical
brake parts
trailer hardware
locks & pins
towing & loading
tie downs
tools
chemicals

TRAILER

TOWING & LOADING

ROLLER BRACKET ASSEMBLIES

PRE-ASSEMBLED FOR EASY INSTALLATION

- Strong hot-dipped galvanized brackets hold shock-absorbing rollers to give proper keel support

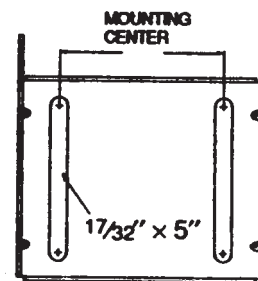

17/32" x 5" slot for verticle adjustment.
Attach with 1/2" or 7/16" bolts.

BLACK RUBBER

PART #		ROLLER	SHAFT	MOUNTING CENTER
CS10400	44.90	4" Spool	5/8"	2"
CS10401	51.35	5" Keel	5/8"	3"
CS10403	74.49	8" Keel	5/8"	6"
CS10404	86.06	10" Keel	5/8"	8"
CS10405	100.18	12" Keel	5/8"	10"

YELLOW RUBBER

CS10453	92.49	8" Keel	5/8"	6"
CS10455	110.45	12" Keel	5/8"	10"



CS10453

WOBBLE ROLLER RETAINER RINGS

- Packs of 2 rings with washers
- Used to hold wobble rollers



CS10980 14.05
Washer SAE 1-1/8"

STATIONARY KEEL ROLLER BRACKETS

- Mount on tongue or frame for keel support
- No mounting hardware included
- Sold each (bulk)

GALVANIZED



For Frame
2-3/4" Hole Centered
4" Roller

CS32100
43.64



For 2" Wide Tongue
2-3/4" Hole Centered
4" Roller

CS32110
43.63



For 3" Wide Tongue
3-1/2" Hole Centered
5" Roller

CS32150
44.93

ADJUSTABLE TONGUE KEEL ROLLER BRACKETS

- Offset brackets mount on tongue to hold roller for keel support
- Assembled
- Hardware included
- Display packaged
- Offset: 1"
- Length: 11-1/2"
- 3/8" diameter bolts



2 SIZES

PART #		DESCRIPTION
CS32003	52.63	For 3" Tongue
CS32005	57.79	For 2" Tongue
CS32004	20.51	Brackets Only, Pair

TRAILER

SPRING LATCH WELD ON

- 5/8" x 4" (overall) zinc plated pin
- 2-1/2" loop handle
- Stainless steel spring and a 2" x 1-1/2" x 1-1/4" steel housing
- Retaining pin extends 7/8" past housing when closed and 7/32" when open

BY2598
11.28
Sold Each



TILT LATCHES

- Designed for tilt style trailers and utility trailer gates
- Weld or bolt to tongue
- Plain base of 7 ga. steel
- Handle, spring, and plunger are zinc plated
- Sold each (bulk)

PART #		DESCRIPTION	MOUNTING
BY382	11.95	1/4" Four Way	Bolt On/Weld On



ANGLE "L" BRACKETS

- Use as top mounted roller bracket or as tie down
- Heavy 7 gauge steel, hot dipped galvanized for long life
- Holds 1/2" roller shaft
- 2" x 2-1/2"
- Sold in pairs

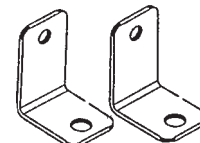

GALVANIZED

CS10211 14.08

BLACK BOAT TRAILER ROLLERS ROLLERS ARE OEM REPLACEMENTS FOR MANY TRAILERS

HD KEEL ROLLERS



PART #	LENGTH	DIA.	SHAFT
690098	22.95	12"	3-1/2" 5/8"
690096	21.95	10"	3-1/2" 5/8"
690088	17.95	8"	3-1/2" 5/8"

SUPER HD KEEL ROLLERS



PART #	LENGTH	DIA.	SHAFT
690055	21.95	8"	3-1/2" 5/8"
690053	17.95	5"	3" 5/8"

SPOOL ROLLERS



PART #	LENGTH	DIA.	SHAFT
690075	9.95	8"	3" 5/8"
690046	8.95	5"	3" 5/8"
690045	8.95	5"	3" 1/2"
690044	7.95	4"	3" 1/2"

MOLDED SIDE GUIDE ROLLERS

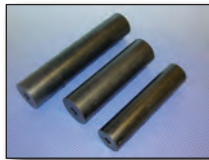

PART #	LENGTH	DIA.	SHAFT
690128	17.95	12"	2-1/2" 5/8"
690126	9.95	9"	2" 1/2"

MOLDED Y BOW STOPS



PART #	SIZE	SPAN
690032	15.95	4x4" 7"
690030	13.95	3x3" 6"
690020	13.95	2x2" 4"

BOW ROLLERS



PART #	SIZE	SHAFT
690036	7.95	4" 1/2"
690035	5.95	2x2" 4"

ROCKER & RIB ROLLERS

RIBBED PART #	LENGTH	DIA.	SHAFT
690158	11.95	3"	5" 5/8"
690155	11.95	3"	5" 3/4"
690154	11.95	3"	4-3/8" 5/8"
690153	11.95	3"	4-3/8" 3/4"

PLAIN PART #	DIA.	SHAFT
690150	15.95	4-3/8" 4" 3/4"



END CAPS FOR BOW, SPOOL, KEEL AND SIDE GUIDE ROLLERS

PART #	LENGTH	DIA.	SHAFT
690168	5.95	1-1/4"	3-1/2" 5/8"
690167	4.95	1-1/4"	3" 1/2"
690165	4.95	1-3/4"	2-1/2" 5/8"
690160	4.95	1-3/4"	2-1/2" 1/2"

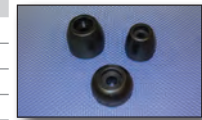
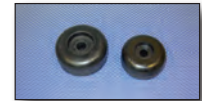

THERMAL PLASTIC RUBBER (TPR) ROLLERS

TPR HEAVY DUTY KEEL ROLLERS



PART #	LENGTH	DIA.	SHAFT
690212	25.95	12"	3-1/2" 5/8"
690208	22.95	8"	3-1/2" 5/8"

TPR SPOOL ROLLERS



PART #	LENGTH	DIA.	SHAFT
690205	11.95	5"	3" 5/8"
690204	10.95	4"	3" 5/8"
690202	10.95	4"	3" 1/2"

TPR BOW ROLLERS



PART #	LENGTH	DIA.	SHAFT
690224	7.95	4"	3-1/2" 1/2"
690222	6.95	3"	3" 1/2"

TPR RIB ROLLERS



PART #	LENGTH	DIA.	SHAFT
690218	13.95	5"	3" 1"
690216	11.95	5"	3" 3/4"

TPR BOW BELLS

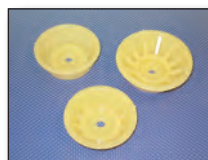

3-1/2"

PART #	SIZE
690210	6.95 1/2"

TPR END CAPS FOR BOW, SPOOL AND KEEL ROLLERS



3-1/2" x 1-1/4"

PART #	SIZE
690211	4.95 1/2"

TPR KEEL PADS



12" Pad, Side Hole

PART #	SIZE
690200	8.95

tires & wheels
axles, hubs & springs
tongue accessories
hitches
electrical
brake parts
trailer hardware
locks & pins
towing & loading
tie downs
tools
chemicals

TRAILER

TOWING & LOADING

ON THIS PAGE ARE THE NECESSARY PARTS TO MAKE YOUR OWN CUSTOM ROLLER KIT. ALL YOU DO IS PICK A BRACKET, A SHAFT AND TWO PAL NUTS. FIND THE CORRECT SIZE ROLLER ON THE FOLLOWING PAGES AND ASSEMBLE THE PERFECT SIZE.

tires & wheels
axles, hubs & springs
tongue accessories
hitches
electrical
brake parts
trailer hardware
locks & pins
towing & loading
tie downs
tools
chemicals

ONE-PIECE KEEL ROLLER BRACKETS



- Heavy duty one piece brackets
- which mount to cross member to hold roller
- For 5/8" shaft with 17/32" x 5" lot
- for adjustment
- 11 gauge steel
- Galvanized finish

PART #	ROLLER	SLOT CNTR.
CS10301 21.79	5"	3"
CS10303 26.93	8"	6"
CS10304 29.51	10"	8"
CS10305 30.80	12"	10"

SPLIT TWO-PIECE KEEL ROLLER BRACKETS

- Two piece brackets to accommodate any length roller
- 17/32" x 5" slot for vertical adjustment
- adjustment
- 11 gauge steel
- Zinc plated - 5/8" shaft
- Sold in pairs only

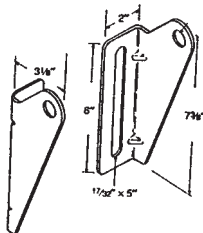

PART # CS10500 21.78

ZINC PLATED ROLLER SHAFTS

- Sold each (bulk)



PART #	LENGTH	DIA.
CS10700 5.33	5-1/4"	1/2"
CS10701 6.27	6-1/4"	1/2"
CS10704 1.95	4-5/8"	1/2"
CS10705 13.47	12-3/4"	1/2"
CS10721 10.76	5-1/4"	5/8"
CS10722 8.03	6-1/4"	5/8"
CS10725 7.67	9-1/4"	5/8"
CS10726 7.77	11-1/8"	5/8"
CS10727 11.54	13-1/2"	5/8"

PAL NUTS

- Zinc plated push on to secure
- rollers to shaft
- Push on metal cap
- 2 sizes
- Sold each (bulk)

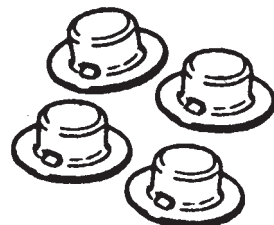

PART #	SIZE
690188 1.35	1/2"
690190 0.95	5/8"

VERTICAL BUNK BRACKETS

- Galvanized bracket will adjust vertically to hold 2" bunks on edge
- Width: 2", double slots



8-1/2" long

PART #	EACH SLOT
CS10604 11.51	7/16" x 2-1/2"

ADJUSTABLE BUNK BRACKETS

- Zinc plated
- Heavy gauge steel brackets mount 2" bunks on edge
- Slotted vertical adjustment to standard or deep V-hulls
- Width: 2"
- Slot 17/32"

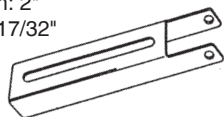

PART #	LENGTH	EACH SLOT
CS10600 12.28	9-1/2"	7/16" x 6"
CS10601 15.36	12-5/8"	17/32" x 9-1/8"

BOLSTER/SWIVEL BRACKET ASSEMBLIES

- 2-1/2" width
- Bunk mount holes 2-1/2" on center



PART #	ASSEM. LENGTH	SLOT	CTN
CS10000 14.08	9"	2-3/4"	48
CS10001 20.51	11"	3-3/4"	36
CS10002 23.06	13"	4-3/4"	36

STATIONARY BUNK BRACKETS

- Zinc Plated
- U-brackets mount on top of trailer cross members to hold 2" x 4" bunks on edge
- Made of 10 gauge steel

1-1/2" wide

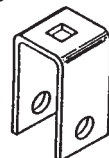

PART #	HEIGHT	BOARD SIZE
CS28104 3.95	2-1/4"	2 x 4

ROLLER BUNK MOUNTING BRACKET

- Galvanized swivel top bracket provides vertical and tilting adjustment for roller bunks
- Mount on trailer cross member
- Non-slip dimples for security
- Pair of bunks requires at least 4 brackets
- Slots: 17/32" x 3-3/4"
- Width: 2-1/2"
- Assembled length: 11"



PART #	DESCRIPTION
CS10003 29.50	Assembled bracket, bulk
CS10101 12.81	Bracket only



TAILLIGHT BRACKETS

- Galvanized brackets to hold trailer side rail
- Punched to hold lights and wiring

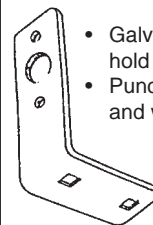

CS26057 5.09

BOLSTER SUPPORT BRACKETS

- Zinc plated
- Heavy 11 gauge steel with double slot for vertical adjustment
- Non-slip dimples for better hold
- Width: 2-1/2"
- Slot Width: 17/32"

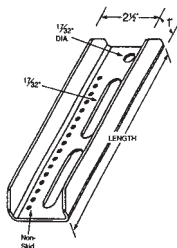

PART #	LENGTH	EACH SLOT
CS10100 8.91	9"	2-3/4"
CS10101 12.81	11"	3-3/4"
CS10102 15.38	13"	4-3/4"

SWIVEL/BOLSTER BRACKET

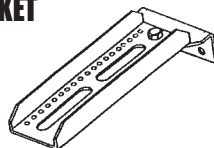

TO CREATE THE ABOVE ORDER ONE OF EACH AND SIMPLY BOLT THE ANGLE BRACKET TO THE SUPPORT BRACKET.



SWIVEL ANGLE BRACKET

- Zinc plated
- For use with bolster brackets to secure tie downs

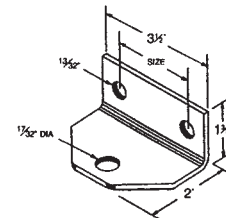

PART #	HOLE CENTERS
CS10200 5.11	2-1/2" on center
CS10201 5.11	2" on center



BOAT GUIDES TRAILER POSITIONERS

For quick, easy boat centering, in and out of the water • Ideal for boat lifts and trailers

- Simple design - no moving parts to corrode, hang up or damage your boat • Fully adjustable for all popular trailers • Easy installation - no drilling required • Non-marring white finish for high visibility • Extra long mounting hardware fits all popular trailers and boat lifts • Trailer lights can be kept out of the water by attaching boat guides

Boat Guides' Extra Height Improves Visibility When Launching or Backing Up

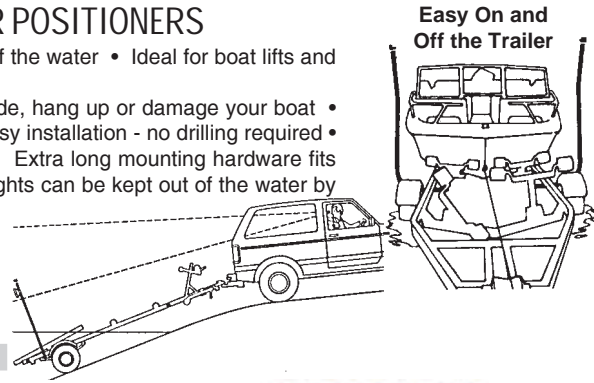

Easy On and Off the Trailer

PART #	DESCRIPTION
FT158 171.14	44" Boat Guides with Hardware - Boxed for Display
FT160 181.08	50" Boat Guides with Hardware - Boxed for Display

FULTON

ROLLER BUNKS

- Change bunk trailers to roller type
- Channel-style bunks pre-assembled
- Pair supports up to 1,500 lbs.
- Made of heavy gauge galvanized steel for long lasting rust protection
- Mount on existing flat bunkboards, or used with our special mounting brackets (sold separately) for height and angle adjustment
- No hardware is included
- Channel: 2-1/8" W x 2-1/2" H

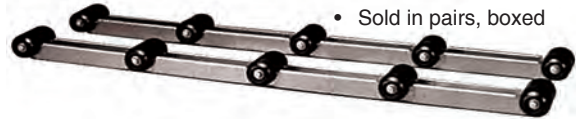

• Sold in pairs, boxed

PART #	LENGTH	ROLLERS
CS27700 260.40	4'	5
CS27710 290.58	5'	6

HEAVY DUTY CARPETED BUNK BOARDS

- Marine grade 2" X 4" bunks covered with top quality, weather-resistant marine carpet (black) to protect hulls from scratching when launching, loading or trailering
- Long-lasting black carpet has minimal water retention, durable backing

PART #	LENGTH
CS27800 61.49	3 Ft.
CS27810 75.89	4 Ft.
CS27820 92.27	5 Ft.



• Sold in pairs



REPLACEMENT CARPET

- Deluxe, high quality, weather-resistant carpet renews trailer bunk appearance and protects boats from scratches
- Durable backing with minimal water retention
- Width of 10" will completely surround 2" X 4" bunk
- Black only

CS11330 38.80	11" x 12 Ft.	Boxed
---------------	--------------	-------



MOST TRAILER MANUFACTURERS USE GRADE 5 SCREWS AND BOLTS FOR MAXIMUM SAFETY AND SECURITY. GRADE 5 HARDWARE HAS A HIGHER TENSILE STRENGTH THAN THE GRADE 2 HARDWARE USUALLY FOUND IN HARDWARE STORES.

HEX HEAD BOLTS

- Packs of 4 bolts, washers and nuts
- Zinc plated steel, grade 5
- Used to mount tongue to trailer frame



PART #	SIZE
CS10921 0.99	7/16" - 14 x 1"

HEX HEAD BOLTS

- Packs of 4 bolts, washers and nuts
- Zinc plated steel, grade 5
- Can be used to mount brackets, coupler and winch stands



PART #	SIZE
CS11035 1.50	3/8" - 16 x 3"

3/8" - 16 SLOTTED TRUSS HEAD BOLTS

- Display packages of 4 bolts, washers and nuts
- Zinc plated steel, grade 2
- Can be used to mount fenders to fender brackets



PART #	SIZE
CS10941 3.75	3/8" - 16 x 3/4"

FAST SAME DAY SHIPPING

TRAILER CATALOG 203

tires & wheels
axles, hubs & springs
tongue accessories
hitches
electrical
brake parts
trailer hardware
locks & pins
towing & loading
tie downs
tools
chemicals

TRAILER

TOWING & LOADING

BUNK BOARD GUIDE-ON

BLACK CARPET INSTALLED

Carpeted bunkboards provide proper center loading in wind or side current conditions • 2" x 4" x 5 Ft. boards tilt and are covered with high grade marine carpet • Distance between galvanized upright posts can be adjusted to fit trailer • Can be mounted on top of frame for extra height • Complete in display box • Height: 21" • Adjust: out to 13" each side • Fits: Frame up to 3" W x 4-1/4" H • Tube: 1-1/2" sq. 16 ga. • Matl: Pre-galvanized steel • Angle: 75°

CS27600 316.75 Sold Per Pair Boxed

SHORT BUNK STYLE BOAT GUIDE-ON

BLACK CARPET INSTALLED

Same solid construction as our larger model • Bunk is 24" long, covered with deluxe marine carpet, and mounted with an extra strong adjustable bracket • Can be mounted on top of frame for extra height • Complete in display box • Height: 21" • Adjust: out to 13" each side • Fits: Frame up to 3" W x 4-1/4" H • Tube: 1-1/2" sq. 16 ga. Matl: Pre-galvanized steel • Angle: 75°

CS27660 182.24 Sold Per Pair Boxed

FOR BOTH STYLES
Use kit #CS11416 longer u-bolts for frames up to 3" x 5-1/4"
Use kit #CS27630 for raised mounting of tail lights



JON BOAT FRONT SUPPORT BUNK

BLACK CARPET INSTALLED

Carpeted 2" x 24" bunk cushions and supports front of jon boat or other flat bottom boat • Adjusts from 5-1/2" to 8" above tongue • Place on tongue at proper length for boat • Brackets are hot dipped galvanized • Complete with mounting hardware for 2" or 3" tongue



CS27850 78.63 Sold Per Pair Boxed

LONGER U-BOLT KIT

FOR FRAMES UP TO 3" WIDE X 5-1/4" HEIGHT

- Longer u-bolts to mount all styles of boat guides on taller trailer frames up to 5-1/4" in height
- Leg length is 6" with thread length of 2"
- 5' bunkboard style guide-on requires 2 sets, all other guide-ons require 1 set



CS11416 31.04 Sold Per Kit Set of 4 U-bolts

ROLLER GUIDE-ON

ROLLERS ALREADY PRE-ASSEMBLED TO POSTS

Makes boat loading easier • Galvanized posts are pre-assembled with 9" roller and end caps • Can be mounted on top of frame for extra height • Complete in display box • Height: 21" • Adjust: out to 13" each side • Fits: frame up to 3" W x 4-1/4" H • Post: 1-1/2" sq. 16 ga. • Matl: pre-galvanized steel • Angle: 90°

CS27610 191.84 Sold Per Pair



REPLACEMENT PARTS

PART #		DESCRIPTION	MEASUREMENTS
690126	9.95	Roller	2" x 9"
690160	4.95	End Cap	2" x 1-3/4"
CS10705	13.47	Shaft	1/2" x 12-3/4"
690188	1.35	Cap Nut	1/2"

GUIDE-ON LIGHT BRACKETS

FOR 40" AND 60" POST STYLE

- Mounts lights out from PVC post approx. 7-1/2"
- Includes 2 formed galvanized brackets, 2 pieces of color coded 3-conductor bonded wire, 8 ft. length each, 4 terminals and 4 butt connectors plus hardware for mounting to PVC posts (does not include lights)

CS27650 48.95 Sold Per Kit

FOR BUNKBOARD, SHORT BUNK, AND ROLLER STYLE

- Mount tail lights high and dry
- Includes 2 2-3/4" x 6" galvanized brackets plus hardware for mounting to pre-punched boat guide-on upright posts (does not include lights or wiring)

CS27630 27.95 Sold Per Kit

TOP LIGHT KIT FOR POST STYLE BOAT GUIDES - LED

FITS INSIDE 2" PVC PIPE



- Add a pair of these amber and red lamps on top of your existing post guide-ons and see your trailer's position clearly as you back up



PART # DESCRIPTION
CS27656A 60.85 LED Top Light Kit For Post Guides, Packaged

TRAILER



AUTOMATIC
DISTRIBUTORS

TRAILER CATALOG

TIE DOWNS

TIE DOWNS

ANCRA TIE DOWNS

CLASSIC BLACK TIE DOWNS

- 1" x 5-1/2'
- Like the Original Red, this tie down has been a top seller for years
- Ancra's 'Black' strap is engineered to last with weather and abrasion resistant one inch wide nylon webbing
- It comes with vinyl coated end hooks and fasteners
- Loop end strap for a better grip
- It also has a pressure plate cam buckle
- 1,200 lbs. straight tension and 2,400 lbs. looped tension
- One pair per package



COLOR	U/M	MFG #	PART #	
BLACK	PR	40888-26	AN408826	40.00

ATV QUAD PAK

- 1" x 5-1/2'
- 4 pack of Ancra's Original Reds and Rat Pak for securing larger motorcycles and atvs
- Webbing - 4,500 lb. tensile strength nylon
- Buckle - 4,400 lb. rated 1" ratchet buckle and 1,800 lb. rated cam buckle with pressure plate
- Hooks - 2 ea. 1,200 lb. rated vinyl coated hooks on each original red and 1 ea. vinyl coated hook and 1 ea. plated hook on each rat pak strap
- Overall length length - 66"
- Minimum assembly strength - 1,200 lb. per strap
- Working load capacity - 400 lb. per strap
- Packaged in 4 strap sets of 2 each
- 1,200 lbs. straight tension and 2,400 lbs looped tension

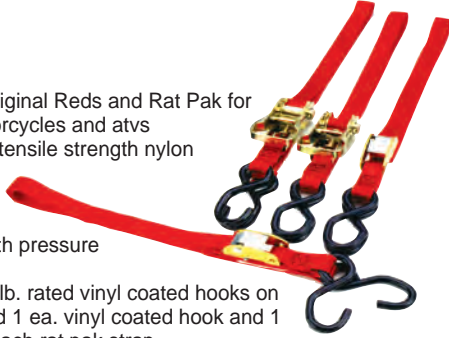

COLOR	U/M	MFG #	PART #	
RED	PR	45211-10	AN452110	106.35

12" SOFT HOOK EXTENSIONS

- Ancra's soft-hook offers the best protection when transporting
- The one inch black nylon webbing acts as a tie down extension or loops around the handlebars or rear seat rails, eliminating hard contact of steel hooks
- Assembly strength of each soft hook is 3,000 lbs.
- Packaged in pairs



COLOR	U/M	MFG #	PART #	
BLACK	PR	45214-14	AN459211	9.59

ATV RAT PAK

- 1" x 5-1/2'
- 1" ratchet
- Buckle version of the Original tie down
- Webbing - 4,500 lb. tensile strength nylon
- Buckle - 4,400 lb. rated 1" ratchet buckle
- Hooks - 2 ea. 1,200 lb. rated vinyl "S" hooks (1 vinyl coated, 1 plated) per strap
- Working load capacity - 400 lb. per strap
- Minimum assembly strength - 1,200 lb. per strap
- Packaged in pairs



COLOR	U/M	MFG #	PART #	
RED	PR	47439-10	AN473910	46.10

13' GENERAL PURPOSE RED TIE DOWN

- Longer version of the Ancra Originals
- Webbing - 4,500 lb. tensile strength nylon
- Buckle - 1,800 lb. rated heavy duty cam buckle with pressure plate
- Hooks - 2 ea. 1,200 lb. rated vinyl coated "S" hooks per strap
- Overall length - 13" with sewn hand loop
- Minimum assembly strength - 1,200 lb. per strap
- Working load capacity - 400 lb. per strap
- All components are made in the USA



COLOR	U/M	MFG #	PART #	
RED	EA	40888-25	AN408825	33.57

TRAILER

ERICKSON TIE DOWNS

RATCHETING TIE DOWN STRAPS

- 1" x 10' light duty ratchet straps
- 900 lb. rated
- Red
- 4-pack



COLOR	MFG #	U/M	PART #	
RED	01418	SET OF 4	266003	33.95

4 PACK CAMO RATCHET STRAPS

- 1" x 10' ratchet straps
- 900 lb. capacity
- Heat treated vinyl coated hooks
- Camo webbing
- 4-pack



COLOR	MFG #	U/M	PART #	
CAMO	01419	SET OF 4	EK1419	41.95

RUBBER HANDLE RATCHETING TIE DOWNS

- 1" x 10' ratchet straps
- 1,200 lb. rated
- Fully rubberized handle and thumb release
- 4-pack



COLOR	MFG #	U/M	PART #	
BLUE	01415	SET OF 4	EK1415	35.95

ERICKSON TIE DOWNS



RETRACTABLE RATCHETING TIE DOWN STRAPS - 1" X 6'

- 1" x 6' re-tractable ratcheting tie downs
- 1,500 lb. maximum load capacity (500 lb. working load limit)
- Simple to operate - to release, push down on red release button
- Automatically rewinds
- The unused web is stored in the center housing so have no excess web blowing in the wind
- Weather proof strap stays clean and dry

COLOR	U/M	MFG #	PART #	
BLACK	PR	34413	EK34413	43.95



RETRACTABLE RATCHETING TIE DOWN STRAPS - 2" X 6'

- 2" x 6' re-tractable ratcheting tie downs
- 4,000 lb. maximum load capacity (1,333 lb. working load of limit)
- Simple to operate - to release, push down on red release button
- Automatically rewinds
- The unused web is stored in the center housing so have no excess web blowing in the wind
- Weather proof strap stays clean and dry

COLOR	U/M	MFG #	PART #	
BLACK	PR	34414	EK34414	75.95



RETRACTABLE TIE DOWN STRAPS - 1" X 10'

- 1" x 10' re-tractable ratcheting tie downs
- 1,200 lb. maximum load capacity (400 lb. working load limit)
- Simple to operate - to release, push down on red release button
- Automatically rewinds
- The unused web is stored in the center housing so have no excess web blowing in the wind
- Weather proof strap stays clean and dry

COLOR	U/M	MFG #	PART #	
BLACK	PR	34415	266015	46.95
BLACK	EA	54415	266016	27.95

DELUXE RUBBER HANDLE RATCHETING TIE DOWNS

- 1" x 6' ratcheting tie downs
- 2,000 lb. maximum load capacity
- Deluxe rubber handle ratchet
- Red
- 4-pack



COLOR	U/M	MFG #	PART #	
RED	SET OF 4	05519	266005	60.95



RATCHETING TIE DOWNS

- 1" x 6' ratchet straps
- 1,200 lb. maximum load capacity
- Black
- 4-pack



COLOR	U/M	MFG #	PART #	
BLACK WITH RED TRACER	SET OF 4	05511	EK05511	34.95



SPORTSMAN ATV KITS

- 1" x 6' ratchet straps
- 2,000 lb. maximum load capacity
- Blue
- 4-pack

COLOR	U/M	MFG #	PART #	
BLUE	SET OF 4	05513	266006	38.95

CAMO WEB

- Rubber handle ratchet and release with vinyl coated hooks
- 2" x 27' - 10,000#
- 3,300# working load limit
- Sold each (bulk)



COLOR	U/M	MFG #	PART #	
CAMO	EA	68655	EK68655	46.95

DELUXE RUBBER HANDLE RATCHET (LONG)

- 2" x 27' - 10,000#
- Long Handle
- Deluxe Molded Rubber Handle
- Vinyl Coated Double J-Hooks
- Velcro Strap Wrapper
- 10 per Display Box
- 24 cases per Pallet



COLOR	U/M	MFG #	PART #	
YELLOW	EA	69627	EK69627	47.95

tires & wheels

axles, hubs & springs

tongue accessories

hitches

electrical

brake parts

trailer hardware

locks & pins

towing & loading

tie downs

tools

chemicals

TRAILER

TIE DOWNS

ERICKSON TIE DOWNS

15' RATCHETING TIE DOWNS



- 1" x 15' ratchet tie downs
- Patented moulded rubber handles
- 1,200 lb. maximum load capacity (400 lb. working load limit)

COLOR	U/M	MFG #	PART #	
BLUE	SET OF 4	31415	266010	42.95
BLUE	PR	34400	EK34400	23.95

15' RATCHETING TIE DOWNS



- 1" x 15' ratchet tie downs
- 1,200 lb. maximum load capacity (400 lb. working load limit)
- High quality yellow chromate-plated ratchets

COLOR	U/M	MFG #	PART #	
RED	SET OF 4	31418	266008	40.95
RED	PR	34401	266009	21.95

15' RATCHETING TIE DOWNS



- 1" x 15' ratchet tie downs
- 2,000 lb. maximum load capacity (667 lb. working load limit)
- Wide handle with molded rubber makes tightening easy

COLOR	U/M	MFG #	PART #	
ORANGE	PR	34404	EK34404	33.95
ORANGE	SET OF 4	31416	266011	65.95

RATCHETING TIE DOWN WITH WEB CLAMP



Erickson's WEB CLAMP was designed to address the problem of what to do with excess webbing. The WEB CLAMP mechanism is much like a mouse trap, lift the spring loaded clamp and place the folded webbing under the clamp, release the spring loaded WEB CLAMP and you have trapped the excess web. Very simple and effective. SO NEAT!!



SIZE	MAX LOAD	SAFE WORKING LOAD	QTY	MFG #	PART #	
1" x 15'	1,500#	500#	1 pack	31350	EK31350	16.95
1" x 8'	1,500#	500#	2 pack	31351	EK31351	25.95
1" x 10'	1,500#	500#	4 pack	31352	EK31352	48.95

RATCHET STRAP W/DOUBLE FLOATING RING



- 1" x 15' – 3,000#
- Ratchet strap with double floating ring
- Black

COLOR	MFG #	U/M	PART #	
BLACK	01314	EA	266019	26.95

tires & wheels

axles, hubs & springs

tongue accessories

hitches

electrical

brake parts

trailer hardware

locks & pins

towing & loading

tie downs

tools

chemicals

TRAILER

RATCHETING TIE DOWNS



- 1.25" x 12' ratchet tie downs
- 2,500 lb. maximum load capacity (833 lb. working load limit)
- Long handle ratchet with moulded rubber handles
- Allows ease in operation
- Strong silver polyester web

COLOR	U/M	MFG #	PART #	
GRAY	SET OF 4	34411	266012	75.95
GRAY	PR	34412	266013	38.95

ERICKSON TIE DOWNS

RATCHET STRAPS



- 2" x 15' heavy duty ratchet strap
- 5,000 lb. maximum load capacity (1,650 lb. working load limit)
- Heavy duty double "J" hooks
- Ratchet action
- Yellow

COLOR	SIZE	U/M	MFG #	PART #	
YELLOW	2" x 15'	EA	02300	EK2300	42.95
YELLOW	2" x 25'	EA	02400	EK2400	44.95



SPORTSMAN TIE DOWN STRAPS

- 1" x 6'
- 2,000 lb. rated
- TCS buckle straps
- Over center lock buckle has no teeth to damage the web
- Simply attach your hooks and pull loose ends through the buckle, flip handle down and lock into safety tab
- Hunter orange
- 4-pack

COLOR	U/M	MFG #	PART #	
HUNTER ORANGE	SET OF 4	05740	266001	45.95



COMBO PACK

- (2) 1" x 10' - 1,200# ratchets
- (2) 1" x 6' - 900# cam straps
- 4 pack
- Blue and red

COLOR	U/M	MFG #	PART #	
RED, BLUE	SET OF 4	05606	266002	34.95



TCS BUCKLE

- 1" x 5' - 1,200#
- Security lock buckles, 3 pack
- Camo



COLOR	U/M	MFG #	PART #	
CAMO	SET OF 3	05726	EK5726	29.95



ATV TIE DOWN STRAPS

- 1" x 5' cam buckle tie down straps
- 750 lb. maximum load capacity
- Cam buckles
- Black
- 3-pack

COLOR	U/M	MFG #	PART #	
RED	SET OF 3	06300	EK06300	31.95



CAM BUCKLE TIE DOWNS

- 1" x 5.5' cam buckle tie downs
- 900 lb. maximum load capacity
- Quick lock cam buckles
- Heat treated vinyl coated hooks
- 4-pack

COLOR	U/M	MFG #	PART #	
RED	SET OF 4	05605	EK5605	36.95

CAM LOCK TIE DOWNS



- 1" x 6' cam lock tie downs
- 1,200 lb. maximum load capacity (400 lb. working load limit)
- Features the traditional pull and lock cam buckles
- Blue

COLOR	U/M	MFG #	PART #	
BLUE	PR	34403	EK34403	21.95
BLUE	SET OF 4	35605	266014	39.95

tires & wheels

axles, hubs & springs

tongue accessories

hitches

electrical

brake parts

trailer hardware

locks & pins

towing & loading

tie downs

tools

chemicals

TRAILER

TIE DOWNS

ERICKSON TIE DOWNS

- tires & wheels
- axles, hubs & springs
- tongue accessories
- hitches
- electrical
- brake parts
- trailer hardware
- locks & pins
- towing & loading
- tie downs
- tools
- chemicals

TRAILER

RECOVERY STRAP

- 1" x 15'
- 7,500 lb. breaking strength
- 3,750 lb. maximum vehicle weight
- Includes storage bag



COLOR	MFG #	U/M	PART #
WHITE	59350	EA	266028 32.95

TOW STRAP

- 2" x 15' heavy duty tow strap with forged hooks
- Blue polyester web
- 8,500 lb. maximum load capacity
- 4250 maximum vehicle weight



COLOR	MFG #	U/M	PART #
BLUE	34405	EA	EK34405 24.95

TOW ROPE

- 7/8" x 14' tow rope
- 8,500 lb. breaking strength
- 4,200 lb. maximum vehicle weight
- Includes storage bag



COLOR	MFG #	U/M	PART #
BLUE	09102	EA	EK9102 27.95

TOW STRAP WITH FORGED SAFETY SNAP HOOK

- 2" x 20' tow strap
- 10,000 lb. breaking strength
- 5,000 lb. maximum vehicle weight
- Forged safety snap hook

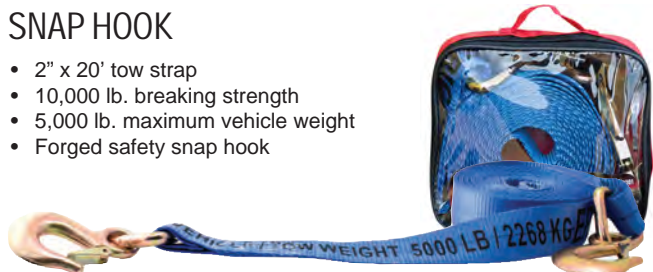

COLOR	U/M	MFG #	PART #
BLUE	EA	09301	266029 53.95

TOW ROPE

- 1/2" x 14' tow rope
- 2,000 lb. breaking strength
- 1,000 lb. maximum vehicle weight
- Includes storage bag



COLOR	MFG #	U/M	PART #
YELLOW	09103	EA	EK9103 22.95

RATCHETING LOGISTIC STRAPS

- 2" x 20' - 3,500#
- Ratchet logistic strap, bulk
- Blue



COLOR	MFG #	U/M	PART #
BLUE	59140	EA	266026 23.95

AXLE STRAP

- 2" x 24" - 5,000#
- Axle strap, bulk
- Blue



COLOR	U/M	MFG #	PART #
BLUE	EA	58506	266027 8.95

IN BOARD/OUT BOARD TRANSOM TIE-DOWNS

- 2" x 4' - 1,200#
- Over-center lock buckle
- 2 pack



COLOR	U/M	MFG #	PART #
BLACK	PR	06100	266032 27.95

ERICKSON TIE DOWNS



STANDARD BUNGEE 2-PACK

- 2 pack

SIZE	MFG #	PART #	
13"	06645	EK6645	6.95
18"	06646	EK6646	6.95
24"	06647	EK6647	6.95
30"	06648	EK6648	8.95
36"	06649	EK6649	10.95

FLAT BUNGEE



A hardened metal wire form is placed in the center of the molded polycarbonate hook making it super strong.

SIZE	MFG #	PART #	
12"	06912	EK06912	3.95
18"	06918	EK06918	6.95
24"	06924	EK06924	6.95
30"	06930	EK06930	6.95
36"	06936	EK06936	6.95
42"	06942	EK06942	7.95

DELUXE BUNGEE



- Talk about quality! That's what the deluxe bungee is all about
- An Industrial grade bungee comes secured to a molded polycarbonate hook with a hardened wire insert molded in
- 3 sizes available in 3 colors

SIZE	COLOR	MFG #	PART #	
12"	RED	07012	EK07012	2.95
24"	BLUE	07024	EK07024	6.95
36"	YELLOW	07036	EK07036	6.95

STRAP HANGER

- Strap hanger, bulk
- Black



COLOR	U/M	PART #	
BLACK	EA	266007	15.95

ASSIST STRAPS

- 1" x 18" - 2,000#
- 2-pack



COLOR	U/M	MFG #	PART #	
BLACK	PR	06303	266017	6.95
RED	PR	06304	266018	6.95



ADJUSTABLE TIRE STRAP W/RATCHET

- 10,000 lb.
- Adjustable tire strap, 1 pack
- Short swivel j-hook adds ease when operating in tight corners
- Yellow

COLOR	U/M	MFG #	PART #	
YELLOW	EA	08522	EK08522	63.95

tires & wheels

axles, hubs & springs

tongue accessories

hitches

electrical

brake parts

trailer hardware

locks & pins

towing & loading

tie downs

tools

chemicals

TRAILER

ERICKSON TIE DOWNS

12 PACK JAR ASSORTMENT



- Solid colors
- 4 - 10" x 4mm
- 2 - 18" x 8mm
- 2 - 24" x 8mm
- 2 - 30" x 9mm
- 2 - 36" x 10mm

MFG #	U/M	PART #	
06621	EA	EK6621	20.95

25 PACK JAR BUNGEE ASSORTMENT



- Bright red, blue, green, and yellow
- 6 - 10" x 4mm
- 5 - 13" x 8mm
- 5 - 18" x 8mm
- 5 - 24" x 8mm
- 2 - 30" x 9mm
- 2 - 36" x 10mm

MFG #	U/M	PART #	
06622	EA	EK6622	34.95

16-PIECE STRAP PACK



- (2) 1" x 15' - 500 lb. Rubber Handle Ratchet Straps
- (1) 1" x 10' - 300 lb. Cam Strap
- (1) 1" x 10' Utility Strap
- (2) 1" x 6' Handy Straps
- Deluxe Bungee Cords 2 ea. 18", 24", 36"
- (4) Mini Bungee Cords



MFG #	U/M	PART #	
03000	EA	266004	57.95

10" MINI BUNGEE 4-PACK



- 10"
- 4 pack

U/M	PART #	
SET OF 4	EK6699	3.95

RUBBER TARP STRAP 10 PACK



These rubber bungee cords are a versatile tie down strap and are easily stored. These rubber straps have a 2" S-Hook on each end.

Package of 10 includes:

- (4) - 9"
- (2) - 15"
- (2) - 21"
- (2) - 31"

MFG #	U/M	PART #	
06610	EA	EK06610	20.95



12" CHROME PROTECTOR

- Fits 1" to 2" webbing
- 100% polyester/ simulated sheepskin
- 1 pack

MFG #	U/M	PART #	
06305	EA	266044	6.95

TRANSOM/BOW EYE

- Stainless steel
- 3/8" x 3" threaded rod
- Nuts and washers included
- Sold each, bulk



MFG #	COLOR	U/M	PART #	
53909	STEEL	EA	266034	11.95

LEVER ACTION - INDUSTRIAL CARGO BARS



MFG #	DESC.	U/M	PART #	
08906	88" - 103"	EA	EK8906	74.95
08907	60" - 75"	EA	EK8907	70.95

10,000 LB. MINI WINCH

- 2" - 10,000#
- Sold each, bulk



MFG #	U/M	PART #	
52804	EA	266021	29.95

TIGHTENING BAR

- 10"
- Sold each



MFG #	U/M	PART #	
52802	EA	266024	6.95

WEB PROTECTOR

- Sold each, bulk



MFG #	COLOR	U/M	PART #	
59708	WHITE	EA	266025	3.95

TRAILER



TITAN RATCHET TIE DOWNS

- Ratchet tie downs provide super strong holding power & precise tension adjustment
- Stylish Cast Handle Steel handle with padded grip
- Easy to reach release button

DESCRIPTION	DUTY RATING	LOAD CAPACITY	BREAK STRENGTH	COLOR	MFG #	PART #	
TITAN RATCHET TIE DOWN 1" x 14' (SINGLE)	STD	600	1800	BLACK	1157100	444215	21.44



RETRACTABLE TRANSOM TIE DOWNS

- Retractable Transom Ratchets
- Strap retracts for easy storage and no tangling
- Easy bolt on function (Hardware included)
- Some models available with stainless steel housing

DESCRIPTION	DUTY RATING	LOAD CAPACITY	BREAK STRENGTH	COLOR	MFG #	PART #	
RETRACTABLE TIE DOWN - (TRANSOM) 2" x 43" ZINC (SINGLE)	HEAVY	833	2500	BLACK	2061766	444229	49.50
RETRACTABLE TIE DOWN - (TRANSOM) 2" x 43" ZINC (2-PACK)	HEAVY	833	2500	BLACK	2060366	444230	123.86



RATCHET TIE DOWNS

- Versatile ratchet tie downs
- Made of power web plus webbing with a 900 pound capacity
- Easy to use, just attach and pump the handle
- Ratchet tightens down with vise like gripping power
- Perfect for all your trailering needs

DESCRIPTION	DUTY RATING	LOAD CAPACITY	BREAK STRENGTH	COLOR	MFG #	PART #	
RATCHET TIE DOWN W/ HOOKS - 1" x 13' (Single)	LIGHT	300	900	RED	1170000	444244	13.55



RATCHET TIE DOWNS

DESCRIPTION	DUTY RATING	LOAD CAPACITY	BREAK STRENGTH	COLOR	MFG #	PART #	
Ratchet tie down - 1-1/2" x 15' (single)	SUPER	1830	5500	YELLOW	1151701	444253	34.57
Ratchet tie down w/ hooks 2" x 25' (single)	SUPER	3330	10000	YELLOW	1152500	444254	54.84



CAM BUCKLE TIE DOWN W/HOOKS

- Will not damage cargo
- Leverage doubles the hold down force of a cam buckle
- Great choice for motorcycle or ATV tie down

DESCRIPTION	DUTY RATING	LOAD CAPACITY	BREAK STRENGTH	MFG #	PART #	
CAM BUCKLE TIE DOWN W/ HOOKS - 1" x 12' (SINGLE)	STD	400	1200	1034400	444262	15.43



BUNGEE CORDS

- Coated steel hooks are 3X stronger than conventional hooks
- Won't bend, break, scratch or mar
- Engineered to withstand even the harshest outdoor elements

DESCRIPTION	MFG #	PART #	
12" TRIPLE STRENGTH BUNGEE BLUE	2902000	444272	4.40

DESCRIPTION	MFG #	PART #	
1 pc. BUNGEE 24"	9402400	444285	1.92



- tires & wheels
- axles, hubs & springs
- tongue accessories
- hitches
- electrical
- brake parts
- trailer hardware
- locks & pins
- towing & loading
- tie downs
- tools
- chemicals

TRAILER

TIE DOWNS

- tires & wheels
- axles, hubs & springs
- tongue accessories
- hitches
- electrical
- brake parts
- trailer hardware
- locks & pins
- towing & loading
- tie downs
- tools
- chemicals



RATCHET TIE DOWNS

- 1" x 12' - 1,800#
- Great for ATVs, snowmobiles, boats, campers, motorcycles, trucks, and more!
- Set of 4

COLOR	U/M	MFG #	PART #	
YELLOW	SET OF 4	RTD411218	BY411218	27.90



CAM BUCKLE TIE DOWNS

- 1" x 6' - 1,200#
- Great for ATVs, snowmobiles, boats, campers, motorcycles, trucks, and more!
- Set of 4

COLOR	U/M	MFG #	PART #	
YELLOW	SET OF 4	CBTD41612	BY41612	24.24

SPI TIE DOWNS

- (2 ea.) 1" x 5 1/2' - 2,000#
- 4 colors
- Packaged in pairs for display



COLOR	U/M	PART #	
BLACK	PR	622142	19.95
RED	PR	622146	19.95
BLUE	PR	622147	19.95

BLACK RUBBER TIE DOWNS

- Quick and easy, just hook and secure into place
- Extra heavy duty 3/4" flat rubber tie downs with heavy reinforced ends and heavy 2-1/2" steel hooks
- Maximum resistance to all weather conditions



LENGTH	PART #	
10"	LP13910	1.39
15"	LP13915	1.69
21"	LP13921	2.19
31"	LP13931	2.79
41"	LP13941	2.99



- The Rope Ratchet's construction lets you secure a wide variety of loads quickly and easily by simply attaching the two hooks and pulling the loose end of the rope to the secure tightness you need
- Never have to worry about stretching, snapping back, or loosening
- Load stays secure because the rope stays locked in place with every pull until you release it by pushing the convenient thumb lever

SIZE	LOAD LIMIT	U/M	MFG #	PART #	
1/4" x 8'	150#	EA	01800	EK01800	22.95
3/8" x 8'	250#	EA	01801	EK01801	32.95
1/2" x 12'	500#	EA	01805	EK01805	47.95



2 PIECE RATCHETING TIE DOWN - 1" X 15'



- 1" x 15' ratcheting tie downs
- Adjustable length from 4 feet to 15 feet
- 900 lb. breaking strength (300 lb. safe working load)
- 1" wide synthetic webbing
- Red
- 2 pack
- Display packaged

U/M	MFG #	PART #	
PR	W1424	W1424	13.95

4 PIECE CAMO RATCHETING TIE DOWN STRAP SET 1" X 15'



- (4 ea.) 1" x 15'
- 1,200 lb. breaking strength (500 lb. working load limit)
- Locking ratchets
- Heavy duty vinyl coated hooks
- Easy push button release
- Camo
- Display packaged

U/M	MFG #	PART #	
SET OF 4	W1440	W1440	36.95

HAND WINCH STRAP



- 2" x 20' - 10,000#
- Sold each, packaged

COLOR	U/M	PART #	
BLUE	EA	EK06410	28.95

HAND WINCH STRAP



- 2" x 25' - 3,300#
- Sold each, packaged

COLOR	U/M	PART #	
BLACK	EA	EK06404	24.95

TRAILER



AUTOMATIC
DISTRIBUTORS

TRAILER CATALOG

TOOLS

TOOLS

- tires & wheels
- axles, hubs & springs
- tongue accessories
- hitches
- electrical
- brake parts
- trailer hardware
- locks & pins
- towing & loading
- tie downs
- tools
- chemicals

TRAILER

MINI DIAL TIRE PRESSURE GAUGE

- 1 to 60 PSI range
- Measures 1 one pound increments
- 1" easy to read white face dial
- Proper tire maintenance saves money by improving fuel economy and reducing tire wear
- Ideal for cars, trucks, SUV's, bicycles and more



260069 6.95

DIGITAL TIRE PRESSURE GAUGE

- Backlit display and convenient lighted tip.
- Triple function display P.S.I., BAR, and KPa.
- Auto off feature: Automatically shuts off in 30 seconds when not in use



260070 15.95

12V COMPACT TIRE INFLATOR

- Plugs into 12-Volt Accessory Outlet
- Includes Two Nozzle Adapters and Sport Needle
- Great for Tires, Toys and Sporting Goods
- 18 in. Hose Length with Universal Valve Adapter
- 10 Ft. Power Cord
- Handy on/off switch
- Easy to read pressure gauge
- High output 250 PSI motor



260006 26.95

MINI TIRE INFLATOR

- 100 PSI high pressure air compressor inflates standard car tire in under 8 minutes
- Compact size for easy storage with convenient storage compartment.
- 9' power cord with fused 12V power plug
- 12V power cord plugs into vehicle power outlet
- Built in dial pressure gauge
- Accessories include sports ball needle, raft and toy inflator nozzles and Presta valve adapter
- 17.5" high pressure hose



260007 28.95

TIRE INFLATOR W/LED

- 100 PSI high pressure air compressor
- Large easy to read built in dial pressure gauge
- 3 Super bright LEDs for night time emergencies
- 15" high pressure hose with screw on chuck
- 10' power cord with fused 12V power plug
- 12V power cord plugs into vehicle power outlet
- Inflates standard car tire in under 4 minutes (Performance based upon 175/70 R13 tire to 30 PSI)
- Accessories include sports ball needle, raft and toy inflator nozzles and Presta valve adapter



260008 43.95

DIGITAL TIRE INFLATOR

- Measure tire pressure from 0-150psi, 20-1000 kpa
- Change digital readout between psi, kpa, bar and kg/cm2 with a push of a button
- Back-lit blue LCD display
- Includes 2 AAA batteries, 1/4" male inlet, and valve core tool
- Built-in bleed button for lowering pressure
- Accurate within 0.5 psi



260114 39.95

ATV TIRE GAUGE 0-8 PSI

- Pocket size (2 1/2") low pressure tire gauge
- Marked in 1/2 lb. increments, accurately measures tire pressure up to 8 lbs.



EM68508 25.95

ATV TIRE GAUGE 1-20 PSI

- Marked in 1/2 lb. increments and graduated from 1-20 lbs
- Has a four sided calibrated bar provided with an air release and an offset chuck



EM68520 6.95

TMV TIRE PRESSURE GAUGE GRAY

- Tire pressure gauge



631542 11.95

MOTION PRO PROFESSIONAL TIRE PRESSURE GAUGES

- Custom gauge faces in Motion Pro signature blue and black
- High quality liquid filled 2.5 in. dial gauge with bleeder vent at top
- Custom protective boot with vent hole access
- Accurate to plus/minus 1.5 percent of maximum gauge reading
- Anodized 6061-T6 body with pressure relief valve
- High pressure hose with dual swivels and brass ball type air chuck



DESCRIPTION	PART #	
0-30 PSI, MX & Off-Road	142193	109.99
0-60 PSI, Street	142316	109.99

HYDRAULIC BRAKE BLEEDER

- Provides a simple method of checking needle and seat pressure as well as impulse diaphragms, etc.



678143 14.50

MINI BLEEDERS

- Combines wrench and bleeder valve into one convenient and compact tool
- Bleeds brake systems and hydraulic clutch systems
- Internal check valve for fast easy bleeding
- Anodized billet aluminum handle with chromoly steel body
- Compact size for tight spaces
- High quality internal seal
- Multi position handle



DESCRIPTION	PART #	
8mm	143835	28.99
10mm	144149	28.99
11mm	144150	28.99

DELUXE COMPRESSION TESTER KIT

- Deluxe compression tester for gas engines
- 2-1/2" 300psi gauge with quick disconnect ends
- 5 threaded adapters to cover most gas engines
- Includes: 10mm, 12mm, 14mm, 16mm, and 18mm threaded adapters
- Includes the hard to find 16mm x 1.5 adapter
- Blow molded fitted storage case



260161 52.95

SYNCRO CARB TUNER

- Precise four channel vacuum indicator designed specifically for intake synchronization of engines with multiple carburetors or throttle bodies (max vacuum range 40cm Hg)
- New mercury-free design uses non toxic manometer fluid
- For use with any 2, 3 or 4 cylinder four stroke motorcycles
- Spill proof design means the tool can be stored in a horizontal or vertical position
- Rugged, impact resistant ABS enclosure with convenient storage area for adapters
- Includes manometer fluid, hoses, 5mm adapters, in-line restrictors and instructions
- Unaffected by barometric pressure changes
- Includes hang hook to clip onto the handlebars for easy use
- Easy to read scale for precise synchronization
- Rubber feet on enclosure bottom helps prevent sliding



678411 114.99

MOTION PRO AIR GAUGE HOLDER

- Aluminum Gauge holder designed for use with Motion Pro Professional and Digital Tire Gauges
- Magnet on back allows for quick mounting to any metal surface or can be used without magnet for permanent mounting
- Eye catching number plate graphics with space for personalized race numbers



142379 28.99



MICRO BLEEDERS

- Ultra-compact, low profile design is only 11 mm high installed
- Stainless steel body is stronger and will not corrode
- Easy to install, simply replace the OE bleeder screw with the Micro Bleeder
- Reduces harshness caused by air build-up
- Allows bleeding of air pressure without tools
- One of the easiest bolt-on upgrades you can make to your forks
- Kit includes two bleeder valves



DESCRIPTION	PART #	
M5x0.8 for Showa (Gold)	144190	14.99
M5x0.8 for KYB (Silver)	144194	14.99

tires & wheels

axles, hubs & springs

tongue accessories

hitches

electrical

brake parts

trailer hardware

locks & pins

towing & loading

tie downs

tools

chemicals

TRAILER

FAST SAME DAY SHIPPING

TRAILER CATALOG

217

TOOLS

- tires & wheels
- axles, hubs & springs
- tongue accessories
- hitches
- electrical
- brake parts
- trailer hardware
- locks & pins
- towing & loading
- tie downs
- tools
- chemicals

TRAILER

COUNTER SHAFT SEAL PULLER

- Safely removes counter shaft seals with an ID of 29 mm to 47 mm
- Works on off road, street and ATV engines
- Unique expansion mechanism ensures seal is pulled straight and will not damage engine cases during extraction
- The only puller designed specifically for counter shaft seals
- Durable steel construction



144381 64.99



CRANK SHAFT PULLER

- Precision tool used to install press-in crank shafts into an engine case
- Time saving method maintains crank shaft true during installation
- Universal steel nut adapter works on virtually all crankshafts
- 22mm and 40mm billet aluminum face plate adaptors ensure crankshaft is pulled perfectly straight into bearings
- Reversible pull stud with both M10x1.25 and M12x1.25 threads
- Eliminates the need for a shop press to install crankshaft
- Machined brass thrust washer for extra durability



144379 96.99



T-6 VALVE SPRING COMPRESSOR

- Quick release system presses straight against the retainer to eliminate side loading the valve and keepers
- Works on all motorcycle, ATV, UTV, and small engine cylinder heads
- Billet 6061 aluminum frame provides unmatched strength and stiffness and lower weight
- Fully adjustable top and bottom
- Aluminum lower adjuster will not damage or scratch valves
- Compatible with Motion Pro 08-0248 adapters
- Includes universal fork style tip
- Durable blue anodized finish with laser engraved markings
- Simple, fast, and easy to use



144382 134.99

CARBURETOR POCKET TUNER

- Pocket size calculator used to determine required jetting changes in carburetors due to changes in temperature and altitude

MK550 7.20



CARBURETOR LEAK DETECTOR

- Provides a simple method of checking needle and seat pressure as well as impulse diaphragms, etc.

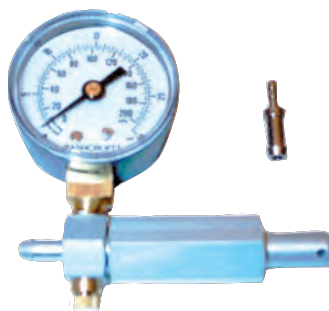

LD1075 85.95

CARBURETOR VACUUM SYNCHRONIZER

- This precision instrument gives mechanics and techs a visual method of balancing carburetors with a high degree of accuracy

FOR BALANCING MULTIPLE CARBURETORS

ED4027 60.95



100 AMP BATTERY LOAD TESTER

- Accurately test the condition of your battery and charging systems
- Performs both a voltage test and 15-second battery-load test
- 100-amp capacity
- Reliable and highly accurate, works on both 6- and 12-volt batteries
- Extra heavy leads with strain relief and color-coded, insulated, copper plated steel clamps



260133 46.95

BATTERY ALTERNATOR TESTER

- Easy to use battery / alternator tester
- Plug in to the 12V cigarette lighter in your car, the LED indicators will show you the status of your battery and alternator
- 3 LED indicators to show the battery condition: weak, normal or strong
- 3 LED indicators to check the status of the alternator voltage: low, normal or high
- Works on any 12 volt system, compact design for easy storage
- Compact size, a handy item for your glove box so you know right away if the problem you have is related to the battery or alternator



260134 14.95

BATTERY/ALTERNATOR VOLTAGE CHECKER

- For all 12 volt systems
- Easy to read LED lights
- Shows battery state-of-charge and level of alternator output



W2980 10.95

POCKET MULTI-TESTER

- Tests AC and DC circuits
- Volt and ohm analyzer
- Includes batteries and instructions



W2979 14.95

DIGITAL MULTI TESTER

- Features AC and DC volt measurement, DC current measurement, resistance measurement, diode test and Ohms
- LCD, on/off switch and two 32" test leads
- Low battery and over range indicators



- Automatic zero adjust
- 9V battery included



W2974 12.95

BATTERY JUMPER CABLE SET



- 64" long
- 10 gauge
- Color coded terminal
- Clamps for safe and secure handling
- Display packaged

EM96300 20.95



JUMPER CABLES

- Easy to use, easy to store
- Convenient storage bag
- Heavy duty, 8 ft., 8-gauge cables won't stiffen or freeze
- Tangle resistant, encased rubber grips for safer use



920-228 32.95

- tires & wheels
- axles, hubs & springs
- tongue accessories
- hitches
- electrical
- brake parts
- trailer hardware
- locks & pins
- towing & loading
- tie downs
- tools
- chemicals

TRAILER

- tires & wheels
- axles, hubs & springs
- tongue accessories
- hitches
- electrical
- brake parts
- trailer hardware
- locks & pins
- towing & loading
- tie downs
- tools
- chemicals

TRAILER

ECONOMY IGNITION TESTER

An easy to use, time saving piece of shop equipment



1754 6.88

SPARK PLUG WIRE TESTER

- Identifies damaged spark plug wire easily by moving tool along wire towards spark plug
- Tester light flashes in sync with spark plug firing until it runs across a break in wire



W80530 8.95

IGNITION/SPARK PLUG TESTER

- Checks the integrity of the electrical ignition and magneto/coil ignition systems of lawn mowers, boat motors, motorcycles and automobiles
- Checks both current and voltage and will indicate fouled electrodes
- E-Z view LED and neon lamps for easy accurate reading, pocket size



7731 10.95

BATTERY TERMINAL CLEANER

- All metal construction
- Quality stainless steel brushes
- Cleans both battery post and terminals



W147 4.95



DEGREE WHEEL

- Manufactured from .052 in. thick aluminum with a 6 3/4" outside diameter and a 6mm center hole
- Black anodized finish with easy to read numbers
- Check or set ignition and/or cam timing
- May be used on 2 & 4-stroke engines



678092 17.50



DUAL IGNITION SYSTEM TESTER

- Test the integrity and strength of your ignition system
- Spark plug gap is adjustable from 0mm to 10mm
- The larger the gap our ignition will jump, the stronger your system is
- Will test the ignition on most motorcycles, watercraft, ATVs and snowmobiles



678122 13.99



TUBE STYLE BATTERY TESTER

- Precision calibrated
- Color coded indicator float
- Acid resistant



W1653 5.95



DELUXE 12 VOLT TESTER

- Checks 12 volt accessory circuit
- For autos, trucks, trailers and boats
- Test lead with alligator clip



W2975C 4.95



12 VOLT HEAVY DUTY CIRCUIT TESTER

- Heavy duty test lead with spring clip
- Tests 6, 12 and 24 volt AC and DC circuits
- Reinforcing spring prevents damage to test lead at base of handle



W2981 6.75



HOUR METERS • MINI TACH • STOP WATCH

HOUR METER

- Track service life of your vehicle: oil changes, valve adjustments, spark plugs, etc.
- Easy installation - peel and stick, no wiring necessary, or attach with enclosed hardware, and no battery required, connects to spark plug wire
- Works on any gas engine
- Records and displays to 9,999.9 hours
- Hour glass symbol appears and flashes on/off to indicate counting time
- Automatic roll over
- 100% epoxy encapsulated casing resists water
- One year warranty



HL8063 34.99

RE-SETTABLE HOUR METER DIRT BIKE, ATV & SNOWMOBILES

- Use on any gasoline engine 2/4 stroke
- Flashes "Clean Air Filter" at 5 hours
- Flashes "Change Oil" every 10 hours
- Flashes "Valve Service" every 20 hours
- All services count down the last 10 hours
- Easily reset with a touch of a button
- Timer Mode allows you to record individual sessions
- Total hours accumulated is not resettable



HL8067 39.99

ROBIC STOP WATCH

- Easy to use timer allows you to focus on the event or activity
- Includes Event-Lap/Split Lap Counter
- Ultra precise multi-mode stopwatch with memory recall and lap counter
- Lap, split or event timing
- Five memory recall
- Auto lap counter up to 99
- Auto lap/Split release
- 1st-5th place times
- Water resistant to 30 meters
- Break-Away safety lanyard
- Uses CR-2032 Lithium battery



HL8100 40.95

VIBRATION METER

- Track service life of all non-engine applications - automatic vibration activated recording
- Easy installation - peel and stick, no wiring necessary, or attach with enclosed hardware
- Records and displays to 9,999.9 hours
- Hour glass symbol appears and flashes on/off to indicate counting time
- Automatic roll over / Resolution 0.1 hour
- 100% epoxy encapsulated casing resists water
- No power required - sealed waterproof lifetime battery



HL8065 49.95

HOUR/TACH ADJUSTABLE METER



- Includes log book to track your service and settings
- Adjustable input and re-settable Max RPM
- Works on all gasoline engines
- No battery or ground wire required
- Easy installation
- 100% epoxy encapsulated cases are water resistant
- Record and display in increments of .01 hours up to 9,999.9 hours
- Hourglass symbols appear and flash on/off to indicate counting time
- Automatic roll-over

109000 39.92



HOUR METER



- Includes log book to track your service and settings
- Adjustable input and re-settable Max RPM
- Works on all gasoline engines
- No battery or ground wire required
- Easy installation

109002 39.92



INSTRUMENT STYLE BRACKET

- Fits standard Wiseco hour meter or tachometer



109001 10.75

tires & wheels

axles, hubs & springs

tongue accessories

hitches

electrical

brake parts

trailer hardware

locks & pins

towing & loading

tie downs

tools

chemicals

TRAILER

- tires & wheels
- axles, hubs & springs
- tongue accessories
- hitches
- electrical
- brake parts
- trailer hardware
- locks & pins
- towing & loading
- tie downs
- tools
- chemicals



HOUR AND TACH METERS

PROX HOUR METERS PROGRAM

ProX offers 3 different types of hour meters, with different features and price categories. Motorcycle engines have strict maintenance schedules that must be followed to honor the service life of components and secure reliability of the engine. Knowing what to service and when, is key to a successful preventative maintenance program for your motorcycle, ATV, PWC, boat or snowmobile. All meters are surface mounted meters, which provide what today's Powersports user needs and expect from hour/tach meters. Hour/Tach meters have become the most cost effective method of performing service.

WIRELESS HOUR METER

ProX also offers a state of art Wireless Hour Meter! Unique by eliminating wires the ProX Wireless Hour Meter is a surface mounted vibration activated hour meter, which provides what today's Powersports user needs and expect from hour meters.

Installation is easy without needing to install a wire. Solid state electronics, modern LCD, superb environmental durability and enhanced functionality offer the best of all possibilities without sacrifice to performance, operation or budget.

The wireless hour meter display can be read at all times, with engine off or on. The encapsulate epoxy case is water resistant and shock proof.

With the ProX Wireless Hour Meter you can measure your hours for hours!

ProX Wireless Hour Meter Features:

- Easy installation, no battery and wiring required
- Sensitivity can be set to high or low
- Partial hours can be reset to zero
- Works on all 2/4 stroke gasoline engines
- 100% epoxy encapsulated casing is water resistant and shock-proof
- Automatic roll over
- Records and displays to 99999 hours
- Stand-by time up to over 45.000 hours



	MFG #	PART #	
ProX Wireless Hour Meter	43.HM003	116170	45.80

STANDARD WIRED HOUR METER

Installation is easy with simple patented one wire hook-up. Solid state electronics, modern LCD, superb environmental durability and enhanced functionality offer the best of all possibilities without sacrifice to performance, operation or budget. The hour meter display can be read at all times, with engine off or on. The encapsulated epoxy case is water resistant and shock proof!

ProX Hour Meter Features:

- Works on all 2/4 stroke gasoline engines including newer FI bikes
- Easy installation, no wiring necessary just plug and play
- No power required, includes a 10 year battery sealed inside
- 100% epoxy encapsulated casing is water resistant and shock-proof
- Automatic Roll over
- Resolution 0.1 hour
- Engineered and assembled in the USA
- CE Certified



	MFG #	PART #	
ProX Hour Meter	43.HM001	115930	43.56

WIRED HOUR/TACH METER

Hour/Tach meters have become the most cost effective method of performing service. ProX Racing Parts offer two different meters: The Hour Meter, which shows the hours the engine has ran and the Hour/Tach meter that displays the engine running hours and RPM as well when the engine is running. When the engine is off the meter shows total hours accumulated. Both meters' display can be read at all times, with engine off or on. There is no clicking like mechanical meters. Also the encapsulate epoxy case is water resistant and shock proof.

- Installation is easy with the simple (patented) one wire hook-up
- Solid state electronics, modern LCD, superb environmental durability and enhanced functionality offer the best of all possibilities without sacrifice to performance, operation or budget



	MFG #	PART #	
ProX Hour/Tach Meter	43.HM002	115931	43.56

HOUR METER MOUNT

- Made of aluminium
- Including mounting screws



	MFG #	PART #	
ProX Hour Meter Mount	43.BR001	115929	11.42

TRAILER

12V AUXILIARY POWER SOURCES

The following items provide a dependable source of power for electrical accessories using a standard adapter plug. For spotlights, tire pumps, GPS, cell phones etc. Can be installed on any 12V system such as snowmobiles, ATVs, tractors, boats, vehicles, motor homes etc.

EXTENSION POWER CORD

- With On/Off switch
- Can take up to 12 amp and 150 watts of current



621201 10.95

POWER OUTLET

- 12 Volt power outlet
- Requires 12 volt battery source
- Fits all Ski-Doo models plus many others
- Replaces Ski-Doo #861-5072-00



571085 14.95

9 FOOT POWER OUTLET

- Clips to any 12 volt battery
- Perfect item to plug in spotlights, cell phones, etc. 3 foot cord and 15 amp safety fuse



621203 7.95

DUAL POWER OUTLET

- The perfect solution when you want to plug in several items at one time



621202 10.95

CIGARETTE LIGHTER

- Moisture-resistant lighter designed for all weather use in an open space
- Clamp-on design fits almost anywhere



EM44410 25.95

UNIVERSAL DC CONNECTOR

- Will fit your electric shields, handlebar grip heater, hot socks, phone bags, etc. RCA standard; with dash adapter



621601 6.95

CIGARETTE LIGHTER WITH MAP LIGHT

- 30" extension with combination lighter/map light
- Plugs into lighter socket
- Comes with hang clip



EM44420 23.95

EMERGENCY CELL PHONE CHARGER

- Features 2 bright white LEDs
- Provides limited battery charge for emergency situations
- Charger specifications: Input voltage is 1.2 to 1.5 volts
- Output voltage is 5.7v +/- 5%
- Charging time is 1 to 3 hours (varies by phone, battery levels and capacity)
- Typical efficiency is 88 to 93%
- Includes 7 adaptors for Nokia, Samsung, Sony Ericsson, Apple, Blackberry and Motorola brand cell phones



260077 10.60

RCA JACK DUAL SPLITTER

- Converts any single-output RCA power source into two power ports
- Works great when you need to operate communication systems, heated helmet shields and other electrical accessories



120142 4.95

CIGARETTE LIGHTER POWER PORT

Equipped with an LED power-alert, RCA output jack



Replaceable 10 Amp Fuse **120120 9.95**
Non-replaceable Fuse **621200 6.95**

CIGARETTE LIGHTER POWER PORT

- Equipped with an LED power-alert & USB output jack



120141 10.50

FAST SAME DAY SHIPPING

tires & wheels
axles, hubs & springs
tongue accessories
hitches
electrical
brake parts
trailer hardware
locks & pins
towing & loading
tie downs
tools
chemicals

TRAILER

TOOLS

tires & wheels
 axles, hubs & springs
 tongue accessories
 hitches
 electrical
 brake parts
 trailer hardware
 locks & pins
 towing & loading
 tie downs
 tools
 chemicals

TRAILER

CABLE LUBER V3

- Original Motion Pro design seals completely around cable housing
- Makes it easy to clean and lubricate control cables
- Less mess and less wasted lubricant
- Unique design makes it the best sealing cable luber on the market
- Works on most control cables with 4 mm to 8 mm OD housing
- Seals over free spinning end fittings
- Adjustable plunger insures efficient use of cable lube
- Easy to use and clean
- Best if used with Motion Pro Cable Lube (15-0002), not included
- Patent pending



144378 24.99

7PC CORDLESS GREASE GUN ACCESSORIES

- For all types of grease lubrication applications
- 1 press on 90 degree angle tip
- One straight extension tip
- One 12" hose extension
- One slide on 90 degree coupler
- One rubber tipped nozzle
- One needle nozzle
- One 360 degree coupler



260099 60.95

12" GREASE GUN FLEX HOSE

- 12" hose for hard to reach areas
- For use with hand and air powered grease guns
- Size: 12"
- Working Pressure (PSI): 4,500
- Burst Pressure (PSI): 12,000
- NPT (IN): 1/8"



260102 6.95

NEEDLE NOSE ADAPTER

- Dispenses a fine line of grease to confined areas
- Includes large and small sleeve to fit standard couplers
- Great for 4WD (CV) universal joints
- WARNING: Maximum working pressure - 3,000 PSI
- For use with hand grease guns only



260107 5.95

GREASE GUN COUPLER

- Fits most hand operated grease guns.
- Maximum Working Pressure (PSI): 3,000
- Burst Pressure (PSI): 6,000
- NPT (IN): 1/8"



260104 4.95

GREASE INJECTOR NEEDLE

- 18 ga. Tempered stainless steel
- Can be easily inserted under or through bearing seals
- Includes protective cover
- WARNING: Maximum working pressure - 3,000 PSI.
- For use with with hand grease guns only



260105 4.95

4" GREASE GUN NEEDLE NOSE ADAPTER

- Dispenses a fine line of grease to confined areas
- Includes large and small sleeve to fit standard couplers
- Great for 4WD (CV) universal joints
- WARNING: Maximum working pressure - 3,000 PSI
- For use with hand grease guns only



260106 10.95

18" GREASE GUN FLEX HOSE

- 18" hose for hard to reach areas
- For use with hand and air powered grease guns
- Size: 18"
- Working Pressure (PSI): 4,500
- Burst Pressure (PSI): 10,000
- NPT (IN): 1/8"



260103 7.95

WALL MOUNTED GREASE GUN HOLDER

- Wall mount design
- Center latch locks
- Corrosion resistant finish



260108 8.95

MINI GREASE GUN W/GREASE

- Heavy duty construction
- "Pistol Grip" action for easy use in tight spaces
- Vented zinc die cast head cap
- Positive lock for easy filling
- Air bleeder valve eliminates air lock
- Uses 3 oz. grease cartridge (included)



260067 19.95

PRO PISTOL GRIP GREASE GUN

- Professional quality heavy duty construction and chrome plated finish for long service life
- Pistol grip action for easy use
- Vented zinc die cast head cap
- Positive lock for easy filling
- Air bleeder valve eliminates air lock
- 2 way filling: standard 14 oz. grease cartridge or bulk
- Comfort grip lever handle



260066 24.95



WHITE LITHIUM GREASE

- Includes zinc additives for a clean, white color
- Ideal for general home, shop, agricultural and industrial applications
- Contains no silicons and can be used on plastic components



DESCRIPTION	QTY/CS	MFG #	PART #	
14 oz. Cartridge	10	11354	LB11354	11.95



DESCRIPTION	QTY/CS	MFG #	PART #	
1 lb. Resealable Tub	12	11350	LB11350	10.95

2-PACK 3 OZ MULTI PURPOSE

- Multi purpose lithium based grease is designed for light duty applications which require extended lubrication
- For light duty automotive, industrial, agricultural or commercial equipment
- Smooth consistency, water resistant and extremely stable
- Use on springs, water pumps, bearings, chassis fittings and any general lubrication projects



260068 7.95

LEVER ACTION GREASE GUN

- Uses 14 oz. cartridge
- Made for the punishing day-in and day-out service required by industrial customers



LB11155 40.95

PRO GREASE GUN

- Professional quality heavy duty construction and chrome plated finish for long service life
- Short stroke "lever action" for easy use in tight spaces
- Vented zinc die cast head cap
- Positive lock for easy filling
- Air bleeder valve eliminates air lock
- Knurled thick wall barrel for secure grip
- Comfort grip lever handle
- Uses standard 14 oz. grease cartridge



W54202 25.95

BEARING PACKER

- Quickly and thoroughly packs bearings with new grease while forcing out old grease all in one easy operation
- Accommodates most roller and ball bearings



260101 8.95

SUCTION GUN

- Professional quality heavy duty construction and chrome plated finish for long service life
- Perfect for transmissions, differentials, gear cases, lower units, crankcases, etc.
- Zinc die cast head cap
- No priming necessary
- 12" flexible hose
- Knurled thick wall barrel for secure grip
- 1 pint capacity



260100 13.95

- tires & wheels
- axles, hubs & springs
- tongue accessories
- hitches
- electrical
- brake parts
- trailer hardware
- locks & pins
- towing & loading
- tie downs
- tools
- chemicals

TRAILER

TOOLS

- tires & wheels
- axles, hubs & springs
- tongue accessories
- hitches
- electrical
- brake parts
- trailer hardware
- locks & pins
- towing & loading
- tie downs
- tools
- chemicals

TRAILER

SMALL OIL FILTER PLIERS

- Comfort grip handles
- Safety button locks in place
- Three different positions
- Fits sizes 2-1/4" to 3-1/2" diameter



260109 11.95

LARGE OIL FILTER PLIERS

- Comfort grip handles
- Safety button locks in place
- Three different positions
- Fits sizes 1-7/8" to 4" diameter



260110 12.95

SWIVEL OIL FILTER WRENCH

- 2-15/16" to 3-3/4"
- Swivel handle design provides access in confined areas
- Vinyl grip handle
- Studded band for better grip
- Removes most spin on type filters



260111 7.95

CUP TYPE OIL FILTER WRENCH

- Works with 3/8" drive wrenches



SIZE	PART #	
64.7 mm	EM04181	7.95
67 mm	EM04182	7.95

7 QUART DRAIN PAN

- Molded handles and pour spout
- Easy to use
- Chemical and solvent resistant, won't rust or corrode
- 13-1/2" x 11" x 4"



260065 4.95



DELUXE AUXILIARY TANK FOR FUEL-INJECTED SYSTEMS

- For use with new fuel-injected models with external fuel pumps as well as standard carburetor type motorcycles
- Upgraded petcock for easier opening and closing
- Built-in fuel return (for fuel-injected models) and breather on cap
- Not designed for fuel storage
- Graduated scale located on the side of bottle
- Includes 4 ft. of 1/4 inch fuel line
- Holds up to 2000cc or 1/2 gallon of fluid
- Tank can also be used for refilling transmission oil on some late model MX bikes



142150 104.99

5 GALLON PAIL PUMP

- The economical plastic pump fits on all Maxima 5-gallon pails and 55-gallon drums



930069 37.95

QUART/GALLON FLUID PUMP

- Unique double threaded cap fits both quart and gallon size containers
- Convenient and versatile for hard to reach places
- Eliminates mess and waste



260116 9.95



SUPER SIPHON™

- Clear tube to view liquid flow
- Safe and easy to use
- Perfect for transferring all types of liquids



FLO TOOL

232022 6.69

DELUXE RUBBER SIPHON HOSE

- All purpose
- Oil and gas resistant
- Deluxe model



PT
Performance Tool

260117 6.95

SHAKER SIPHON HOSES

- Shaker Siphon helps you transfer fluids with ease
- Moves up to 3.5 gallons a minute, through a 6-foot anti-static tube
- Safely transfer fuels, gasoline, diesel, water and many other liquids
- Simply shake the hose up and down to start the transfer



PT
Performance Tool

260157 17.95

LIQUID TRANSFER SHAKER SIPHON

- Quickly transfer up to 7 gallons per minute
- Long flexible anti-static food grade tubing
- Anti-static provides safe transfer of fuels such as gasoline and diesel
- Food grade allows transfer of water, beer, wine and other consumable liquids
- Simple, safe and easy to use



PT
Performance Tool

260158 19.95

SHAKER SIPHON™

- Moves up to 3.5 gallons/minute
- 6 foot anti-static tube
- Perfect for home, auto, ranch, marine or farm



FLO TOOL

232021 14.95



SYTHON HOSE

- Siphon liquids fast with the Sython Hose!
- Just shake to start the transfer
- 6 ft. hose
- Display packaged

62-07030 14.95

BATTERY OPERATED TRANSFER PUMP



PT
Performance Tool

260160 16.95

- Easier and more convenient than your standard siphon pump
- This highly versatile battery operated pump is capable of 2.6 gallons per minute
- Pump fuel from your safety can to a generator, car, motorcycle, lawn equipment or any other fuel driven item
- Works well with kerosene for heaters or stoves also
- Chemical fluids, cleaners, water (not for use with drinking water), light oil, etc

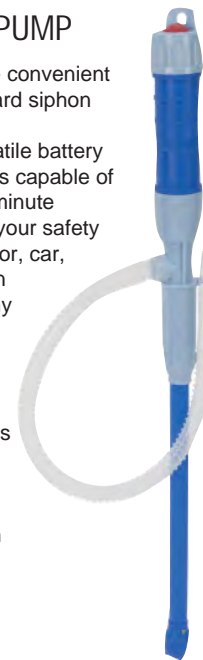

TRANSMISSION FLUID/GEAR OIL SPOUT

- On/off adjustable flow spout
- Reduced tip for transmission filler tubes
- Fits quart or gallon containers

FLO TOOL

232019 5.19



tires & wheels

axles, hubs & springs

tongue accessories

hitches

electrical

brake parts

trailer hardware

locks & pins

towing & loading

tie downs

tools

chemicals

TRAILER

- tires & wheels
- axles, hubs & springs
- tongue accessories
- hitches
- electrical
- brake parts
- trailer hardware
- locks & pins
- towing & loading
- tie downs
- tools
- chemicals



REMOVES WATER FROM FUEL

The Fuel Filter Funnel by Mr. Funnel is a heavy-duty, anti-static, and fast flow funnel with built-in filter technology. When fuel is poured through the Fuel Filter Funnel, water and debris will not pass through the filter's fluoropolymer-coated stainless steel filter. Only filtered fuel flows through to your engine, improving its efficiency, durability, and proper operation. The sump area collects the deflected water and debris for proper disposal. The Fuel Filter Funnel by Mr. Funnel will filter gasoline, diesel, heating oil, kerosene and 2-cycle mixed gas.



Flexible Spout Extension
for use with 232001 funnel only



232004 6.99



Our fastest flow model, this model can also be used at a fuel pump.

MODEL: F15
for transferring more than five gallons of fuel
Height: 10"
Diameter: 8.5"
Flow Rate: 12 gpm

232003 67.49



MODEL: F1NC
medium non-conductive portable fuel filter
Height: 9"
Diameter: 5.5"
Flow Rate: 3.5 gpm

232023 13.59



MODEL: F3NC
small non-conductive portable fuel filter
Height: 6"
Diameter: 3.5"
Flow Rate: 2.5 gpm

232024 20.29

RATIO-RITE

PERFECT GAS/OIL MIXTURE MEASURING CUP

- Get a perfect mix every time
- Fill your polypropylene Ratio-Rite to the pre-calibrated ratio mark and pour into gas
- Ratios are from 16:1 to 44:1 for 1, 1-1/2, 2, 2-1/2 gal.
- Calibrations also include oz., cc's, and pints on the opposite side for transmission oil, for oil, etc.
- Total capacity is 24 oz.



RR100 6.50

REPLACEMENT LID FOR RR100

- Sold separately
- Seals the cup from dirt and spillage
- Lid can be attached to cup handle to keep from being misplaced



RR105 2.95

TRAILER

NO SPILL OIL SPOUT™

- Twist on, twist off
- No Spills, No Mess!™
- Adjustable built-in valve



232020 3.29

PLASTIC MEASURING CONTAINER

- Perfect for mixing and measuring gas and oil
- 2 sizes available
- 500 ml, 17 oz



62-12061 7.95

3 PIECE SET
GENERAL PURPOSE FUNNELS

- Includes small, medium & large funnels



232018 4.59

2 QUART FUNNEL
WITH SCREEN

- 2 quart capacity for large volume
- Filter screen included to clean fluids
- Built-in hang tag



232010 4.29

1 PINT FUNNEL
WITH SCREEN

- 1 pint capacity, great for smaller engines
- Filter screen included to clean fluids
- Built-in hang tag



232011 2.79

- tires & wheels
- axles, hubs & springs
- tongue accessories
- hitches
- electrical
- brake parts
- trailer hardware
- locks & pins
- towing & loading
- tie downs
- tools
- chemicals

2 QUART PLASTIC FUNNEL

- Rugged, corrosion resistant all purpose funnel
- Complete with fine mesh straining screen and handy hanging tab
- Capacity indicates what the funnel will hold when the outlet is blocked



W54276 5.95

2 PIECE FLEX FUNNEL
W/HANDLE

- Removable spout for multiple applications
- Easy hold handle



260113 3.95



ALL PURPOSE FUNNELS



1/2 PINT

W4007 2.95

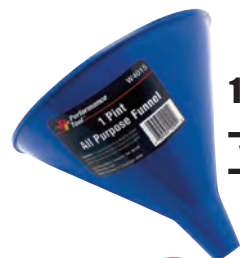

1 PINT

W4015 2.95



1 QUART

W4064 3.95

PLASTIC FUNNEL W/18" SPOUT



- 6" diameter funnel
- 18" flexible spout

260112 2.95

EXTRA LARGE FUNNEL

- All purpose 18" funnel
- Great for hard to reach applications
- Tapered spout easily fits small reservoir openings



W40340 4.95

TRAILER

- tires & wheels
- axles, hubs & springs
- tongue accessories
- hitches
- electrical
- brake parts
- trailer hardware
- locks & pins
- towing & loading
- tie downs
- tools
- chemicals

GAS GAUGE FUNNEL™

- Floating indicator signals when gas tank is full, helps prevent spills and overfills
- Great for lawn mowers and more
- No-mess splash guard



232008 5.49

LOCKING OIL FUNNEL™

- Lock-in oil filler hole
- Funnel holds bottle while pouring
- No waste and no-mess quick pouring



232012 3.29

TIGHT SPOT FUNNEL

- Fits Where Other Funnels Don't™
- Ideal for tight engine compartments
- Molded hand-holds for a better grip



232009 4.29

FLEX FUNNEL™

- Ideal for hard to reach applications
- Distinct hand holds for a better grip
- Detachable flexible spout



232016 5.89

SUPER MULTI-PURPOSE FUNNEL™

- Large size (18") for multiple applications
- Perfect for transmissions and other engine fluids



232015 5.59

QUICKFILL® FUNNEL

- Speed channels maximize flow rate
- Distinct hand hold for a better grip
- No-mess splash guard



232007 4.29

TRANSMISSION FUNNEL

- 18" funnel made from durable high quality copolymer plastic
- Designed for hard to reach applications
- Perfect for transmission fluid



232013 2.39

MULTI-TASK 5-IN-1 FUNNEL™

- Holds one quart oil bottle
- Three interchangeable spouts, including the Flexi-Spout
- Nestable



232014 6.99

TRAILER



MOTORSPORTS CONTAINERS

SQUARE CONTAINERS



5-GALLON CONTAINERS

VP Sportsman's Containers are made with only the highest quality virgin high-density polyethylene, including 30% more material than standard containers to withstand the roughest treatment. The containers are subjected to a 15-point quality test and carry a 3-year limited warranty. They feature an ergonomically contoured handle, bottom grip for easy pouring and a non-breakable multipurpose cap with rubber gaskets.

EXCELLENT FOR STORAGE & TRANSPORT OF:

- Water
- Automotive & industrial fluid
- Deer corn, milo & oats
- Feed pellets, bird seed
- Rock salt
- Oil & liquid absorbents

GREAT FOR MIXING/ DISPENSING:

- Animal attractants & feed
- Herbicides, insecticides



PINK

ORANGE

BLACK

CAMO

BLACK/ORANGE

CALIFORNIA COMPLIANCE

Due to restrictions on the sale of containers in California, Automatic Distributors has updated part numbers for VP Racing containers. The products will remain the same, apart from different verbiage on the bottom of the cans. There is no change for the caps, vents or hoses. These new Cali part numbers can be sold everywhere and are no-longer considered restricted in the state of California. The chart below indicates the old part numbers on the left, and the new numbers to the right which are under the CALI column.

VP BREAST CANCER AWARENESS

* For each pink container sold, a percentage of the proceeds will be donated by VP Racing Fuels to support the cancer prevention research, education and community outreach programs of the Prevent Cancer Foundation. The VP Breast Cancer Awareness Motorsport Containers carry a 3-year limited warranty against cracks, leaks or splitting. Hoses not included.

NOTE: The VP Breast Cancer Awareness Motorsport Container is intended only for use as a rapid refueling device for racing vehicles used in professional off road and closed course competition racing events. It is NOT a portable fuel container as described by ASTM, EPA, ARB or other state or federal agencies. Intended for racing fuel only; not to be used for street legal fuels.

LIMITED EDITION



PATRIOTIC

COLOR	NON- CALI PART #	CALI PART #	
RED	650637	650819	39.95
WHITE	650636	650821	39.95
BLUE	650638	650822	39.95
YELLOW	650661	650823	39.95
GREEN	650662	650824	39.95
ORANGE	650663	650825	39.95
CAMO	650659	650828	39.95
BLACK/ ORANGE	650692	650829	39.95
BLACK	650693	650826	39.95
PINK	650646*	650827*	39.95
PATRIOTIC	650685	650820	39.95

HOSE SOLD SEPARATELY

- tires & wheels
- axles, hubs & springs
- tongue accessories
- hitches
- electrical
- brake parts
- trailer hardware
- locks & pins
- towing & loading
- tie downs
- tools
- chemicals

TRAILER

FAST SAME DAY SHIPPING

- tires & wheels
- axles, hubs & springs
- tongue accessories
- hitches
- electrical
- brake parts
- trailer hardware
- locks & pins
- towing & loading
- tie downs
- tools
- chemicals

TRAILER



MOTORSPORTS CONTAINERS

ROUND CONTAINERS



5-GALLON CONTAINERS

- Ergonomically contoured handle and bottom grip for easy pouring
- Extra large cap with rubber o-ring gasket
- Made from virgin density polyethylene
- Adjustable screw on air vent
- Containers have accurate graduated marks indicating gallons and liters
- 5 gallon capacity
- Hose sold separately (Part #650643 & 650684)
- Three year warranty



WHITE



BLUE



RED

COLOR	PART #	
WHITE	650642	34.95
BLUE	650647	34.95
RED	650648	34.95

HOSE SOLD SEPARATELY



MOTORSPORTS CONTAINERS

3-GALLON CONTAINERS



- Ergonomically contoured handle and bottom grip for easy pouring
- Extra large cap with rubber o-ring gasket
- Made from virgin density polyethylene
- Adjustable screw on air vent
- Containers have accurate graduated marks indicating gallons and liters
- 3 gallon capacity
- Hose sold separately (Part #650643 & 650684)
- Three year warranty



COLOR	PART #	CALI PART #	
BLUE	650764	650833	28.95

COLOR	PART #	CALI PART #	
WHITE	650765	650832	28.95

HOSE SOLD SEPARATELY

REPLACEMENT PARTS

STANDARD 3/4" HOSE



650684 10.95

3/4" HOSE ASSEMBLY WITH CAP



650643 11.95



CAP

650644 10.45



VENT CAP

650645 2.95



TRIGGER

FLUID CONTROL SYSTEM DELIVER POWER TO YOUR MACHINE

- tires & wheels
- axles, hubs & springs
- tongue accessories
- hitches
- electrical
- brake parts
- trailer hardware
- locks & pins
- towing & loading
- tie downs
- tools
- chemicals



- Ergo push button operation
- No-spill design
- Variable fluid flow rate control
- Self venting
- Over 3 gallons per minute flow rate
- High quality materials
- Manufactured and assembled in the USA

HIGH VOLUME FLUID DISPENSING WITH COMPLETE CONTROL

The Trigger is designed to allow variable fluid delivery over 3 gallons per minutes. Once the Trigger is installed on your utility jug the days of spilling on your expensive graphics or machine will be over. Because the Trigger is self-venting, you will no longer need to open a separate vent on your utility jug to increase your fluid flow. Leave your vent closed. Simply press the Trigger button and fluid flow. Your desired rate of flow will be determined by how far you press the button. Once you have reached your desired fill level, release the button and fluid flow will stop. The result is a clean, completely controlled delivery of fluid.

VP RACING TRIGGER

700001 28.95



PRODUCT SPECIFICATIONS

Part #	7600001
UPC #	86895000102
Length	16 inches
Height	4 inches
Weight	.57 LBS
Country of Origin	USA

Insert Ventilation Tube. Push FIRMLY and twist until you feel the tube fully seat.

Correctly assembled Trigger.

Apply downward pressure when hand tightening. Ensure correct thread alignment to avoid cross-threading. Do not over tighten.

Tilt container. Press trigger for flow. Release trigger to stop flow. Keep button upright while pouring.

Trigger is self-venting. Ensure all vents on container are closed.

FUNCTIONAL with the FOLLOWING UTILITY JUGS

- VP Racing Motorsport Jug
- VP Racing Round Motorsport Jug
- LC 5 Gallon Jug
- LC2 5 Gallon Jug
- Scribner 5 Gallon Jug
- JEGS Square 5 Gallon Jug
- Sunco Race Fuel 5 Gallon Multi Fuel Jug
- Pit Posse 5 Gallon Utility Jug
- Pit Posse 5 Gallon VP Type 5 Gallon Jug



BRONCO HOSE BENDER

Fits hoses up to 1" o.d.

UNIT	PART #	
Each	128181	4.95
16 pack	128662	69.95



TRAILER



FUEL TRANSFER SOLUTIONS

Terapumps product line eliminates the lifting of large, heavy, gas cans and spilling wasted fuel. Their exclusive design makes transferring fuel to cars, trucks, off road vehicles, boats, mowers and more, painless and hassle free. We are excited that Terapump is now part of the amazing group of brands brought to you by Automatic Distributors.

- tires & wheels
- axles, hubs & springs
- tongue accessories
- hitches
- electrical
- brake parts
- trailer hardware
- locks & pins
- towing & loading
- tie downs
- tools
- chemicals



FUEL TRANSFER PUMP

TREP01-T FUEL TRANSFER PUMP



FEATURES

- Applicable Liquids: Any non-corrosive liquids such as gas, diesel, and water (DO NOT use for drinking water)
- Delivery Volume: 9 Liters per Minute (2.5 Gallons per Minute)
- Built in Flow Control Handle for easy refueling
- Works great with Kerosene heaters
- Flow Control: Allows for quick starting and stopping
- Makes refueling generators, lawn equipment, farm equipment simple, lifting heavy gas can's to refuel your equipment will be a thing of the past
- Backed by a 1-Year Manufacturer's Warranty

DESCRIPTION	PART #
TREP01-T BATTERY POWERED PORTABLE PUMP	877008 49.99



COMPATIBLE LIQUIDS

- Gasoline
- Diesel
- Kerosene
- DEF
- Antifreeze
- AG Chemicals
- Washer Fluid

SPECIFICATIONS

POWER SOURCE	2 D BATTERIES
INTAKE HOSE	17.6 INCHES
DISCHARGE HOSE	39.4 INCHES
FLOW RATE	2.5 GALLONS/MINUTE



FUEL TRANSFER PUMP XL

TRFA01-XL BATTERY POWERED TRANSFER PUMP XL



FEATURES

- Flow Rate of up to 2.4 Gallons per Minute
- Works with Any non-corrosive liquids such as gas, non-potable water, kerosene, diesel or light oils
- Water-Resistant Battery Cover for accidental fuel spills
- Auto-Stop System to prevent fuel loss or accidental spills
- Refuel boats, ATVs, motorcycles, cars, generators, lawn mowers and more!
- Backed by a 1-Year Manufacturer's Warranty

DESCRIPTION	PART #
TRFA01-XL-FUEL TRANSFER PUMP W/EXTENDED HOSES AND 4TH ADAPTER	877002 85.99

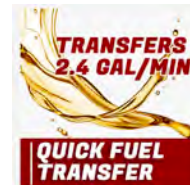

COMPATIBLE LIQUIDS

- Gasoline
- Diesel
- Kerosene

SPECIFICATIONS

POWER SOURCE	4 AA BATTERIES
INTAKE HOSE	23.8 INCHES
DISCHARGE HOSE	51 INCHES
FLOW RATE	2.4 GALLONS/MINUTE

*Can not included

TRAILER



CHEMICAL RESISTANT TRANSFER PUMP

TRFA01-XL-CH CHEMICAL RESISTANT TRANSFER PUMP



FEATURES

- Flow Rate of up to 2.3 Gallons per Minute
- Works with Methanol, ethanol, DEF(AdBlue), liquid soda, window washer fluids (Especially made of Ethanol), brake cleaner & non-potable water
- Water-Resistant Battery Cover for accidental fuel spills
- Auto-Stop System to prevent fuel loss or accidental spills
- Refuel boats, ATVs, motorcycles, cars, generators, lawn mowers and more!
- Backed by a 1-Year Manufacturer's Warranty

DESCRIPTION	PART #
TRFA01- XL-CH ETHANOL/ METHANOL FUEL TRANSFER PUMP	877003 85.99

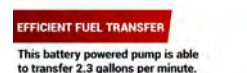
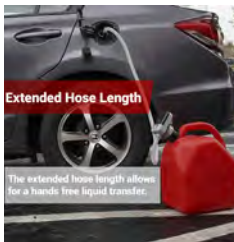

COMPATIBLE LIQUIDS

- Ethanol
- Methanol
- DEF
- Non-Chlorinated Brake Cleaner

SPECIFICATIONS

POWER SOURCE	4 AA BATTERIES
INTAKE HOSE	23.6 INCHES
DISCHARGE HOSE	51 INCHES
FLOW RATE	2.4 GALLONS/MINUTE

*Can not included

FUEL TRANSFER SOLUTIONS **TIER A PUMP**

- tires & wheels
- axles, hubs & springs
- tongue accessories
- hitches
- electrical
- brake parts
- trailer hardware
- locks & pins
- towing & loading
- tie downs
- tools
- chemicals



METERED ELECTRIC PUMP

NEW

TREDRUM-T METERED ELECTRIC DRUM PUMP

- FEATURES**
- Drum Barrel Fit: Applicable on 55 gallon drums & IBC Totes
 - Suction Tube: length is adjustable by 0.6" according to height of the drum
 - Adapters: Includes a 2" NPT to 2" Buttress adapters
 - End Cap Filter: Filter-equipped intake end protects the motor from damage due to alien matters
 - Caution: Not use with Drinking Water, Flammable liquids or Concentrated Acids
 - 35L: Electric Fuel Meter for precise flow rates
 - Backed by a 1-Year Manufacturers Warranty

COMPATIBLE LIQUIDS

- Diesel
- DEF (AdBlue)
- Non-Potable water
- Kerosene
- Antifreeze
- Windshield
- Washer Fluid
- Mild Detergents
- Agricultural Chemicals & Light Oils

DESCRIPTION	PART #
TREDRUM-T METERED ELECTRIC DRUM PUMP TELESCOPIC	877005 534.99

FLOW METER

35L DIGITAL METER
Measures flow rate of liquid running through pump.



FLOW CONTROL

DISCHARGE HOSE

This 6.6 ft discharge hose allows for a 7.1 GPM transfer rate.

OPTIONAL DC CABLE



TELESCOPIC ELECTRIC PUMP

NEW

TREDRUM-T TELESCOPIC ELECTRIC DRUM PUMP

- FEATURES**
- Drum Barrel Fit: Applicable on 55 gallon drums & up to 275 Gallon IBC Totes
 - Suction Tube: length is adjustable by 0.6" according to height of the drum
 - Adapters: Includes a 2" NPT to 2" Buttress adapters
 - End Cap Filter: Filter-equipped intake end protects the motor from damage due to alien matters
 - Caution: Do Not use with Drinking Water, Flammable liquids or Concentrated Acids
 - Backed by a 1-Year Manufacturer's Warranty



DESCRIPTION	PART #
TREDRUM-T TELESCOPIC ELECTRIC DRUM PUMP	877006 349.99

FITS VARIOUS DRUMS



DRUM BUNG ADAPTER

CONVERTS DRUM BUNG FROM 2" NPT TO 2" BUTTRESS



COMPATIBLE LIQUIDS

- Engine Oil
- Diesel
- Kerosene
- DEF
- Hydraulic Fluid
- Agricultural Chemicals
- Washer Fluid
- Antifreeze

SPECIFICATIONS

POWER SOURCE	110V AC PLUG-IN
INTAKE HOSE	33.5 INCHES
DISCHARGE HOSE	78.7 INCHES
FLOW RATE	7.1 GPM (OIL) 4.3 GPM



LEVER ACTION DRUM PUMP

NEW

TRD490N LEVER ACTION MANUAL DRUM PUMP

- FEATURES**
- Fits: 50 to 205L Drums (15-55 Gallons)
 - Telescopic Intake: Adjustable to fit various Drum Barrel sizes
 - No Electricity Required: Utilizes siphon action to transfer liquids by a simple grip and pump
 - Fits Various Drum Barrels: Built-in 2 inch drum bung adapter fits various drum barrels for vacuum
 - Applicable: Diesel, Kerosene, Lubricating oils up to SAE 90, Works with most Petroleum Based Media
 - Works great with farm equipment, Industrial Vehicles and in Automotive Shops
 - Backed by a 1-Year Manufacturer's Warranty

COMPATIBLE LIQUIDS

- Oil based fluids
- Heating Oils
- Motor Oils
- Heavy & Light Oils
- Diesel & Kerosene



DESCRIPTION

Suction type: Manual operated lever action oil pump with curved metal spout and telescopic plastic suction tube

Power: Manual

Applicable liquids: oil based fluids, Heating oils, Motor oils, Heavy & Light oils, Diesel & Kerosene

Delivery volume: 10 ounces per stroke (300 ml)

Total pump length: 35.5 to 50.5 inches (902 to 1283 mm)

Intake diameter: 0.75 inches (19 mm)



- tires & wheels
- axles, hubs & springs
- tongue accessories
- hitches
- electrical
- brake parts
- trailer hardware
- locks & pins
- towing & loading
- tie downs
- tools
- chemicals

TRAILER

COMBO Y-DRIVE WRENCH

- Innovative dual-use design combines 6 tools into one
- 8mm, 10mm and 12mm hex socket
- 4mm, 5mm and 8mm hex drive
- Padded Y-shape for excellent grip and leverage
- Compact design is ideal for trail tool packs
- Chrome-vanadium tool steel
- Limited lifetime warranty



144164 16.99

SPINNER T-HANDLE, BIT DRIVER

- Bearing mounted spinner provides faster and easier removal and installation of bolts and nuts
- 1/4" hex drive head accepts most common driver bits
- Magnet inside drive head holds drive bits firmly in place
- Narrow drive head profile fits into tight spaces
- Padded grip handle
- Chrome vanadium handle and shaft
- Durable chrome finish on shaft and handle
- Blue anodized spinner with laser engraved Motion Pro logo
- Shaft is 8" long
- Bits not included
- Limited lifetime warranty



144171 36.99

T-HANDLE BIT DRIVER WITH NO. 1,2,3 METRIC PHILLIPS BITS

- High quality Motion Pro standard bit driver T-handle
- Features three 1/4" drive heads, one at end of shaft and two at each end of handle with magnets to hold drivers firmly in place
- Includes high grade S2 tool steel JIS cross-head bits no. 1, no. 2, and no. 3, but also accepts all common driver bits
- The included JIS cross-head bits are a must have for most Japanese made bikes and work equally well on traditional Phillips head screws (Use of traditional Phillips driver on JIS cross head screws will damage screw head)
- Narrow drive head profile fits into tight spaces
- Chrome vanadium handle and shaft
- Durable chrome finish on shaft and handle
- Shaft is 8.5" long
- Limited lifetime warranty



144172 32.99

1/4 INCH TRI-DRIVE MINI T-HANDLE KIT

- Use T-Handle drive to tighten/loosen fasteners and shaft drive for quick installation/removal of fasteners
- 1/4" drive has a compact 6" drive shaft length
- Compact size for use in tight spaces and is easy to carry
- Includes 8mm, 10mm, 12mm and 13mm sockets
- Use with 1/4" drive sockets, hex drives, crow's foot, etc.
- Chrome-vanadium tool steel shaft and T-Handle
- Durable nickel pewter finish
- Limited lifetime warranty



142305 19.99

T-HANDLE SOCKETS

- Metric T-Handles feature a durable nickel pewter finish
- Deep 6-point sockets
- Limited lifetime warranty

SIZE	PART #	
8mm	678093	6.99
10mm	678094	7.99
12mm	678095	8.50
13mm	678096	8.99
14mm	678097	8.99
17mm	678098	13.50
19mm	678099	13.50



T-HANDLE DRIVES

- Use any 1/4" or 3/8" drive attachments such as sockets hex drives crows foot or swivels
- Chrome vanadium tool steel shafts
- Durable nickel pewter finish

SIZE	PART #	
1/4" Drive / 8-1/2" Long	678158	8.99
3/8" Drive / 10-1/2" Long	678159	12.99



T-HANDLE RACK

- Chrome finish
- 11 slots
- Hooks on your tool box



680144 19.99

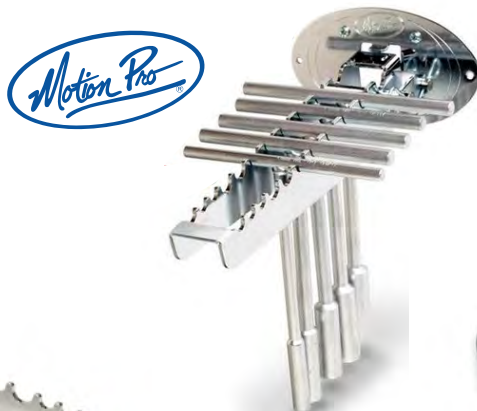

WALL BRACKET FOR T-HANDLE RACK

- Wall bracket for T-handle rack above to mount on a wall, post, or any flat surface
- Features a quick release pin
- Heavy duty 12 gauge zinc plated steel
- Includes built in bottle opener



680435 22.99

TMV T-WRENCH SET

- T-handle set includes:
- 8mm
 - 10mm
 - 12mm
 - 14mm
 - 17mm



631535 32.95



- tires & wheels
- axles, hubs & springs
- tongue accessories
- hitches
- electrical
- brake parts
- trailer hardware
- locks & pins
- towing & loading
- tie downs
- tools
- chemicals

36 PC 1/4" DR MECHANIC'S SET

- Socket openings are designed to reduce fastener rounding
- Chrome vanadium alloy steel construction for strength and durability
- Polished nickel chrome plated finish resists corrosion
- Features high torque quick release ratchet
- 72 gear teeth for 5° sweep
- Smaller head for tight areas
- 1pc each spinner handle, universal joint and 3" extension bar
- 10pc standard SAE socket sizes: 5/32", 3/16", 7/32", 1/4", 9/32", 5/16", 11/32", 3/8", 7/16" and 1/2"
- 6pc Deep SAE socket sizes: 7/32", 1/4", 5/16", 3/8", 7/16" and 1/2"
- 10pc standard mm socket sizes: 4mm, 5mm, 6mm, 7mm, 8mm, 9mm, 10mm, 11mm, 12mm and 13mm
- 6pc Deep mm socket sizes: 4mm, 6mm, 7mm, 8mm, 10mm and 12mm



PT
Performance Tool

260040 59.95

51 PC 3/8" DR MECHANIC'S SET

- Features high torque quick release ratchet
- 72 gear teeth for 5° sweep and smaller head for tight areas
- 12pt SAE and Metric standard and deep wall sockets
- Chrome vanadium alloy steel for strength and durability
- Set contents: 1pc. 3/8" dr. quick release ratchet, 1pc. universal joint, 2pcs. 3 and 6" extensions, 2pcs spark plug sockets, 25pcs. SAE and metric std. sockets and 20pcs. SAE and metric deep sockets
- SAE std. Sizes: 1/4", 5/16", 3/8", 7/16", 1/2", 9/16", 5/8", 11/16", 3/4", 13/16", 7/8" and 15/16"
- SAE Deep Sizes: 5/16", 3/8", 7/16", 1/2", 9/16", 5/8", 3/4", 13/16", 7/8" and 15/16"
- SAE Spark Plug Sizes: 5/8" and 13/16"
- Metric std. Sizes: 7mm, 8mm, 9mm, 10mm, 11mm, 12mm, 13mm, 14mm, 15mm, 16mm, 17mm, 18mm and 19mm
- Metric Deep Sizes: 8mm, 10mm, 12mm, 13mm, 14mm, 15mm, 16mm, 17mm, 18 and 19mm
- Durable storage case also included



PT
Performance Tool

260057 116.95

19 PC 3/8" DR BLACK SOCKET SET

- 18 double plated black sockets feature both SAE and Metric sockets in popular sizes
- Easy to read laser etching
- Ratchet features indestructible protective coating, chrome vanadium steel core with precision 72 gear teeth
- 6pt SAE Sizes: 5/16, 3/8, 7/16, 1/2, 9/16, 5/8, 11/16, 3/4 and 13/16"
- 6pt mm sizes: 9, 10, 11, 12, 13, 14, 15, 17 and 19mm



PT
Performance Tool

260054 35.95

1/4" DR SOCKET RAIL

- 18" overall length
- Holds 14 sockets



260032 6.95

PT
Performance Tool

3/8" DR SOCKET RAIL

- 18" overall length
- Holds 14 sockets



260042 7.95

PT
Performance Tool

1/4" DR UNIVERSAL JOINT

- Chrome vanadium alloy steel construction for strength and durability
- Polished nickel chrome plated finish resists corrosion



260035 5.95

1/4" FX 3/8" M ADAPTER

- Chrome vanadium alloy steel construction for strength and durability
- Polished nickel chrome plated finish resists corrosion



260036 3.95

3/8" FX 1/2" M ADAPTER

- Chrome vanadium alloy steel construction for strength and durability
- Polished nickel chrome plated finish resists corrosion



260048 4.95

3/8" DR UNIVERSAL JOINT

- Chrome vanadium alloy steel construction for strength and durability
- Polished nickel chrome plated finish resists corrosion



260045 6.95

3/8" FX 1/4" M ADAPTER

- Chrome vanadium alloy steel construction for strength and durability
- Polished nickel chrome plated finish resists corrosion



260049 3.95

3/8" DR 5/8" SP SOCKET

- Recessed edges
- Socket openings are designed to reduce fastener rounding
- Chrome vanadium alloy steel construction for strength and durability
- Polished nickel chrome plated finish resists corrosion
- Large stamping for quick identification
- Overall socket length: 3-1/4"



260050 9.95

3/8" DR 5/8" SP SOCKET

- Recessed edges
- Socket openings are designed to reduce fastener rounding
- Chrome vanadium alloy steel construction for strength and durability
- Polished nickel chrome plated finish resists corrosion
- Large stamping for quick identification
- Overall socket length: 3-5/16"



260051 9.95

1/2" DR UNIVERSAL JOINT

- Chrome vanadium alloy steel construction for strength and durability
- Polished nickel chrome plated finish resists corrosion



260025 6.95

1/2" FX 3/8" M ADAPTER

- Chrome vanadium alloy steel construction for strength and durability
- Polished nickel chrome plated finish resists corrosion



260028 4.95

- tires & wheels
- axles, hubs & springs
- tongue accessories
- hitches
- electrical
- brake parts
- trailer hardware
- locks & pins
- towing & loading
- tie downs
- tools
- chemicals

TRAILER

- tires & wheels
- axles, hubs & springs
- tongue accessories
- hitches
- electrical
- brake parts
- trailer hardware
- locks & pins
- towing & loading
- tie downs
- tools
- chemicals

TRAILER

1/4" DR QR TEARDROP RATCHET

- Quick Release feature for quick and easy socket changes
- Chrome vanadium alloy steel construction for strength and durability
- Polished nickel chrome plated finish resists corrosion
- 72 gear teeth



260034 20.95



3/8" DR QR TEARDROP RATCHET

- Quick Release feature for quick and easy socket changes
- Chrome vanadium alloy steel construction for strength and durability
- Polished nickel chrome plated finish resists corrosion
- Larger gear teeth for higher torque and added gear strength
- 72 gear teeth



260044 27.95



1/2" DR QR TEARDROP RATCHET

- Quick Release feature for quick and easy socket changes
- Chrome vanadium alloy steel construction for strength and durability
- Polished nickel chrome plated finish resists corrosion
- 72 gear teeth
- Larger gear teeth for higher torque and added gear strength
- 9 1/2" length



260023 35.95



3 PC 1/4" DR EXTENSION SET

- Chrome vanadium alloy steel construction for strength and durability
- Polished nickel chrome plated finish resists corrosion
- Sizes: 2", 3" and 6"



260041 8.95



4 PC 3/8" DR EXTENSION SET

- Chrome vanadium alloy steel construction for strength and durability
- Polished nickel chrome plated finish resists corrosion
- Sizes: 1-3/4", 3", 6" and 8"



260046 17.95



3 PC 1/2" DR EXTENSION SET

- Chrome vanadium alloy steel construction for strength and durability
- Polished nickel chrome plated finish resists corrosion
- Sizes: 3", 5" and 10"



260026 17.95



3 PC 3/8" DR WOBBLE EXT SET

- Chrome vanadium alloy steel construction for strength and durability
- Polished nickel chrome plated finish resists corrosion
- Sizes: 1-3/4", 3" and 8"



260047 15.95



3 PC 1/2" DR WOBBLE EXT SET

- Chrome vanadium alloy steel construction for strength and durability
- Polished nickel chrome plated finish resists corrosion
- Increased angle flexibility
- Sizes: 3", 5" and 10"



260027 20.95



1/2" DR 15" FLEX HANDLE

- Chrome vanadium alloy steel construction for strength and durability
- Polished nickel chrome plated finish resists corrosion
- 15" length



260024 16.95



1/4" DR UNIVERSAL JOINT

- Chrome vanadium alloy steel construction for strength and durability
- Polished nickel chrome plated finish resists corrosion



260035 5.95

1/4" FX 3/8" M ADAPTER

- Chrome vanadium alloy steel construction for strength and durability
- Polished nickel chrome plated finish resists corrosion



260036 3.95

3/8" FX 1/2" M ADAPTER

- Chrome vanadium alloy steel construction for strength and durability
- Polished nickel chrome plated finish resists corrosion



260048 4.95

3/8" DR UNIVERSAL JOINT

- Chrome vanadium alloy steel construction for strength and durability
- Polished nickel chrome plated finish resists corrosion



260045 6.95

3/8" FX 1/4" M ADAPTER

- Chrome vanadium alloy steel construction for strength and durability
- Polished nickel chrome plated finish resists corrosion



260049 3.95

3/8" DR 5/8" SP SOCKET

- Recessed edges
- Socket openings are designed to reduce fastener rounding
- Chrome vanadium alloy steel construction for strength and durability
- Polished nickel chrome plated finish resists corrosion
- Large stamping for quick identification
- Overall socket length: 3-1/4"



260050 9.95

3/8" DR 5/8" SP SOCKET

- Recessed edges
- Socket openings are designed to reduce fastener rounding
- Chrome vanadium alloy steel construction for strength and durability
- Polished nickel chrome plated finish resists corrosion
- Large stamping for quick identification
- Overall socket length: 3-5/16"



260051 9.95

1/2" DR UNIVERSAL JOINT

- Chrome vanadium alloy steel construction for strength and durability
- Polished nickel chrome plated finish resists corrosion



260025 6.95

1/2" FX 3/8" M ADAPTER

- Chrome vanadium alloy steel construction for strength and durability
- Polished nickel chrome plated finish resists corrosion



260028 4.95

- tires & wheels
- axles, hubs & springs
- tongue accessories
- hitches
- electrical
- brake parts
- trailer hardware
- locks & pins
- towing & loading
- tie downs
- tools
- chemicals

TRAILER

- tires & wheels
- axles, hubs & springs
- tongue accessories
- hitches
- electrical
- brake parts
- trailer hardware
- locks & pins
- towing & loading
- tie downs
- tools
- chemicals

TRAILER

1/4" DR QR TEARDROP RATCHET

- Quick Release feature for quick and easy socket changes
- Chrome vanadium alloy steel construction for strength and durability
- Polished nickel chrome plated finish resists corrosion
- 72 gear teeth



260034 20.95



3/8" DR QR TEARDROP RATCHET

- Quick Release feature for quick and easy socket changes
- Chrome vanadium alloy steel construction for strength and durability
- Polished nickel chrome plated finish resists corrosion
- Larger gear teeth for higher torque and added gear strength
- 72 gear teeth



260044 27.95



1/2" DR QR TEARDROP RATCHET

- Quick Release feature for quick and easy socket changes
- Chrome vanadium alloy steel construction for strength and durability
- Polished nickel chrome plated finish resists corrosion
- 72 gear teeth
- Larger gear teeth for higher torque and added gear strength
- 9 1/2" length



260023 35.95



3 PC 1/4" DR EXTENSION SET

- Chrome vanadium alloy steel construction for strength and durability
- Polished nickel chrome plated finish resists corrosion
- Sizes: 2", 3" and 6"



260041 8.95



4 PC 3/8" DR EXTENSION SET

- Chrome vanadium alloy steel construction for strength and durability
- Polished nickel chrome plated finish resists corrosion
- Sizes: 1-3/4", 3", 6" and 8"



260046 17.95



3 PC 1/2" DR EXTENSION SET

- Chrome vanadium alloy steel construction for strength and durability
- Polished nickel chrome plated finish resists corrosion
- Sizes: 3", 5" and 10"



260026 17.95



3 PC 3/8" DR WOBBLE EXT SET

- Chrome vanadium alloy steel construction for strength and durability
- Polished nickel chrome plated finish resists corrosion
- Sizes: 1-3/4", 3" and 8"



260047 15.95



3 PC 1/2" DR WOBBLE EXT SET

- Chrome vanadium alloy steel construction for strength and durability
- Polished nickel chrome plated finish resists corrosion
- Increased angle flexibility
- Sizes: 3", 5" and 10"



260027 20.95



1/2" DR 15" FLEX HANDLE

- Chrome vanadium alloy steel construction for strength and durability
- Polished nickel chrome plated finish resists corrosion
- 15" length



260024 16.95



1/4"

10 PC 1/4" DR 6 PT MET SOCKET SET

- Recessed edges
- Socket openings are designed to reduce fastener rounding
- Chrome vanadium alloy steel construction for strength and durability
- Polished nickel chrome plated finish resists corrosion
- Large stamping for quick identification
- Packaged on plastic slide rail for storage
- Sizes: 4, 5, 6, 7, 8, 9, 10, 11, 12, and 13mm



260037 13.95

10 PC 1/4" DR 6 PT SAE SOCKET SET

- Recessed edges
- Socket openings are designed to reduce fastener rounding
- Chrome vanadium alloy steel construction for strength and durability
- Polished nickel chrome plated finish resists corrosion
- Large stamping for quick identification
- Sizes: 5/32", 3/16", 7/32", 1/4", 9/32", 5/16", 11/32", 3/8", 7/16" and 1/2"
- Packaged on plastic slide rail for storage



260033 13.95

10 PC 1/4" DR 6 PT SAE DW SOCKET SET

- Recessed edges
- Socket openings are designed to reduce fastener rounding
- Chrome vanadium alloy steel construction for strength and durability
- Polished nickel chrome plated finish resists corrosion
- Large stamping for quick identification
- Packaged on plastic slide rail for storage
- Sizes: 5/32", 3/16", 7/32", 1/4", 9/32", 5/16", 11/32", 3/8", 7/16" and 1/2"



260038 23.95

10 PC 1/4" DR 6 PT MET DW SOCKET SET

- Recessed edges
- Socket openings are designed to reduce fastener rounding
- Chrome vanadium alloy steel construction for strength and durability
- Polished nickel chrome plated finish resists corrosion
- Large stamping for quick identification
- Packaged on plastic slide rail for storage
- Deep sizes: 4, 5, 6, 7, 8, 9, 10, 11, 12, and 13mm



260039 23.95

3/8"

3/8" DR SOCKETS 14MM/18MM

- Recessed edges
- Socket openings are designed to reduce fastener rounding
- Chrome vanadium alloy steel construction for strength and durability
- Polished nickel chrome plated finish resists corrosion
- Large stamping for quick identification



14mm **W886 4.95**

18mm **W890 5.95**



10 PC 3/8" DR SAE SOCKET SET

- Packaged on plastic slide rail for storage
- Recessed edges
- Socket openings are designed to reduce fastener rounding
- Chrome vanadium alloy steel construction for strength and durability
- Polished nickel chrome plated finish resists corrosion
- Sizes: 1/4", 5/16", 3/8", 7/16", 1/2", 9/16", 5/8", 11/16", 3/4" and 13/16"



260043 18.95

10 PC 3/8" DR SAE DW SOCKET SET

- Packaged on plastic slide rail for storage
- Recessed edges
- Socket openings are designed to reduce fastener rounding
- Chrome vanadium alloy steel construction for strength and durability
- Polished nickel chrome plated finish resists corrosion
- Deep sizes: 3/8", 7/16", 1/2", 9/16", 5/8", 11/16", 3/4", 13/16", 7/8" and 15/16"



260053 34.95

10 PC 3/8" DR MET SOCKET SET

- Packaged on plastic slide rail for storage
- Recessed edges
- Socket openings are designed to reduce fastener rounding
- Chrome vanadium alloy steel construction for strength and durability
- Polished nickel chrome plated finish resists corrosion
- Sizes: 10, 11, 12, 13, 14, 15, 16, 17, 18 and 19mm



260052 19.95

10 PC 3/8" DR MET DW SOCKET SET

- Packaged on plastic slide rail for storage
- Recessed edges
- Socket openings are designed to reduce fastener rounding
- Chrome vanadium alloy steel construction for strength and durability
- Polished nickel chrome plated finish resists corrosion
- Sizes: 10, 11, 12, 13, 14, 15, 16, 17, 18 and 19mm



260055 34.95

FAST SAME DAY SHIPPING

tires & wheels

axles, hubs & springs

tongue accessories

hitches

electrical

brake parts

trailer hardware

locks & pins

towing & loading

tie downs

tools

chemicals

TRAILER

1/2"

tires & wheels

axles, hubs & springs

tongue accessories

hitches

electrical

brake parts

trailer hardware

locks & pins

towing & loading

tie downs

tools

chemicals

9 PC 1/2" DR SAE SOCKET SET

- Recessed edges
- Socket openings are designed to reduce fastener rounding
- Chrome vanadium alloy steel construction for strength and durability
- Polished nickel chrome plated finish resists corrosion
- 6pt std. sizes: 1/2", 9/16", 5/8", 11/16", 3/4", 13/16", 7/8", 15/16" and 1"



260022 25.95



9 PC 1/2" DR MET SOCKET SET

- Recessed edges
- Socket openings are designed to reduce fastener rounding
- Chrome vanadium alloy steel construction for strength and durability
- Polished nickel chrome plated finish resists corrosion
- 6pt std. sizes: 12, 13, 14, 15, 16, 17, 18, 19 and 22mm



260029 25.95

8 PC 1/2" DR SAE DW SOCKET SET

- Recessed edges
- Chrome vanadium alloy steel construction for strength and durability
- Polished nickel chrome plated finish resists corrosion
- Large stamping for quick identification
- 6pt deep sizes: 1/2", 9/16", 5/8", 11/16", 3/4", 13/16", 7/8", and 15/16"



260030 37.95

8 PC 1/2" DR MET DW SOCKET SET

- Recessed edges
- Chrome vanadium alloy steel construction for strength and durability
- Polished nickel chrome plated finish resists corrosion
- Large stamping for quick identification
- 6pt deep sizes: 11, 12, 13, 14, 15, 16, 17, 18, and 19mm



260031 37.95

5PC 1/2" DR THIN WALL IMP SKT

- Protective sleeves and plastic inserts prevent scratching of wheels and lug nuts
- Hollow design allows room for removing longer bolts
- Color coded for easy identification
- Heavy duty chrome molybdenum
- Sizes Include: 17mm, 19mm (3/4), 21mm, 13/16 inch and 7/8 inch



260151 55.95

5 PC SP SOCKET SET

- Recessed edges
- Socket openings are designed to reduce fastener rounding
- Chrome vanadium alloy steel construction for strength and durability
- Polished nickel chrome plated finish resists corrosion
- Large stamping for quick identification
- SAE Sizes: 5/8, 3/4 and 13/16"
- Metric Sizes: 14 and 18mm



260021 21.95

TRAILER

9PC IMPACT SAE HEX BIT SOCKET SET

- Sizes include 1/4" Dr: 1/4, 5/16 & 3/8in
- Sizes include 3/8" Dr: 7/16, 1/2, 9/16, 5/8, 11/16 & 3/4in
- Includes socket storage rail Impact grade with oil resistant finish



260153 41.95



9PC IMPACT MET HEX BIT SOCKET SET

- Impact grade with oil resistant finish Includes socket storage rail
- Sizes include: 1/4" Dr: 6, 7, 8, & 10mm 3/8" Dr: 12, 14, 17, 18, & 19mm



260154 41.95



10PC IMPACT STAR BIT SOCKET SET

- Impact grade with oil resistant finish Includes socket storage rail
- 1/4" Dr: T10, T15, T20, T25, T27, & T30 3/8" Dr: T40, T45, T47, & T50



260152 40.95



10 PC SAE HEX BIT SOCKET SET

- Chrome vanadium steel construction
- Heat treated for strength
- Bonus storage rail included
- SAE sizes: 3/32", 7/64", 1/8", 9/64", 5/32", 3/16", 7/32", 1/4", 5/16" and 3/8"



260015 20.95

10 PC MET HEX BIT SOCKET SET

- Chrome vanadium steel construction
- Heat treated for strength
- Bonus storage rail included
- Metric sizes: 2, 3, 4, 5, 5.5, 6, 7, 8, 9 and 10mm



260016 20.95

12 PC STAR BIT SOCKET SET

- Packaged on plastic slide rail for storage
- Chrome vanadium alloy steel construction for strength and durability
- Polished nickel chrom plated finish resists corrosion
- 1/4" Drive sizes: T10, T15, T20, T25, T27 and T30
- 3/8" Drive sizes: T40, T45, T47, T50 and T55
- 1/2" Drive sizes: T60



260056 26.95

- tires & wheels
- axles, hubs & springs
- tongue accessories
- hitches
- electrical
- brake parts
- trailer hardware
- locks & pins
- towing & loading
- tie downs
- tools
- chemicals

TRAILER

TOOLS

- tires & wheels
- axles, hubs & springs
- tongue accessories
- hitches
- electrical
- brake parts
- trailer hardware
- locks & pins
- towing & loading
- tie downs
- tools
- chemicals

10 PC T-HANDLE STAR KEY SET

- 10 piece t-handle stardriver set
- Heat treated alloy steel shafts
- Plastic grips add comfort and turning power
- Bonus storage tray mounts on wall or bench

Sizes:
T7, T8, T9,
T10, T15, T20,
T25, T27, T30,
T40



W80276 23.95



10 PC T-HANDLE HEX KEY SET

- Heat treated alloy steel shafts
- Plastic grips add comfort and turning power
- Bonus storage tray mounts on wall or bench

SAE

SAE sizes: 3/32", 7/64",
1/8", 9/64", 5/32", 3/16",
7/32", 1/4", 5/16", and 3/8"
Master 10 inner 1

METRIC

METRIC sizes: 2, 2.5, 3, 4,
4.5, 5, 5.5, 6, 8 & 10mm
Master 10 inner 1



W80274 19.95



W80275 19.95

30 PC HEX KEY SET

- Long and short shank hex keys
- Alloy steel construction
- Includes handy organizer
- 15 Metric hex keys, sizes: .7, .9, 1.3, 1.5, 2, 2.5, 3, 4, 4.5, 5, 5.5, 6, 7, 8 and 10mm
- 15 SAE hex keys, sizes: .028, .035, .050, 1/16, 5/64, 3/32, 7/64, 1/8, 9/64, 5/32, 3/16, 7/32, 1/4, 5/16, and 3/8"



260063 17.95

8 PC HEAVY DUTY HEX KEY SET

- Tough, chrome plated steel
- Includes handy key ring style holder to keep keys organized
- Metric sizes: 2, 2.5, 3, 4, 5, 6, 8 and 10mm



W1113 7.95



TRAILER

22 PC SAE/MET BALL END HEX

- Alloy steel construction.
- Ball end wrenches are perfect for quick and convenient access to screw heads at angles up to 25 degrees
- Includes plastic holder for storage
- SAE sizes: 0.05, 1/16", 5/64", 3/32", 7/64", 1/8", 9/64", 5/32", 3/16", 7/32", 1/4", 5/16" and 3/8"
- Sizes: 1.5, 2, 2.5, 3, 4, 5, 6, 8 and 10mm



260062 14.95

BALL END ALLEN SET

- Made of chrome-vanadium tool steel
- Ball end allows for better access to allen-head bolts (up to 25° working angle)
- Convenient holder included
- Sizes: 1.5, 2, 2.5, 3, 4, 5, 6, 8 and 10mm



678185 20.99



3 PC ALUMINUM HEX & STAR KEY SET

- Lightweight anodized aluminum body and chrome vanadium steel construction for strength and durability
- Ball end on hex keys allow use at angles up to 25° for obstructed areas
- Star keys work on regular and tamper proof star fasteners
- Keys conveniently fold for compact easy storage
- Coded in high visibility colors for easy identification



SAE HEX KEY SIZES:
1/16", 5/64", 3/32", 1/8", 9/64", 5/32", 3/16"
and 1/4"

METRIC HEX KEY SIZES:
1.5, 2, 2.5, 3, 4, 5, 6 and 8mm

STAR KEY SIZES:
T9, T10, T15, T20, T25, T27, T30 and T40



260064 20.95

HIGH VISIBILITY LED BIT DRIVER

- Three bright white LEDs illuminate your work area
- Ergonomic non-slip molded handle
- On-board bit storage Includes #1, #2 Phillips bits, and 3/16" and 1/4" slotted bits
- Sold each



260148 11.95

MINI MULTI TOOL W/ MERCH STRIP

- Stainless steel multi tool features spring loaded plier jaws, wire cutters, slotted and Phillips screwdrivers, knife blades, bottle opener, nail file and more
- Handy in your pocket, purse, glove box or tool kit
- Lightweight and durable



260058 14.95

METRIC MULTI-PURPOSE TOOL

- A must-have for on-the-trail repairs or adjustments
- Can be used to remove 8mm, 10mm, 12mm and 14mm bolts, No. 2 & No. 3 Phillips screws, small and medium straight-slot screws and 5mm and 6mm allen bolts
- Includes a 1/4" and 3/8" socket driver
- 10mm and 12mm 1/4" drive sockets included
- Includes convenient carrying case
- Hard nickel pewter finish
- Perfect for any tool pack
- Enhance it by adding your own 1/4" or 3/8" drive socket attachments



678030 76.99

POCKET SCREWDRIVER COMBO

- Phillips and slotted screwdriver bits
- Phillips: #1 and #2
- Slotted: 3/16 and 1/4"
- Built in level
- Mini LED light
- Convenient pocket clip
- Includes 3 LR44 batteries

Red, Blue or Yellow
(Our Choice of Color)

W9161 4.95



Buy 12 and get a free display



- tires & wheels
- axles, hubs & springs
- tongue accessories
- hitches
- electrical
- brake parts
- trailer hardware
- locks & pins
- towing & loading
- tie downs
- tools
- chemicals

TRAILER

- tires & wheels
- axles, hubs & springs
- tongue accessories
- hitches
- electrical
- brake parts
- trailer hardware
- locks & pins
- towing & loading
- tie downs
- tools
- chemicals

8 PIECE PROFESSIONAL SCREWDRIVER SET

- Oversize handles for easy use
- Magnetic tips
- Contains Phillips #1 X 3", #2 X 1-1/2", #2 X 4", Slotted 3/16" X 3", 1/4" X 1-1/2", 1/4" X 4", Star T-15, T-20 X 4"



W80008 13.95



6 PIECE SCREWDRIVER SET

- Oversized comfort grips for more turning power
- Heat treated alloy steel blades for durability
- Plated shafts for corrosion resistance
- Contents: 3pcs Phillips screwdrivers and 3pcs Slotted screwdrivers



W1703 15.95



7 IN 1 STUBBY BIT DRIVER

- High torque ratchet
- 6 bits stored in handle
- Available in 4 colors



W38927 12.95



7 PIECE PROFESSIONAL SCREWDRIVER SET

- Seven piece screwdriver set
- Phillips sizes: #1 x 3" and #2 x 4"
- Slotted sizes: 3/16 x 4", 1/4 x 4", 1/8 x 4" and 3/8 x 8"
- #1 x 3", #2 x 4" Phillips



W80007 14.95



TRAILER

IMPACT DRIVER/BIT SET



- Ideal for loosening firmly tightened or rusted screws or bolts
- Removable hex adaptor allows use with 3/8" drive sockets and accessories
- Heavy duty blow molded storage case
- Phillips sizes: #2 and #3
- Flat sizes: 5/16" and 3/8"



Impact Driver / Bit Set	W2500	19.95
Repl. 4 Piece Bit Set (Carded)	EM03801	3.95

HEAVY DUTY IMPACT DRIVER WITH SHORT BIT SET



- Heavy duty design for general shop use
- Tightens or loosens screws or bolts on impact
- Complete with four bits and metal storage case
- 3/8" square drive

824744 33.95



100 PC BIT SET

- Use with screwdrivers, electric drills or socket wrenches
- Includes bit adapters, magnetic bit holder, "Y" style bits, couplers, Phillips, pozi, square, slotted, spanner, star, torque, tamper resistant star, hex triwing, clutch head and spline bits



260073 20.95



7 PC CHISEL & PUNCH SET

- Hardened and tempered high carbon steel construction
- Vinyl covered shank absorbs shock and reduces vibration
- Handy storage pouch
- Pin punch sizes: 3/16 x 6"
- Taper punch sizes: 1/8" and 3/16 x 6"
- Center punch sizes: 3/8"
- Cold chisel sizes: 3/8", 1/2" and 5/8"



260061 14.95



3 PIECE DUAL CUSHION ADJUSTABLE WRENCH SET

- Soft cushion grips with ergonomic shape for safe easy use
- Precision SAE and Metric rule on wrench heads for accuracy
- SAE box ends in handles: 3/8, 9/16 and 3/4"
- Machine polished finish and drop forged for long life



W30703 44.95

TIPROLIGHT™ TITANIUM WRENCHES

- These super-light wrenches weigh less than one quarter of the weight of standard steel wrenches
- Made from tool-grade titanium alloy
- Extremely lightweight and compact design is perfect for trail tool packs
- Exclusive Motion Pro design for optimized strength and performance
- Titanium alloy will never rust or corrode
- Ergonomic handle
- Laser etched markings for easy identification
- Designed by Motion Pro
- Sets of 4 include heavy-duty nylon tool wrap
- Patented



DESCRIPTION	PART #	
8mm	142366	30.99
10mm	142367	34.99
12mm	142368	47.99
13mm	142369	52.99
14mm	142370	56.99
Set of 4 (8,10,12, & 14mm)	142371	165.99
Set of 4 (8,10,12, & 13mm)	142382	165.99

11 PIECE FULL POLISH COMBINATION WRENCH SETS



- Fully polished chrome vanadium steel construction
- SAE sizes: 1/4", 5/16", 3/8", 7/16", 1/2", 9/16", 5/8", 11/16", 3/4", 13/16", 7/8"
- Metric sizes: Metric sizes: 9, 10, 11, 12, 13, 14, 15, 16, 17, 18 and 19
- Handy storage rack with easy to carry handle

DESCRIPTION	PART #	
SAE	W1061	25.95
Metric	W1062	25.95



- tires & wheels
- axles, hubs & springs
- tongue accessories
- hitches
- electrical
- brake parts
- trailer hardware
- locks & pins
- towing & loading
- tie downs
- tools
- chemicals

TRAILER

- tires & wheels
- axles, hubs & springs
- tongue accessories
- hitches
- electrical
- brake parts
- trailer hardware
- locks & pins
- towing & loading
- tie downs
- tools
- chemicals

3 PC LOCK GRIP PLIERS SET



- Drop forged steel construction
- Hardened and tempered milled teeth
- Wire cutters and quick release levers
- Includes three popular sizes - 5", 7" and 10"

260010 26.95



7 PIECE DUAL CUSHION PLIER SET



- Set includes: 10" groove joint pliers, 7-1/2" diagonal cutter, 8" long nose pliers, 8" slip joint pliers, 4-1/2" diagonal cutter, bent nose and end nipper pliers

W30759 54.95



9-1/2" GROOVE JOINT PLIERS

- Drop forged steel
- Cushion grips
- Fully polished head



260011 10.95

120 PC HEAT-SHRINK TUBING SET

- Sizes include: 5/32", 3/16", 9/32" and 5/16" diameters
- Set includes: Five different colors with 15 pieces of each size
- Set color-codes; positive, negative and ground for easy identification
- 100% polyolefin construction, UL listed
- Handy divided container keeps pieces organized



260144 7.95

SOLDERING GUN KIT

- Built in spotlight Instant heat
- Includes: Soldering gun, extra soldering wire, soldering paste and extra tip
- Electrical Rating: 120V~ / 60Hz / 60 W.
- Maximum temperature: 1135°F
- Extra tip
- Display packaged



260119 34.95



TRAILER

TMV SAFETY WIRE PLIERS

- Safety wire pliers
- Easily secure grips with this handy tool



631536 54.95



TMV STAINLESS STEEL SAFETY WIRE

- Roll of safety wire
- For use with 631536 safety wire pliers
- Easily secure your grips in place



631537 21.95



WIRE CRIMPING TOOL

- Wire cutter, bolt cutter, terminal crimper, wire stripper in 1 handy tool
- Includes assorted terminals
- Display packaged



W190 6.95

7 WAY CRIMPING TOOL

- Wire cutter, terminal crimper and wire stripper in one handy tool
- Black anodized finish with insulated grips
- Crimp slot on end of tool secures most ignition terminals including "W" type, right angle and "High Tower" terminals
- Crimps 7 mm to 8.5mm ignition wire
- Works with 10 to 22 gauge solderless terminals

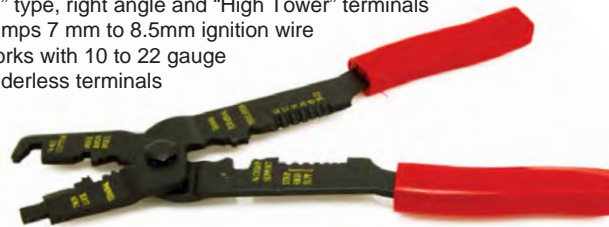

W86500 17.95

CUT & PULL WIRE STRIPPERS

- Cuts and removes insulation from wire with a single squeeze of the handle
- Accepts 18, 14, 12, 10 and 8 GA AWG wire



W200 18.95



2-IN-1 WIRE STRIPPER/CRIMPER

- Two tools in one - Stripper and Crimper
- One end features a professional grade stripper for AWG sizes 10, 12, 14, 16, 18 and 20 Gauge wire
- Flip the handles around and you have a full range crimper for 22-18, 16-10 and 310/311/410/411 size terminals
- Precision machined and hardened jaws
- Three position safety lock: open to switch, lock to hold on position, closed to prevent operation
- Comfortable non-slip grips
- Sold each



260115 28.95



9.5" CRIMPING PLIERS

- Ergonomic non-slip molded grips for improved comfort and control
- Premium quality drop forged and hardened chrome vanadium steel Induction hardened and precision sharpened cutting edges Slim nose shape for tight places
- Designed for crimping of both insulated and non-insulated solderless connections and terminals, as well as cutting 10-22 AWG wire
- Display packaged
- Sold each



260150 19.95



tires & wheels

axles, hubs & springs

tongue accessories

hitches

electrical

brake parts

trailer hardware

locks & pins

towing & loading

tie downs

tools

chemicals

TRAILER

- tires & wheels
- axles, hubs & springs
- tongue accessories
- hitches
- electrical
- brake parts
- trailer hardware
- locks & pins
- towing & loading
- tie downs
- tools
- chemicals

40 PIECE TAP & DIE SETS

- Tap wrench, T-handle tap wrench, die stock, screwdriver and screw pitch gauge
- NC, NF and NPT sizes
- 17 taps and 17 dies
- Storage case



DESCRIPTION	PART #	
SAE	W4001	46.95
Metric	W4002	46.95



HEAVY DUTY NUT SPLITTER

- Removes rusted, stripped, and stubborn nuts
- Self-centering wobble tip
- Offset design for easier operation
- Splits nuts 7/16" to 3/4"
- Drop forged steel construction
- Plated to resist corrosion
- Heat treated chisel



W88030 18.95

5 PC TAPERED EXTRACTOR SET

- Removes broken studs, screws, bolts, pipes and pipe fittings
- Chrome vanadium steel
- Features flutes for more positive grip
- Includes handy organizer
- Sizes: 1/8", 3/16", 15/64", 5/16" and 3/8"



260094 6.95

67 PIECE HAND RIVETER SET

- Includes riveter with 4 nozzles
- 15 each of the following rivets: 3/32", 1/8", 5/32" and 3/16"



W2017 17.95

8 PIECE SPECIALTY PICK & DRIVER SET

- Chrome vanadium steel shafts with magnetic tips
- High visibility PVC handles
- Contains: curved hook, offset 45° hook, 90° hook, straight pick, 1/8 in. slotted screwdriver, #0 Phillips screwdriver, T-15 star driver and T-20 star driver



W941 7.95

3 PC STEP DRILL SET

- 1/4" hex shank 3 bit set replaces 17 individual drill bits
- Titanium nitride coated high speed steel
- For use with metal, wood and plastic
- Starts on contact, no center punch needed
- Automatically deburs holes as you drill
- 6 step: 3/16", 1/4", 5/16", 3/8", 7/16", 1/2"
- 9 step: 1/4", 5/16", 3/8", 7/16", 1/2", 9/16", 5/8", 11/16", 3/4"
- 13 step: 1/8", 5/32", 3/16", 7/32", 1/4", 9/32", 5/16", 11/32", 3/8", 13/32", 7/16", 15/32", 1/2"



260091 18.95

29 PC DRILL BIT SET W/STEEL CASE

- Durable titanium nitride coated high speed steel
- Sizes: 1/16" through 1/2" in 64th increments
- Handy steel storage box included



260092 51.95

TRAILER



AUTOMATIC DISTRIBUTORS

TUFF HOOK™

682208 59.99



- Heavy-duty design for use on large exhaust and kickstand springs
- Multi-function tip easily pulls or pushes large springs on and off mounts
- Flexing shaft is ideal for hard to reach springs with minimal working space
- Locking shaft slider allows the center of the shaft to be rigid or flex
- A must have for UTV and snow machine exhaust systems
- Billet aluminum construction handle and locking shaft slider
- Steel shaft with heavy-duty stainless steel flex insert
- Lifetime Limited Warranty



MINI SPRING HOOK TOOL



- Ergonomic handle provides a secure grip at every angle
- For use on exhaust pipe springs, seat or tank holding springs, cotter pins, side stand springs and more

144166 8.99



HEAVY DUTY SPRING HOOK

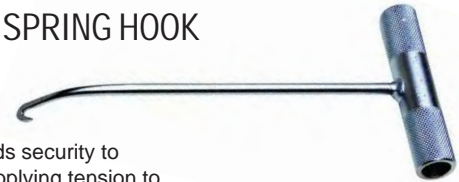

- The T-handle adds security to your grip when applying tension to the spring
- Used to remove exhaust pipe springs, seat or tank holding springs, cotter pins, sidestand springs and other parts

678127 14.99



SPRING HOOK

- Exhaust spring tool with rubber coated handle

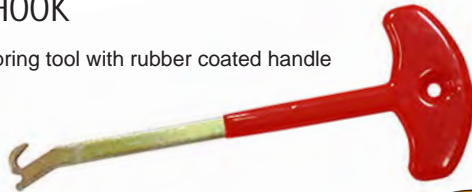

6212206 20.95



DELUXE SPRING TOOL

- Exhaust spring tool



214091 21.74



DELUXE SPRING TOOL MULTI-PAK

- Contains a selection of exhaust spring hook tools
- 26.5 cm (10-1/2") curved tool with perpendicular hook
 - 31 cm (12-1/4") angled tool with parallel hook
 - 25 cm (9-3/4") straight tool with parallel hook
 - 14 cm (5-1/2") straight tool with parallel hook
 - 14 cm (5-1/2") straight tool with perpendicular hook



214092 48.32



2 PIECE SPECIALTY PICK SET

- Hardened tips and knurled center grips
- Also useful for retrieving small parts, nuts, washers, etc.
- Contains 90° double end scribe for etching metals and soft materials O-ring & Seal Pick for easily removing & installing O-rings & seals
- Carded



W80750 5.95



- tires & wheels
- axles, hubs & springs
- tongue accessories
- hitches
- electrical
- brake parts
- trailer hardware
- locks & pins
- towing & loading
- tie downs
- tools
- chemicals

TRAILER

TOOLS

- tires & wheels
- axles, hubs & springs
- tongue accessories
- hitches
- electrical
- brake parts
- trailer hardware
- locks & pins
- towing & loading
- tie downs
- tools
- chemicals

CLAW & MAGNETIC RETRIEVERS

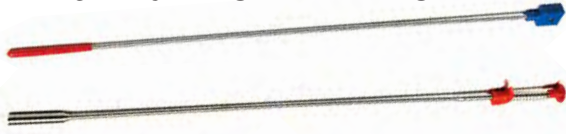

- Pick up small items from confined areas with its flexible shaft
- Strong durable magnets and powerful claws for easy retrieval
- Carded

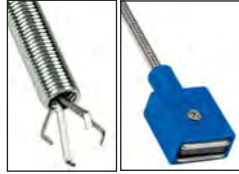

24" Retriever Claw	W1184	4.95
24" Magnetic Retriever	W1182	3.95

SWIVEL INSPECTION MIRROR

- 2" round mirror with multi-direction swivel for visual access to confined areas
- Chrome plated corrosion resistant shaft extends from 11-1/2" to 18"
- Vinyl grip



W1262	5.95
-------	------

POCKET MAGNETIC RETRIEVER

- Extends from 4 3/4" to 18 1/2"
- Convenient pocket clip
- Easily retrieves small parts from confined areas



W1261	2.95
-------	------

8 LB. MAGNETIC PICKUP TOOL

- Heavy duty magnetic tip retrieves objects up to 8 lbs.
- Retriever extends over 24"
- Cushion grip handle
- Handy pocket clip



W9101	4.95
-------	------

MAGNETIC TRAYS

- High quality heavy duty magnet
- Sticks to almost any metal surface
- Keeps small metal parts and tools from getting lost or misplaced
- Very handy even sideways or upside-down



6" Round	W1264	5.95
9.5" x 5.5" Oblong	W1265	11.95



3 PIECE INSPECTION TOOL SET

- Includes lighted magnetic pick-up tool, telescoping inspection mirror and mini magnetic parts tray
- Lighted magnetic pick-up tool: lifts up to 8 lbs., has a bright LED light; extends from 6-1/2" to 33"
- Telescoping inspection mirror: extends from 6-1/2" to 19" and has a 2" round mirror
- Both have a cushion grip handle and a handy pocket clip



W1932	18.95
-------	-------

TRAILER

6" COMPOSITE DIGITAL CALIPER

- Rugged impact resistant composite material
- Easy to read SAE and metric LCD display
- Low battery warning with 12 month average battery life
- Includes 1.5V button cell battery
- Specifications: accuracy +/- .001" (.2mm)
- Resolution: 0.0005"/0.01mm
- Temperature operating range: 32° F to 104° F
- Overall length: 9-1/2"
- Throat depth: 1-9/16"



260098	18.95
--------	-------

DIGITAL CALIPER



- Measures outside, inside, step and depth
- 0" to 6" SAE range
- 0mm to 150mm metric range
- SAE to metric conversion
- Large easy to read LCD display
- Zero setting at any position within measuring range
- Thumb wheel with lock
- Battery included



W80152	37.95
--------	-------

6" PLASTIC CALIPER

- 4 way measurements for outside, inside, step and depth



260093	4.95
--------	------

CARBON & GASKET SCRAPER

- Alloy steel construction
- Plated to resist corrosion



W234 5.95

UTILITY KNIFE & BLADES

- 3 position retractable blade
- Extra blade included stores in handle
- Indispensable around the home, shop & office



Knife	W745	4.95
Blades (5)	W744	1.95

MINI RAZOR SCRAPER

- Perfect at scraping labels & paint over spray off glass surface
- Tough polypropylene construction
- Protective safety cap
- Ergonomic grip for greater comfort & control
- Includes one standard razor blade



260060 5.95



FOLDING LB UTILITY KNIFE

- Strength of a fixed blade w/convenience of pocket knife
- Change blades with the push of a button
- Compact design folds down to 3 9/16" for easy storage & portability
- Blade locks in open position for safety
- Handy belt clip
- Available in red or blue handle



RED HANDLE
260017 10.95

BLUE HANDLE
260018 9.95

100 PK UTILITY KNIFE BLADES

- Easy to use blade dispenser
- Fits standard utility knives
- Heavy duty blades precision honed to razor edge Indispensable around the home, shop & office
- Includes 100 blades
- Display packaged



260145 13.95

BREAKAWAY UTILITY KNIFE



- Retractable blade with automatic lock
- End cap detaches to safely break blade tips
- Yellow in color

W972 1.95



50PK BX5 UTILITY KNIFE BLADES

- High quality SK2 steel lasts up to 5X longer than standard steel blades
- Easy to use blade dispenser
- Fits standard utility knives
- Heavy duty blades precision honed to razor edge Indispensable around the home, shop & office
- Display packaged



260146 22.95

- tires & wheels
- axles, hubs & springs
- tongue accessories
- hitches
- electrical
- brake parts
- trailer hardware
- locks & pins
- towing & loading
- tie downs
- tools
- chemicals

TRAILER

TOOLS

- tires & wheels
- axles, hubs & springs
- tongue accessories
- hitches
- electrical
- brake parts
- trailer hardware
- locks & pins
- towing & loading
- tie downs
- tools
- chemicals

TRAILER

16 OZ. BALL PEIN HAMMER

- Drop forged high carbon steel head
- Heavy duty hardwood handle



260012 10.95



4 LB. SLEDGE HAMMER

- Heavy duty fiberglass handles for strength and durability
- Anti-shock, rubber cushion grips
- Mirror polish heads



260009 24.95



8 OZ. RUBBER Mallet

- Rubber head
- Tubular chrome plated handle
- Rubber grip for comfort
- Many uses around home and shop



260014 5.95



16 OZ. RUBBER Mallet

- Rubber head
- Tubular chrome plated handle
- Rubber grip for comfort
- Many uses around home and shop



260013 6.95



6" QUICK RELEASE C-CLAMP

- Tough enamel finish
- Chrome plated screw threads
- Precision crafted for smooth operation
- Features quick-release button to save time and twisting
- Malleable iron construction



260080 20.95



25' X 1" SAE/MET TAPE MEASURE

- Convenient and quick fractional readout every 1/8"
- Both SAE and Metric markings on tape measure blade
- Durable casing stands up to rough treatment
- Easy to find bright color



260059 10.95



3 PC PRY BAR SET

- Curved blade design provides extra leverage
- Capped ends allow user to strike with a hammer without damaging the head
- Blade protection for added safety
- Sizes: 8", 12" and 17-3/4"



260020 16.95



4-1/2" ANGLE GRINDER

- 5/8-11 spindle for mounting the most popular accessories
- 2-position side handle
- Powerful 5 Amp motor
- 11,000 RPM no-load speed
- Includes: 4-1/2" grinding wheel, side handle
- Metal gear case dissipates heat for longer life
- Spindle lock for quick wheel/blade changes



260087 57.95

- tires & wheels
- axles, hubs & springs
- tongue accessories
- hitches
- electrical
- brake parts
- trailer hardware
- locks & pins
- towing & loading
- tie downs

COMBO FINGERNAIL BRUSH W/MAGNET

- Combination fingernail, hand and utility brush
- Contoured handle for better grip



260071 3.95

2" FINE CUPPED WIRE BRUSH



- Fine 1/4" shank
- Use with any power drill
- Many utility cleaning uses at home and shop



W1212 4.95

UTILITY WIRE BRUSH

- Solid wood handle
- Steel bristles
- Cleans rust, paint, dirt, and much more, quickly and easily
- Carded



W1152 2.95

GRUNGE BRUSH™

Chain and gear cleaning has never been faster or easier! Scrub the chain with the horseshoe shaped bristles at one end of The Grunge Brush™ to clean all four sides of the chain. Use the long bristles on the other end of the brush to clean components like sprockets, derailleurs, cranksets, brakes and pedals.

Regular component cleaning prevents premature wear and tear on chain and sprockets, eliminates chain skipping caused by dirt and grunge, and assures smooth operation of drivetrain and brakes.

The Grunge Brush™ can be used dry or for deep cleaning action, use it with Citrus Bike Chain Degreaser or Multi Bike Degreaser, by simply spraying degreaser onto the chain or directly onto bristles. Grunge Brush™ scrubbing action, coupled with a Finish Line bike degreaser, will leave your drivetrain looking like new



GRUNGE BRUSH COMBO PACK With Cleaner

SS900 19.95



REPLACEMENT BRUSH SET

SS400 5.95



- tools
- chemicals

TRAILER

tires & wheels

axles, hubs & springs

tongue accessories

hitches

electrical

brake parts

trailer hardware

locks & pins

towing & loading

tie downs

tools

chemicals

TRAILER

DUCT TAPE

- 1-7/8" x 30'
- Sold each



W3103 3.95



3 IN 1 STAPLER

- Easy slide open staple loading feature
- Easy smooth squeeze
- Handy storage case
- Comfort grip handle for extended use
- Includes 300 staples, 300 nails and 300 U-Shaped staples



260076 18.95



PVC ELECTRICAL TAPE

- Black
- Heavy gauge 7 mil. thermo-plastic UL approved for insulation of splices in insulated conductors of 5000 volt rating



SIZE	PART #	
3/4" x 30'	W501	1.95
3/4" x 60'	W502	2.95



CABLE TIES



- Black
- Cold resistant / UV resistant
- Sold in 100-pack
- Min. operating temperature -40°C / -40°F
- Min. installation temperature -20°C / -04° F



LENGTH (MM)	(INCH)	WIDTH (MM)	Max. Bundle Dia. (MM)	Min Loop Tensile Strength		PART #
				LBS	KGS	
150	6"	3.6	36	40	18	129196 10.00
203	8"	4.8	52	50	22	129197 15.00
250	10"	4.8	68	50	22	129198 20.95
380	15"	7.6	105	120	55	129199 61.95

CABLE TIES - 100 PIECE



- 100 piece cable ties
- 8" length
- Tensile strength 40 lbs.
- Resealable bag
- 100 piece

COLOR	PART #	
WHITE	260082	3.95
BLACK	260083	2.95



50 PC 11" CABLE TIES

- 1/8" wide x 11" long
- 25 white and 25 black
- UL approved nylon



260081 3.95



MULTI-PURPOSE CABLE TIES

HANDY ASSORTMENTS FOR THE HOME, OFFICE, OR SHOP

- 1000 piece cable tie assortment
- Four lengths, color coded
- (500) 4", (100) 6", (300) 8" and (100) 12" cable ties
- Great for home, shop, office, RV, boat and so much more



W2925 21.95

MULTI-PURPOSE CABLE TIES

HANDY ASSORTMENTS FOR THE HOME, OFFICE, OR SHOP

250 Piece Package



W2918 7.95

HARDWARE ASSORTMENTS



200 PC SPRING ASSORTMENT



W5200 12.95

560 PC COTTER PIN ASSORTMENT



W5205 14.95

150 PC COTTER PIN ASSORTMENT



W5206 19.95

150 PC HAIR PIN ASSORTMENT



W5210 11.95

300 PC E-CLIP ASSORTMENT



W5208 13.95

300 PC SNAP RING ASSORTMENT



W5212 13.95

26 PC HOSE CLAMPS



W5348 11.95

347 PC NUT & BOLT ASSORTMENT - METRIC



W5221 11.95

70 PC GREASE FITTING ASSORTMENT



W5218 10.95

200 PC HEX HEAD DRILL SCREW ASSORTMENT



W5220 14.95

1200 PC NUT, BOLT, & WASHER ASSORTMENT



W5226 56.95

720 PC WASHER ASSORTMENT

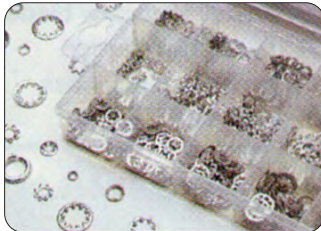

W5215 16.95

500 PC RIVET ASSORTMENT



W5228 17.95

150 PC WING NUT ASSORTMENT



W5219 15.95

347 PC NUT & BOLT ASSORTMENT - SAE



W5221 11.95

285 PC MULTI-USE ELECTRICAL REPAIR KIT



W5207 61.95

160 PC WIRE TERMINAL ASSORTMENT



W52131 19.95

120 PC FUSES

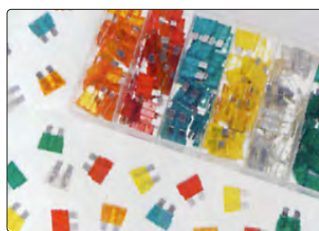

W5368 13.95

120 PC MINI BLADE STYLE FUSE ASSORTMENT



260088 14.95

- tires & wheels
- axles, hubs & springs
- tongue accessories
- hitches
- electrical
- brake parts
- trailer hardware
- locks & pins
- towing & loading
- tie downs
- tools
- chemicals

TRAILER

FAST SAME DAY SHIPPING

- tires & wheels
- axles, hubs & springs
- tongue accessories
- hitches
- electrical
- brake parts
- trailer hardware
- locks & pins
- towing & loading
- tie downs
- tools
- chemicals



METRIC KIT REPLACEMENT HARDWARE

Priced per package • Sold in packages of 10 only • All the popular metric nuts, bolts washers that fit your atv, motorcycle and snowmobile



DESCRIPTION & (HEAD SIZE)	PART #	
Nut, 5mm (8mm)	MP0005	0.80
Nut, 6mm (10mm)	MP0006	1.23
Nut, 12mm (17mm)	MP0012	3.83
Nut, Fuji-Lock 8mm (13mm)	MP0308	4.99
Nut, Fuji-Lock 10mm (17mm)	MP0310	6.50
Washer, Lock 4mm	MP2004	0.89
Washer, Lock 5mm	MP2005	1.71
Washer, Lock 10mm	MP2010	1.80
Washer, Lock 12mm	MP2012	3.55
Bolt, m5x20 (8mm)	MP0520	1.49
Bolt, m5x30 (8mm)	MP0530	4.05
Bolt, m10x20 (14mm)	MP1020	7.59
Bolt, m10x30 (14mm)	MP1030	11.01
Bolt, m10x35 (14mm)	MP1035	9.99
Bolt, m10x40 (14mm)	MP1040	11.39
Bolt, m10x45 (14mm)	MP1045	12.50
Bolt, m10x50 (14mm)	MP1050	12.50
Bolt, Flange m6x40 (8mm)	MP1640	2.49
Bolt, Flange m6x45 (8mm)	MP1645	2.99
Screw, Allen Head m8x20	MP2820	5.80
Screw, Allen Head m8x25	MP2825	6.29
Screw, Allen Head m8x35	MP2835	5.50
Screw, Allen Head m8x40	MP2840	5.89
Nut, Flange 8mm (12mm)	MP0108	2.23
Nut, Flange 10mm (14mm)	MP0110	2.86
Nut, Flange 12mm (17mm)	MP0112	3.83

DESCRIPTION & (HEAD SIZE)	PART #	
Nut, Acorn 5mm (8mm)	MP0405	1.70
Nut, Acorn 10mm (14mm)	MP0410	4.17
Bolt, m6x35 (10mm)	MP0635	2.49
Bolt, m6x40 (10mm)	MP0640	2.75
Bolt, m6x45 (10mm)	MP0645	4.17
Bolt, m6x50 (10mm)	MP0650	2.50
Bolt, m12x20 (17mm)	MP1220	14.20
Bolt, m12x30 (17mm)	MP1230	16.15
Bolt, Flange m8x35 (10mm)	MP1835	3.99
Bolt, Flange m8x50 (10mm)	MP1850	5.25
Screw, Pan Head m6x8	MP3608	1.99
Screw, Pan Head m6x12	MP3612	2.25
Screw, Pan Head m6x20	MP3620	2.75
Screw, Pan Head m6x30	MP3630	3.25
Screw, Pan Head m6x35	MP3635	3.60
Screw, Pan Head m6x40	MP3640	3.99
Screw, Pan Head m6x45	MP3645	4.10
Screw, Pan Head m6x50	MP3650	4.39
Screw, Pan Head m6x55	MP3655	7.74
Screw, Pan Head m6x60	MP3660	8.20
Nut, Nylock 4mm (7mm)	MP0204	0.99
Nut, Nylock 5mm (8mm)	MP0205	0.99
Nut, Nylock 10mm (14mm)	MP0210	4.64
Washer, Flat 4mm	MP1004	0.60
Bolt, m4x15 (12mm)	MP0415	1.35

DESCRIPTION & (HEAD SIZE)	PART #	
Bolt, m4x25 (12mm)	MP0425	3.55
Bolt, m8x10 (12mm)	MP0810	4.17
Bolt, m8x15 (12mm)	MP0815	3.30
Bolt, m8x20 (12mm)	MP0820	3.25
Bolt, m8x25 (12mm)	MP0825	3.49
Bolt, m8x30 (12mm)	MP0830	3.50
Bolt, m8x35 (12mm)	MP0835	5.80
Bolt, m8x40 (12mm)	MP0840	4.50
Bolt, m8x45 (12mm)	MP0845	6.43
Screw, Allen Head m6x35	MP2635	4.85
Screw, Allen Head m6x40	MP2640	4.85
Screw, Allen Head m6x50	MP2650	5.57
Screw, Allen Head m6x60	MP2660	6.75
Screw, Pan Head m5x10	MP3510	1.25
Screw, Pan Head m5x12	MP3512	1.75
Screw, Pan Head m5x16	MP3516	1.99
Screw, Pan Head m5x20	MP3520	2.25
Screw, Pan Head m5x25	MP3525	2.35
Screw, Pan Head m5x30	MP3530	2.49

METRIC HARDWARE KITS & REPLACEMENT HARDWARE

- Kits feature grade 5 hardware with a zinc finish
 - Sold in an adjustable section box measuring 13.5" x 9.25"
- ALL KITS ARE 250 PIECES**



PART #	DESCRIPTION	
MP0100	Hardware Kit, Metric Nuts: An assortment of standard, nylock, flange, fuji lock and low dome acorn nuts	184.99
MP0300	Hardware Kit, Flange Head Bolts: An assortment of 6mm flange head bolts from 6x10 through 6x45 and 8mm flange head bolts from 8x16 through 8x50 (all in 5mm increments)	66.99
MP0500	Hardware Kit, Pan Head Screws: Assortment of 5mm pan head screws from 5x10 through 5x30 (in 5mm increments) 6mm pan head screws including 6x8, 6x12, 6x16, 6x18, then 6x20 through 6x60 (in 5mm increments)	116.99
MP1100	Hardware Kit, Off-road: All essential fasteners for an off-road mechanic's shop	61.99



TOOL PACK HARDWARE KIT CARD OF 12 PACKS

- Display holds 12 hardware kits
- Kits have 22 pieces that contain nuts, bolts, and washers most commonly needed for Off-Road/MX repairs
- Designed for modern off-road, MX and Dual Sport motorcycles
- Developed to carry in your T6 Tool Pack for trail side repairs, but equally as useful in your toolbox

MP1200 84.99



MOTION PRO 54 PIECE EURO BOLT KIT

- 52 Piece assortment of the most popular KTM/Husqvarna style replacement hardware
- Metric class (grade) 8.8 for outstanding wear and durability
- Durable zinc plated finish for ultimate corrosion protection
- Perfect size to carry in your tool box or saddle bag

144376 24.99



- 2x M6 Euro Style Convex Washers
- 2x M6x16mm Fender Washer
- 1x M8 1.25 Flange Nut
- 1x M6 1.0 Flange Nut
- 2x M5x10 Pan Head Screw
- 3x Brembo Style Brake Pin Clip

Kit contains the following items:

- 4x M6x20 Euro Style Shroud Screw
- 4x M6x12 Euro Style Fork Guard Bolt
- 4x M6x12 Euro Style Torx Hex Head Flange Bolts
- 4x M6x16 Euro Style Torx Hex Head Flange Bolts
- 4x M6x20 Euro Style Torx Hex Head Flange Bolts
- 4x M6x30 Euro Style Torx Hex Head Flange Bolts
- 6x M6x12 Euro Style Torx Hex Head Large Flange Bolts
- 6x M6x20 Euro Style Torx Hex Head Large Flange Bolts
- 3x M5x12 Euro Style Hex Head Flange Bolt
- 4x M8x30 Euro Style 10mm Hex Head Flange Bolts

- tires & wheels
- axles, hubs & springs
- tongue accessories
- hitches
- electrical
- brake parts
- trailer hardware
- locks & pins
- towing & loading
- tie downs
- tools
- chemicals

STEPLESS CLAMP FUEL LINE FITTINGS KIT

- Convenient kit includes 70 pcs of hardware, a Motion Pro Side Jaw Pincer tool, and a convenient fuel line clamp size chart
- Kit includes following items packed in a convenient storage box:

142612	Stepless Clamps, 7.8mm to 9.5mm range	10 pcs
143502	Stepless Clamps, 9.6mm to 11.3mm range	10 pcs
142613	Stepless Clamps, 10.3mm to 12.8mm range	10 pcs
142614	Stepless Clamps, 10.8mm to 13.3mm range	10 pcs
142615	Stepless Clamps, 12.0mm to 14.5mm range	10 pcs
143503	Stepless Clamps, 13.2mm to 15.7mm range	10 pcs
142616	Stepless Clamps, 14.8mm to 18.0mm range	10 pcs
12-0073	Side Jaw Pincer Tool	



143504 184.99

FUEL HOSE CLIP



SIZE	PART #	
5/16" clips (for 3/16" hose)	670025	12.99
7/16" clips (for 1/4" hose)	670026	12.99
1/2" clips (for 5/16" hose)	670027	12.99

26-PC KEY TYPE HOSE CLAMPS

- Key type hose clamps, no tools needed
- Sizes include: 1/2", 5/8", 3/4", 7/8" and 1"
- Handy storage case keeps sizes organized
- Large easy to turn keys tighten securely



260143 13.95



FAST SAME DAY SHIPPING

TRAILER

TOOLS

12PC RAIL HOOK SET

- This set contains 4 each of the J, L and double loop hooks
- Small hooks provide flexible storage solutions to help organize your work area
- Hooks mount easily onto our bin rail set **260136** or with any of the rails that come with the Dual Position Tilt Bin line
- Easily moved anywhere along your bin rail for maximum flexibility
- Kit



260135	32.95
---------------	--------------

32 INCH BIN RAIL SET 2 PACK

- Add on rails can be used with both Dual Position Tilt Bins and standard Performance bins to expand your storage system
- Holes are predrilled at 16" intervals for mounting to wall studs or standard peg board holes
- Rails are 3.5" tall and 31.75" long
- 2 rails included



260136	13.95
---------------	--------------

BINS

- Clear Bin feature lets you easily see what's in each bin
- When used with accessory rails the Dual Position Tilt Bin feature allows better access to your parts 30% thicker walled than standard bins for strength and durability
- Stack vertically without use of rack or align horizontally
- Clear dividers are available so you can maximize your storage options
- Great for organizing home, office or workshop



6 PIECE	260137	12.95
DUAL POSITION TILT BINS SMALL		

4.125" w x 3.125" t x 7.5" d
4lb. Capacity

4 PIECE	260138	15.95
DUAL POSITION TILT BINS MEDIUM		

5.81" w x 4.875" t x 9.125" d
6lb. Capacity

3 PIECE	260139	21.95
CLEAR BINS LARGE		

7.25" w x 6.81" t x 11" d
8lb. Capacity

CLEAR PLASTIC BIN DIVIDERS

Use these clear plastic dividers with the Dual Position Tilt Bins and Clear Bins (above) to divide bins in half to make the most of your storage options



6 PIECE	260140	3.95
DIVIDERS SMALL		

Use with Item 260137

4 PIECE	260141	4.95
DIVIDERS MEDIUM		

Use with Item 260138

3 PIECE	260142	5.95
DIVIDERS LARGE		

Use with Item 260139

TRAILER

NEW



NEW

RISK RACING UTILITY JUG



- 3 gallon (12 liter) or 5 gallon (20 liter)
- Durable thick-walled HDPE plastic
- 3 ergonomic handle design
- Unique breather allows adjustable venting,
- prevents leaks/spills and won't fall out or get lost
- Flat surface in center of jug for custom graphics
- Transport safely and securely with the EZ Floor Mount
- Recommended with our "Hose Bender" spout

DESCRIPTION	U/M	ITEM#	
EZ5 UTILITY JUG	EA	989330	49.99
EZ3 UTILITY JUG	EA	989331	39.99

RISK RACING UTILITY JUG FLOOR MOUNT



- Easily secure the EZ3 or EZ5 Utility Jug to your truck, trailer or van
- Ability to use a padlock for extra security
- Size: 11" x 6.75" x 3.5" (27.5cm x 14.5cm x 8.9cm)
- Use with EZ3 or EZ5 Utility Jug
- Recommended flathead screw size (not included): (Pick the appropriate screw according to your mounting application)
- - 5x Wood or sheet metal flathead screws: #8 - 1" length
- - 5x Flathead bolts: 3/16"

DESCRIPTION	U/M	ITEM#	
EZ UNIVERSAL TRANSPORT MOUNT	EA	989332	24.99

RISK RACING HOSE BENDER

- Spout bender for spill free operation
- Stability hook
- High efficiency flow rate
- Threads into most caps



DESCRIPTION	U/M	ITEM#	
HOSE BENDER - PREMIUM UTILITY JUG SPOUT	EA	989333	19.99

RISK RACING MAGNETIC LIGHT MINE

- Bright wide angle LED
- 12 rare earth magnets for easy handsfree operation
- Small to fit in tight spaces (about the size of a golf ball)



DESCRIPTION	U/M	ITEM#	
MAGNETIC LIGHT MINE - TASK LIGHT	EA	989334	7.99

RISK RACING MAGNETIC LIGHT MINE PROFESSIONAL FLASHLIGHT



- 250 lumen Bright white LED
- Rear red night vision/hazard light
- 12 Neodymium magnets to aim light at many angles
- Use as a pick up tool
- 4 mode button switch
- Weather resistant

DESCRIPTION	U/M	ITEM#	
LIGHT MINE PROFESSIONAL - TASK LIGHT	EA	989335	24.99

RISK RACING FLEXIT 2.0 FLASHLIGHT



- Ultra-thin flexible silicone body
- 16 bright Lumen Tech LEDs
- 4 Light Functions (low, medium, high, flashing)
- Long operation time with (3) AA batteries - included
- 2 rare earth magnets for easy hands-free operation

DESCRIPTION	U/M	ITEM#	
RISK RACING FLEXIT 2.0 FLASHLIGHT - 200 LUMENS	EA	989336	29.99

- tires & wheels
- axles, hubs & springs
- tongue accessories
- hitches
- electrical
- brake parts
- trailer hardware
- locks & pins
- towing & loading
- tie downs
- tools
- chemicals

TRAILER

NEW

RISK

NEW

RISK RACING FLEXIT HEADLAMP



- 250 True Lumens
- Center CREE LED spot light
- Comfort fit foam
- Fully flexible body
- 5 light modes
- Weather resistant

DESCRIPTION	U/M	ITEM#
FLEXIT HEADLAMP - 250 LUMENS	EA	989337 39.99

RISK RACING FLEXIBLE MAGNETIC FLASHLIGHT



- 500 lumens
- Center CREE LED spot light
- Dual charging via solar panel or micro-USB
- Red night reading LEDs
- Fully flexible body
- Non-marring rubber magnetic durable base
- Shape-Loc frame
- 5 light modes
- Weather resistant

DESCRIPTION	U/M	ITEM#
FLEXIT SOLAR FLEXIBLE FLASHLIGHT 500 LUMENS/SPOT	EA	989338 49.99

RISK RACING MOTION ACTIVATED LIGHTING SYSTEM



The MPI creates five points of light, all from your existing fixture! These 5 points spread light to all corners of the room.

989339 199.99

DESCRIPTION	U/M
MPI - MULTI POINT MOTION ACTIVATED LIGHTING SYSTEM	EA

RISK RACING TRILIGHT CEILING LIGHT

The TRiLIGHT motion sensing LED ceiling light replaces the dim light bulb typically found in your garage, basement or utility room. Upgrading to 4000 TrueLumens Bright White LED light and motion activation is as easy as screwing in a light bulb! Now with adjustable motion sensitivity!



DESCRIPTION	U/M	ITEM#
TRILIGHT MOTION ACTIVATED CEILING LIGHT	EA	989340 69.99

RISK RACING TRILIGHT SHOPLIGHTV2

The TRiLIGHT ShopLight V2 has the ability to quickly transform from a 360 degree drop light, into a single direction shop light, and any light pattern in-between.

989343 49.99



DESCRIPTION	U/M
RISK RACING TRILIGHT SHOPLIGHTV2	EA

RISK RACING TRILIGHT SHOPLIGHT

The TRiLIGHT ShopLight quickly transforms from a 360 degree 3000 TrueLumen drop light, into an omni-directional shop light, and any light pattern in-between. This adaptability offers a wider variety of more useful light arrays in comparison to traditional shop lighting.



DESCRIPTION	U/M	ITEM#
TRILIGHT SHOPLIGHT	EA	989341 129.99

RISK RACING MOBILE TASK LIGHT

- 1200 lumens
- Dual focus lens
- Dual Lithium-ion battery technology
- Micro-USB Rechargeable
- 4 light modes (high, medium, low, strobe)
- Battery level indication, via button when The Mobile Task Light is turned off
- Adjustable Aluminum Head
- Steel ExoSkeleton
- Hanging Hooks
- Universal camera tripod mount



DESCRIPTION	U/M	ITEM#
MOBILE TASK LIGHT - RECHARGEABLE - 1200 LUMENS	EA	989342 59.99

- tires & wheels
- axles, hubs & springs
- tongue accessories
- hitches
- electrical
- brake parts
- trailer hardware
- locks & pins
- towing & loading
- tie downs
- tools
- chemicals

TRAILER

5 GALLON PORTABLE AIR TANK

W/COLOR DISPLAY BOX

- 125 PSI Maximum
- Light-Weight, portable with handle for easy transport
- Safety pressure bypass valve with manual override
- On/Off air adjustment dial
- Industrial grade air hose with standard tire air chuck
- Hi-Viz color for added visibility



W10005 102.95

11 GALLON PORTABLE AIR TANK

W/COLOR DISPLAY BOX

- 125 PSI Maximum
- Light-Weight, portable with handle for easy transport
- Safety pressure bypass valve with manual override
- On/Off air adjustment dial
- Industrial grade air hose with standard tire air chuck
- Hi-Viz color for added visibility



W10011 144.95

2 TON JACK STANDS (1 PAIR)

- Ratchet style for easy adjustments
- 10-3/8" to 16-3/8" range



260086 57.95

2 TON HYDRAULIC BOTTLE JACK

- Heavy duty base.
- Adjustable top screws.



260074 29.95

2.5 TON JACK

- 5 to 15-1/2" lift range.
- Swivel casters for easy positioning.
- Durable flanged steel frame.
- Great for cars and light duty trucks.



260075 130.95

MULTI-PURPOSE LIFT

- 1,500 lb capacity
- Lift range 4-1/2" to 16-1/2"
- Tow safety bolts ensure stability
- Three position locking levers
- Non-slip rubber foot pedal
- Easy to roll steel swivel casters



W41035 368.95

- tires & wheels
- axles, hubs & springs
- tongue accessories
- hitches
- electrical
- brake parts
- trailer hardware
- locks & pins
- towing & loading
- tie downs
- tools
- chemicals

TRAILER

FAST SAME DAY SHIPPING

- tires & wheels
- axles, hubs & springs
- tongue accessories
- hitches
- electrical
- brake parts
- trailer hardware
- locks & pins
- towing & loading
- tie downs
- tools
- chemicals

TRAILER

SWIVEL SEAT BAR STOOL

- 30" high with 14" round padded seat that swivels 360°
- Durable vinyl covering
- Chrome plated tubular steel legs
- Non-slip rubber feet for stability



Great for your garage, game room, etc.



W85010 91.95

ROLLING WORK SEAT

- Lightweight and durable composite seat with 4 swivel casters
- Storage trays and built-in storage compartment
- Great for working around wheels and brakes
- Size: 18" x 13.4" x 12.4"
- Weight capacity 330lb



260162 32.95

BOOT AND SHOE BRUSH

- Wood blocks with heavy duty steel frame easily screwed down to any surface using the integrated tabs
- Heavy poly bristles for long life



260149 18.95

PLASTIC BOOT TRAY

- Perfect for muddy and wet boots and shoes
- Large enough to hold 3 pairs
- Made of 100% recycled materials



260164 7.95

ROLL - AROUND STOOL

- Pneumatic action adjusts seat to 20" height quickly & easily
- Convenient 15" diameter tool tray
- Shielded 2-1/2" casters
- Fully padded 12" diameter seat



W85008 93.95

40" PLASTIC CREEPER W/6 CASTERS

- 40" molded plastic creeper
- 6 casters pivot 360°
- Lightweight - 10.5 lbs.



260090 87.95

2 TON POWER PULLER

- 2 ton pull capacity (rolling)
- Automatic notch at a time release for maximum safety
- 12 foot cable

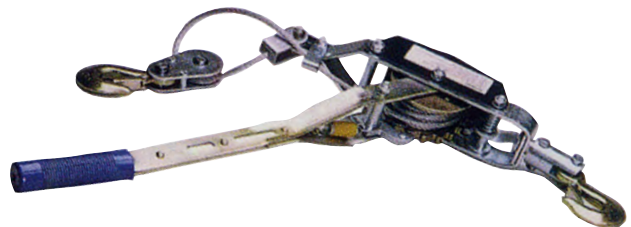

W4000 54.95

12" TOOL BAG

- 3 Pockets for easy organization
- Tough 600 denier fabric construction
- Reinforced bottom for added strength
- Heavy duty stitching and bar tacking at stress points
- Wide zipper opening for easy access



260163 13.95

12" CHROME PROTECTOR

- Fits 1" to 2" webbing
- 100% polyester/simulated sheepskin
- 1 pack

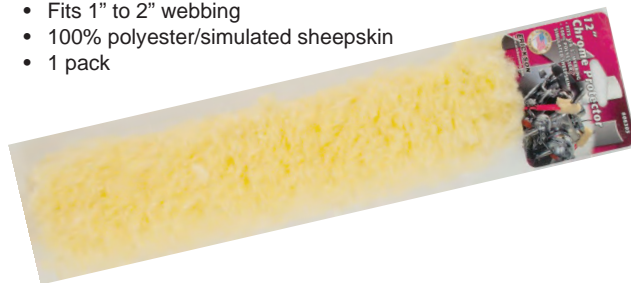

PART #	MFG #	U/M	
266044	06305	EA	6.95



ALUMINUM POLISHING KIT

- This polishing kit is designed to be used for harder finishes like Aluminum, brass, and copper Includes 4-oz black (first stage), brown (second stage) and white (final polish) emery polishing compounds
- Polishing pads include: 3" mushroom and 2-1/2" tapered cylinder
- Polishing felts include: 3-1/5" bullet, 2-1/5" conical, 2-3/10" cone and 2-3/10" pear
- Polishing wheels include: 2", 3" and 4"
- All have 1/4" round shaft for use with power drill
- The three wheels share one shaft

260155 36.95



STAINLESS POLISHING KIT

- This polishing kit is designed to be used for harder finishes like Chrome, Stainless steel and iron
- Includes 4-oz. black (first stage), brown (second stage) and white (final polish) emery polishing compounds
- Polishing pads include: 3" mushroom and 2-1/2" tapered cylinder
- Polishing felts include: 3-1/5" bullet, 2-1/5" conical, 2-3/10" cone and 2-3/10" pear
- Polishing wheels include: 2", 3" and 4"
- All have 1/4" round shaft for use with power drill
- The three wheels share one shaft Includes 4-oz. white (first stage), and red (final polish) emery polishing compounds

260156 35.95



16GA EXTENSION CORD

- Vinyl covering protects against moisture, abrasion, and direct sunlight and is suitable indoor/outdoor use
- Three-prong plug, grounded for safety
- High visibility orange, with single outlet
- 13 Amp max rating



25 Foot	260121	32.95
50 Foot	260122	59.95



120V 25FT METAL DROP LIGHT

- Reflective galvanized metal lamp shield with hang hook Impact resistant handle with durable push on/off switch
- Uses up to 75 watt incandescent bulb
- 25ft 18GA cord
- Display packaged
- Sold each



260120 34.95

- tires & wheels
- axles, hubs & springs
- tongue accessories
- hitches
- electrical
- brake parts
- trailer hardware
- locks & pins
- towing & loading
- tie downs
- tools
- chemicals

TRAILER

- tires & wheels
- axles, hubs & springs
- tongue accessories
- hitches
- electrical
- brake parts
- trailer hardware
- locks & pins
- towing & loading
- tie downs
- tools
- chemicals

120V PORTABLE LED WORK LIGHT

- Ultra high output of more than 1000 lumens LED technology means unit stays cool enough to touch
- Wide angle LEDs distribute large flood beam of light
- 16 in 18GA power cable
- Foam covered S-handle
- On/off switch
- Specs: 1030 lumens, Beam distance 65m, Max cd 1050



260124 50.95

LED WORKLIGHT

- 24 super bright white LEDs
- Convenient built in hook
- Strong magnet attaches to almost any metal surface
- Swivel hook adjust to multiple angles and stores away easily
- Includes (3) AA batteries



W2424 12.95

CAMO LED WORKLIGHT

- Dual Mode High Output LEDs works on low (1 LED) or high (2 LEDs)
- Rare earth magnet on back for hands free work
- 360° swivel hook for added versatility
- 92 Lumens, 3.5hr run time, 13m beam
- Uses 3 AAA batteries (included)
- Display packaged



260125 9.60

1M CP SPOTLIGHT - BLACK

- High power quartz halogen bulb
- Lockable trigger switch for hands free use
- Comfort grip with built in hanging hook and tripod hole
- Includes both a car charger and household charger
- LED charge indicator light
- Great for roadside emergencies, power failures, camping, boating, home, auto and more



260078 28.95

POCKET LED FLASHLIGHT

- Black essential LED flashlight
- Super Bright Nichia LED never needs replacing
- Anodized aluminum housing
- 55 lumens, 3.5 hour run time, 100m beam



W2450 4.95



SUPER BRIGHT 9 BULB LED POCKET FLASHLIGHT

- 3 1/2" tall
- Super Bright Nichia LED never needs replacing
- Aluminum housing with camo pattern
- 55 lumens
- 3.5 hour run time
- 100m beam



Buy 16 and get a free display



W2452 5.95

ALUMINUM LED FLASHLIGHT

- Super Bright Nichia LED never needs replacing
- Anodized aluminum housing
- 55 lumens, 3.5 hour run time, 100m beam
- Single LED Flashlight

(Our Choice of Color)



W2451 4.95

TRAILER

FIREPOINT 43LM 3-IN-1 UV

- Features high output flashlight, UV light and laser pointer
- Super Bright Nichia LEDs never need replacing
- Anodized tactical aluminum housing
- UV light great for fluid and glass leak detection, ID and document verification, currency detection and more
- Specs: 43 lumens, 7.5 hour run time, 41m beam distance, 440cd peak beam intensity



260126 11.95

3AAA LED PENLIGHT

- Super Bright Nichia LED never needs replacing
- Anodized aluminum housing with pocket clip
- Compact design fits anywhere
- Requires 3AAA batteries (included)
- Specs: 72 Lumens, 4.5 hour run time, 1333cd beam intensity, 73m beam distance



260123 9.60

FIREPOINT 294LM DUOFOCUS

- Adjustable DuoFocus beam goes from spot to flood
- Super Bright Nichia LED never needs replacing
- Anodized tactical aluminum flashlight
- Water and impact resistant
- Specs: 294 lumens, 4 hr runtime, 129m beam
- Batteries included



260130 18.95

2-PACK 55 LUMEN LED FLASHLIGHT

- 2 pack essential LED flashlights
- Super Bright Nichia LEDs never need replacing
- Anodized aluminum housing
- 55 lumens
- 3.5 hour run time
- 100m beam



W2459 10.95

FIREPOINT 1000LM DUOFOCUS

- Produces over 1000 lumens
- Comparable to a 100 Watt lightbulb
- Adjustable DuoFocus beam goes from spot to flood
- Super Bright Cree LED never needs replacing
- Anodized tactical aluminum housing
- Water and impact resistant 1068 lumens on high, 209 lumens on low, 13hr runtime, 346m beam
- 9AA Batteries included



260132 37.95

FIREPOINT 330LM RECHARGEABLE

- RECHARGEABLE LITHIUM ION BATTERY - Includes 12V & 120V Chargers
- Super Bright Nichia® LED never needs replacing Interchangeable snap on lenses
- Padded nylon belt pouch
- Specs: 330 Lumens (HIGH), 95 Lumens (LOW), 2 Hr 30 min run time (HIGH), 200M beam Distance, 9000 MCD



260129 59.95

2 IN 1 LED LIGHT & LASER

- Flexible head super bright LED light
- Red laser pointer
- Pocket clip
- Magnetic base
- 3 bonus LR44 Batteries (6 batteries total)



W2380 7.95



2 in 1 Light & Laser (Our Choice of Color)

- tires & wheels
- axles, hubs & springs
- tongue accessories
- hitches
- electrical
- brake parts
- trailer hardware
- locks & pins
- towing & loading
- tie downs
- tools
- chemicals

TRAILER

ERICKSON TARPS

POLYETHYLENE RIP-STOP TARPS

- 5 oz. polyethelene
- Bright blue
- 8 X 8 weave
- Grommets every 3 ft.
- Waterproof
- Tear proof

CUT SIZE	PART #	
5 X 7	BPT57	1.95
8 X 10	BPT810	4.40
8 X 15	BPT815	6.60
10 X 12	BPT1012	6.55
10 X 18	BPT1018	9.90
12 X 12	BPT1212	7.90
12 X 25	BPT1225	16.45
15 X 30	BPT1530	24.70
16 X 20	BPT1620	17.55
20 X 30	BPT2030	32.95
20 X 40	BPT2040	43.95



BROWN/GREEN REVERSIBLE TARP

- 10X10 Weave
- Reversible:
Brown on one side/
Green on the other
- Blends in with spring and
fall colors
- Features strong plastic
reinforced corners for
added strength

CUT SIZE	PART #	
6 X 8	EK57030	10.95
8 X 10	EK57031	16.95
10 X 12	EK57032	23.95
12 X 16	EK57033	36.95
12 X 20	EK57034	45.95
16 X 20	EK57035	59.95
18 X 24	EK57036	81.95



HEAVY DUTY MESH TARP

The mesh design allows the air to flow through and works great for covering loads that need containment but not water repellency. The flapping we see with most tarps is drastically reduced with the mesh design.

Ideal for:

- Trailer covers
- Dump truck covers

CUT SIZE	PART #	
6 X 8	EK57056	46.95
8 X 10	EK57057	65.95
10 X 12	EK57058	90.95
12 X 16	EK57059	133.95



HEAVY DUTY CAMO TARP

- 10 x 10 weave with
reinforced corners
- Increased UV content for
longer life
- Rust resistant grommets
- Lightweight and flexible
easy storage

CUT SIZE	PART #	
10 X 12	EK57005	38.95

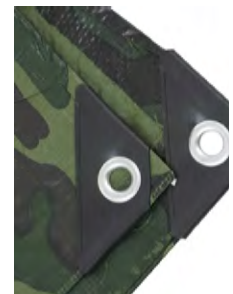

35 PC TIRE HARDWARE KIT

- 4 pcs chrome hex valve caps
- 4 pcs high temp valve cores
- 4 pcs plastic valve stems
- 1 pc 4 way valve tool
- 1 pc tire pressure gauge
- 1 pc rubber cement tube
- 1 pc metal scuffer
- 10 pcs round patches
- 3 pcs tubeless tire repair plugs
- 1 pc reamer
- 1 pc plugger

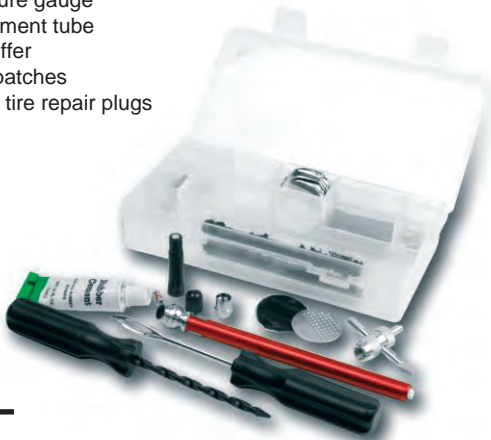

260001 15.95

TIRE REPAIR & MAINTENANCE KIT

- 8 pcs chrome hex valve caps
- 8 pcs high temp valve cores
- 2 pcs each long rubber tire valves and short rubber tire valves
- 8 pcs each plastic valve caps and plastic valve extensions.
- 1 pc each valve core remover, tire chuck and dual foot tire pressure gauge
- 20 pcs tubeless tire repair plugs
- 1 pc each ergonomic grip reamer and ergonomic grip plugger
- For patching, 1 tube rubber cement, 1pc metal scuffer, 2pcs rectangular patches, 2 pcs large round patches and 15pcs small round patches



260000 39.95

tires & wheels

axles, hubs & springs

tongue accessories

hitches

electrical

brake parts

trailer hardware

locks & pins

towing & loading

tie downs

tools

chemicals

5 PACK TUBELESS TIRE REPAIR PLUGS

4" long tire repair plugs



260004 3.95

30 PACK TUBELESS TIRE REPAIR PLUGS

4" long tire repair plugs



260003 6.95

RUBBER CEMENT

- For use with tire patches
- Many uses around the house and garage



260005 6.95

BRONCO TIRE INFLATOR KIT

- CO2 Tire repair kit which includes five 4" tire seals, two tire repair tools, a regulator and three 16g CO2 cartridges
- Includes bag with Bronco logo
- Display packaged



62-12058 26.95



4 WAY FOLDING LUG WRENCH

- SAE heavy duty drop forged steel
- Chrome plated to resist corrosion
- SAE and metric sizes: 11/16", 3/4", 13/16" and 7/8", 17mm, 19mm, 21mm and 23mm
- Folds down for compact storage



260089 30.95



TRAILER

- tires & wheels
- axles, hubs & springs
- tongue accessories
- hitches
- electrical
- brake parts
- trailer hardware
- locks & pins
- towing & loading
- tie downs
- tools
- chemicals

ADJUSTABLE TARP STRAP

24" long • 6 per package

Adjustable tarp straps have heavy reinforced holes every 6" along the strap to hook back into or move the end hook to make it shorter.



ERICKSON

EK6724 18.95 pkg

BLACK RUBBER TARP STRAPS

These rubber bungee cords are a versatile tie down strap and are easily stored. These rubber straps have a 2" S-Hook on each end.



Package of 10 Includes:

- (4) - 9"
- (2) - 15"
- (2) - 21"
- (2) - 31"

ERICKSON

EK06610 20.95 pkg

BLACK RUBBER TIE DOWNS

- Quick and easy, just hook and secure into place
- Extra heavy duty 3/4" flat rubber tie downs with heavy reinforced ends and heavy 2-1/2" steel hooks
- Maximum resistance to all weather conditions

ERICKSON



LP13910	1.39	10"
LP13915	1.69	15"
LP13921	2.19	21"
LP13931	2.79	31"
LP13941	2.99	41"

FLAT BUNGEE CORDS

- A hardened metal wire form is placed in the center of the moulded polycarbonate hook - making it super strong
- Sold each

ERICKSON

12"	EK06912	3.95
18"	EK06918	6.95
24"	EK06924	6.95
30"	EK06930	6.95
36"	EK06936	6.95
42"	EK06942	7.95

DELUXE BUNGEE CORDS

- Talk about quality! That's what the deluxe bungee is all about
- An Industrial grade bungee comes secured to a moulded polycarbonate hook with a hardened wire insert moulded in
- 3 sizes available in 3 colors

ERICKSON

12", Red	EK07012	2.95
24", Blue	EK07024	6.95
36", Yellow	EK07036	6.95



E-TRACK ADJUSTABLE TIRE STRAP

- For standard tires
- Sold each
- Yellow

ERICKSON



EK08314 58.95 ea

ADJUSTABLE TIRE STRAP W/RATCHET

- 10,000 maximum load capacity
- Short swivel j-hook adds ease when operating in tight corners
- Adjustable tire strap, 1 pack
- Yellow



ERICKSON

EK08522 63.95 ea

10,000# ADJUSTABLE TIRE STRAP W/RATCHET



ERICKSON

EK58522 55.95 ea

TRAILER

HANDYMAN FIRST AID KIT

- This kit combines the first aid essentials needed in the event of a minor injury in your work area
- Compact zipper case with handy carabiner clip
- 5 pieces fabric bandages - 3 in. x 1 in. (7.5 cm x 2.5 cm)
- 4 pieces fabric knuckle bandages
- 4 pieces fabric fingertip bandages
- 0.5 oz (15 ml) saline solution
- 1 piece non-woven triangular bandage
- 2 pieces small dressing
- 1 piece finger dressing
- 6 pieces safety pins
- 2 pieces alcohol wipes
- Display packaged
- Sold each



260118 12.95



PERFORMANCE TECH WEAR MECHANIC GLOVES

- Protects hands from cuts, scrapes and burns
- Comfortable and durable
- Thick enough to protect and thin enough to handle small objects
- Soft, flexible fabric is breathable and easy to clean



Small	W88998	20.95
Medium	W88999	20.95
Large	W89000	20.95
X-Large	W89001	20.95



G1 SAFETY GLASSES

No-frills safety glasses, meant to keep cost low - with all the quality you expect from RZ®.



COLOR	PART #	
RZ Adjustable G1 Safety Glasses - CLEAR LENSES	650931	11.95
RZ Adjustable G1 Safety Glasses - TINTED LENSES	650932	11.95



G2 SAFETY GLASSES

Premium safety glass, with an upgraded nose bridge and adjustable-length ear pieces.



COLOR	PART #	
RZ Adjustable G2 Safety Glasses - CLEAR LENSES	650933	17.95
RZ Adjustable G2 Safety Glasses - TINTED LENSES	650934	17.95

RANGER POLYCARBONATE FRAME/LENS



- Functional safety glasses never go out of style
- Complete protection at a very economical price
- The design incorporates side shields and brow protection
- Lens made from uncoated Polycarbonate. and it provides excellent impact resistance, as well as 99.9% UV protection
- Amber lens improves contrast at dusk or in overcast conditions
- Fits over many prescription glasses

Clear	EV10C	2.70
-------	-------	------



FAST SAME DAY SHIPPING

tires & wheels
axles, hubs & springs
tongue accessories
hitches
electrical
brake parts
trailer hardware
locks & pins
towing & loading
tie downs
tools
chemicals

TRAILER

- tires & wheels
- axles, hubs & springs
- tongue accessories
- hitches
- electrical
- brake parts
- trailer hardware
- locks & pins
- towing & loading
- tie downs
- tools
- chemicals

TRAILER

GO-SPECS™ LIGHTWEIGHT LIKE SAFETY GLASSES, SEALING LIKE GOGGLES



Elvex Go-Specs™ primary objective is to provide an extra measure of protection in dusty and dirty environments. Wind blown particles such as dust, sand, cement, chemicals can cause serious eye irritation and damage. In addition to this specialized task, Go-Specs offers a full range of features and benefits:

- Impact resistant molded lens with SuperCoat™ anti-fog coating
- 1.8 mm thick Polycarbonate lens with a base 6 curvature
- Polyurethane foam seal
- Angle adjustable temples
- 99% UV protection for UV A, B and C, 180-380 nm
- Tested to ANSI Z87 (+)
- High velocity impact resistant



Clear Anti-Fog	EV401	9.02
Gray Anti-Fog	EV402	9.08

XENON ULTRA LIGHTWEIGHT DESIGN FOR COMFORT & STYLE

- Elvex Xenon safety glasses represent our most lightweight design. They are so lightweight that it is easy to forget that you have them on.
- Xenon fits smaller faces and female faces very well.
- Comfortable and stylish design
- In addition to its good looks Xenon offers a soft rubber nose bridge and colorful rubber inserts on the temples.
- Tested to ANSI Z87.1-2003 (Z87+), and to CE EN-166.



Clear	EV141	2.62
Clear Anti-Fog	EV142	3.55
Blue	EV143	2.84
Indoor/Outdoor	EV144	3.45
Gray	EV145	2.84
Gray Anti-Fog	EV146	3.55
Mirror	EV147	3.45

ELITE FOR THE STYLE CONSCIOUS



Styling aside, this frame offers a soft rubber nose bridge as well as rubber tipped temples. Complies to ANSI Z87.1-2003 (Z87+).

Gray Lens w/Black & Yellow Frame	EV2003	5.50
----------------------------------	--------	------



TRIX HIGH STYLE COMBINED WITH LOW COST

Trix safety glasses provide style and comfort at a very affordable price.

- Available in the following lenses: clear, clear anti-fog, gray, indoor/outdoor and silver mirror
- All lenses provide 99% UV protection
- Universal length temples
- Complies with ANSI Z87.1-2003 (Z87+) and CE-EN-166



Clear	EV171	3.34
Clear Anti-Fog	EV172	4.46
NCB Gray	EV173	3.65

MAXIMUFF HIGH PERFORMANCE, ECONOMY EAR MUFF

- Super Seal ear cushions for long term comfort
- A soft cushioned headband
- Self-aligning suspension, and easy adjustment
- 28 dB NRR, 30 dB SNR



EV35	14.19
------	-------

VALUEMUFF COMFORT AND PROTECTION

- Soft and pliable Super Seal ear cushions
- Low headband force and light-weight, 6.8 oz.
- Easy adjustments with flexible slide clips
- Noise Reduction Rating down to 25 dB NRR - 28 dB SNR



EV25	9.46
------	------



AUTOMATIC
DISTRIBUTORS

TRAILER CATALOG

CHEMICALS

tires & wheels
axles, hubs & springs
tongue accessories
hitches
electrical
brake parts
trailer hardware
locks & pins
towing & loading
tie downs
tools

chemicals

TRAILER



PJ1 SUPER CLEANER

Multi-Application Non-Residue Degreaser

Attributes:

- High pressure blasts
- Powerful solvents melts grease and grime away
- Dries quickly
- Leaves no residue



DESCRIPTION	QTY/CS	PART #	MFG #	
13 oz	6	909041	3-21	11.85

PJ1 SPRAY & WASH

Aggressive Degreaser and Cleaner

Attributes:

- Rinses off with water
- Save on plastics
- Leaves no film or residue
- Has pleasant fragrance



DESCRIPTION	QTY/CS	PART #	MFG #	
13 oz	6	909043	15-20-1	13.90



PJ1 PROFESSIONAL CONTACT CLEANER

Professional Contact Cleaner

Attributes:

- Powerful Spray
- Removes Carbon and contaminants from plugs, points, and electrical components



DESCRIPTION	QTY/CS	PART #	MFG #	
13 oz	6	909048	40-3-1	11.85

PJ1 PROFESSIONAL BRAKE CLEANER

Professional Power Brake Cleaner

Attributes:

- Powerful spray
- Cleans and degreases contaminants from brake units
- Evaporates quickly and leaves no residue
- Improves braking performance



DESCRIPTION	QTY/CS	PART #	MFG #	
13 oz	6	909046	40-2-1	11.85



PJ1 RENEW AND PROTECT®

Non Oily Surface Treatment

Attributes:

- Unique, super silicone formula provides a penetrating moisturizer
- Restores original appearance
- Leaves satin not glossy finish
- For rubber, vinyl, plastic, wood and treated leather.



DESCRIPTION	QTY/CS	PART #	MFG #	
8 Fluid oz	12	909049	23-8	15.57
16 Fluid oz	12	909050	23-16	21.09



CONTACT CLEANER

Heavy duty citrus scented aerosol cleaner is a blend of special cleaning agents that remove grease, oil and other contaminants. Extra heavy propellant charge provides maximum spray pressure for hard to reach areas. Outstanding for use on all engine and suspension parts, carburetors, brakes, spark plugs and much more. Sold per can.



DESCRIPTION	QTY/CS	PART #	
13 oz Aerosol Can	12	930051	10.99



MPPL PENETRANT LUBE

Superior, all-purpose spray-on penetrating lubricant displaces moisture while providing excellent rust and corrosion protection. MPPL forms a protective film on metal and will not harm plastic or painted surfaces. Sold per can.



DESCRIPTION	QTY/CS	PART #	
20 oz Aerosol Can	12	930054	10.99



WATERPROOF GREASE

Multi-purpose grease has excellent resistance to water wash-out and it clings to metal surfaces under the most severe conditions. For use on motorcycle, ATV, personal watercraft and snowmobile components. Provides excellent protection against high loads, extreme temperatures, moisture, rust and corrosion. Sold per jar.



DESCRIPTION	QTY/CS	PART #	
16 oz Jar	12	930057	12.99

IMPORTANT NOTICE After installing Ride-On TPS Motorcycle Formula sealant into your tires you may notice a slight vibration until the sealant has warmed up and distributed evenly in your tires. This process usually takes 2 to 5 miles. Please DO NOT attempt to rebalance tires after the installation of Ride-On TPS Motorcycle Formula. Ride-On TPS is a balancing compound. Ride-On TPS will act as a balancer and will result in erroneous readings from a dynamic spin balancer that does not compensate for tire deflection, weight of the bike, brakes, or other suspension components. Ride-On is TPMS friendly, however it is not recommended for use in 2009, 2010, and 2012 Honda Gold Wings as their TPMS Sensors are not hermetically sealed.



RIDE-ON TPS TIRE BALANCER AND SEALANT



DESCRIPTION	PART #	
MOTORCYCLE FORMULA		
8 oz. (12 per case)	650274	19.00
12 oz. (12 per case)	650556	24.99
ATV/UTV FORMULA		
32 oz. (12 per case)	650275	21.92

BALANCE With one installation of Ride-On, lead weights become a thing of the past. While Ride-On works in conjunction with traditional weights, you won't need them anymore. Ride-On is specially formulated to hydrodynamically balance high-speed tires and dampen road noise and vibrations that cause a rough ride. The great thing is Ride-On will continue to adjust and literally rebalance your tires as you ride for the legal life of the tires. So go ahead, pop off those wheel weights, shine your wheels, and enjoy the smoothest ride you have ever experienced on your bike.

SAFETY FIRST With Ride-On TPS tire sealant, your tire literally fixes itself! If your tire is punctured, the centrifugal force of the rotating tire and the internal air pressure force Ride-On into the hole, sealing it virtually instantly. Since it helps eliminate porosity leaks that cause tires to deflate over time, your tires stay properly inflated, last longer, your bike handles better and gets more miles per gallon.

WORKS IN TUBE AND TUBELESS TIRES Ride-On TPS eliminates 85-95% of flats in tubeless tires from objects up to 1/4" (1/8" for tube tires) that penetrate the contact patch of the tire. Since puncturing objects often tear tubes, Ride-On's efficiency in tube tires is reduced to 55-65%. If the puncturing object remains in the tire, it is vital to remove it as soon as possible to prevent further injury to the tire or tube. Our company takes the position that any repair in a motorcycle tire should be treated as temporary.



- tires & wheels
- axles, hubs & springs
- tongue accessories
- hitches
- electrical
- brake parts
- trailer hardware
- locks & pins
- towing & loading
- tie downs
- tools

chemicals

TRAILER



RIDE-ON LED SMART CAPS

DESCRIPTION	PART #	
LED SMART CAPS		
LED Smart Cap Small Display w/Wired Cap	650278	33.95

The LED Smart Cap Tire Pressure Monitor (TPMS) valve cap is a must for people that want to make sure that their tires are properly inflated. Once installed the LED Smart Cap TPMS valve cap will alert you if the tire pressure drops by a setpoint pressure. The Light Vehicle version of the Smart Cap Tire Pressure Monitor system is available for automobiles, SUVs, light trucks, vans, motorcycles, scooters, trailers, ATVs, etc. with a pressure range of 10 to 70 psi and a low pressure warning trigger of 4 psi (with a +/- 10% accuracy).

- Easy to Install - Simply screw valve caps onto tire valve stems.
- Bright blinking LED light that is visible in daylight and night time
- Self-Calibrating - Automatically calibrates to pressure the tire was set at when the cap was installed. The same valve can be used with tires from 10 psi to 70 psi (Auto and Motorcycle Version with a 4 psi pressure drop alarm) or 30 to 170 psi for commercial version (available in 4 psi or 8 psi pressure drop alarm)
- Automatically compensates for ambient temperature changes to avoid false alarms.
- Comes with integrated anti-theft device.
- Long lasting low pressure alert - blinking red light alerts of low pressure for 750 hours (more than a month).
- Low battery alarm - the led valve cap will blink yellow for up to 100 hours to alert you that the batteries are running low.
- Long Lasting 3 year battery shelf life.
- Great compliment to Ride-On TPS filled tires - 100% compatible and now you can be alerted of a slow leak.
- Proper tire inflation pressure helps extend tire life.
- Proper tire inflation pressure helps optimize fuel economy and save up to 3% in fuel.
- Available in 2 and 4 pack blister Packaging, as well individual and bulk packaging.



FAST SAME DAY SHIPPING



HARDLINE PRODUCTS

RX UV PROTECTANT CLEANER AND POLISH

Rx UV Protectant Cleaner & Polish™ was specifically made for the Power Sports Industry and is quickly becoming the standard for protecting plastic and metal surfaces found on boats, motorcycles, PWC, ATV's, UTV's and all the accessories that go with them. Seals the surface with a micro-thin layer of UV protectant. Restores nutrients that sun, water and dirt take away. Just one use moisturizes and restores shine quickly and easily. Cleans and protects any plastic and metal. Just spray and wipe clean.

- Boaters use Rx on your Isinglass®, Strata Glass®, plastic, stainless steel, aluminum, gel-coat or any painted surface
- Vinyl windows will stay cleaner longer from water spots, salt spray and resist damaging UV rays from the sun
- Provides 100% UVA and UVB protection
- Cleans and protects from dirt, water spots, salt spray and grime
- Use on gauges, instruments, windscreens, bezels & trim to protect from the sun and add shine to your surfaces
- Its anti-static formula reduces salt and dirt buildup



DESCRIPTION	PART #	MFG #	
14 oz RX	315003	PLEX-RX	14.99



STICKER-ON!

Sticker On!™ takes the frustration away from decal applying. No more bubbled, misaligned, or wrinkled decals. Curvy application areas are easier to do. Works on any decal application, registration numbers, graphic kits, sponsorship decals, number plate backgrounds, racing numbers, OEM decals and much more. Simply spray it on the back of your decal and the application area, slide and position into place. Sticker-On!™ reactivates the adhesive in your decal when it cures. Environmentally friendly and comes in a convenient push pump 2 oz. recyclable bottle.

DESCRIPTION	PART #	MFG #	
2 oz bottle	HL964	964	5.99

STICKER-OFF!

Sticker-Off! takes the frustration away from decal removal. No more sticky residue left to mess up your new decals. Remove old decal adhesive easily. Works on any decal adhesive, registration numbers, sponsorship decals, number plate backgrounds, racing numbers, graphic kits, OEM decals and much more. Simply apply Sticker-off! onto adhesive residue, let it soften the residue for a minute and then wipe with a clean dry soft cloth. Sticker-off! is environmentally friendly and comes in a convenient push pump 2 oz. recyclable bottle.

DESCRIPTION	PART #	MFG #	
2 oz bottle	HL965	965	5.99



TREAD DOCTOR™

Tread Doctor Knobby Cutting Tool™ New Traction on Worn Tires!

Lightweight heated tool cuts new edges into your dull worn out knobby tires. Refresh your front or rear tire before installing a new one. Extends the life of your tire and gives you optimal tire performance throughout the life of your tires. Tread Doctor™ uses a specially designed heated carbide cutting blade to trim your knobby tires. This easy do it yourself tool gives you new traction for every ride! With a little practice you can cut the minimal amount of rubber off each time to get a new edge thus extending the life of your tires and giving you maximum traction for every ride.

- Get more traction for every ride with Tread Doctor!
- Now! Includes new cutting tip
- Use for Motocross, Trail, ATV/UTV, Enduro and Racing
- Use Tread Doctor™ to cut tires for different conditions
- Works on any brand of motorcycle tire
- Unit includes ON/Off Switch and holding stand
- Easily pays for itself with just one tire
- Get the most out of your tires even as they wear
- 100W 110V 50/60Hz
- Meets PSE requirements for Japan
- CE and ROHS certified
- Built to UL standards for design, construction and operation
- All components used exceed industry standard for durability and enhanced functionality

DESCRIPTION	PART #	MFG #	
Tread Doctor™	315001	TD-1	63.12





ACF-50 ULTIMATE CORROSION PROTECTION

ACF-50 ANTI CORROSION FORMULA Protects • Penetrates • Lubricates!

DESCRIPTION	SIZE	PART #	MFG #	
ACF-50 - Liquid	4 ltr / 1.06 Gal	650425	15004	119.95
ACF-50 - Aerosol	13 oz	650426	15013	15.75
ACF-50 - Liquid Spray Pump	32 oz	650427	15032	36.95
ACF-50 - Liquid	20 ltr / 5.28 Gal	650428	15020	500.95
Hand Held Spray System	includes 1 bullet tip / 3 wands	650429	50017	542.95

- Forms an "Active" ultra thin, clear film that kills existing corrosion cells, and will protect your quad or bike against new corrosion forming and last for 12 months.
- "ACTIVE" which means that it 'creeps' and 'keeps on working' DOESN'T NEED REAPPLYING AFTER EVERY WASH!
- Contains no water, silicon, teflon or wax - no sticky build up, no risk of existing corrosion being sealed in and no risk of water remaining where it will cause corrosion and damage, even on electronics
- Chemically neutralizes road salt
- A clean, clear ultra thin fluid
- Dries out moisture
- Safe on all components; electronics, chrome, paint and plastic
- Use on heads, cooling fans, throttle linkages, brake cables, battery terminals, voltage regulator, suspension, engine components, torsion bars, fuel control units, fuse box, swingarm, relays / connectors, undercarriage, chain, ignition switch, security systems / FOBs and more!
- ACF-50 can be sprayed on, wiped on with a rag, or professionally fogged for complete protection



Prevention is better than replacement!

Corrosion Block is a unique product that has the ability to both prevent and stop corrosion in more places on Powersports Equipment than any other product of its type.

Corrosion Block is superior anti-corrosion compound. It kills corrosion in progress, prevents new corrosion cells from forming for 12-18 months, is an excellent penetrant and is an excellent light lubricant.



CORROSION BLOCK AEROSOL

Kills Corrosion on Contact!

Protects metal and electronics during play and storage • Chemically neutralizes salt water • A clean, clear ultra-thin fluid which leaves a non greasy atmospheric barrier to protect all metal surfaces • Leaves no gummy residue because it does not contain wax, resin, tar, asphalt, silicone or Teflon • Can be sprayed, brushed or wiped on • Hydrophobic film provides corrosion protection all season • Protects metal components down to -70° • Keeps ice and mud from sticking • Combined with its excellent penetrating and strong dielectric properties (40Kv), have brought electronics "back from the dead" • Removes moisture from the corrosion by-product and isolates it from contacting the metal surface, restoring continuity to electrical circuits • Can be used in many different electrical and electronic applications without fear of damaging the conformal coatings used • Does not harm plastics or painted surfaces • Improves reliability, reduces repair and labor cost.

CORROSION BLOCK WATERPROOF GREASE

Out performs lithium and most synthetic greases and meets or exceeds requirements for NGLI Service Classifications GC-LB (automotive wheel bearing and chassis lubricants) conforming to ATM D4950 performance requirements • Excellent extreme pressure properties • Excellent thermal / oxidative stability • Resists bleeding / melting at high temperatures • Suitable for sealed for life applications • Dielectric / non-conductive • Workplace safe and environmentally friendly • Out performs competitive grease 5:1 • Waterproof.

DESCRIPTION	SIZE	PART #	MFG #	
Corrosion Block - Liquid	4 ltr / 1.06 Gal	650417	20004	114.95
Corrosion Block - Aerosol	12 oz	650418	20012	14.95
Corrosion Block - Liquid	32 oz	650419	20032	35.95
Corrosion Block - Liquid	20 liter / 5.28 Gal	650420	20020	438.95
Corrosion Block Grease	2 oz Tube	650421	25002	5.95
Corrosion Block Grease	3 oz Cartridge	650422	25003	10.95
Corrosion Block Grease	14 oz Cartridge	650423	25014	10.95
Corrosion Block Grease	16 oz Tub	650424	25016	11.95

- tires & wheels
- axles, hubs & springs
- tongue accessories
- hitches
- electrical
- brake parts
- trailer hardware
- locks & pins
- towing & loading
- tie downs
- tools
- chemicals

TRAILER

tires & wheels
axles, hubs & springs
tongue accessories
hitches
electrical
brake parts
trailer hardware
locks & pins
towing & loading
tie downs
tools
chemicals

TRAILER

ThreeBond

RTV SEALANT - GRAY

- RTV sealant (gray) high viscosity gasket maker.
- OEM specified product
- Good elasticity
- Temperature, chemical, oil, water, collant, and gasoline resistant
- Excellent as a general purpose LGM
- High resistance to heat and cold
- Sold each



DESCRIPTION	QTY/CS	PART #	MFG #	
3.8 oz	6	414000	TB1200GAU3Z	14.95

GASKET MAKER - GRAY

- High viscosity FIPG (form-in-place-gasket) gasket-maker
- OEM specified product
- Good adhesion properties in power-train and small engine applications
- Allows immediate service after application
- Non-slumping formulation 'holds-in-place'
- High resistance to engine and gear oil
- FIPG properties allow for greater 'gap' fill
- Sold each



DESCRIPTION	QTY/CS	PART #	MFG #	
5.3 oz	6	414001	TB1217H	20.95

GASKET MAKER - BLACK

- High performance
- High viscosity
- High temp resistance
- High adhesion.
- High torque endurance
- High vibration endurance
- Liquid gasket maker used on more than 5 Million engines
- Non-slumping paste
- Highly effective In continuous vibrating conditions
- Good adhesion to plastic
- Sold each



DESCRIPTION	QTY/CS	PART #	MFG #	
3.5 oz	12	414002	TB4207B	20.95

RTV SEALANT GRAY, LOW VISCOSITY, SOLVENTLESS

- High performance gasket maker
- Excellent heat/chemical and gear oil resistance
- Sold each



DESCRIPTION	QTY/CS	PART #	MFG #	
8.8 oz	6	414003	TB1215	31.95

SUPER GLUE

- ThreeBond Super Glue attains practical use strength in a matter of seconds
- Contains no evaporative elements, so there's never any shrinkage to weaken bonding points
- Excellent for non-porous materials
- Sold each



DESCRIPTION	QTY/CS	PART #	MFG #	
2 Grams	36	TB1720	1742BT020	6.95

LIQUID GASKET

- Excellent padding properties make this semi-drying, visco-elastic sealer the perfect product for sealing joint surfaces with large clearance
- Special synthetic rubber provides excellent cushion to absorb vibrations and impacts without failure, esp. where coolants are involved
- O.E. motorcycle manufacturers have successfully used this high reliability liquid gasket in numerous applications
- Comes in 3.5 oz. tubes
- Sold each



DESCRIPTION	QTY/CS	PART #	MFG #	
3.5 oz	24	TB1184	1194A100GA	12.95

SILICONE LIQUID GASKET

- ThreeBond 1211 Silicone Liquid Gasket is a tough durable sealer utilizing silicone rubber as a primary component
- White in color, its solventless, semi-drying and visco-elastic properties make it ideal for numerous applications where a long lasting, faultless seal is absolutely critical; as it comes in contact with air, it forms a rubberized, elastic mass impervious to vibrations and impacts
- Can be applied to flange surfaces and screw sections to prevent water, oil, gasoline and chemical leaks
- 100% effective over a wide temperature range - 76° to 482° F. Tack-free in 90 minutes; fully cured and bonded within 24 hours; attains optimum strength in three days
- Recommended for: motorcycle, personal watercraft, ATV engines
- Sold each



DESCRIPTION	QTY/CS	PART #	MFG #	
3.5 oz	6	TB1211	1211AT100	26.95

SYNTHETIC RUBBER ADHESIVE

- ThreeBond 1521 is a contact cement which is a multi-purpose, rubber based adhesive that gives excellent bonding characteristics to a wide variety of materials including rubber, plastic, vinyl, metal, leather, woods, ceramics and more
- Provides a strong, waterproof bond and sets up within 5-10 minutes depending on temperature and humidity
- Sold each



DESCRIPTION	QTY/CS	PART #	MFG #	
75 Grams	12	414004	7731521A75G	12.95

ThreeBond

GRIPLOCK

- A high adhesive specially formulated to keep grips in place without damaging the rubber
- Griplock puts an end to grips twisting or sliding off
- Ideal for motorcycle, personal watercraft, snowmobiles and ATVs
- Sold each



DESCRIPTION	QTY/CS	PART #	MFG #	
1 oz	12	TB1501	1501CT100	11.95
10 Grams	24	TB1505	1501CT102	7.95

HI STRENGTH RETAINING

ThreeBond's High strength retaining properties for various threads, screws, bolts, piping joints, gears, pulleys and fans which are not frequently removed or must remain secure for safety and/or structural integrity reasons. Sold each.



DESCRIPTION	QTY/CS	PART #	MFG #	
10 ml	6	TB1303	1303AT000	11.95
50 ml	12	TB2303	1303A50C	21.95

BEARING & STUD LOCK

ThreeBond's Bearing & Stud Lock includes high strength retaining properties for bearings and studs which are not frequently removed and must remain secure for safety or structural integrity reasons. Sold each.



DESCRIPTION	QTY/CS	PART #	MFG #	
10 ml	6	TB1333	1333BT001	11.95
50 ml	12	TB2333	1333B50C	21.95

LOW STRENGTH/ FREQUENT REPAIR

ThreeBond's Low Strength Frequent Repair product is perfect for small screws and bolts which are frequently removed and require a force of only 10-20% greater than that used for tightening. Sold each.



DESCRIPTION	QTY/CS	PART #	MFG #	
10 ml	6	TB1342	1342AT002	11.95
50 ml	12	TB2342	1342A50C	21.95

HI TEMPERATURE

ThreeBond's Hi Temperature Thread Lock is a new sealing and locking agent made to withstand extreme temperatures without weakening. Incorporates various strengths of anaerobic locking agents which makes it ideal for sealing engine and exhaust components. Sold each.



DESCRIPTION	QTY/CS	PART #	MFG #	
10 ml	6	TB1360	1360AT003	11.95
50 ml	12	TB2360	1360A50C	21.95

AUTOMATIC DISTRIBUTORS

Your Powersports Distributor For

PARTS, ACCESSORIES & APPAREL

SNOWMOBILE • OFFROAD • STREET • ATV/UTV • PWC/MARINE • TRAILER • OUTERWEAR

FAST SAME DAY SHIPPING

TRAILER CATALOG 281

tires & wheels

axles, hubs & springs

tongue accessories

hitches

electrical

brake parts

trailer hardware

locks & pins

towing & loading

tie downs

tools

chemicals

TRAILER



"World's Finest Cold Weather Compound"
#1 Brand for consumers and professionals on the market today.

EPOXY ADHESIVES

J-B WELD ORIGINAL COLD WELD FORMULA STEEL REINFORCED EPOXY

- Great for household repairs, automotive, plumbing, marine, crafts and more
- Its two-part epoxy system that provides strong, lasting repairs to metal and multiple surfaces
- Mixed at a ratio of 1:1, it forms a permanent bond and can be shaped, tapped, filed, sanded and drilled after curing
- At room temperature, J-B Weld sets in 20-25 minutes to a dark grey color
- A full cure is reached in 15-24 hours, and sets to a hard bond overnight
- Has a tensile strength of 3960 PSI
- Can withstand temperatures up to 550° F when fully cured
- Sold each
- Display packaged

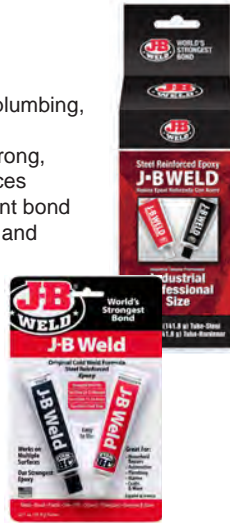

DESCRIPTION	MFG #	PART #	
J-B Weld	8265-S	JB8265	6.99

J-B WOODWELD QUICK-SETTING WOOD EPOXY

J-B WoodWeld is a fast setting two-part epoxy system formulated for wood bonding and repairs. When fully cured it can be shaped, tapped, filed, sanded and drilled. It provides a lasting permanent bond that is stronger than the wood! J-B WoodWeld has a 1:1 mixing ratio, sets in 6 minutes and cures in 1-3 hours. Rated at a tensile strength of 1800 PSI, J-B WoodWeld cures to a light tan color.

- Great For:
- Indoor/Outdoor
 - Furniture
 - Doors
 - Windows
 - Trim/Molding
 - Decks & More



DESCRIPTION	MFG #	PART #	
J-B WoodWeld Syringe - 25 mL	50151	446018	9.99

J-B CLEARWELD QUICK SETTING EPOXY

ClearWeld is a quick setting, multipurpose two part epoxy that provides a strong and lasting bond on most surfaces including tile, most plastics, ceramic, glass, wood and metal. ClearWeld is designed to cure with a clear, transparent bond when used at thicknesses of less than 15 mil. ClearWeld has a 1:1 mixing ratio, sets in 5 minutes and cures in 1 hour. With a tensile strength of 4400 PSI, ClearWeld sets to a hard, permanent bond.

- Great For:
- Tile
 - Most Plastics
 - Ceramic
 - Glass
 - Wood
 - Metal



DESCRIPTION	MFG #	PART #	
J-B ClearWeld Syringe - 25mL	50112	446015	7.99

J-B MARINE WELD MARINE EPOXY

- J-B MarineWeld is a specially formulated two-part epoxy cold weld system that provides for strong, lasting repairs for bonding different or similar surfaces, such as aluminum, metal, composites, fiberglass and others
- Great for use on boats, personal watercraft, in/outboard engines, deck and hull accessories
- Sets in 20-25 minutes at room temperature and is fully cured to a dark grey color in 15-24 hours
- Once cured, it can be shaped, tapped, filed, sanded and drilled and will retain its strength above or below the water's surface
- MarineWeld has a 1:1 mixing ratio
- Tensile strength of 3960 PSI
- Sold each
- Display packaged



DESCRIPTION	MFG #	PART #	
J-B MarineWeld	8272	JB8272	8.99
J-B MarineWeld Syringe - 25 mL	50172	446019	10.99

J-B KWIKWELD QUICK-SETTING STEEL REINFORCED EPOXY

- J-B KwikWeld is a quick-setting steel reinforced epoxy
- J-B KwikWeld is a fast setting version of The Original J-B Weld two-part epoxy cold weld system
- Provides strong, lasting repairs to metal and multiple other surface types
- Great for household repairs, automotive, plumbing, marine, crafts and more
- After mixing, it forms a permanent bond and can be shaped, tapped, filed, sanded and drilled after curing
- 1:1 mixing ratio
- Sets in 6 minutes and is fully cured in 4-6 hours
- Cures to a dark grey color
- Rated at a tensile strength of 2424 PSI
- Will withstand temperatures up to 300° F
- Sold each
- Display packaged



DESCRIPTION	MFG #	PART #	
J-B KwikWeld	8276	JB8276	8.99
J-B KwikWeld Syringe - 25 mL	50176	446020	8.99

J-B PLASTICWELD QUICK SETTING EP

PlasticWeld is a specially formulated two-part adhesive and epoxy filler system that provides for strong, lasting repairs. PlasticWeld will bond a variety of surfaces, such as metal, composites, fiberglass and others. PlasticWeld sets in 5 minutes at room temperature and is fully cured in 1 hour. Using a 1:1 mixing ratio, PlasticWeld combines to a tensile strength of 3200 PSI and cures to an off-white color.



DESCRIPTION	MFG #	PART #	
J-B PlasticWeld Syringe - 25 mL	50132	446016	7.99

tires & wheels
axles, hubs & springs
tongue accessories
hitches
electrical
brake parts
trailer hardware
locks & pins
towing & loading
tie downs
tools

chemicals

TRAILER



"World's Finest Cold Weather Compound"
#1 Brand for consumers and professionals on the market today.

EPOXY ADHESIVES

J-B MINUTEWELD

MinuteWeld is a fast setting, multipurpose two part epoxy that provides a strong and lasting bond on most surfaces including tile, most plastics, ceramic, glass, wood and metal. MinuteWeld is designed to bond instantly and cure with a clear, transparent bond when used at thicknesses of less than 15 mil. MinuteWeld has a 1:1 mixing ratio, sets in 1 minute and will fully cure overnight. With a tensile strength of 3200 PSI, MinuteWeld sets to a hard, permanent bond.

- Stronger than Super glues
- Highest Strength in Class
- Our Clearest Weld
- Features No Waste, No mess cap.



DESCRIPTION	MFG #	PART #	
J-B MinuteWeld Syringe - 25 mL	50101	446014	8.99

EPOXY PUTTY STICKS

J-B WATERWELD WILL SET UNDER WATER!

- WaterWeld will plug or seal leaks and patch holes and cracks in almost anything
- Ideal for repairing plumbing, fuel tanks, tub and shower, drains, pool and spa, boats and potable water tanks; setup occurs even under water
- After curing, it can be drilled, tapped, filed, sanded and painted
- Has a set time of 15-25 minutes and sets hard in one hour
- Cures to an off-white color
- Rated at a tensile strength of 900 PSI
- Will withstand temperatures up to 300° F
- Sold each. Display packaged.



DESCRIPTION	MFG #	PART #	
J-B WaterWeld	8277	JB8277	9.99

EPOXY PUTTY STICKS

J-B WELD KWIK WOOD REPAIR AND REBUILD ANYTHING MADE OF WOOD!

- Repair and rebuild anything made of wood such as dry rot, knot holes, window and door frames, screw holes, insect damage, furniture and carvings, gouges and cracks, and PVC trim board
- KwikWood is a hand-mixable epoxy putty, formulated to repair and rebuild wood
- After mixing, it cures to the same density as wood and becomes an integral part of the repair
- For use on exterior or interior applications, it contains no solvents, will not rot, shrink, crack or pull away
- KwikWood has a 15-25 minute work life
- After 60 minutes, it can be machined, drilled, tapped, sanded, filed and painted
- Stronger than wood, KwikWood dries to a light tan color
- Sold each. Display packaged.



DESCRIPTION	MFG #	PART #	
J-B Kwik Wood	8257	JB8257	8.99

J-B PLASTICBONDER BODY PANEL ADHESIVE, FILLER & SEALER

Strength 3770 PSI
Set Time 15 Minutes
Sand in 30 Minutes
Dries Tan

- Great For:
- Filling Dents
 - Bumpers
 - Automotive Trim
 - Composite Panels
 - Interior & Exterior Plastic Parts
 - Polypropylene & Polyethylene Plastics
 - Fiberglass

Plastic Bonder has a 1:1 mixing ratio, sets in 15 minutes and can be sanded after 30 minutes. With a tensile strength of 3770 PSI, Plastic Bonder sets to a tan color and cures to a hard, permanent bond.



DESCRIPTION	MFG #	PART #	
J-B PlasticBonder Syringe - 25 mL	50133	446017	8.99

SPECIALTY PRODUCTS

J-B HIGHHEAT TEMPERATURE RESISTANT EPOXY PUTTY

Strength 800 PSI at Room Temp. 600 PSI at 400° F
Set Time 1 Hour
Functional Cure 8 Hours
Dries Machine Grey
Great For:

- Exhaust Manifolds
- Tail Pipes
- Mufflers
- Engine Blocks
- Duct Work
- Machinery

HighHeat is a hand mixable epoxy putty stick specifically formulated to bond and repair materials that will be exposed to high temperatures in automotive and industrial maintenance applications.



DESCRIPTION	MFG #	PART #	
J-B HighHeat Epoxy Stik	8297	446003	10.99

J-B WELD HI TEMP RED SILICONE

- RTV all purpose technology
- Set time 1 hour
- Temp. Resistant up to 650° F
- Gasket Maker and Sealant
- Oil Pans and Valve Covers
- Exhaust Manifolds and Water Pumps
- Timing and Differential Covers



DESCRIPTION	MFG #	PART #	
J-B High Temp. Red Acetoxy - 3 oz.	31314	446007	7.99

tires & wheels

axles, hubs & springs

tongue accessories

hitches

electrical

brake parts

trailer hardware

locks & pins

towing & loading

tie downs

tools

chemicals

TRAILER

CHEMICALS



"World's Finest Cold Weather Compound"
#1 Brand for consumers and professionals on the market today.

SILICONE SEALANTS

J-B WELD CLEAR SILICONE

- Sealant & Adhesive
- RTV all purpose technology
- Set time 1 hour
- Fully cured 24 hours
- Waterproof
- All purpose (auto, household)



DESCRIPTION	MFG #	PART #	
J-B Clear RTV Acetoxy - 3 oz.	31310	446005	6.99

J-B WELD BLACK SILICONE

- RTV all purpose technology
- Set time 1 hour
- Fully cured 24 hours
- Mold and Mildew Resistant
- Auto and Household
- Bonding and Sealing
- Weather Stripping, Moldings



DESCRIPTION	MFG #	PART #	
J-B Black RTV Acetoxy - 3 oz.	31319	446009	5.99

J-B WELD BLUE SILICONE

- RTV all purpose technology
- Set time 1 hour
- Sensor Safe
- Gasket Maker and Sealant
- Auto and Household
- Timing Gear Covers
- Transmission & Oil Pans



DESCRIPTION	MFG #	PART #	
J-B Blue RTV Acetoxy - 3 oz.	31316	446008	5.99

J-B WELD WHITE SILICONE

- RTV 100% Silicone
- Waterproof Sealant & Adhesive
- Set time 1 hour
- Mold and Mildew Resistant
- Tub & Shower, Sinks & Bathroom Fixtures
- Windows, Interior Trim, Door Frames
- Moldings and Lens Housing



DESCRIPTION	MFG #	PART #	
J-B White RTV Acetoxy - 3 oz.	31312	446006	6.99

J-B WELD ULTIMATE GREY SILICONE

- Oxime RTV 100% Silicone
- Gasket Maker and Sealant
- High Torque Load Applications
- Import Cars (Honda, Toyota, Nissan etc.)
- Maximum Oil Resistance
- Set time 1 hour
- Temperature Resistant up to 500° F
- Intake Manifolds
- Low Odor, Non Corrosive and Sensor Safe
- Oil Pans and Timing Gear Covers
- Transmission Pans and Cam Covers



DESCRIPTION	MFG #	PART #	
J-B Ultimate Grey Oxime - 3 oz.	32327	446012	8.99
J-B Grey Water, Pump, & Thermostat Oxime - 5 oz.	32507	446010	3.99

J-B WELD ULTIMATE BLACK SILICONE

- Oxime RTV 100% Silicone
- Maximum Oil Resistance
- Set time 1 hour
- Temperature Resistant up to 500° F
- Low Odor and Sensor Safe
- Oil Pans and Valve Covers
- Transmission Pans
- Timing Gear Covers



DESCRIPTION	MFG #	PART #	
J-B Ultimate Black Oxime - 3 oz.	32329	446013	8.99
J-B Maxi Black Oxime - 5 oz.	32509	446011	3.99

J-B WELD PERMA-LOCK LOW VISCOSITY THREADLOCKER

- Low viscosity, penetrating grade threadlocker
- For use on fasteners, screws, electrical connectors and pre-assembled parts
- Temperature resistant to 300 degree Fahrenheit
- Penetrates between part surfaces, so no disassembly is required
- OEM approved

DESCRIPTION	MFG #	PART #	
6 mL	29006	446027	6.95



tires & wheels
axles, hubs & springs
tongue accessories
hitches
electrical
brake parts
trailer hardware
locks & pins
towing & loading
tie downs
tools
chemicals

TRAILER



"World's Finest Cold Weather Compound"
#1 Brand for consumers and professionals on the market today.

THREADLOCKERS

J-B Weld threadlockers are superior to conventional mechanical devices because they secure the entire fastener assembly against loosening from shock and vibration so fastener clamping forces are maintained. Threadlockers seal the threads against leakage and prevent rust and corrosion.

J-B WELD PERMA-LOCK MEDIUM STRENGTH THREADLOCKER



- 1/4" to 1" fasteners that have a slight oil film.
- Prevents vibration loosening.
- Temperature resistant to 300°F.
- Features a no spill, drip or clog cap.
- OEM approved.
- Suggested applications: rocker arms, stud bolts, fasteners & bushings, loose screws, vibration sensitive items.



DESCRIPTION	MFG #	PART #	
6 mL	24206	JB24206	6.99
13 mL	24213	JB24213	16.99
36 mL	24236	446025	24.99

J-B WELD PERMA-LOCK HIGH STRENGTH THREADLOCKER



- For heavy-duty applications. Temperature resistant to 300°F.
- Especially well suited for permanently locking studs.
- Locks against vibration loosening.
- Requires extra effort or special tools for removal.
- Features a no spill, drip or clog cap.
- OEM approved.
- Suggested applications: rocker arms, stud bolts, fasteners & bushings, loose screws, vibration sensitive items.

DESCRIPTION	MFG #	PART #	
6 mL	27106	446021	6.99
13 mL	27113	446022	10.99
36 mL	27136	446023	24.99

- tires & wheels
- axles, hubs & springs
- tongue accessories
- hitches
- electrical
- brake parts
- trailer hardware
- locks & pins
- towing & loading
- tie downs
- tools

chemicals

TRAILER

SEE ORDERING DIFFERENTLY:

Various Ordering Options
Convenient 24/7 On-Line Management
An Extensive Inventory

Same day and
Saturday Shipping

**AUTOMATIC
DISTRIBUTORS**

www.autodist.com



FAST SAME DAY SHIPPING

- tires & wheels
- axles, hubs & springs
- tongue accessories
- hitches
- electrical
- brake parts
- trailer hardware
- locks & pins
- towing & loading
- tie downs
- tools



PERMATEX

ELIMINATOR II® ENGINE DEGREASER

Quickly dissolves and removes grease, oil and dirt from all types of equipment. Cleans iron, steel, aluminum, magnesium and copper. Not harmful to metal, rubber, plastic, or concrete. Rinses off easily with water. Suggested applications: engines, garage floors, tools, machinery. Sold each.

DESCRIPTION	QTY/CS	MFG #	PART #	
15 oz Aerosol Can	12	80043	AG80043	12.95



CHAIN LUBE

Cleans, lubricates, extends life and protects all types of roller chains, gears and cables that operate under exposed conditions. Easy-to-apply foaming action assures effective application. Repels dirt, sand, dust. Minimal "throw - off". Contains no ODC's. Suggested Applications: Ideal for any chain-driven tool or vehicle such as motorcycles, mopeds, chain saws, lawn mowers and bicycles. Sold each.

DESCRIPTION	QTY/CS	MFG #	PART #	
5 oz Aerosol Can	12	80075	AG80075	7.95



BATTERY CLEANER

Spray it on and wash corrosion off. Works in just three minutes. Suggested applications: automotive, marine, farm machinery and motorcycle batteries. Sold each.

DESCRIPTION	QTY/CS	MFG #	PART #	
5.75 oz Aerosol Can	12	80369	AG80369	7.95



WHITE LITHIUM GREASE

All-purpose white lubricant for metal-to-metal and metal-to-plastic applications. Protects against rust and makes surfaces friction-free. Stainless and nontoxic. Contains no ODCs. Withstands moisture and high heat. Suggested applications: door hinges, hood latches, trunk latches, hatchback struts, seat tracks, garage door and delivery truck door tracks. Sold each.

DESCRIPTION	QTY/CS	MFG #	PART #	
10.75 oz Aerosol Can	12	81981	AG81981	10.95



PRO-STRENGTH BRAKE & PARTS CLEANER

Aggressively penetrates, dissolves, and removes oil, grease, and brake fluid. Dries fast with no residue. Developed for brake professionals. Contains no ODCs. Suggested applications: all brake systems, C.V. joints, machinery, tools, farm equipment. Sold each.

DESCRIPTION	QTY/CS	MFG #	PART #	
19 oz Aerosol Can	12	82606	AG82606	10.95



TRAILER

PERMATEX HAND CLEANERS

PERMATEX FAST ORANGE PUMICE AND SMOOTH LOTION HAND CLEANER

The #1 selling, biodegradable, waterless, petroleum solvent-free hand cleaner that contains no harsh chemicals, petroleum solvents or ammonia that can sting cuts or abrasions. Pure, fresh-smelling natural citrus power does the cleaning. Fortified with aloe, lanolin, glycerin, and other skin conditioners to soothe raw, rough hands. Fine Pumice deep cleans the toughest dirt. Works great on laundry stains (smooth lotion only), scuff marks, tile floors, pet odors and many other household cleaning needs. * Readily Biodegradable according to OECD Method 301E. Sold each.



PUMICE LOTION

DESCRIPTION	QTY/CS	MFG #	PART #	
7.5 Fluid oz Bottle	12	25108	AG25108	4.95
1 Gallon Bottle w/Pump	4	25219	AG25218	27.95

SMOOTH LOTION

DESCRIPTION	QTY/CS	MFG #	PART #	
7.5 Fluid oz Bottle	12	23108	AG23108	4.95
1 Gallon Bottle w/Pump	4	23218	AG23218	30.95

PERMATEX FAST ORANGE PUMICE BAR HAND SOAP

Fast Orange® Pumice Bar Hand Soap is a new way to clean everyday soils from hands. The large, 5.75 oz soap bar contains fine pumice for thorough cleaning and leaves hands feeling soft. Ideally suited for the cleaning needs of automotive technicians. Suggested Applications: Removes, oil, grease, grime, paint and other everyday soils. Sold each.



DESCRIPTION	MFG #	PART #	
5.75 oz Bar	25575	AG25575	3.95

PERMATEX FAST ORANGE HAND CLEANER WIPES

Removes the toughest grease, tar, grime, ink, paints, sealants, adhesives and other difficult soils. Removes grease, grime, oils, soil, gasket cement, glues, and inks. Each pre-moistened wipe has a textured surface on one side that is ideal for cleaning heavy duty soils from hands, tools and work areas. The wipes also have a smooth side for general purpose cleaning. Readily Biodegradable according to OECD Method 301E. 72 Count.



DESCRIPTION	MFG #	PART #	
72 Count Wipes	25051	AG25051	26.95

- tires & wheels
- axles, hubs & springs
- tongue accessories
- hitches
- electrical
- brake parts
- trailer hardware
- locks & pins
- towing & loading
- tie downs
- tools
- chemicals

TRAILER



FAST SAME DAY SHIPPING



PERMATEX MEDIUM STRENGTH THREADLOCKER BLUE GEL

(GEL TWIST APPLICATOR)

OEM specified. Gel formula provides "liquid-reliability" without drips, globs, mess or waste. The GEL TWIST™ pin-point applicator puts the Threadlocker right where you want it...on the part! All-purpose, medium strength threadlocker. Ideal for all nut and bolt applications 1/4" to 3/4" (6mm to 20mm). Eliminates need for stocking expensive lock nuts and lock washers. Locks and seals while preventing parts loosening due to vibration. Protects threads from corrosion. Removable with hand tools for easy disassembly. Conforms to ASTM D 5363 AN0321 (Mil-S-46163A, Type II, Grade N).

DESCRIPTION	MFG #	PART #	
10g Gel Twist Applicator, Carded	24010	AG24010	29.95

PERMATEX HIGH STRENGTH THREADLOCKER RED GEL

(GEL TWIST APPLICATOR)

OEM specified. Gel formula provides "liquid-reliability" without drips, globs, mess or waste. The GEL TWIST™ pin-point applicator puts the Threadlocker right where you want it...on the part! High strength threadlocker for heavy-duty applications 3/8 inch to 1 inch (10mm to 25mm). Especially well-suited for permanently locking studs and press fits. Adds 3,000 PSI holding power on slip and press fit assemblies. Replaces set screws and snap rings. Locks against vibration loosening. May require heat or special tools for removal. Conforms to ASTM D5363 AN0221 (Mil-S-46163A, Type I, Grade K).

DESCRIPTION	MFG #	PART #	
10g Gel Twist Applicator, Carded	27010	AG27010	26.95



THE GEL TWIST ADVANTAGE

GEL Twist Threadlocker will not drip or run like traditional liquid threadlockers and is easily portable. Threadlocker Gel stays on the part which reduces waste and makes it great for use in vertical applications. The extended nozzle allows for easy application on "hard to reach" locations.

PERMATEX ULTRA-BLACK GASKET MAKER SEALS EXHAUST JOINTS

OEM specified. For dealership warranty requirements, Ultra Black® ensures extended drivetrain warranty compliance. Fast-curing formula. Sensor-safe, low odor, noncorrosive. Meets performance specs of OE silicone gaskets. Retains high flexibility, oil resistant properties through use of a patented adhesion system. Temperature range -65° F to 500° F (-54° C to 260° C) intermittent; resists auto and shop fluids and vibration.

DESCRIPTION	MFG #	PART #	
3.35 oz Tube, Carded	82180	AG82180	9.95

PERMATEX ULTRA-BLUE RTV SILICONE GASKET MAKER

OEM specified. Designed specially for high-torque and high vibration applications, like those common in import engines, this premium RTV gasket maker exceeds manufacturers' performance requirements. Sensorsafe, low odor, and noncorrosive. Maximum vibration resistance, with outstanding resistance to oils, cooling and shop fluids. Guaranteed not to leak. Temperature range -65° F to 500° F (-54° C to 260° C) intermittent.

DESCRIPTION	MFG #	PART #	
3.35 oz Tube, Carded	81724	AG81724	12.95

PERMATEX ANTI-SEIZE LUBRICANT

A highly refined blend of aluminum, copper and graphite lubricants. Use during assembly to prevent galling, corrosion and seizing due to weathering or chemicals. Anti-Seize assures easier disassembly. Temperature range: -60° F to 1600° F (-51° C to 871° C). Salt, corrosion and moisture resistant – ideal for marine use.

DESCRIPTION	MFG #	PART #	
1 oz Tube, Carded	81343	AG81343	5.95
4 oz Brush Top Bottle	80071	AG80071	12.95

PERMATEX NON-CHLORINATED BRAKE & PARTS CLEANER

Penetrates, dissolves and removes dirt and oil from brake systems and metal parts. Safer for aluminum. Leaves no contaminant-attracting residue or chlorinated solvent run-off. Helps manage EPA halide limits. *NFPA Fire Code 30B.

DESCRIPTION	MFG #	PART #	
20 oz Aerosol Can	82220	AG82220	8.95



tires & wheels
axles, hubs & springs
tongue accessories
hitches
electrical
brake parts
trailer hardware
locks & pins
towing & loading
tie downs
tools

chemicals

TRAILER

PRO GREASE GUN

- Professional quality heavy duty construction and chrome plated finish for long service life
- Short stroke "lever action" for easy use in tight spaces
- Vented zinc die cast head cap
- Positive lock for easy filling
- Air bleeder valve eliminates air lock
- Knurled thick wall barrel for secure grip
- Comfort grip lever handle
- Uses standard 14 oz grease cartridge



DESCRIPTION	MFG #	PART #	
Grease Gun	W54202	W54202	25.95

PRO PISTOL GRIP GREASE GUN

- Professional quality heavy duty construction and chrome plated finish for long service life
- Pistol grip action for easy use
- Vented zinc die cast head cap
- Positive lock for easy filling
- Air bleeder valve eliminates air lock
- 2 way filling: standard 14 oz grease cartridge or bulk
- Comfort grip lever handle



DESCRIPTION	MFG #	PART #	
Grease Gun	W54204	260066	24.95

MINI GREASE GUN WITH GREASE

- Heavy duty construction
- "Pistol Grip" action for easy use in tight spaces
- Vented zinc die cast head cap
- Positive lock for easy filling
- Air bleeder valve eliminates air lock
- Uses 3 oz grease cartridge (included)
- Replacement grease cartridge part # 260068



DESCRIPTION	MFG #	PART #	
Mini Grease Gun	W54205	260067	19.95

2-PACK 3 OZ MULTI PURPOSE GREASE

- Multi purpose lithium based grease is designed for light duty applications which require extended lubrication
- For light duty automotive, industrial, agricultural or commercial equipment
- Smooth consistency, water resistant and extremely stable
- Use on springs, water pumps, bearings, chassis fittings and any general lubrication projects



DESCRIPTION	MFG #	PART #	
2-Pack 3 oz Multi Purpose	W54206	260068	7.95

FAST SAME DAY SHIPPING

tires & wheels

axles, hubs & springs

tongue accessories

hitches

electrical

brake parts

trailer hardware

locks & pins

towing & loading

tie downs

tools

chemicals

TRAILER



LUBRIMATIC

- tires & wheels
- axles, hubs & springs
- tongue accessories
- hitches
- electrical
- brake parts
- trailer hardware
- locks & pins
- towing & loading
- tie downs
- tools
- chemicals

LEVER ACTION GREASE GUN

Three way loading. Heavy duty performance. Uses 14 oz. cartridge. Zinc plated.



DESCRIPTION	MFG #	PART #	
Lever Action Grease Gun	30-465	LB11155	40.95

MARINE CORROSION CONTROL & TRAILER BEARING GREASE

Special calcium sulfonate complex, water insoluble formula ideal for marine applications. Provides excellent corrosion protection under severe conditions caused by salt water and air. Use on wheel bearings (including disc brake wheel bearings), swivel hinges, pins, winches and anchor chain reels.



DESCRIPTION	QTY/CS	MFG #	PART #	
1 lb Resealable Tub	12	11404	LB11404	13.95
14 oz Cartridge	10	11402	LB11402	13.95

WHITE LITHIUM GREASE

Includes zinc additives for a clean, white color. Ideal for general home, shop, marine, snowmobile and industrial applications. Contains no silicones and can be used on plastic components.



DESCRIPTION	QTY/CS	MFG #	PART #	
1 lb Resealable Tub	12	11350	LB11350	10.95
14 oz Cartridge	10	11354	LB11354	11.95

ELECTRICAL CONTACT GREASE

Electrical Contact Grease is a state-of-the-art product which is characterized by exceptional mechanical stability. The very high load carrying ability, excellent resistance to water, oxidation and corrosion, and outstanding performance in a wide temperature range, make it a high performance premium grease. It contains no heavy metals or other harmful or environmentally undesirable additives, such as phosphorus, chlorine, zinc, phenols, antimony, barium or lead. Sold each.



DESCRIPTION	QTY/CS	MFG #	PART #	
2 oz Tube	12	11755	LB11755	12.95

WHITE LITHIUM GREASE

A quality white lithium grease with exceptional consistency. Perfect for all engine rebuilding, metal-to-metal and electrical connection applications. Sold each.



DESCRIPTION	QTY/CS	MFG #	PART #	
10 oz Tube	12	11395	LB11395	11.95

STORAGE FOGGING OIL

Protects internal components of 2- and 4-cycle engines from rust, corrosion or seizing during seasonal storage. Displaces moisture on all electrical motors, wet engines and equipment. Frees and loosens rusted nuts, bolts and parts in a super penetrating action. Lubricates and silences irritating squeaks. Cleans and protects metal surfaces. Sold each.



DESCRIPTION	QTY/CS	MFG #	PART #	
9.75 oz Can	12	11412	LB11412	19.95

HIGH-VISCOSITY 80w/90 GEAR LUBE

Ideal for modern outboard and stern drive lower units. Meets or exceeds API-MT-1 and GL-5 ratings. Will not void manufacturer's warranties. Sold each.



DESCRIPTION	QTY/CS	MFG #	PART #	
1 Quart	12	11552	LB11552	20.95

TRAILER

1-9

1/2 Dr. Sockets
Performance Tool.....244

1/2 Drive. Extensions
Performance Tool.....242

1/4 Inch Adapter
Performance Tool.....241

1000 Lumen Flashlight
Performance Tool.....269

12 Volt Utility Lights
Buyers.....98

12V Corded Magnetic Work Light
Wes Barg.....96

12V Outlet
Hopkins.....109
SPI.....223

12V Power Socket
Hopkins.....109

12V Tire Inflator
Performance Tool.....216

2 In 1 Stripper / Crimper
Performance Tool.....251

2 Part Epoxy
JB Weld.....282

4 Way Folding Wrench
Performance Tool.....271

4 Wire Flat Extensions
Hopkins.....121

4 Wire Flat Trailer End
Hopkins.....121

4/5 Flat Wire Connectors
Hopkins.....120

4-Hole Hub.....23

4-Pole Round Connector
Hopkins.....122

4-Way Flat Tester
Hopkins.....119

4-Way Wire Harness
Wes Barg.....107

4-Way Wrench
Performance Tool.....19

4-Wire Matched Set
Hopkins.....120

4-Wire Multi Tow Kit
Hopkins.....128-129

5-Hole Hub.....23

5-Pole Round Connector
Hopkins.....122

5th Wheel Lock
Tri-Max.....171

5-Wire Flat Harness
Hopkins.....120
Tow Ready.....106
Wes Barg.....106

5-Wire Flat Matched Set
Hopkins.....120

6/7 Pole Trailer Cable
Hopkins.....119

6-Pole Round Connector
Hopkins.....122

6-Way Connector
Wes Barg.....102

7-Way Connector
Wes Barg.....102

7-Way Emulator
Tekonsha.....135

7-Way Extension
Tow Ready.....105

A

ACF-50
Corrosion Block.....279
Corrosion Protectant.....279
Waterproof Grease.....279

Adapter
Performance Tool.....241

Adjustable Ball Mount
Buyers.....59-61

Adjustable Channel Mount
Buyers.....52

Adjustable Eye Assembly
Buyers.....69

Adjustable Hitch
Buyers.....61
Tri-Max.....61

Adjustable Keel Roller Bracket
Smith.....200

A-Frame Coupler
Buyers.....51-52
Fulton.....52

A-Frame Jack
Bulldog.....47
Buyers.....45

Alarm Lock Cable
Tri-Max.....173

Alko Brake Parts
Tekonsha.....150

Allen Key
Performance Tool.....246

Allen Wrench
Performance Tool.....246

Alternator Tester
Performance Tool.....219

Aluminum Polish Kit
Performance Tool.....267

Anchor Ring
Caliber.....193

Ancra
Rat Pak.....206
Ratchet Strap.....206
Soft Hook Extension.....206
Tie Down Strap.....206

Angle Bracket
Smith.....200

Angle Grinder
Performance Tool.....257

Angled Bunk Bracket
Smith.....202

Anti Seize Lubricant
Permatex.....288

Arched Ramp.....184

Auxiliary Light
Peterson.....98

Axle
Reliable.....22

Axle Hanger Kit
Reliable.....39

Axle Nut
Reliable.....23

Axle Strap
Erickson.....210

Axle Tie Plate
Smith.....36

B

Back Up Camera
Hopkins.....131

Back Up Light
Peterson.....76-99

Ball End Allen Set
Motion Pro.....246
Performance Tool.....246

Ball Mount Kit
Buyers.....60

Ball Pein Hammer
Performance Tool.....256

Basic Wiring Solutions
Hopkins.....122

Battery Cases
Tekonsha.....143

Battery Cleaner
Permatex.....286

Battery Load Tester
Performance Tool.....219

Battery Siphon.....227

Battery Terminal Cleaner
Performance Tool.....220

Beacon/Strobe Light
Blazer.....77-86

Bearing Buddy
Bearing Buddy.....29
Bearing Lubber.....29
Bearing Protector.....29

Bearing Cone.....30-31

Bearing Cup.....30-31

Bearing Kit.....31

Bearing Lubber
Bearing Buddy.....29

Bearing Packer
Performance Tool.....225

Bearing Protector
Bearing Buddy.....29
Fulton.....29
Tie Down.....30

Bit Set
Performance Tool.....249

Black Silicone
JB Weld.....284

Blazer
Beacon/Strobe Light.....77-86
Flood Light.....77-86
Flood/Spot Light.....77-86
LED Bezel.....77-86
LED Combo Light Kit.....77-86
LED Light Bar.....77-86
LED Strobe.....77-86
LED Submersible Light Kit.....77-86
LED Tail Light.....77-86
LED Universal Tail Light.....77-86
LED Utility Light.....77-86
License Plate Bracket.....77-86
Low Profile Taillight.....77-86
Magnetic Work Light.....77-86
Mounting Brackets.....77-86
Plate Light.....77-99
Quick Connect Plugs.....77-86
Toggle Switch.....77-86
Wireless Light Management System.....77-86
Wireless Tow Light Kit.....77-86
Wiring Harness.....77-86

Blue Silicone
JB Weld.....284
Permatex.....288

- tires & wheels
- axles, hubs & springs
- tongue accessories
- hitches
- electrical
- brake parts
- trailer hardware
- locks & pins
- towing & loading
- tie downs
- tools
- chemicals

TRAILER

- tires & wheels
- axles, hubs & springs
- tongue accessories
- hitches
- electrical
- brake parts
- trailer hardware
- locks & pins
- towing & loading
- tie downs
- tools
- chemicals

TRAILER

Boat Guide On
Fulton 203

Bolt Assortment
Performance Tool..... 259

Bolt On Drawbar Mount
Buyers 64

Bolt On Receiver Tube
Buyers 67

Bonded Wire
Hopkins 130

Boot Brush
Performance Tool..... 266

Boot Tray
Performance Tool..... 266

Bottle Jack
Performance Tool..... 265

Bow Bell Roller
Smith 201

Bow Roller
Smith 201

Bow Safety Chain
Tie Down 199

Bow Stop
Smith 201

Braided Cable
Tri-Max 172

Brake Bleeder
Motion Pro..... 217

Brake Cleaner
Permatex..... 286
PJ1 276

Brake Control Information 134

Brake Control Installation Kit
Hopkins 147

Brake Control Mounting Kit
Hopkins 147

Brake Control Wiring Harness
Hopkins 146-147
Tekonsha 139-141

Brake Controller
Draw Tite..... 138
Hopkins 145
Reese 137
Tekonsha 135-136

Brake Controller Install Kit
Tekonsha 142

Brake Drum
Reliable 158

Brake Drum Hub
Tie Down 158

Brake Light Bar
Optronics 75-90

Brake Magnets
Tekonsha 149

Brake Rotor
Reliable 158

Break Away Knife
Performance Tool..... 255

Breakaway Switch
Hopkins 148
Tekonsha 144

Breakaway Systems
Hopkins 148
Tekonsha 143

Bronco
Hose Bender 233
Tire Inflator Kit..... 271

Brush
Performance Tool..... 257

Bulldog
A-Frame Jack..... 47
Coupler Locks 177

Jack Replacement Parts 48-49
Powered Jack..... 46
Square Jack 47
Swivel Jack 46-47

Bungee Cord
Erickson 211-212
Highlands 213

Bunk Bracket
Smith 202

Bunk Carpet
Smith 203

Bunk Guide On
Smith 204

Bunk Lubricant
Caliber 186

Bunk Slides
Caliber 185

Bunk Wrap
Caliber 186

Buyers
12 Volt Utility Lights..... 98
Adjustable Ball Mount 59-61
Adjustable Channel Mount..... 52
Adjustable Eye Assembly..... 69
Adjustable Hitch 61
A-Frame Coupler..... 51-52
A-Frame Jack 45
Ball Mount Kit 60
Bolt On Drawbar Mount..... 64
Bolt On Receiver Tube..... 67
Clevis Ball Mount 68
Combo Hitch 66
Continuous Hinge..... 162
Coupler Pins..... 179
Coupler Repair Kit..... 52
Couplers..... 51
Door Holds 160
Double Ball Mount..... 60
Drawbar Lock 72
Dual Receiver..... 63
Electric Jack 44
E-Track..... 164
Folding Handle 50
Foot Step..... 50
Hand Winch..... 198
Handle..... 162
Heavy Duty Ball Mount..... 58
Heavy Duty Couplers 51
Heavy Duty Draw Bar..... 58
Hinge..... 162
Hitch Adaptor 63
Hitch Pins 179
Hood Catch 162
Hood Latch..... 161
Latches..... 200
Lynch Pins..... 179
Magnetic Strobe Light 93
Marker Light 74
Nose Plate..... 72
Pintle Hook..... 68-69
Pintle Hook Bolt Kit 67
Pintle Hook Mount..... 67
Polymer Step..... 50
Quick Link 70
Ramp Plate Kit 185
Ratchet Strap 214
Receiver Extension 63
Receiver Hook..... 68
Receiver Step..... 63
Receiver Tube..... 62-63
Receiver Tube Adaptor 62-63
Recessed Ring..... 160
Safety Chains..... 70
Shackles..... 163

Spring Latch 200
Square Jack 45
Stake Pocket..... 163
Stop Light 74
Storage Boxes..... 50
Strobe Light..... 93
Surface Mount Ring 161
Swing Away Jack 44
Swivel Jack 44
Tongue Box..... 50
Tool Boxes..... 50
Top Wind Jack 45
Tow Light Kit 94
Tow Shackle..... 68
Towing Hook 68
Trailer Ball 54
Trailer Winch..... 198
Tri-Ball Mount..... 61
Tri-Ball With Hook 61
Tube Mount Jack..... 44
Turn Light..... 74
Utility Light..... 74
Wheel Lock 176

C

C Clamp
Performance Tool..... 256

Cable Lock
Tri-Max 172-174

Cable Lubber
Motion Pro..... 224

Cable Ties
Performance Tool..... 258
SPI 258

Caliber
Alumi-Skin 192
Alumi-Etch 192
Anchor Ring 193
Bunk Lubricant 186
Bunk Slides 185
Bunk Wrap 185-186
Edge Glides..... 186
Edge Glides 2.0..... 186
Flex Glides 187
Grab Handle..... 193
Low Pro Glides 187
Low Pro Grip Glides 188
Marine Slides 185
Moto-Ramp 191
Moto-Ramp Traction Bar..... 191
Multi-Glides 187
Prop Rod 193
Ramp Bridge 192
Ramp Glide Kit 188
Ramp Grips 192
Ramp Pro 2.0 191
Ramp Shield..... 190
Retractable Strap 193
Salt Shield 190
Ski Track 187
Track Saver..... 189
Traction Ladder 190
Trailer Glides..... 187
Trailer Prop 193
Trailer Slides 187-188
Trailer Spray Shield..... 190
Trax Grabber..... 189
Traxmat 189

Cam Lock Strap Erickson 207 Highlands 213	Clearance Lights Optronics 75-90 Peterson 76-99 Wes Barg 78-102	Convert-A-Ball 56 Convert-A-Ball Storage 56	tires & wheels
Candlepower Replacement Bulbs 98	Clevis Ball Mount Buyers 68	Corrosion Block ACF-50 279	axles, hubs & springs
Carburetor Pocket Tuner Mikuni 218	Clip On Mirror Cipa 183	Corrosion Control Grease Lubrimatic 290	tongue accessories
Carburetor Synchronizer Motion Pro 217	Coiled 4-Way Connector Wes Barg 107	Corrosion Protectant ACF-50 279	hitches
Cargo Bar Erickson 162, 212	Color Code Chart 132	Cotter Pin Reliable 23	electrical
Carlisle Inner Tube 14 Tire Tubes 14 Valve Stem 14	Combination Wrench Performance Tool 249	Counter Shaft Seal Puller Motion Pro 218	brake parts
Channel Lock Pliers Performance Tool 250	Combo Hitch uyers 66	Coupler Handle Fulton 52	trailer hardware
Channel Track Super Clamp 196	Combo Lever Set Motion Pro 20	Coupler Locks Bulldog 177 Tri-Max 170	locks & pins
Chisel Set Performance Tool 249	Combo Y Drive Wrench Motion Pro 236	Coupler Pins Buyers 179	towing & loading
Chrome Marker Light Optronics 75-90	Connector Mount Bracket Tow Ready 103-104 Wes Barg 103	Coupler Repair Kit Buyers 52	tie downs
Chrome Protector Erickson 212	Connectors, Vehicle Specific Hopkins 110	Couplers Buyers 51 Fulton 51	tools
Cipa Clip On Mirror 183 Tow Mirror 182-183	Contact Cleaner Maxima 276 PJ1 276	Covered Trailer Props Suspa 195	chemicals
Circuit Breaker Tekonsha 144	Contact Grease Lubrimatic 290	Crankshaft Puller Motion Pro 218	
Circuit Tester Hopkins 119 Performance Tool 220 Reese 105	Container Cap VP Racing 232	Creepers Performance Tool 266	
Claw Retriever Performance Tool 254	Container Hose VP Racing 232	Crimping Pliers Performance Tool 251	
Clear Silicone JB Weld 284	Containers VP Racing 231-232	Crimping Tool Performance Tool 251	
	Continuous Hinge Buyers 162	Cup Oil Filter Wrench Emgo 226	
		Cupped Wire Brush Performance Tool 257	



TRAILER

- tires & wheels
- axles, hubs & springs
- tongue accessories
- hitches
- electrical
- brake parts
- trailer hardware
- locks & pins
- towing & loading
- tie downs
- tools
- chemicals

D

Deep Sockets	
Performance Tool.....	243-244
Degree Wheel	
Motion Pro.....	220
Dexter Brake Parts	
Tekonsha	151-153
Dielectric Grease	
Lubrimatic.....	144
Digital Tire Gauge	
Performance Tool.....	19
Digital Tire Inflator	
Performance Tool.....	216
Disc Brake Kit	
Tie Down	156
Disc Brake Upgrade Kit	
Tie Down	156
Door Hasp	
Tri-Max.....	175
Door Holds	
Buyers.....	160
Double Ball Mount	
Buyers	60
Double Eye Spring	
.....	27
Drain Pan	
Performance Tool.....	226
Draw Tite	
Brake Controller	138
Electrical Connectors	123
Taillight Converter	123
Winch Mount	72
Winch Receiver Mount.....	72
Drawbar Lock	
Buyers.....	72
Drill Bit	
Performance Tool.....	252
Drop Light	
Performance Tool.....	267
Drum Pump	
Tera Pumps.....	235
Dual Receiver	
Buyers.....	63
Dual Wheel Jack	
Fulton	42
Duct Tape	
Performance Tool.....	258
Dust Cap	
.....	30

E

Ear Muffs	
Elvex	274
Electric Brake Assemblies	
Tekonsha	157
Electric Jack	
Buyers.....	44
Fulton	42
Electric Tire Pump	
Performance Tool.....	19
Electrical Connectors	
Draw Tite.....	123
Electrical Contact Grease	
Tekonsha	144

Elvex	
Ear Muffs.....	274
Go-Specs	274
Hearing Protection	274
Safety Glasses	274
Emergency Charger	
Performance Tool.....	223
Emgo	
Cup Oil Filter Wrench.....	226
Tire Pressure Gauge.....	216
Enforcer	
Trailer Tilt Prop.....	195
Engine Degreaser	
Permatex.....	286
Equalizer	
.....	28
Equalizer Kit	
Reliable	39
Erickson	
Axle Strap.....	210
Bungee Cord.....	211-212
Cam Lock Strap	207
Cargo Bar.....	162, 212
Chrome Protector.....	212
E-Track.....	164
Flat Bungee.....	211
Hand Winch Strap.....	214
Logistic Strap	210
Mini Winch.....	212
O-Track.....	161
Ramp Plate	185
Ratchet Strap	206-209
Recovery Strap	210
Retractable Ratchet Strap.....	207
Rope Ratchet.....	214
Rubber Handle Tie Downs.....	206-209
Rubber Tarp Strap	212
Stake Pocket Anchor.....	160
Strap Hanger.....	211
Surface Mount Ring	161
Tie Down Anchor.....	161
Tie Down Ring.....	160
Tie Down Strap	206-209
Tie Hooks.....	163
Tightening Bar.....	212
Tire Strap	272
Tow Hooks	164
Tow Ropes.....	210
Transom Tie Down.....	210
Transom/Bow Eyelet.....	212
Web Protector	212
Winch Strap.....	214
E-Track	
Buyers.....	164
Erickson	164
E-Track Beam Socket	
.....	164
E-Track Tie Off Ring	
.....	164
E-Track Tie Strap	
.....	164
Euro Bolt Kit	
Motion Pro.....	261
Extension Cord	
Performance Tool.....	267
Extensions	
Performance Tool.....	242
Extractor Set	
Performance Tool.....	252

F

Fast Orange	
Permatex.....	287
Fayette Brake Parts	
Tekonsha	155-156
Fender	
Fulton	15
Fender Brackets	
Smith.....	16
Tie Down	16
First Aid Kit	
Performance Tool.....	273
Flasher	
Peterson.....	76-99
Flasher Relay	
Peterson.....	76-99
Flashlight	
Performance Tool.....	269
Flat Bungee	
Erickson	211
Flat Wire Dust Cover	
Tow Ready.....	106
Flex Funnel	
Flo Tools	230
Flex Glides	
Caliber.....	187
Flex Socket	
Performance Tool.....	239
Flex Tubing	
Hopkins	119
Flex-Coil Connector Extensions	
Hopkins	112
Flexit Headlamp	
Risk	264
Flip Ramp	
Just Sail.....	194
Flip-Tip Pins	
Tri-Max	168
Flo Tools	
Flex Funnel	230
Funnel	228-230
Locking Oil Funnel	230
Multi Funnel.....	230
Shaker Siphon.....	227
Transmission Funnel.....	230
Flood Light	
Blazer.....	77-86
Peterson.....	95
Flood/Spot Light	
Blazer.....	77-86
Floor Anchor Kit	
Tri-Max	171
Floor Jack	
Performance Tool.....	265
Flush Mount Marker	
Optronics.....	75-90
Flush Mount Tail Light	
Optronics.....	75-90
Fog Light Kit	
Peterson.....	95
Fold Away Hinge	
Fulton	52
Folding Handle	
Buyers.....	50
Folding Knife	
Performance Tool.....	255
Folding Ramp	
.....	184
Foot Step	
Buyers.....	50

Frame Straps	
Smith.....	37
Fuel Transfer Pumps	
Tera Pump.....	234-235
Fulton	
A-Frame Coupler.....	52
Bearing Protector.....	29
Boat Guide On.....	203
Coupler Handle.....	52
Couplers.....	51
Dual Wheel Jack.....	42
Electric Jack.....	42
Fender.....	15
Fold Away Hinge.....	52
Grip Handle.....	52
Hitch Lock.....	176
Jack Replacement Parts.....	42
Spare Tire Carrier.....	17
Swivel Jack.....	42-43
Tow Connector.....	123
Trailer Winch.....	198
Winch Hook.....	199
Funnel	
Flo Tools.....	228-230
Mr. Funnel.....	228
Performance Tool.....	229
Fuse Assortment	
Performance Tool.....	259
Fuse Holders	
Tow Ready.....	130

G

Gas Prop	
Suspa.....	195
Gasket Maker	
Threebond.....	280
Gasket Scraper	
Performance Tool.....	255
Glue	
Threebond.....	280
Go-Specs	
Elvex.....	274
Grab Handle	
Caliber.....	193
Grease	
Lubrimatic.....	40
Grease Cap	30
Grease Gun	
Lubrimatic.....	40, 290
Performance Tool.....	40, 225, 289
Grease Gun Hose	
Lubrimatic.....	40
Grease Seal	31
Grip Handle	
Fulton.....	52
Grip Lock	
Threebond.....	280
Grunge Brush	257

H

Hair Pin	
Pivot Point.....	180
Halogen Work Light	
Peterson.....	97
Hammer	
Performance Tool.....	256
Hand Cleaner	
Permatex.....	287
Hand Soap	
Permatex.....	287
Hand Winch	
Buyers.....	198
Hand Winch Strap	
Erickson.....	214
Handle	
Buyers.....	162
Hardened Locking Pin	
Tri-Max.....	169
Hardline	
Hour Meter.....	221
Mini Tach.....	221
Protectant Cleaner And Polish.....	278
Sticker Off.....	278
Sticker On.....	278
Stop Watch.....	221
Hardware Assortments	
Performance Tool.....	259
Hayes Brake Parts	
Tekonsha.....	153-155
Hearing Protection	
Elvex.....	274
Heat Shrink	
Performance Tool.....	250
Heavy Duty Ball Mount	
Buyers.....	58
Heavy Duty Connectors	
Hopkins.....	123
Heavy Duty Couplers	
Buyers.....	51
Heavy Duty Draw Bar	
Buyers.....	58
Heavy Duty Spare Tire Carrier	
Tie Down.....	17
Heavy Duty Spring Hook	
Motion Pro.....	253
Hex Bit Sockets	
Performance Tool.....	245
Hi Temp Silicone	
JB Weld.....	283
Hi Temp Thread Locker	
Threebond.....	281
High Heat Epoxy	
JB Weld.....	283
Highlands	
Bungee Cord.....	213
Cam Lock Strap.....	213
Ratchet Strap.....	213
Retractable Ratchet Strap.....	213
Stainless Steel Ratchet Strap.....	213
Hinge	
Buyers.....	162
Hitch Adaptor	
Buyers.....	63
Hitch Alignment	
Tow Ready.....	18
Hitch Ball Cover	72
Hitch Ball Wrench	
Reese.....	72

Hitch Balls	54-56
Hitch Cable	
Tie Down.....	71
Hitch Lock	
Fulton.....	176
Hitch Locks	
Tri-Max.....	166-169
Hitch Pins	
Buyers.....	179
Hood Catch	
Buyers.....	162
Hood Latch	
Buyers.....	161
Hopkins	
12V Outlet.....	109
12V Power Socket.....	109
4 Wire Flat Extensions.....	121
4 Wire Flat Trailer End.....	121
4/5 Flat Wire Connectors.....	120
4-Pole Round Connector.....	122
4-Way Flat Tester.....	119
4-Wire Matched Set.....	120
4-Wire Multi Tow Kit.....	128-129
5-Pole Round Connector.....	122
5-Wire Flat Harness.....	120
5-Wire Flat Matched Set.....	120
6/7 Pole Trailer Cable.....	119
6-Pole Round Connector.....	122
Back Up Camera.....	131
Basic Wiring Solutions.....	122
Bonded Wire.....	130
Brake Control Installation Kit.....	147
Brake Control Mounting Kit.....	147
Brake Control Wiring Harness.....	146-147
Brake Controller.....	145
Breakaway Switch.....	148
Breakaway Systems.....	148
Circuit Tester.....	119
Connectors, Vehicle Specific.....	110
Flex Tubing.....	119
Flex-Coil Connector Extensions.....	112
Heavy Duty Connectors.....	123
LED Trailer Adapter.....	108
Mounting Brackets.....	119
Multi Tow Adapter.....	108
Multi Tow Kit.....	125-129
Plug And Play Adaptors.....	111
RV Blade Connectors.....	109
Tail Light Converter.....	123-124
Vehicle Specific	
Multi-Tow Connector.....	125-129
Vehicle Specific Wiring Kit.....	113-117
Wiring Installation Kit.....	124-125
Hose Bender	
Bronco.....	233
Hour Meter	
Hardline.....	221
Hub Kits	
Shipshape.....	24
Hydraulic Brake Assemblies	
Reliable.....	157

- tires & wheels
- axles, hubs & springs
- tongue accessories
- hitches
- electrical
- brake parts
- trailer hardware
- locks & pins
- towing & loading
- tie downs
- tools
- chemicals

TRAILER

- tires & wheels
- axles, hubs & springs
- tongue accessories
- hitches
- electrical
- brake parts
- trailer hardware
- locks & pins
- towing & loading
- tie downs
- tools
- chemicals

I

Ignition Tester	220
Impact Driver	
Performance Tool.....	248
Inner Tube	
Carlisle.....	14
Interchangeable Ball System	
Tow Ready.....	55

J

Jack Replacement Parts	
Bulldog.....	48-49
Fulton.....	42
Jack Stand	
Performance Tool.....	265
Jacks	42-48
JB Weld	
2 Part Epoxy.....	282
Black Silicone.....	284
Blue Silicone.....	284
Clear Silicone.....	284
Hi Temp Silicone.....	283
High Heat Epoxy.....	283
Kwikwood Epoxy.....	283
Low Viscosity Thread Locker.....	285
Marine Weld Epoxy.....	282
Minute Weld Epoxy.....	283
Perma-Lock Threadlocker.....	285
Plastic Weld Epoxy.....	282
Quick Epoxy.....	282
Ultimate Black Silicone.....	284
Waterweld Epoxy.....	283
White Silicone.....	284
Wood Weld Epoxy.....	282
Jon Boat Front Support	
Smith.....	204
Jumper Cables	
Yuasa.....	219
Just Sail	
Flip Ramp.....	194
Quick Snowmobile Tie Down.....	194
Snowmobile Tie Down System.....	194
Tie Down System.....	194
Tilt-EZ.....	194

K

Keel Pad	
Smith.....	201
Keel Roller	
Smith.....	200-201
Keel Roller Bracket	
Smith.....	202
Key Type Hose Clamp	
Performance Tool.....	261
Kwikwood Epoxy	
JB Weld.....	283

L

Laser Pointer	
Performance Tool.....	269
Latch Hook	
Tie Down.....	71
Latches	
Buyers.....	162, 200
Leaf Spring	26-27
Leak Down Tester	218
Leather Renew And Protect	
PJ1.....	276
LED Bezel	
Blazer.....	77-86
LED Combo Light Kit	
Blazer.....	77-86
LED Light Bar	
Blazer.....	77-86
LED Plate Light	
Optronics.....	75-99
LED Strobe	
Blazer.....	77-86
LED Submersible Light Kit	
Blazer.....	77-86
LED Tail Light	
Blazer.....	77-86
LED Trailer Adapter	
Hopkins.....	108
LED Trailer Light Kit	
Optronics.....	75-90
LED Universal Tail Light	
Blazer.....	77-86

LED Utility Light	
Blazer.....	77-86
LED Work Light	
Wes Barg.....	96
License Plate Bracket	
Blazer.....	77-86
Optronics.....	99
Peterson.....	99
Lift Arm	185
Lights	74-99
Liquid Tire Balance	
Ride-On.....	277
Lithium Grease	
Lubrimatic.....	290
Load Star	
Tires.....	10-11, 13
Loading Ramp	184
Lock Nuts	
Tie Down.....	34
Lock Pins	
Tri-Max.....	166-169
Locking Oil Funnel	
Flo Tools.....	230
Logistic Strap	
Erickson.....	210
Low Profile Taillight	
Blazer.....	77-86
Low Viscosity Thread Locker	
JB Weld.....	285
Lubrimatic	
Contact Grease.....	290
Corrosion Control Grease.....	290
Dielectric Grease.....	144
Grease.....	40
Grease Gun.....	40, 290
Grease Gun Hose.....	40
Lithium Grease.....	290
Mini Grease Gun.....	40
White Lithium Grease.....	290
Lug Wrench	
Performance Tool.....	19, 271
Lynch Pins	
Buyers.....	179

TRAILER

AUTOMATIC DISTRIBUTORS

Your Powersports Distributor For

PARTS, ACCESSORIES & APPAREL

SNOWMOBILE • OFFROAD • STREET • ATV/UTV • PWC/MARINE • TRAILER • OUTERWEAR

M

Magnet Kits	
Tekonsha	149
Magnetic Light	
Risk	263
Magnetic Retriever	
Performance Tool	254
Magnetic Strobe Light	
Buyers	93
Magnetic Tray	
Performance Tool	254
Magnetic Work Light	
Blazer	77-86
Marine Grade Padlock	
Tri-Max	175
Marine Slides	
Caliber	185
Marine Weld Epoxy	
JB Weld	282
Marker Light	
Buyers	74
Optronics	75-90
Peterson	76-99
Wes Barg	78-102
Maxima	
Contact Cleaner	276
MPPL Penetrant Lube	276
Waterproof Grease	276
Measuring Container	228
Mechanic Gloves	
Performance Tool	273
Metal Fenders	
Smith	16
Micro Marker Light	
Wes Barg	78-102
Micro Strobe Light	
Peterson	93
Mikuni	
Carburetor Pocket Tuner	218
Mini Brake Bleeder	
Motion Pro	217
Mini Fuse Assortment	
Performance Tool	259
Mini Grease Gun	
Lubrimatic	40
Performance Tool	289
Mini Light Bar	
Peterson	76-99
Mini Marker Light	
Optronics	75-90
Mini Sledge	
Performance Tool	256
Mini Tach	
Hardline	221
Mini Winch	
Erickson	212
Minute Weld Epoxy	
JB Weld	283
Mobile Task Light	
Risk	264
Motion Pro	
Ball End Allen Set	246
Brake Bleeder	217
Cable Lubber	224
Carburetor Synchronizer	217
Combo Lever Set	20
Combo Y Drive Wrench	236
Counter Shaft Seal Puller	218
Crankshaft Puller	218
Degree Wheel	220
Euro Bolt Kit	261
Heavy Duty Spring Hook	253
Mini Brake Bleeder	217
T Handle Rack	237
T Handle Spinner Wrench	236
T Handle Wrench	236-237
Tire Irons	20
Titanium Wrenches	249
Valve Spring Compressor	218
Valve Spring Tool	218

Moto-Ramp	
Caliber	191
Moto-Ramp Traction Bar	
Caliber	191
Mounting Brackets	
Blazer	77-86
Hopkins	119
MPPL Penetrant Lube	
Maxima	276
Mr. Funnel	
Funnel	228
Water Removing Funnel	228
Multi Funnel	
Flo Tools	230
Multi Tool	
Performance Tool	247
Multi Tow Adapter	
Hopkins	108
Multi Tow Kit	
Hopkins	125-129
Multimeter	
Performance Tool	219
Multi-Purpose Lift	
Performance Tool	265

N

Non-Chlorinated Brake Clean	
Permatex	288
Nose Plate	
Buyers	72
Nut Assortment	
Performance Tool	259
Nut Splitter	
Performance Tool	252

tires & wheels
axles, hubs & springs
tongue accessories
hitches
electrical
brake parts
trailer hardware
locks & pins
towing & loading
tie downs
tools
chemicals



TRAILER

- tires & wheels
- axles, hubs & springs
- tongue accessories
- hitches
- electrical
- brake parts
- trailer hardware
- locks & pins
- towing & loading
- tie downs
- tools
- chemicals

O

Off-Road Light

Peterson..... 95

Oil Filter Pliers

Performance Tool..... 226

Oil Filter Wrench

Performance Tool..... 226

Optronics

Brake Light Bar 75-90

Chrome Marker Light 75-90

Clearance Lights 75-90

Flush Mount Marker 75-90

Flush Mount Tail Light..... 75-90

LED Plate Light 75-99

LED Trailer Light Kit 75-90

License Plate Bracket 99

Marker Light 75-90

Mini Marker Light..... 75-90

Reflector Marker..... 75-90

Reflectors 75-92

Stop Light 75-90

Stop/Turn/Tail Lights 75-90

Submersible Light Kit 75-90

Thin Line Tail Light..... 75-90

Tractor Light..... 97

Trailer Light Kit..... 75-90

Turn Light 75-90

Universal Trailer Light Kit..... 75-90

O-Track

Erickson 161

Outboard Lock

Tri-Max..... 171

P

Pal Nuts

Smith 202

Penlight

Performance Tool..... 269

Performance Tool

1/2 Dr. Sockets..... 244

1/2 Drive. Extensions 242

1/4 Inch Adapter..... 241

1000 Lumen Flashlight..... 269

12V Tire Inflator..... 216

2 In 1 Stripper / Crimper 251

4 Way Folding Wrench..... 271

4-Way Wrench 19

Adapter..... 241

Allen Key 246

Allen Wrench..... 246

Alternator Tester 219

Aluminum Polish Kit 267

Angle Grinder 257

Ball End Allen Set 246

Ball Pein Hammer 256

Battery Load Tester..... 219

Battery Terminal Cleaner 220

Bearing Packer..... 225

Bit Set..... 249

Bolt Assortment..... 259

Boot Brush 266

Boot Tray..... 266

Bottle Jack..... 265

Break Away Knife..... 255

Brush..... 257

C Clamp 256

Cable Ties 258

Channel Lock Pliers 250

Chisel Set..... 249

Circuit Tester..... 220

Claw Retriever..... 254

Combination Wrench..... 249

Creoper 266

Crimping Pliers..... 251

Crimping Tool..... 251

Cupped Wire Brush..... 257

Deep Sockets 243-244

Digital Tire Gauge 19

Digital Tire Inflator 216

Drain Pan 226

Drill Bit..... 252

Drop Light..... 267

Duct Tape..... 258

Electric Tire Pump..... 19

Emergency Charger 223

Extension Cord..... 267

Extensions..... 242

Extractor Set 252

First Aid Kit..... 273

Flashlight..... 269

Flex Socket 239

Floor Jack..... 265

Folding Knife 255

Funnel 229

Fuse Assortment 259

Gasket Scraper 255

Grease Gun..... 40, 225, 289

Hammer 256

Hardware Assortments..... 259

Heat Shrink 250

Hex Bit Sockets..... 245

Impact Driver..... 248

Jack Stand 265

Key Type Hose Clamp 261

Laser Pointer..... 269

Lug Wrench..... 19, 271

Magnetic Retriever 254

Magnetic Tray 254

Mechanic Gloves..... 273

Mini Fuse Assortment 259

Mini Grease Gun..... 289

Mini Sledge 256

Multi Tool..... 247

Multimeter 219

Multi-Purpose Lift 265

Nut Assortment 259

Nut Splitter 252

Oil Filter Pliers..... 226

Oil Filter Wrench 226

Penlight 269

Pick 252

Plastic Bins..... 262

Pliers 250

Pocket Flashlight..... 268

Pocket Screwdriver 247

Portable Air Tank 265

Portable Led Work Light..... 268

Punch Set..... 249

Ratchet..... 238

Ratchet Strap 214

Razor Blades..... 255

Riveter Set 252

Roll Around Stool 266

Rolling Work Seat 266

Rubber Cement..... 271

Rubber Mallet..... 256

Scraper..... 255

Screw Assortment 259

Screwdriver 248

Screwdriver Set..... 248

Seal Pick 252

Snap Ring Assortment 259

Socket Adapter..... 241

Socket Rail..... 238

Sockets 243-244

Soldering Gun 250

Soldering Kit..... 250

Spark Tester..... 220

Spotlight 268

Stainless Polish Kit..... 267

Stapler 258

Star Bit Sockets..... 245

Step Drill Set 252

Stubby Bit Driver 248

Suction Gun 225

Swivel Mirror 254

T Handle Hex Key Set..... 246

Tape Measure..... 256

Thin Wall Socket 244

Tire Gauges 19

Tire Hardware Kit 271

Tire Kits 20

Tire Pressure Gauge..... 216

Tire Repair Kit 271

Tool Bag..... 267

Tubeless Tire Repair Plugs..... 20

U-Joint Socket..... 239

Utility Knife 255

Voltage Checker..... 219

Washer Assortment..... 259

Wire Brush 257

Wire Pliers..... 251

Wobble Extension Set..... 242

Work Light 268

Zip Ties 258

Perma-Lock Threadlocker

JB Weld..... 285

Permatex

Anti Seize Lubricant 288

Battery Cleaner 286

Blue Silicone 288

Brake Cleaner 286

Engine Degreaser 286

Fast Orange 287

Hand Cleaner..... 287

Hand Soap 287

Non-Chlorinated Brake Clean 288

Thread Lock Gel..... 288

Thread Locker 288

Ultra Black 288

White Lithium Grease..... 286

Peterson

Auxiliary Light..... 98

Back Up Light..... 76-99

Clearance Lights 76-99

Flasher 76-99

Flasher Relay 76-99

Flood Light 95

Fog Light Kit 95

Halogen Work Light..... 97

License Plate Bracket 99

Marker Light 76-99

Micro Strobe Light..... 93

Mini Light Bar 76-99

Off-Road Light..... 95

Plate Light 76-99

Plugs 76-99

Reflector Kit..... 76-99

Reflector Marker..... 76-99

Replacement Grommets 76-99

Stop Light 76-99

Submersible Light Bar.....76-99
 Submersible Light Kit.....76-99
 Tractor Light.....97
 Turn Light.....76-99
 Universal Mounting Bracket.....76-99
 Universal Trailer Light Kit.....76-99
 Utility/Porch Light.....98
 Work Light.....97

Pick
 Performance Tool.....252

Pintle Hook
 Buyers.....68-69

Pintle Hook Bolt Kit
 Buyers.....67

Pintle Hook Mount
 Buyers.....67

Pivot Point
 Hair Pin.....180

PJ1
 Brake Cleaner.....276
 Contact Cleaner.....276
 Leather Renew And Protect.....276
 Spray Wash.....276
 Super Cleaner.....276

Plastic Bins
 Performance Tool.....262

Plastic Weld Epoxy
 JB Weld.....282

Plate Light
 Blazer.....77-99
 Peterson.....76-99

Pliers
 Performance Tool.....250

Plug And Play Adaptors
 Hopkins.....111

Plugs
 Peterson.....76-99

Pocket Flashlight
 Performance Tool.....268

Pocket Screwdriver
 Performance Tool.....247

Polymer Step
 Buyers.....50

Portable Air Tank
 Performance Tool.....265

Portable LED Work Light
 Performance Tool.....268

Power Outlet
 SPI.....223

Powered Jack
 Bulldog.....46

Prop Rod
 Caliber.....193

Protectant Cleaner And Polish
 Hardline.....278

Pulse Preventer
 Tow Ready.....142

Punch Set
 Performance Tool.....249

Push To Test Breakaway System
 Tekonsha.....143

Q

Quick Connect Plugs
 Blazer.....77-86

Quick Epoxy
 JB Weld.....282

Quick Link
 Buyers.....70

Quick Snowmobile Tie Down
 Just Sail.....194

R

Racing Light
 Risk.....263

Ramp Glide Kit
 Caliber.....188

Ramp Plate
 Erickson.....185

Ramp Plate Kit
 Buyers.....185

Ramp Shield
 Caliber.....190

Rat Pak
 Ancra.....206

Ratchet
 Performance Tool.....238

Ratchet Strap
 Ancra.....206
 Buyers.....214
 Erickson.....206-209
 Highlands.....213
 Performance Tool.....214

Ratio Rite.....228

Razor Blades
 Performance Tool.....255

RCA Jack Splitter
 SPI.....223

Receiver Extension
 Buyers.....63

Receiver Hook
 Buyers.....68

Receiver Locks
 Tow Ready.....178

Receiver Pin
 Tri-Max.....168

Receiver Step
 Buyers.....63

Receiver Tube
 Buyers.....62-63

Receiver Tube Adaptor
 Buyers.....62-63

tires & wheels

axles, hubs & springs

tongue accessories

hitches

electrical

brake parts

trailer hardware

locks & pins

towing & loading

tie downs

tools

chemicals

SEE ORDERING DIFFERENTLY:
 Various Ordering Options
 Convenient 24/7 On-Line Management
 An Extensive Inventory

Same day and Saturday Shipping

AUTOMATIC DISTRIBUTORS
www.autodist.com

TRAILER

- tires & wheels
- axles, hubs & springs
- tongue accessories
- hitches
- electrical
- brake parts
- trailer hardware
- locks & pins
- towing & loading
- tie downs
- tools
- chemicals

TRAILER

Receiver Tube Cover
Reese 64

Receiver Tube Light
Reese 64

Recessed Ring
Buyers 160

Recovery Strap
Erickson 210

Reese
Brake Controller 137
Circuit Tester 105
Hitch Ball Wrench 72
Receiver Tube Cover 64
Receiver Tube Light 64
Retractable Wire Adaptor 105

Reflector Kit
Peterson 76-99

Reflector Marker
Optronics 75-90
Peterson 76-99

Reflectors
Optronics 75-92

Reliable
Axle 22
Axle Hanger Kit 39
Axle Nut 23
Brake Drum 158
Brake Rotor 158
Cotter Pin 23
Equalizer Kit 39
Hydraulic Brake Assemblies 157
Round Axle 22
Spindle 25
Spindle Parts 23
Spindle Washer 22
Spring Seat 22
Studs 24
Tandem Axle Hanger Kit 39
Tube Axle 22
U-Bolt Kits 35
Wheel Stud 24

Replacement Ball 56

Replacement Bulbs
Candlepower 98

Replacement Grommets
Peterson 76-99

Replacement Shank 56

Retractable Ratchet Strap
Erickson 207
Highlands 213

Retractable Strap
Caliber 191

Retractable Wire Adaptor
Reese 105

Rib Roller
Smith 201

Ride-On
Liquid Tire Balance 277
Smart Caps 277
Tire Sealant 277

Risk
Flexit Headlamp 264
Magnetic Light 263
Mobile Task Light 264
Racing Light 263
Risk Jug Mount 263
Risk Racing Jugs 263
Shoplight 264

Risk Jug Mount
Risk 263

Risk Racing Jugs
Risk 263

Riveter Set
Performance Tool 252

Roll Around Stool
Performance Tool 266

Roller
Smith 200-201

Roller Bracket
Smith 201-203

Roller Bunk
Smith 203

Roller End Cap
Smith 201

Roller Shaft
Smith 202

Rolling Work Seat
Performance Tool 266

Rope Ratchet
Erickson 214

Round Axle
Reliable 22

RTV Sealant
Threebond 280

Rubber Adhesive
Threebond 280

Rubber Cement
Performance Tool 271

Rubber Handle Tie Downs
Erickson 206-209

Rubber Mallet
Performance Tool 256

Rubber Mat 192

Rubber Tarp Strap
Erickson 212

RV Blade Connectors
Hopkins 109

RZ
Safety Glasses 273
Tinted Safety Glasses 273

S

Sealed Battery
Tekonsha 143

Shackle Bolts
Tie Down 38

Shackle Lock
Tri-Max 174

Shackles
Buyers 163

Shaker Siphon
Flo Tools 227

Shielded Padlock
Tri-Max 175

Shipsape
Hub Kits 24
Wheel Bolts 24
Wheel Nuts 24

S-Hook
Smith 163

Shoplight
Risk 264

Side Roller
Smith 201

Silicone Liquid Gasket
Threebond 280

Silicone Sealant
Threebond 280

Siphon Pump 227

Ski Tie Down Bar 197

Ski Track
Caliber 187

Slipper Spring 26

Smart Caps
Ride-On 277

Smith
Adjustable Keel Roller Bracket 200
Angle Bracket 200
Angled Bunk Bracket 202
Axle Tie Plate 36
Bow Bell Roller 201
Bow Roller 201
Bow Stop 201
Bunk Bracket 202
Bunk Carpet 203
Bunk Guide On 204
Fender Brackets 16
Frame Straps 37
Jon Boat Front Support 204
Keel Pad 201
Keel Roller 200-201
Keel Roller Bracket 202
Metal Fenders 16
Pal Nuts 202
Rib Roller 201
Roller 200-201
Roller Bracket 201-203
Roller Bunk 203
Roller End Cap 201
Roller Shaft 202
S Hook Keeper 70
Safety Chains 70
Safety Hook 70
S-Hook 163
Side Roller 201
Snap Hook 199
Spare Tire Cover 18
Spring Hanger 38
Swivel Bracket 202
Tail Light Bracket 202
Thermal Plastic Rubber Roller 201
Tire Cover 18
Zinc Plated U Bolts 35

Snap Hook	
Smith.....	199
Tie Down.....	199
Snap Ring Assortment	
Performance Tool.....	259
Snowmobile Tie Down System	
Just Sail.....	194
Socket Adapter	
Performance Tool.....	241
Socket Rail	
Performance Tool.....	238
Sockets	
Performance Tool.....	243-244
Soft Hook Extension	
Ancra.....	206
Soldering Gun	
Performance Tool.....	250
Soldering Kit	
Performance Tool.....	250
Spare Tire Carrier	
Fulton.....	17
Spare Tire Cover	
Smith.....	18
Spark Tester	
Performance Tool.....	220
SPI	
12V Outlet.....	223
Cable Ties.....	258
Power Outlet.....	223
RCA Jack Splitter.....	223
Spring Hook.....	253
Tie Down Strap.....	214
Spindle	
Reliable.....	25
Tie Down.....	25
Spindle Nut	23
Spindle Parts	
Reliable.....	23
Spindle Washer	
Reliable.....	22
Spotlight	
Performance Tool.....	268
Spray Wash	
PJ1.....	276
Spring	26-27
Spring Bushings	27
Spring Hanger	
Smith.....	38
Tie Down.....	38
Spring Hook	
SPI.....	253
Spring Latch	
Buyers.....	200
Spring Seat	
Reliable.....	22
Spring Sliders	38
Spring Tool	253
Square Jack	
Bulldog.....	47
Buyers.....	45
Stainless Convert-A-Ball	56
Stainless Disc Brakes	
Tie Down.....	156
Stainless Polish Kit	
Performance Tool.....	267
Stainless Steel Locking Pin	
Tri-Max.....	166
Stainless Steel Ratchet Strap	
Highlands.....	213
Stake Pocket	
Buyers.....	163
Stake Pocket Anchor	
Erickson.....	160
Stapler	
Performance Tool.....	258
Star Bit Sockets	
Performance Tool.....	245
Step Drill Set	
Performance Tool.....	252
Sticker Off	
Hardline.....	278
Sticker On	
Hardline.....	278
Stop Light	
Buyers.....	74
Optronics.....	75-90
Peterson.....	76-99
Stop Watch	
Hardline.....	221
Stop/Turn/Tail Lights	
Optronics.....	75-90
Storage Boxes	
Buyers.....	50
Storage Containers	
VP Racing.....	231-232
Strap Hanger	
Erickson.....	211
Strobe Light	
Buyers.....	93
Stroker	
Trigger Hose.....	233
Stubby Bit Driver	
Performance Tool.....	248
Studs	
Reliable.....	24
Submersible Light Bar	
Peterson.....	76-99
Submersible Light Kit	
Optronics.....	75-90
Peterson.....	76-99
Wes Barg.....	78-102
Suction Gun	
Performance Tool.....	225
Super Clamp	
Channel Track.....	196
Super Clamp.....	195-197
Super Glides.....	197
Super Glides Wide.....	197
Super Track.....	196
Trailer Glides.....	197
Super Cleaner	
PJ1.....	276
Super Glides	
Super Clamp.....	197
Super Glides Wide	
Super Clamp.....	197
Super Glue	
Threebond.....	280
Super Track	
Super Clamp.....	196
Surface Mount Ring	
Buyers.....	161
Erickson.....	161
Suspa	
Covered Trailer Props.....	195
Gas Prop.....	195
Swing Away Jack	
Buyers.....	44
Swivel Bracket	
Smith.....	202
Swivel Jack	
Bulldog.....	46-47
Buyers.....	44
Fulton.....	42-43
Swivel Mirror	
Performance Tool.....	254
Syphon Hose	227

T

T Handle Hex Key Set	
Performance Tool.....	246
T Handle Rack	
Motion Pro.....	237
T Handle Spinner Wrench	
Motion Pro.....	236
T Handle Wrench	
Motion Pro.....	236-237
Tail Light Bracket	
Smith.....	202
Tail Light Converter	
Hopkins.....	123-124
Tail Light Kit	
Wes Barg.....	78-102
Taillight Converter	
Draw Tite.....	123
Tandem Axle Hanger Kit	
Reliable.....	39
Tape Measure	
Performance Tool.....	256
Tekonsha	
7-Way Emulator.....	135
Alko Brake Parts.....	150
Battery Cases.....	143
Brake Control Wiring Harness.....	139-141
Brake Controller.....	135-136
Brake Controller Install Kit.....	142
Brake Magnets.....	149
Breakaway Switch.....	144
Breakaway Systems.....	143
Circuit Breaker.....	144
Dexter Brake Parts.....	151-153
Electric Brake Assemblies.....	157
Electrical Contact Grease.....	144
Fayette Brake Parts.....	155-156
Hayes Brake Parts.....	153-155
Magnet Kits.....	149
Push To Test Breakaway System.....	143
Sealed Battery.....	143
Tera Pump	
Fuel Transfer Pumps.....	234-235
Tera Pumps	
Drum Pump.....	235
Thermal Plastic Rubber Roller	
Smith.....	201
Thin Line Tail Light	
Optronics.....	75-90
Thin Wall Socket	
Performance Tool.....	244
Thread Lock Gel	
Permatex.....	288
Thread Locker	
Permatex.....	288
Threebond.....	281
Threaded Link Tie Down	71
Threebond	
Gasket Maker.....	280
Glue.....	280
Grip Lock.....	280
Hi Temp Thread Locker.....	281
RTV Sealant.....	280
Rubber Adhesive.....	280
Silicone Liquid Gasket.....	280
Silicone Sealant.....	280
Super Glue.....	280
Thread Locker.....	281

tires & wheels
axles, hubs & springs
tongue accessories
hitches
electrical
brake parts
trailer hardware
locks & pins
towing & loading
tie downs
tools
chemicals

TRAILER

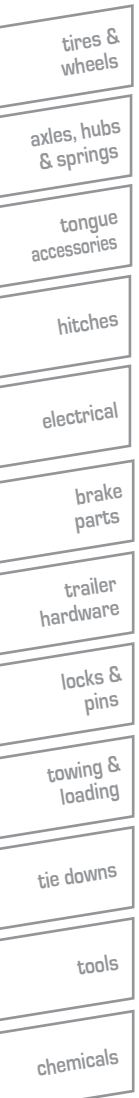

Tie Down			
Bearing Protector	30	Tire Tubes	
Bow Safety Chain.....	199	Carlisle	14
Brake Drum Hub	158	Tires	
Disc Brake Kit.....	156	Load Star.....	10-11, 13
Disc Brake Upgrade Kit.....	156	Titanium Wrenches	
Fender Brackets.....	16	Motion Pro.....	249
Heavy Duty Spare Tire Carrier.....	17	TMV	
Hitch Cable.....	71	Safety Wire.....	251
Latch Hook.....	71	Tire Pressure Gauge.....	216
Lock Nuts	34	Toggle Switch	
Safety Cable.....	71	Blazer.....	77-86
Safety Chains.....	71	Tongue Box	
Shackle Bolts	38	Buyers	50
Snap Hook	199	Tool Bag	
Spindle.....	25	Performance Tool.....	267
Spring Hanger.....	38	Tool Boxes	
Stainless Disc Brakes	156	Buyers	50
Threaded Link	71	Top Wind Jack	
Tie Down Plate.....	36	Buyers	45
Tie Down Plate Kit.....	37	Tow Balls	54-56
U-Bolt Kits	33	Tow Connector	
U-Bolts	32-33	Fulton	123
Washers.....	34	Tow Hooks	
Winch Cable.....	199	Erickson	164
Winch Strap.....	199	Tow Light Kit	
Tie Down Anchor		Buyers	94
Erickson	161	Wes Barg	78-102
Tie Down Crank	197	Tow Mirror	
Tie Down Handle	197	Cipa.....	182-183
Tie Down Plate		Tow Ready	
Tie Down	36, 197	5-Wire Flat Harness	106
Tie Down Plate Kit		7-Way Extension	105
Tie Down	37	Connector Mount Bracket	103-104
Tie Down Ring		Flat Wire Dust Cover.....	106
Erickson	160	Fuse Holders.....	130
Tie Down Strap		Hitch Alignment.....	18
Ankra.....	206	Interchangeable Ball System	55
Erickson	206-209	Pulse Preventer.....	142
SPI	214	Receiver Locks	178
Tie Down System		Tow Ropes	
Just Sail.....	194	Erickson	210
Tie Hooks		Tow Shackle	
Erickson	163	Buyers	68
Tightening Bar		Towing Hook	
Erickson	212	Buyers	68
Tilt-Ez		Track Saver	
Just Sail.....	194	Caliber.....	189
Tinted Safety Glasses		Traction Litter	
RZ Industries.....	273	Caliber.....	188
Tire Cover		Traction Mat	192
Smith.....	18	Tractor Light	
Tire Gauges		Optronics.....	97
Performance Tool.....	19	Peterson.....	97
Tire Hardware Kit		Trailer Ball	
Performance Tool.....	271	Buyers	54
Tire Inflator Kit		Trailer Bearing	30-31
Bronco.....	271	Trailer Glides	
Tire Irons		Caliber.....	187
Motion Pro.....	20	Super Clamp	197
Tire Kits		Trailer Jack	42-48
Performance Tool.....	20	Trailer Light Kit	
Tire Pressure Gauge		Optronics.....	75-90
Emgo.....	216	Trailer Prop	
Performance Tool.....	216	Caliber.....	193
TMV.....	216	Trailer Slides	
Tire Repair Kit		Caliber.....	187
Performance Tool.....	271	Trailer Spray Shield	
Tire Sealant		Caliber.....	190
Ride-On.....	277	Trailer Tie Down Bar	197
Tire Strap		Trailer Tilt Prop	
Erickson	272	Enforcer.....	195
		Trailer Winch	
		Buyers	198
		Fulton	198
		Transmission Funnel	
		Flo Tools	230
		Transom Tie Down	
		Erickson	210
		Transom/Bow Eyelet	
		Erickson	212
		Trax Grabber	
		Caliber.....	189
		Traxmat	
		Caliber.....	189
		Tri-Ball Mount	
		Buyers	61
		Tri-Ball With Hook	
		Buyers	61
		Trigger Hose	
		Stroker.....	233
		Tri-Max	
		5th Wheel Lock	171
		Adjustable Hitch.....	61
		Alarm Lock Cable.....	173
		Braided Cable	172
		Cable Lock	172-174
		Coupler Locks	170
		Door Hasp	175
		Flip-Tip Pins	168
		Floor Anchor Kit	171
		Hardened Locking Pin.....	169
		Hitch Locks.....	166-169
		Lock Pins.....	166-169
		Marine Grade Padlock	175
		Outboard Lock.....	171
		Receiver Pin.....	168
		Shackle Lock.....	174
		Shielded Padlock	175
		Stainless Steel Locking Pin.....	166
		Weatherproof Padlock.....	175
		Wheel Lock	171
		Wheel Locks.....	18
		Tube Axle	
		Reliable	22
		Tube Mount Jack	
		Buyers	44
		Tubeless Tire Repair Plugs	
		Performance Tool.....	20
		Turn Light	
		Buyers	74
		Optronics.....	75-90
		Peterson.....	76-99

U

U-Bolt Kits	
Reliable	35
Tie Down	33
U-Bolts	
Tie Down	32-33
U-Joint Socket	
Performance Tool	239
Ultimate Black Silicone	
JB Weld	284
Ultra Black	
Permatex	288
Universal Mounting Bracket	
Peterson	76-99
Universal Trailer Light Kit	
Optronics	75-90
Peterson	76-99
Utility Knife	
Performance Tool	255
Utility Light	
Buyers	74
Utility/Porch Light	
Peterson	98

V

Valve Spring Compressor	
Motion Pro	218
Valve Spring Tool	
Motion Pro	218
Valve Stem	
Carlisle	14
Vehicle Specific Multi-Tow Connector	
Hopkins	125-129
Vehicle Specific Wiring Kit	
Hopkins	113-117
Vent Cap	
VP Racing	232
Voltage Checker	
Performance Tool	219
VP Racing	
Container Cap	232
Container Hose	232
Containers	231-232
Storage Containers	231-232
Vent Cap	232

W

Washer Assortment	
Performance Tool	259
Washers	
Tie Down	34
Water Removing Funnel	
Mr. Funnel	228
Waterproof Grease	
ACF-50	279
Maxima	276
Waterproof/Submersible Tail Lights	
Wes Barg	78-102
Waterweld Epoxy	
JB Weld	283
Weatherproof Padlock	
Tri-Max	175
Web Protector	
Erickson	212
Wes Barg	
12V Corded Magnetic Work Light	96
4-Way Wire Harness	107
5-Wire Flat Harness	106
6-Way Connector	102
7-Way Connector	102
Clearance Lights	78-102
Coiled 4-Way Connector	107
Connector Mount Bracket	103
LED Work Light	96
Marker Light	78-102
Micro Marker Light	78-102
Submersible Light Kit	78-102
Tail Light Kit	78-102
Tow Light Kit	78-102
Waterproof/Submersible Tail Lights	78-102
Wheel Bolts	
Shipshape	24
Wheel Hub	23-24
Wheel Lock	
Buyers	176
Tri-Max	171
Wheel Locks	
Tri-Max	18
Wheel Nuts	
Shipshape	24
Wheel Stud	
Reliable	24
White Lithium Grease	
Lubrimatic	290
Permatex	286
White Silicone	
JB Weld	284
Winch	198
Winch Cable	
Tie Down	199
Winch Hook	
Fulton	199
Winch Mount	
Draw Tite	72
Winch Receiver Mount	
Draw Tite	72
Winch Strap	
Erickson	214
Tie Down	199
Wire Brush	
Performance Tool	257
Wire Pliers	
Performance Tool	251
Wireless Light Management System	
Blazer	77-86

Wireless Tow Light Kit	
Blazer	77-86
Wiring Harness	
Blazer	77-86
Wiring Installation Kit	
Hopkins	124-125
Wobble Extension Set	
Performance Tool	242
Wood Weld Epoxy	
JB Weld	282
Work Light	
Performance Tool	268
Peterson	97

Y

Yuasa	
Jumper Cables	219

Z

Zinc Plated U Bolts	
Smith	35
Zip Ties	
Performance Tool	258

tires & wheels
axles, hubs & springs
tongue accessories
hitches
electrical
brake parts
trailer hardware
locks & pins
towing & loading
tie downs
tools
chemicals

TRAILER

FULTON



PROUDLY DISTRIBUTED BY

**AUTOMATIC
DISTRIBUTORS**

Fulton is the industry leader for high performance jacks designed for marine, recreational and utility trailers. Fulton jacks feature maintenance free designs, corrosion resistant components, and ergonomic centered features for ease of use and utmost durability.